

FEATURES

- High integration**
- 32-channel, 14-bit *denseDAC*® with integrated high voltage output amplifier
- Guaranteed monotonic**
- Housed in 15 mm × 15 mm CSP_BGA package**
- Full-scale output voltage programmable from 50 V to 200 V via reference input**
- 550 µA drive capability**
- Integrated silicon diode for temperature monitoring**
- DSP-/microcontroller-compatible serial interface**
- 1.2 MHz channel update rate**
- Asynchronous RESET facility**
- 10°C to +85°C temperature range**

APPLICATIONS

- Optical microelectromechanical systems (MEMS)
- Optical crosspoint switches
- Micropositioning applications using piezoelectric actuators
- Level setting in automotive test and measurement

GENERAL DESCRIPTION

The **AD5535B** is a 32-channel, 14-bit *denseDAC*® with an on-chip high voltage output amplifier. This device is targeted for optical micro-electromechanical systems. The output voltage range is programmable via the REF_IN pin. The output range is 0 V to 50 V when REF_IN = 1 V, and 0 V to 200 V when REF_IN = 4 V. Each amplifier can source 550 µA, which is ideal for the deflection and control of optical MEMS mirrors.

The selected digital-to-analog converter (DAC) register is written to via the 3-wire interface. The serial interface operates at clock rates of up to 30 MHz and is compatible with DSP and microcontroller interface standards.

The device is operated with AV_{CC} = 4.75 V to 5.25 V, DV_{CC} = 2.7 V to 5.25 V, V₊ = 4.75 V to 5.25 V, and V_{PP} of up to 225 V. REF_IN is buffered internally on the **AD5535B** and should be driven from a stable reference source.

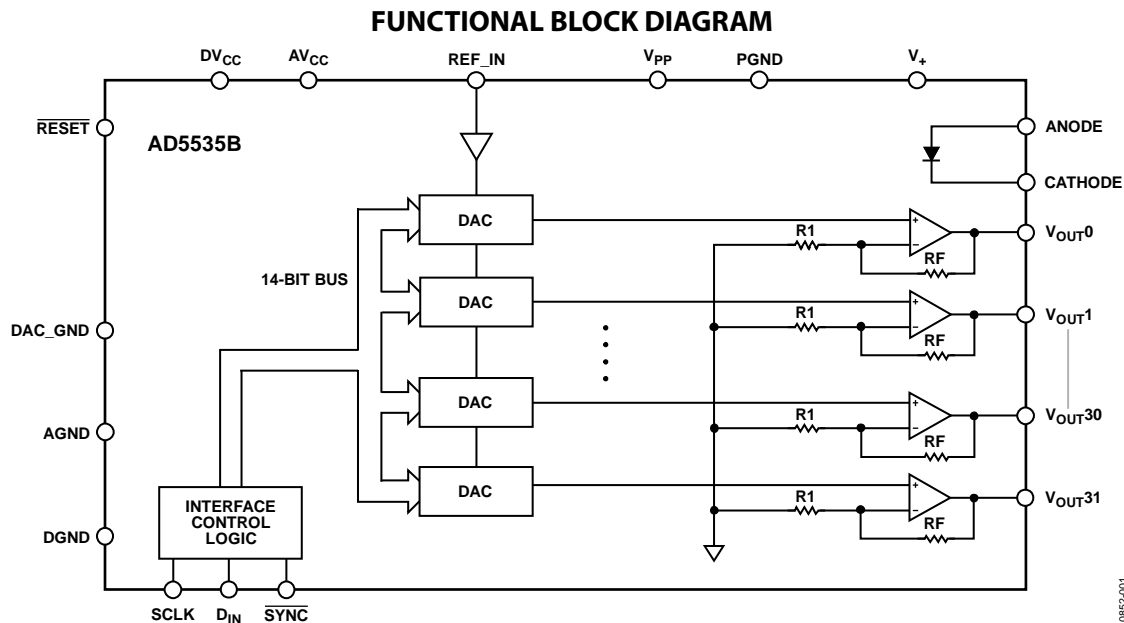

Figure 1.

10852-001

TABLE OF CONTENTS

Features	1	DAC Section	12
Applications.....	1	Reset Function	12
General Description	1	Serial Interface	12
Functional Block Diagram	1	Microprocessor Interfacing.....	12
Revision History	2	Applications.....	14
Specifications.....	3	MEMS Mirror Control Application	14
Timing Characteristics	5	IPC-2221-Compliant Board Layout.....	14
Absolute Maximum Ratings.....	6	Power Supply Decoupling Recommendations.....	15
ESD Caution.....	6	Guidelines for Printed Circuit Board Layout.....	15
Pin Configuration and Function Descriptions.....	7	Outline Dimensions	16
Typical Performance Characteristics	9	Ordering Guide.....	16
Terminology	11		
Functional Description	12		

REVISION HISTORY

4/13—Rev. 0 to Rev. A

Change to General Description Section	1
Changes to DAC Section	12
Changes to MEMS Mirror Control Application Section	14

1/13—Revision 0: Initial Version

SPECIFICATIONS

$V_{PP} = 215\text{ V}$; $V_+ = 5\text{ V}$; $AV_{CC} = 5.25\text{ V}$; $DV_{CC} = 2.7\text{ V to }5.25\text{ V}$; $PGND = AGND = DGND = DAC_GND = 0\text{ V}$; $REF_IN = 4.096\text{ V}$; all outputs unloaded. All specifications T_{MIN} to T_{MAX} , unless otherwise noted.

Table 1.

Parameter ¹	K Grade ²			Unit	Test Conditions/Comments
	Min	Typ	Max		
DC PERFORMANCE³					
Resolution		14		Bits	
Integral Nonlinearity (INL)		± 0.1		% of FSR	
Differential Nonlinearity (DNL)	-1	± 0.5	+1	LSB	Guaranteed monotonic
Zero Code Voltage		0.5	1	V	
Output Offset Error	-1		+1	V	
Offset Drift		0.5		mV/°C	
Voltage Gain	49	50	51	V/V	
Gain Temperature Coefficient		5		ppm/°C	Due to DAC
		-200		ppm/°C	Due to DAC and amplifier
Channel-to-Channel Gain Match ⁴	-5		+5	%	
OUTPUT CHARACTERISTICS					
Output Voltage Range ³	1		$V_{PP} - 1$	V	
Output Impedance		50		Ω	
Resistive Load ^{4, 5}	1			M Ω	
Capacitive Load ⁴			200	pF	
Short-Circuit Current		0.55		mA	
DC Crosstalk ⁴		3	4	LSB	
DC Power Supply Rejection (PSRR), V_{PP}		70		dB	
Long-Term Drift		0.25		LSB	Outputs at midscale, measured over 30 days at 25°C
AC CHARACTERISTICS⁴					
Settling Time					
$\frac{1}{4}$ to $\frac{3}{4}$ Scale Step		60		μs	No load
		60		μs	200 pF load
1 LSB Step		5		μs	No load
		5		μs	200 pF load
Slew Rate		10		V/ μs	No load
		3		V/ μs	200 pF load
-3 dB Bandwidth	30			kHz	
Output Noise Spectral Density		4.5		$\mu\text{V}/\sqrt{\text{Hz}}$	Measured at 10 kHz
0.1 Hz to 10 Hz Output Noise Voltage		1		mV p-p	
Digital-to-Analog Glitch Impulse					1 LSB change around major carry
Positive Transition		15		nV-sec	
Negative Transition		8		nV-sec	
Analog Crosstalk		2.5		$\mu\text{V-sec}$	
Digital Feedthrough		2		nV-sec	
VOLTAGE REFERENCE, REF_IN⁶					
Input Voltage Range ⁴	1		4.096	V	AV_{CC} and V_+ must exceed REF_IN by 1.15V minimum
Input Impedance			60	k Ω	

Parameter ¹	K Grade ²			Unit	Test Conditions/Comments
	Min	Typ	Max		
TEMPERATURE MEASUREMENT DIODE ⁴					
Peak Inverse Voltage, P _{IV}			5	V	Cathode to anode
Forward Diode Drop, V _F		0.65	0.8	V	I _F = 100 μA, anode to cathode
Forward Diode Current, I _F			100	μA	Anode to cathode
V _F Temperature Coefficient, T _C		-2.20		mV/°C	Anode to cathode
DIGITAL INPUTS ⁴					
Input Current		±5	±10	μA	
Input Low Voltage			0.8	V	
Input High Voltage	2.0			V	
Input Hysteresis (SCLK and $\overline{\text{SYNC}}$ Only)		200		mV	
Input Capacitance			10	pF	
POWER SUPPLY VOLTAGES					
V _{PP}	(50 × REF_IN) + 1		225	V	
V ₊	4.75		5.25	V	
A _{VCC}	4.75		5.25	V	
D _{VCC}	2.7		5.25	V	
POWER SUPPLY CURRENTS ⁷					
I _{PP}					
All Channels at Full-Scale		50	60	μA/channel	
All Channels at Zero-Scale		25	35	μA/channel	
I ₊		1.2	1.7	mA	
A _{I_{CC}}		17.5	20	mA	
D _{I_{CC}}		0.25	0.6	mA	

¹ See the Terminology section.

² K Grade temperature range: -10°C to +85°C; typical = +25°C.

³ Linear output voltage range: 7 V to V_{PP} - 1 V.

⁴ Guaranteed by design and characterization, not production tested.

⁵ Ensure that T_J max is not exceeded. See the Absolute Maximum Ratings section.

⁶ Reference input determines output voltage range. Using a 4.096 V reference (REF198) gives an output voltage range of 2.50 V to 200 V. The output range is programmable via the reference input. The full-scale output range is programmable from 50 V to 200 V. The linear output voltage range is restricted from 7 V to V_{PP} - 1 V.

⁷ Outputs unloaded.

TIMING CHARACTERISTICS

$V_{PP} = 210\text{ V}$; $V_+ = +5\text{ V}$; $AV_{CC} = 5.25\text{ V}$; $DV_{CC} = 2.7\text{ V to } 5.25\text{ V}$; $AGND = DGND = DAC_GND = 0\text{ V}$; $REF_IN = 4.096\text{ V}$. All specifications T_{MIN} to T_{MAX} , unless otherwise noted.

Table 2.

Parameter ^{1, 2, 3}	A Grade	Unit	Test Conditions/Comments
f_{UPDATE}	1.2	MHz max	Channel update rate
f_{CLKIN}	30	MHz max	SCLK frequency
t_1	13	ns min	SCLK high pulse width
t_2	13	ns min	SCLK low pulse width
t_3	15	ns min	\overline{SYNC} falling edge to SCLK falling edge setup time
t_4	50	ns min	\overline{SYNC} low time
t_5	10	ns min	\overline{SYNC} high time
t_6	10	ns min	D_{IN} setup time
t_7	5	ns min	D_{IN} hold time
t_8	200	ns min	19 th SCLK falling edge to \overline{SYNC} falling edge for next write
t_9	20	ns min	\overline{RESET} pulse width

¹ See Figure 2.

² Guaranteed by design and characterization, not production tested.

³ All input signals are specified with $t_r = t_f = 5\text{ ns}$ (10% to 90% of DV_{CC}) and timed from a voltage level of $(V_{IL} + V_{IH})/2$.

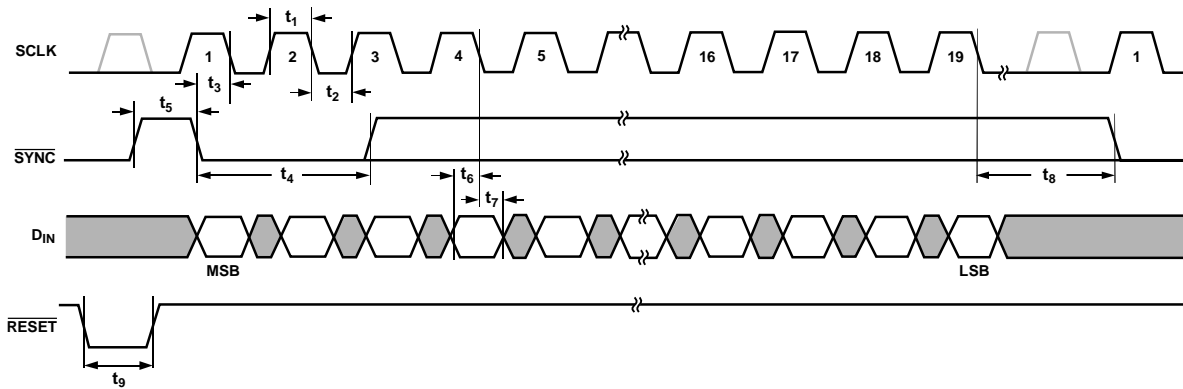

Figure 2. Serial Interface Timing Diagram

10862-002

ABSOLUTE MAXIMUM RATINGS

$T_A = 25^\circ\text{C}$, unless otherwise noted.

Table 3.

Parameter	Rating
V_{PP} to AGND	0.3 V to 240 V
V_i to AGND	-0.3 V to +7 V
AV_{CC} to AGND, DAC_GND	-0.3 V to +7 V
DV_{CC} to DGND	-0.3 V to +7 V
Digital Inputs to DGND	-0.3 V to $DV_{CC} + 0.3$ V
REF_IN to AGND, DAC_GND	-0.3 V to $AV_{CC} + 0.3$ V
V_{OUT0} to V_{OUT31} to AGND	-0.3 V to $V_{PP} + 0.3$ V
ANODE/CATHODE to AGND, DAC_GND	-0.3 V to +7 V
AGND to DGND	-0.3 V to +0.3 V
Operating Temperature Range	
Industrial	-10°C to +85°C
Storage Temperature Range	-65°C to +150°C
Junction Temperature (T_J max)	150°C
124-Lead CSP_BGA Package, θ_{JA} Thermal Impedance	40°C/W
Lead Temperature	JEDEC industry standard
Soldering	J-STD-020
ESD	
Human Body Model	2.5 kV
Machine Model	250 V
Field Induced Charged Device Model	400 V

Stresses above those listed under Absolute Maximum Ratings may cause permanent damage to the device. This is a stress rating only; functional operation of the device at these or any other conditions above those indicated in the operational section of this specification is not implied. Exposure to absolute maximum rating conditions for extended periods may affect device reliability.

Transient currents of up to 100 mA do not cause SCR latch-up.

ESD CAUTION



ESD (electrostatic discharge) sensitive device. Charged devices and circuit boards can discharge without detection. Although this product features patented or proprietary protection circuitry, damage may occur on devices subjected to high energy ESD. Therefore, proper ESD precautions should be taken to avoid performance degradation or loss of functionality.

PIN CONFIGURATION AND FUNCTION DESCRIPTIONS

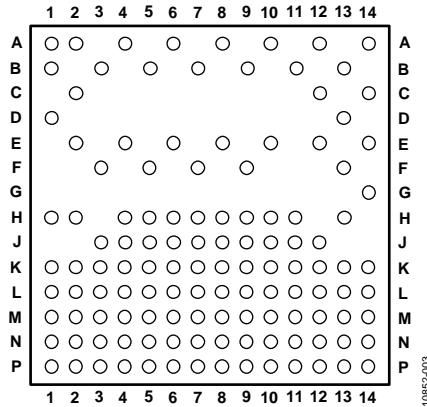

Figure 3. Pin Configuration

Table 4. Pin Assignments

Pin No.	Mnemonic	Pin No.	Mnemonic
A1	NC	H1	V _{PP}
A2	V _{out1}	H2	V _{PP}
A4	V _{out7}	H4 to H11	AGND
A6	V _{out11}	H13	V _{OUT27}
A8	V _{out16}	J3 to J12	AGND
A10	V _{out20}	K1	V ₊
A12	V _{out25}	K2	V ₊
A14	NC	K3 to K14	AGND
B1	V _{out0}	L1	NC
B3	V _{out4}	L2	NC
B5	V _{out9}	L3 to L13	AGND
B7	V _{out13}	L14	DAC_GND
B9	V _{out17}	M1 to M12	AGND
B11	V _{out21}	M13	AV _{CC}
B13	V _{out26}	M14	AV _{CC}
C2	V _{out3}	N1	PGND
C12	V _{out22}	N2	PGND
C14	V _{out29}	N3	CATHODE
D1	V _{out2}	N4	ANODE
D13	V _{out23}	N5 to N14	AGND
E2	V _{out5}	P1	NC
E4	V _{out8}	P2	REF_IN
E6	V _{out12}	P3	DAC_GND
E8	V _{out15}	P4	RESET
E10	V _{out19}	P5	DV _{CC}
E12	V _{out24}	P6	DGND
E14	V _{out31}	P7	TEST
F3	V _{out6}	P8	D _{IN}
F5	V _{out10}	P9	SCLK
F7	V _{out14}	P10	SYNC
F9	V _{out18}	P11 to P13	AGND
F13	V _{out30}	P14	NC
G14	V _{out28}		

Table 5. Pin Function Descriptions

Mnemonic	Description
AGND	Analog GND Pins.
AV _{CC}	Analog Supply Pins. Voltage range from 4.75 V to 5.25 V.
V _{PP}	Output Amplifier High Voltage Supply. Voltage range from (REF_IN × 50) + 1 V to 225 V.
V ₊	V ₊ Amplifier Supply Pins. Voltage range from 4.75 V to 5.25 V.
PGND	Output Amplifier Ground Reference Pins.
DGND	Digital GND Pins.
DV _{CC}	Digital Supply Pins. Voltage range from 2.7 V to 5.25 V.
DAC_GND	Reference GND Supply for All DACs.
REF_IN	Reference Voltage for Channel 0 to Channel 31. Reference input range is 1 V to 4 V and can be used to program the full-scale output voltage from 50 V to 200 V.
V _{OUT0} to V _{OUT31}	Analog Output Voltages from the 32 Channels.
ANODE	Anode of Internal Diode for Diode Temperature Measurement.
CATHODE	Cathode of Internal Diode for Diode Temperature Measurement.
$\overline{\text{SYNC}}$	Active Low Input. This is the frame synchronization signal for the serial interface. While $\overline{\text{SYNC}}$ is low, data is transferred in upon the falling edge of SCLK.
SCLK	Serial Clock Input. Data is clocked into the shift register upon the falling edge of SCLK. The pin operates at clock speeds of up to 30 MHz. Internal pull-up device on logic input; therefore, it can be left floating and defaults to a logic high condition.
D _{IN}	Serial Data Input. Data must be valid upon the falling edge of SCLK.
TEST	For normal operation, tie this pin low.
$\overline{\text{RESET}}$	Active Low Input. This pin can also be used to reset the complete device to its power-on reset conditions. Zero code is loaded to the DACs.
NC	No Connect. Do not connect to these pins.

TYPICAL PERFORMANCE CHARACTERISTICS

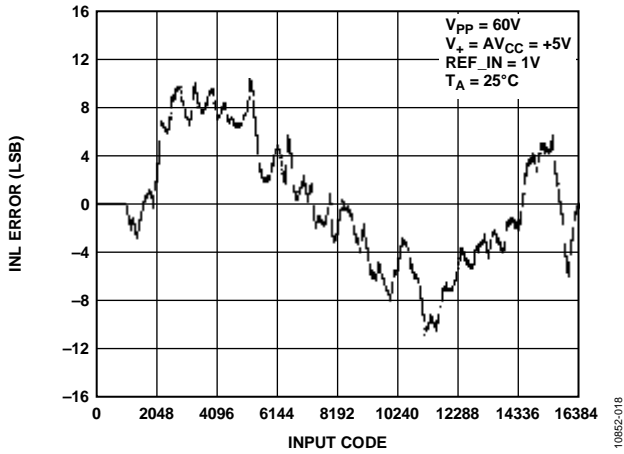

Figure 4. Integral Nonlinearity (INL) with Full-Scale Range = 50 V

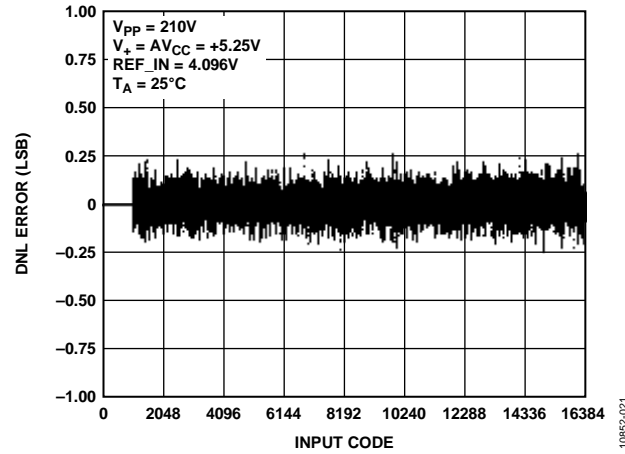

Figure 7. DNL with Full-Scale Range = 200 V

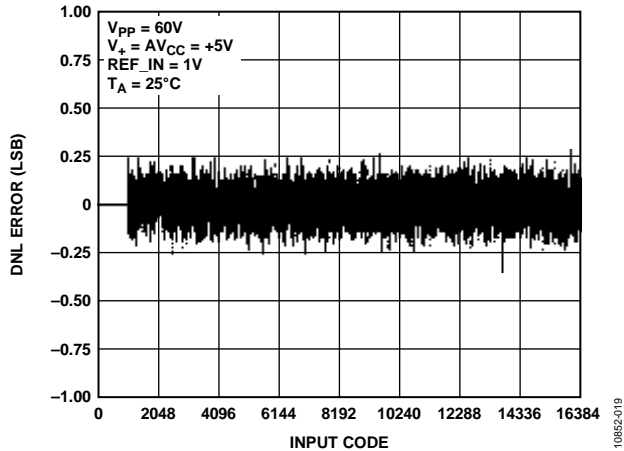

Figure 5. Differential Nonlinearity (DNL) with Full-Scale Range = 50 V

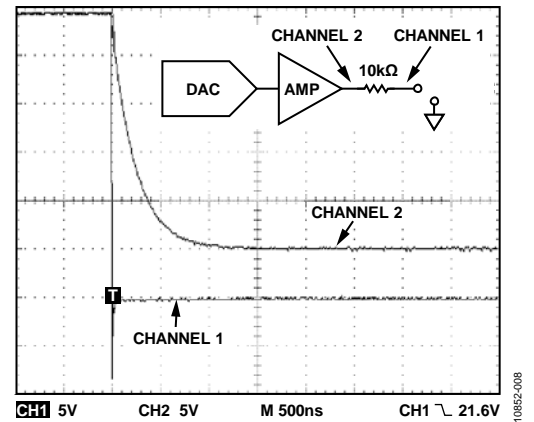

Figure 8. Short-Circuit Current Limit Timing

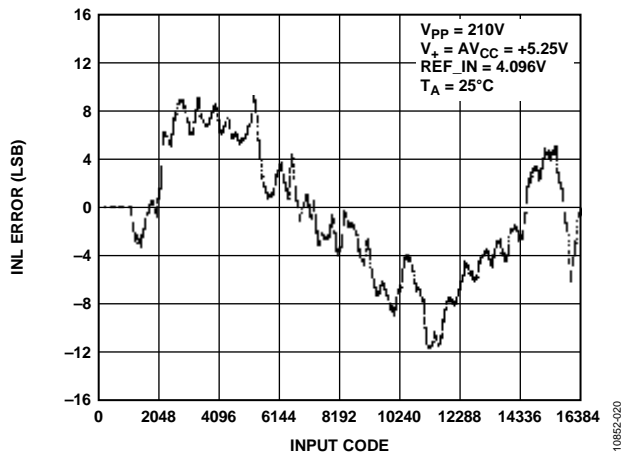

Figure 6. INL with Full-Scale Range = 200 V

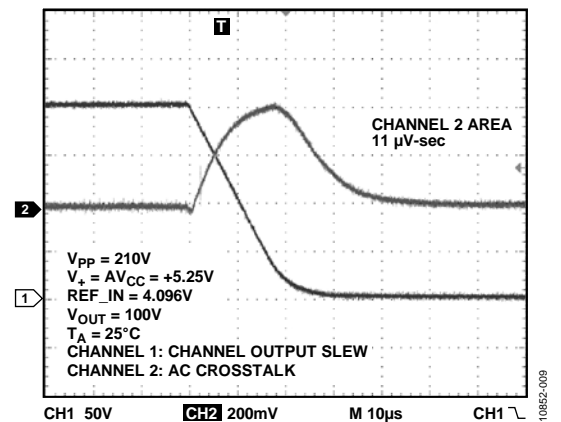

Figure 9. Worst-Case Adjacent Channel Crosstalk

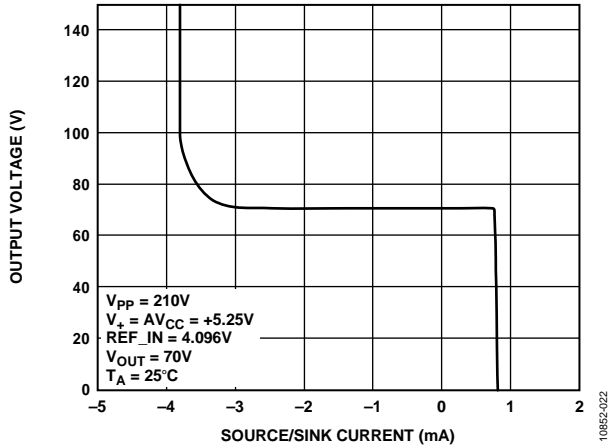

Figure 10. Output Amplifier Source and Sink Capability

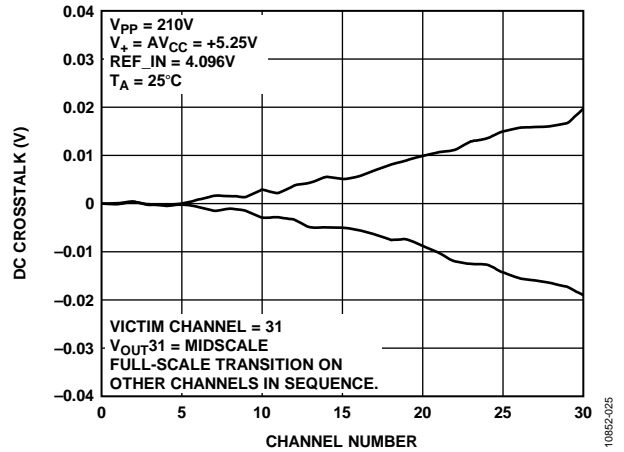

Figure 13. Cumulative DC Crosstalk Effects on a Single-Channel Output, Switching All Other Channels in Sequence

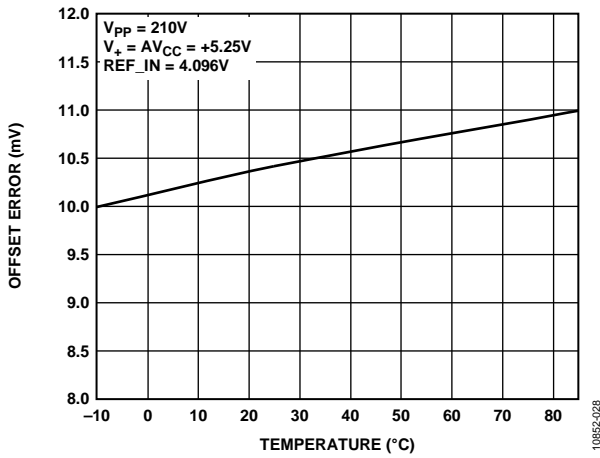

Figure 11. Offset Error vs. Temperature

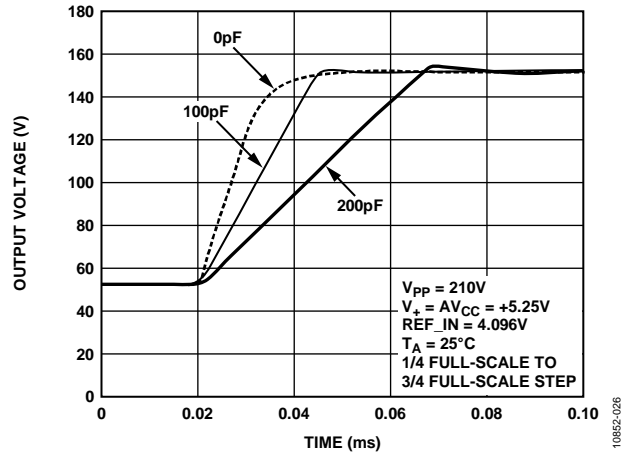

Figure 14. Settling Time vs. Capacitive Load

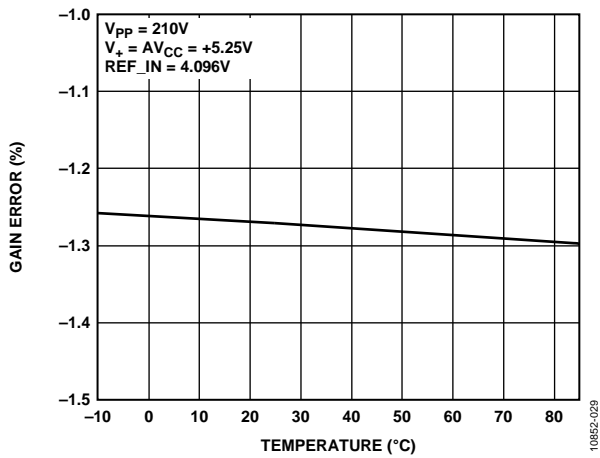

Figure 12. Gain Error vs. Temperature

TERMINOLOGY

Integral Nonlinearity (INL)

A measure of the maximum deviation from a straight line passing through the endpoints of the DAC transfer function. It is expressed as a percentage of full-scale range.

Differential Nonlinearity (DNL)

The difference between the measured change and the ideal 1 LSB change between any two adjacent codes. A specified DNL of ± 1 LSB maximum ensures monotonicity.

Zero Code Voltage

A measure of the output voltage present at the device output with all 0s loaded to the DAC. It includes the offset of the DAC and the output amplifier and is expressed in V.

Offset Error

Calculated by taking two points in the linear region of the transfer function, drawing a line through these points, and extrapolating back to the y-axis. It is expressed in V.

Voltage Gain

Calculated from the change in output voltage for a change in code, multiplied by 16,384, and divided by the REF_IN voltage. This is calculated between two points in the linear section of the transfer function.

Gain Error

A measure of the output error with all 1s loaded to the DAC, and the difference between the ideal and actual analog output range. Ideally, the output should be $50 \times \text{REF_IN}$. It is expressed as a percentage of full-scale range.

DC Power Supply Rejection Ratio (PSRR)

A measure of the change in analog output for a change in V_{PP} supply voltage. It is expressed in dB, and V_{PP} is varied $\pm 5\%$.

DC Crosstalk

The dc change in the output level of one DAC at midscale in response to a full-scale code change (all 0s to all 1s and vice versa) and the output change of all other DACs. It is expressed in LSB.

Output Voltage Settling Time

The time taken from when the last data bit is clocked into the DAC until the output has settled to within ± 0.5 LSB of its final value. Measured for a step change of $\frac{1}{4}$ to $\frac{3}{4}$ full scale.

Digital-to-Analog Glitch Impulse

The area of the glitch injected into the analog output when the code in the DAC register changes state. It is specified as the area of the glitch in nV-sec when the digital code is changed by 1 LSB at the major carry transition (011 . . . 11 to 100 . . . 00 or 100 . . . 00 to 011 . . . 11).

Analog Crosstalk

The area of the glitch transferred to the output (V_{OUT}) of one DAC due to a full-scale change in the output (V_{OUT}) of another DAC. The area of the glitch is expressed in nV-sec.

Digital Feedthrough

A measure of the impulse injected into the analog outputs from the digital control inputs when the part is not being written to (SYNC is high). It is specified in nV-sec and measured with a worst-case change on the digital input pins, for example, from all 0s to all 1s and vice versa.

Output Noise Spectral Density

A measure of internally generated random noise. Random noise is characterized as a spectral density (voltage per $\sqrt{\text{Hz}}$). It is measured by loading all DACs to midscale and measuring noise at the output. It is measured in $\mu\text{V}/\sqrt{\text{Hz}}$.

FUNCTIONAL DESCRIPTION

The **AD5535B** consists of a 32-channel, 14-bit DAC with 200 V high voltage amplifiers in a single 15 mm × 15 mm CSP_BGA package. The output voltage range is programmable via the REF_IN pin. The output range is 0 V to 50 V when REF_IN = 1 V, and 0 V to 200 V when REF_IN = 4 V. Communication to the device is through a serial interface operating at clock rates of up to 30 MHz, which is compatible with DSP and microcontroller interface standards. A 5-bit address and a 14-bit data-word are loaded into the **AD5535B** input register via the serial interface. The channel address is decoded, and the data-word is converted into an analog output voltage for this channel.

At power-on, all the DAC registers are loaded with 0s.

DAC SECTION

The architecture of each DAC channel consists of a resistor string DAC, followed by an output buffer amplifier operating with a nominal gain of 50. The voltage at the REF_IN pin provides the reference voltage for the corresponding DAC. The input coding to the DAC is straight binary, and the ideal DAC output voltage is given by

$$V_{OUT} = \frac{50 \times V_{REF_IN} \times D}{2^{14}}$$

where D is the decimal equivalent (0 to 16,383) of the binary code, which is loaded to the DAC register.

The output buffer amplifier is specified to drive a load of 1 M Ω and 200 pF. The linear output voltage range for the output amplifier is from 7 V to $V_{PP} - 1$ V. The amplifier output bandwidth is typically 30 kHz, and is capable of sourcing 550 μ A and sinking 2.8 mA. Settling time for a $\frac{1}{4}$ to $\frac{3}{4}$ full-scale step change is typically 60 μ s with a load of up to 200 pF.

RESET FUNCTION

The reset function on the **AD5535B** can be used to reset all nodes on the device to their power-on reset condition. All the DACs are loaded with 0s, and all registers are cleared. Take the RESET pin low to implement the reset function.

SERIAL INTERFACE

The serial interface is controlled by the three following pins:

- SYNC, which is the frame synchronization pin for the serial interface.
- SCLK, which is the serial clock input that operates at clock speeds of up to 30 MHz.
- DIN, which is the serial data input and data must be valid upon the falling edge of SCLK.

To update a single DAC channel, a 19-bit data-word is written to the **AD5535B** input register.

A4 to A0 Bits

The A4 to A0 bits can address any one of the 32 channels. A4 is the MSB of the address, while A0 is the LSB.

DB13 to DB0 Bits

The DB13 to DB0 bits are used to write a 14-bit data-word into the addressed DAC register.

Figure 2 is the timing diagram for a serial write to the **AD5535B**. The serial interface works with both a continuous and a discontinuous serial clock. The first falling edge of SYNC resets the serial clock counter to ensure that the correct number of bits are shifted into the serial shift register. Any further edges on SYNC are ignored until the correct number of bits are shifted in. After 19 bits are shifted in, the SCLK is ignored. For another serial transfer to take place, the counter must be reset by the falling edge of SYNC. The user must allow 200 ns (minimum) between successive writes.

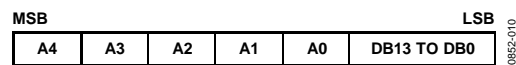

Figure 15. Serial Data Format

MICROPROCESSOR INTERFACING

AD5535B-to-ADSP-BF527 Interface

The Blackfin® DSP is easily interfaced to the **AD5535B** without the need for extra logic. A data transfer is initiated by writing a word to the TX register after SPORT is enabled. In a write sequence, data is clocked out on each rising edge of the serial clock of the DSP and clocked into the **AD5535B** on the falling edge of its SCLK. The SPORT can be configured to transmit 19 SCLKs while TFS is low. Figure 16 shows the connection diagram.

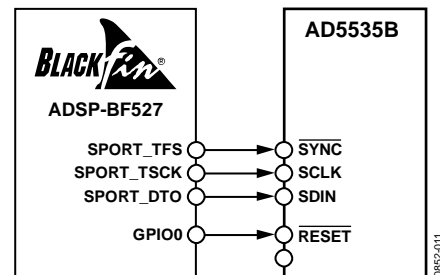
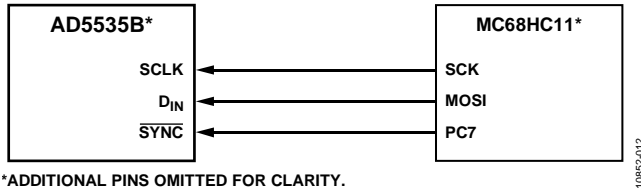

Figure 16. AD5535B-to-ADSP-BF527 Interface

AD5535B-to-MC68HC11 Interface

The serial peripheral interface (SPI) on the MC68HC11 is configured for master mode (MSTR = 1), clock polarity bit (CPOL) = 0, and clock phase bit (CPHA) = 1. The SPI is configured by writing to the SPI control register (SPCR). SCK of the MC68HC11 drives the SCLK of the AD5535B and the MOSI output drives the serial data line (D_{IN}) of the AD5535B. The SYNC signal is derived from a port line (PC7). When data is being transmitted to the AD5535B, the SYNC pin is taken low (PC7).

Data appearing on the MOSI output is valid on the falling edge of SCK. The MC68HC11 transfers only eight bits of data during each serial transfer operation; therefore, three consecutive write operations are necessary to transmit 19 bits of data. Data is transmitted MSB first. It is important to left justify the data in the SPDR register so that the first 19 bits transmitted contain valid data. PC7 must be pulled low to start a transfer. PC7 is then taken high and pulled low again before any further write cycles can take place. Figure 17 shows the connection diagram.



*ADDITIONAL PINS OMITTED FOR CLARITY.

Figure 17. AD5535B-to-MC68HC11 Interface

AD5535B-to-PIC16C6x/7x Interface

The PIC16C6x/7x synchronous serial port (SSP) is configured as an SPI master with the clock polarity bit = 0. This is done by writing to the synchronous serial port control register (SSPCON). In this example, I/O port RA1 is being used to pulse SYNC and to enable the serial port of the AD5535B. This microcontroller transfers only eight bits of data during each serial transfer operation; therefore, three consecutive write operations are

necessary to transmit 19 bits of data. Data is transmitted MSB first. It is important to left justify the data in the SPDR register so that the first 19 bits transmitted contain valid data. RA1 must be pulled low to start a transfer. RA1 must then be brought high and pulled low again before any further write cycles can take place. Figure 18 shows the connection diagram.

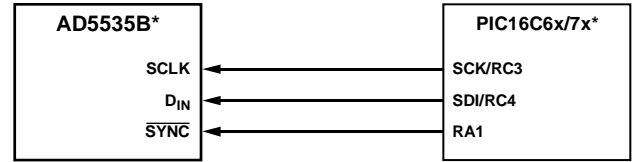

*ADDITIONAL PINS OMITTED FOR CLARITY.

Figure 18. AD5535B-to-PIC16C6x/7x Interface

AD5535B-to-8051 Interface

The AD5535B requires a clock synchronized to the serial data. Therefore, the 8051 serial interface must operate in Mode 0. In this mode, serial data exits the 8051 through RxD, and a shift clock is output on TxD. The SYNC signal is derived from a port line (P1.1). Figure 19 shows how the 8051 is connected to the AD5535B. Because the AD5535B shifts data out upon the rising edge of the shift clock and latches data in upon the falling edge, the shift clock must be inverted. Note that the AD5535B also requires its data to be MSB first. Because the 8051 outputs LSB first, the transmit routine must take this into account.

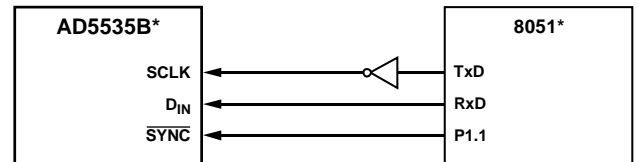

*ADDITIONAL PINS OMITTED FOR CLARITY.

Figure 19. AD5535B-to-8051 Interface

APPLICATIONS INFORMATION

MEMS MIRROR CONTROL APPLICATION

The **AD5535B** is targeted to all optical switching control systems based on MEMS technology. The **AD5535B** is a 32-channel, 14-bit DAC with integrated high voltage amplifiers. The output amplifiers are capable of generating an output range of 0 V to 200 V when using a 4 V reference. The full-scale output voltage is programmable from 50 V to 200 V using reference voltages from 1 V to 4 V. Each amplifier can output 550 μ A and directly drives the control actuators, which determine the position of MEMS mirrors in optical switch applications.

The **AD5535B** is generally used in a closed-loop feedback system, as shown in Figure 20, with a high resolution ADC and DSP. The exact position of each mirror is measured using capacitive sensors. The sensor outputs are multiplexed using an **ADG739** 4-to-1 multiplexer to an 8-channel, 14-bit ADC (**AD7856**). An alternative solution is to multiplex using a 32-to-1 multiplexer (**ADG732**) into a single-channel ADC (**AD7671**). The control loop is driven by an **ADSP-21065L**, a 32-bit SHARC[®] DSP with an SPI-compatible SPORT interface. With 14-bit monotonic behavior and a 0 V to 200 V output range, coupled with its fast serial interface, the **AD5535B** is ideally suited for controlling a cluster of MEMS-based mirrors.

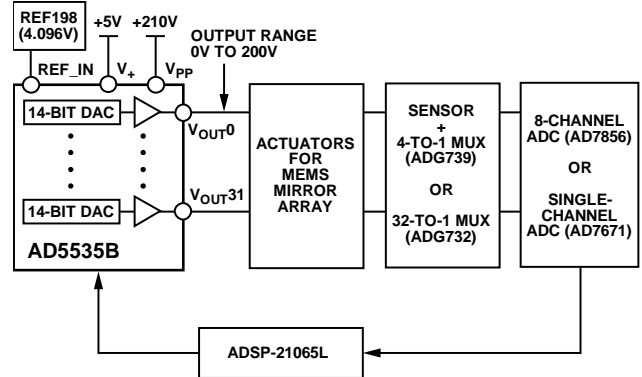

Figure 20. **AD5535B** in a MEMS-Based Optical Switch

IPC-221-COMPLIANT BOARD LAYOUT

The diagram in Figure 21 is a typical 2-layer printed circuit board (PCB) layout for the **AD5535B** that complies with the specifications outlined in IPC-221. Do not connect to the four corner balls labeled as original no connects. Connect balls labeled as additional no connects to AGND.

The routing shown in Figure 21 shows the feasibility of connecting to the high voltage balls while complying with the spacing requirements of IPC-221. Figure 21 also shows the physical distances that are available.

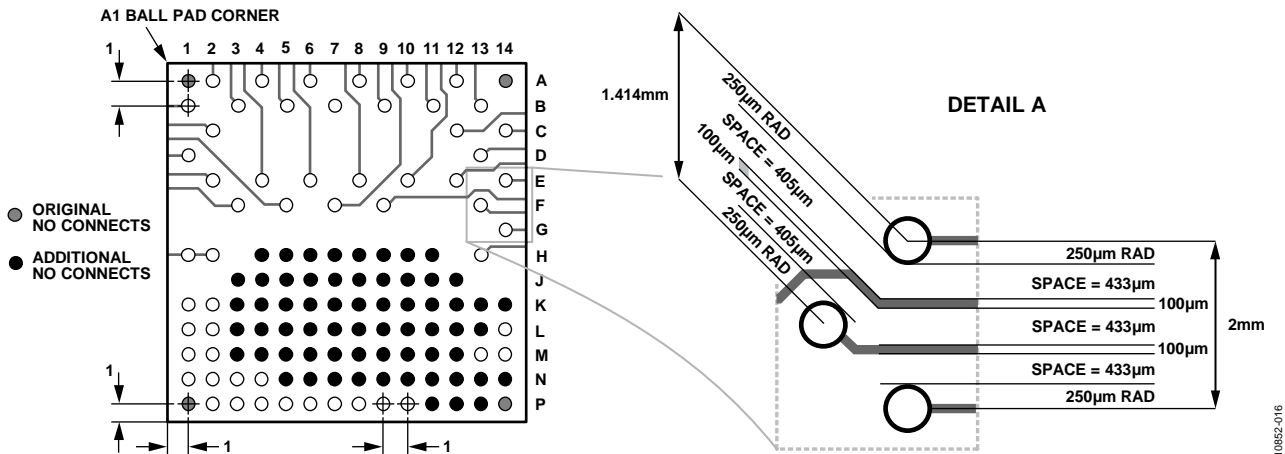

Figure 21. Layout Guidelines to Comply with IPC-221

POWER SUPPLY DECOUPLING RECOMMENDATIONS

On the AD5535B, it is recommended to tie all grounds together as close to the device as possible. If the number of supplies must be reduced, bring all supplies back separately and make a provision on the board via a link option to drive the AV_{CC} and V_+ pins from the same supply. Decouple all power supplies adequately with 10 μF tantalum capacitors and 0.1 μF ceramic capacitors.

GUIDELINES FOR PCB LAYOUT

Design printed circuit boards such that the analog and digital sections are separated and confined to the designated analog and digital sections of the board. This facilitates the use of ground planes that can be separated easily. A minimum etch technique is generally the best for ground planes because it optimizes shielding of sensitive signal lines. Join digital and analog ground planes in one place only, at the AGND and DGND pins of the high resolution converter. To isolate the high frequency bus of the processor from the bus of the high resolution converters, buffer or latch data and address buses on the board. These act as a Faraday shield and increase the signal-to-noise performance of the converters by reducing the amount of high frequency digital coupling. Avoid running digital lines under the device because they couple noise onto the die. Allow the ground plane to run under the IC to avoid noise coupling.

Use as large a trace as possible for the supply lines of the device to provide low impedance paths and reduce the effects of glitches on the power supply line. Shield components, such as clocks with fast-switching signals, with digital ground to avoid radiating noise to other sections of the board. Never run clock signals near the analog inputs of the device. Avoid crossovers of digital and analog signals. Keep traces for analog inputs as wide and short as possible and shield with analog ground if possible. Run traces on opposite sides of the 2-layer PCB at right angles to each other to reduce the effects of feedthrough through the board.

A microstrip technique is by far the best, but it is not always possible to use with a double-sided board. In this technique, the component side of the board is dedicated to ground planes, and signals are placed on the solder side. Multilayer printed circuit boards with dedicated ground, power, and tracking layers offer the optimum solution in terms of obtaining analog performance, but at increased manufacturing costs.

Good decoupling is vitally important when using high resolution converters. Decouple all analog supplies with 10 μF tantalum capacitors in parallel with 0.1 μF ceramic capacitors to analog ground. To achieve the best results from the decoupling components, place them as close to the device as possible, ideally right up against the IC or the IC socket. The main aim of a bypassing element is to maximize the charge stored in the bypass loop while simultaneously minimizing the inductance of this loop. Inductance in the loop acts as an impedance to high frequency transients and results in power supply spiking. By keeping the decoupling as close to the device as possible, the loop area is kept as small as possible, thereby reducing the possibility of power supply spikes. Decouple digital supplies of high resolution converters with 10 μF tantalum capacitors and 0.1 μF ceramic capacitors to the digital ground plane. Decouple the V_+ supply with a 10 μF tantalum capacitor and a 0.1 μF ceramic capacitor to AGND.

Decouple all logic chips with 0.1 μF ceramic capacitors to digital ground to decouple high frequency effects associated with digital circuitry.

OUTLINE DIMENSIONS

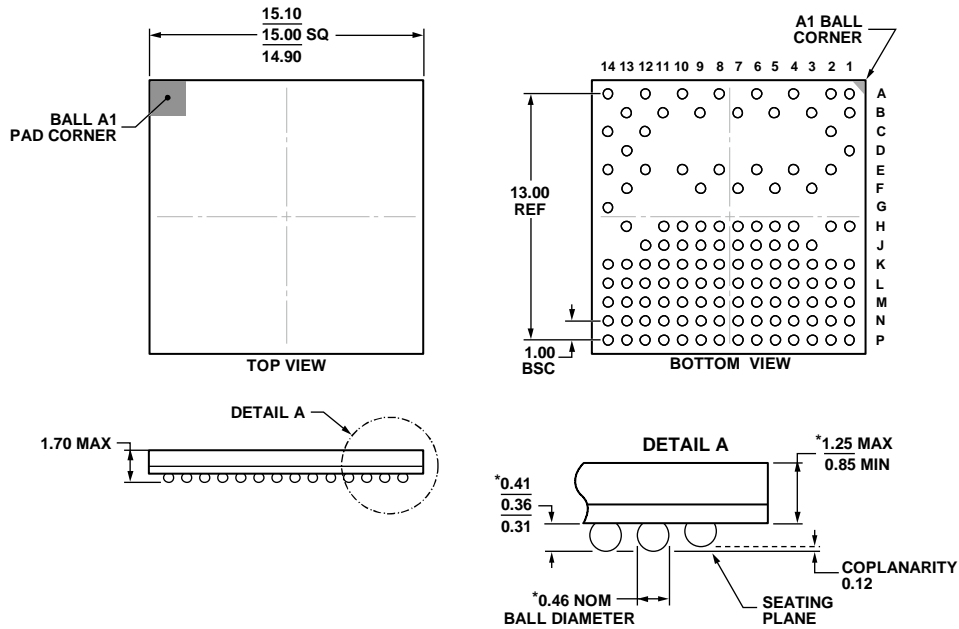

*COMPLIANT WITH JEDEC STANDARDS MO-192-AAE-1 WITH EXCEPTION TO DIMENSIONS INDICATED BY AN ASTERISK. NOMINAL BALL SIZE IS REDUCED FROM 0.60mm TO 0.46mm.

Figure 22. 124-Lead Chip Scale Package Ball Grid Array [CSP_BGA] (BC-124-2)

Dimensions shown in millimeters

12-19-2012-A

ORDERING GUIDE

Model ¹	Function	Output Voltage Span	Temperature Range	Package Description	Package Option
AD5535BKBC	32 DACs	0 V to 200 V maximum	-10°C to +85°C	124-Lead CSP_BGA	BC-124-2
AD5535BKBCZ	32 DACs	0 V to 200 V maximum	-10°C to +85°C	124-Lead CSP_BGA	BC-124-2
EVAL-AD5535BEBZ				Evaluation Board	

¹ Z = RoHS Compliant Part.