

FEATURES

With no external resistors

Difference amplifier: gains of 0.5, 1, or 2

Single ended amplifiers: over 40 different gains

Set reference voltage at midsupply

Excellent ac specifications

15 MHz bandwidth

30 V/ μ s slew rate

High accuracy dc performance

0.08% maximum gain error

10 ppm/ $^{\circ}$ C maximum gain drift

80 dB minimum CMRR (G = 2)

Two channels in small 4 mm \times 4 mm LFCSP

Supply current: 2.5 mA per channel

Supply range: \pm 2.5 V to \pm 18 V

APPLICATIONS

Instrumentation amplifier building blocks

Level translators

Automatic test equipment

High performance audio

Sine/Cosine encoders

GENERAL DESCRIPTION

The AD8270 is a low distortion, dual-channel amplifier with internal gain setting resistors. With no external components, it can be configured as a high performance difference amplifier with gains of 0.5, 1, or 2. It can also be configured in over 40 single-ended configurations, with gains ranging from -2 to $+3$.

The AD8270 is the first dual-difference amplifier in the small 4 mm \times 4 mm LFCSP. It requires the same board area as a typical single-difference amplifier. The smaller package allows a 2 \times increase in channel density and a lower cost per channel, all with no compromise in performance.

The AD8270 operates on both single and dual supplies and requires only 2.5 mA maximum supply current for each amplifier. It is specified over the industrial temperature range of -40° C to $+85^{\circ}$ C and is fully RoHS compliant.

FUNCTIONAL BLOCK DIAGRAM

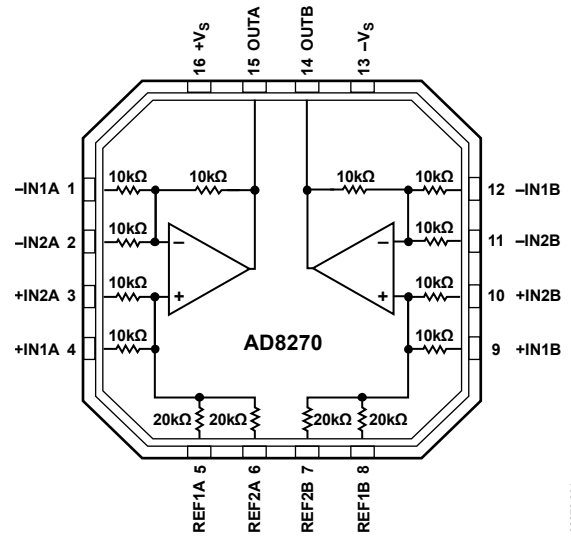

Figure 1.

06879A-001

Table 1. Difference Amplifiers by Category

High Speed	High Voltage	Single-Supply Unidirectional	Single-Supply Bidirectional
AD8270	AD628	AD8202	AD8205
AD8273	AD629	AD8203	AD8206
AMP03			AD8216

Rev. 0

Information furnished by Analog Devices is believed to be accurate and reliable. However, no responsibility is assumed by Analog Devices for its use, nor for any infringements of patents or other rights of third parties that may result from its use. Specifications subject to change without notice. No license is granted by implication or otherwise under any patent or patent rights of Analog Devices. Trademarks and registered trademarks are the property of their respective owners.

TABLE OF CONTENTS

Features	1	Circuit Information.....	13
Applications.....	1	Driving the AD8270.....	13
General Description	1	Package Considerations.....	13
Functional Block Diagram	1	Power Supplies.....	13
Revision History	2	Input Voltage Range.....	14
Specifications.....	3	Applications Information	15
Difference Amplifier Configurations	3	Difference Amplifier Configurations	15
Absolute Maximum Ratings.....	5	Single-Ended Configurations	15
Thermal Resistance	5	Differential Output	17
Maximum Power Dissipation	5	Driving an ADC	18
ESD Caution.....	5	Driving Cabling	18
Pin Configuration and Function Descriptions.....	6	Outline Dimensions	19
Typical Performance Characteristics	7	Ordering Guide	19
Theory of Operation	13		

REVISION HISTORY

1/08—Revision 0: Initial Version

SPECIFICATIONS

DIFFERENCE AMPLIFIER CONFIGURATIONS

$V_S = \pm 15\text{ V}$, $V_{REF} = 0\text{ V}$, $T_A = 25^\circ\text{C}$, $R_{LOAD} = 2\text{ k}\Omega$, specifications referred to input, unless otherwise noted.

Table 2.

Parameter	Conditions	G = 0.5			G = 1			G = 2			Unit
		Min	Typ	Max	Min	Typ	Max	Min	Typ	Max	
DYNAMIC PERFORMANCE											
Bandwidth			20		15		10			MHz	
Slew Rate			30		30		30			V/ μs	
Settling Time to 0.01%	10 V step on output		700	800	700	800	700	800		ns	
Settling Time to 0.001%	10 V step on output		750	900	750	900	750	900		ns	
NOISE/DISTORTION											
Harmonic Distortion	$f = 1\text{ kHz}$, $V_{OUT} = 10\text{ V p-p}$, $R_{LOAD} = 600\ \Omega$		84		145		95			dB	
Voltage Noise ¹	$f = 0.1\text{ Hz to }10\text{ Hz}$		2		1.5		1			$\mu\text{V p-p}$	
	$f = 1\text{ kHz}$		52		38		26			nV/ $\sqrt{\text{Hz}}$	
GAIN											
Gain Error				0.08		0.08		0.08		%	
Gain Drift	$T_A = -40^\circ\text{C to }+85^\circ\text{C}$		1	10	1	10	1	10		ppm/ $^\circ\text{C}$	
INPUT CHARACTERISTICS											
Offset ²			450	1500	300	1000	225	750		μV	
Average Temperature Drift	$T_A = -40^\circ\text{C to }+85^\circ\text{C}$		3		2		1.5			$\mu\text{V}/^\circ\text{C}$	
Common-Mode Rejection Ratio	DC to 1 kHz	70	86		76	92		80	98	dB	
Power Supply Rejection Ratio			2	10	2	10		2	10	$\mu\text{V}/\text{V}$	
Input Voltage Range ³		-15.4		+15.4	-15.4		+15.4	-15.4		+15.4	V
Common-Mode Resistance ⁴			7.5		10		7.5			k Ω	
Bias Current				500		500			500	nA	
OUTPUT CHARACTERISTICS											
Output Swing	$T_A = -40^\circ\text{C to }+85^\circ\text{C}$		-13.8	+13.8	-13.8	+13.8	-13.8	+13.8			V
			-13.7	+13.7	-13.7	+13.7	-13.7	+13.7			V
Short-Circuit Current Limit	Sourcing			100		100		100			mA
	Sinking			60		60		60			mA
POWER SUPPLY											
Supply Current (per Amplifier)	$T_A = -40^\circ\text{C to }+85^\circ\text{C}$		2.3	2.5	2.3	2.5	2.3	2.5			mA
				3		3		3			mA

¹ Includes amplifier voltage and current noise, as well as noise of internal resistors.

² Includes input bias and offset errors.

³ At voltages beyond the rails, internal ESD diodes begin to turn on. In some configurations, the input voltage range may be limited by the internal op amp (see the Input Voltage Range section for details).

⁴ Internal resistors are trimmed to be ratio matched but have $\pm 20\%$ absolute accuracy. Common-mode resistance was calculated with both inputs in parallel. Common-mode impedance at only one input is $2\times$ the resistance listed.

AD8270

$V_S = \pm 5\text{ V}$, $V_{REF} = 0\text{ V}$, $T_A = 25^\circ\text{C}$, $R_{LOAD} = 2\text{ k}\Omega$, specifications referred to input, unless otherwise noted.

Table 3.

Parameter	Conditions	G = 0.5			G = 1			G = 2			Unit
		Min	Typ	Max	Min	Typ	Max	Min	Typ	Max	
DYNAMIC PERFORMANCE											
Bandwidth			20			15			10		MHz
Slew Rate			30			30			30		V/ μs
Settling Time to 0.01%	5 V step on output		550	650		550	650		550	650	ns
Settling Time to 0.001%	5 V step on output		600	750		600	750		600	750	ns
NOISE/DISTORTION											
Harmonic Distortion	$f = 1\text{ kHz}$, $V_{OUT} = 5\text{ V p-p}$, $R_{LOAD} = 600\ \Omega$		101			141			112		dB
Voltage Noise ¹	$f = 0.1\text{ Hz to }10\text{ Hz}$ $f = 1\text{ kHz}$		2			1.5			1		$\mu\text{V p-p}$ nV/ $\sqrt{\text{Hz}}$
GAIN											
Gain Error				0.08			0.08			0.08	%
Gain Drift	$T_A = -40^\circ\text{C to }+85^\circ\text{C}$		1	10		1	10		1	10	ppm/ $^\circ\text{C}$
INPUT CHARACTERISTICS											
Offset ²			450	1500		300	1000		225	750	μV
Average Temperature Drift	$T_A = -40^\circ\text{C to }+85^\circ\text{C}$		3			2			1.5		$\mu\text{V}/^\circ\text{C}$
Common-Mode Rejection Ratio	DC to 1 kHz	70	86		76	92		80	98		dB
Power Supply Rejection Ratio			2	10		2	10		2	10	dB
Input Voltage Range ³		-5.4		+5.4	-5.4		+5.4	-5.4		+5.4	V
Common-Mode Resistance ⁴			7.5			10			7.5		k Ω
Bias Current				500			500			500	nA
OUTPUT CHARACTERISTICS											
Output Swing		-4		+4	-4		+4	-4		+4	V
	$T_A = -40^\circ\text{C to }+85^\circ\text{C}$	-3.9		+3.9	-3.9		+3.9	-3.9		+3.9	V
Short-Circuit Current Limit	Sourcing		100			100			100		mA
	Sinking		60			60			60		mA
POWER SUPPLY											
Supply Current (per Amplifier)			2.3	2.5		2.3	2.5		2.3	2.5	mA
	$T_A = -40^\circ\text{C to }+85^\circ\text{C}$			3			3			3	mA

¹ Includes amplifier voltage and current noise, as well as noise of internal resistors.

² Includes input bias and offset errors.

³ At voltages beyond the rails, internal ESD diodes begin to turn on. In some configurations, the input voltage range may be limited by the internal op amp (see the Input Voltage Range section for details).

⁴ Internal resistors are trimmed to be ratio matched but have $\pm 20\%$ absolute accuracy. Common-mode resistance was calculated with both inputs in parallel. Common-mode impedance at only one input is $2\times$ the resistance listed.

ABSOLUTE MAXIMUM RATINGS

Table 4.

Parameter	Rating
Supply Voltage	± 18 V
Output Short-Circuit Current	See derating curve in Figure 2
Input Voltage Range	$\pm V_S$
Storage Temperature Range	-65°C to $+130^\circ\text{C}$
Specified Temperature Range	-40°C to $+85^\circ\text{C}$
Package Glass Transition Temperature (T_G)	130°C
ESD (Human Body Model)	1 kV
ESD (Charge Device Model)	1 kV
ESD (Machine Model)	0.1 kV

Stresses above those listed under Absolute Maximum Ratings may cause permanent damage to the device. This is a stress rating only; functional operation of the device at these or any other conditions above those indicated in the operational section of this specification is not implied. Exposure to absolute maximum rating conditions for extended periods may affect device reliability.

THERMAL RESISTANCE

Table 5. Thermal Resistance

Thermal Pad	θ_{JA}	Unit
16-Lead LFCSP with Thermal Pad Soldered to Board	57	$^\circ\text{C}/\text{W}$
16-Lead LFCSP with Thermal Pad Not Soldered to Board	96	$^\circ\text{C}/\text{W}$

The θ_{JA} values in Table 5 assume a 4-layer JEDEC standard board with zero airflow. If the thermal pad is soldered to the board, it is also assumed it is connected to a plane. θ_{JC} at the exposed pad is $9.7^\circ\text{C}/\text{W}$.

MAXIMUM POWER DISSIPATION

The maximum safe power dissipation for the AD8270 is limited by the associated rise in junction temperature (T_J) on the die. At approximately 130°C , which is the glass transition temperature, the plastic changes its properties. Even temporarily exceeding this temperature limit may change the stresses that the package exerts on the die, permanently shifting the parametric performance of the amplifiers. Exceeding a temperature of 130°C for an extended period of time can result in a loss of functionality.

The AD8270 has built-in, short-circuit protection that limits the output current to approximately 100 mA (see Figure 19 for more information). While the short-circuit condition itself does not damage the part, the heat generated by the condition can cause the part to exceed its maximum junction temperature, with corresponding negative effects on reliability.

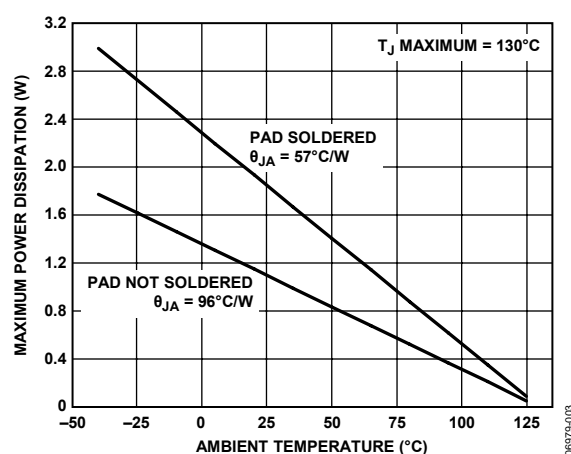

Figure 2. Maximum Power Dissipation vs. Ambient Temperature

ESD CAUTION



ESD (electrostatic discharge) sensitive device. Charged devices and circuit boards can discharge without detection. Although this product features patented or proprietary protection circuitry, damage may occur on devices subjected to high energy ESD. Therefore, proper ESD precautions should be taken to avoid performance degradation or loss of functionality.

PIN CONFIGURATION AND FUNCTION DESCRIPTIONS

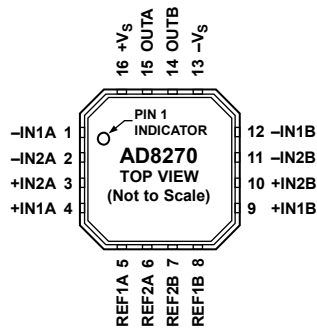

Figure 3. Pin Configuration

Table 6. Pin Function Descriptions

Pin No.	Mnemonic	Description
1	-IN1A	10 k Ω Resistor Connected to Negative Terminal of Op Amp A.
2	-IN2A	10 k Ω Resistor Connected to Negative Terminal of Op Amp A.
3	+IN2A	10 k Ω Resistor Connected to Positive Terminal of Op Amp A.
4	+IN1A	10 k Ω Resistor Connected to Positive Terminal of Op Amp A.
5	REF1A	20 k Ω Resistor Connected to Positive Terminal of Op Amp A. Most configurations use this pin as a reference voltage input.
6	REF2A	20 k Ω Resistor Connected to Positive Terminal of Op Amp A. Most configurations use this pin as a reference voltage input.
7	REF2B	20 k Ω Resistor Connected to Positive Terminal of Op Amp B. Most configurations use this pin as a reference voltage input.
8	REF1B	20 k Ω Resistor Connected to Positive Terminal of Op Amp B. Most configurations use this pin as a reference voltage input.
9	+IN1B	10 k Ω Resistor Connected to Positive Terminal of Op Amp B.
10	+IN2B	10 k Ω Resistor Connected to Positive Terminal of Op Amp B.
11	-IN2B	10 k Ω Resistor Connected to Negative Terminal of Op Amp B.
12	-IN1B	10 k Ω Resistor Connected to Negative Terminal of Op Amp B.
13	-Vs	Negative Supply.
14	OUTB	Op Amp B Output.
15	OUTA	Op Amp A Output.
16	+Vs	Positive Supply.

TYPICAL PERFORMANCE CHARACTERISTICS

$V_S = \pm 15\text{ V}$, $T_A = 25^\circ\text{C}$, difference amplifier configuration, unless otherwise noted.

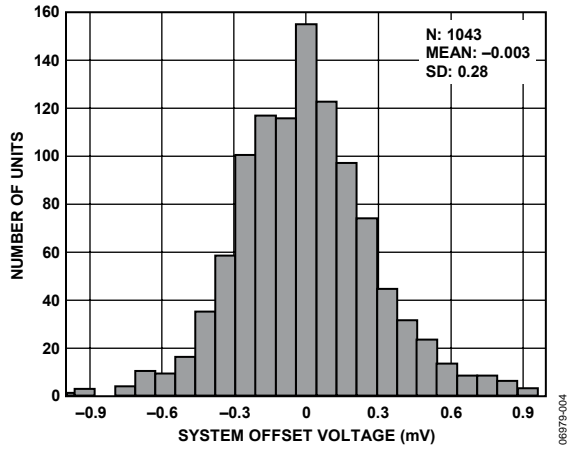

Figure 4. Typical Distribution of System Offset Voltage, $G = 1$

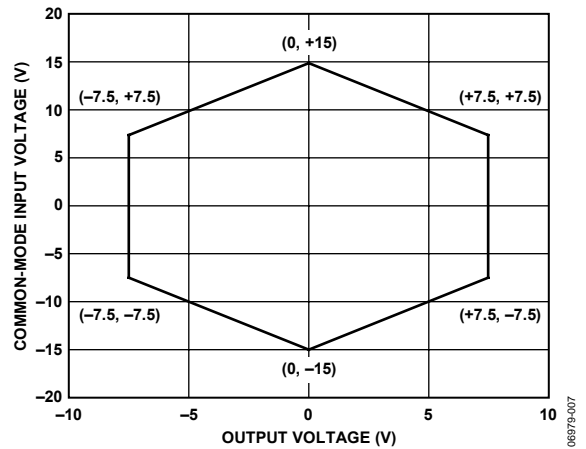

Figure 7. Common-Mode Input Voltage vs. Output Voltage, Gain = 0.5, $\pm 15\text{ V}$ Supplies

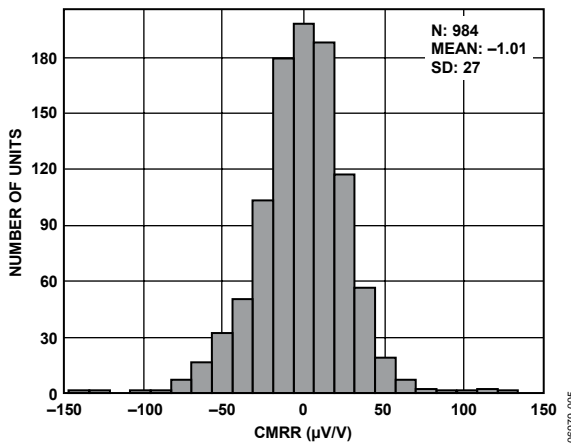

Figure 5. Typical Distribution of CMRR, $G = 1$

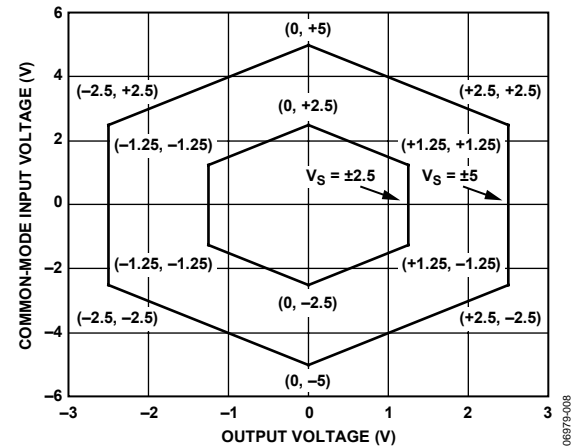

Figure 8. Common-Mode Input Voltage vs. Output Voltage, Gain = 0.5, $\pm 5\text{ V}$ and $\pm 2.5\text{ V}$ Supplies

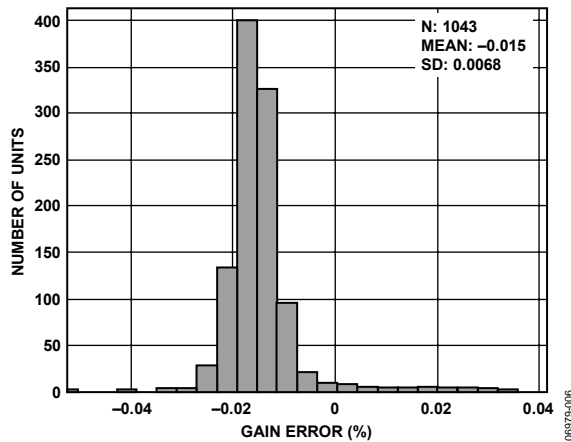

Figure 6. Typical Distribution of Gain Error, $G = 1$

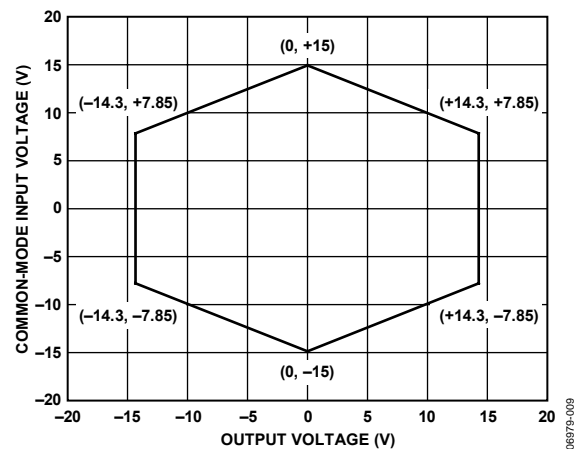

Figure 9. Common-Mode Input Voltage vs. Output Voltage, Gain = 1, $\pm 15\text{ V}$ Supplies

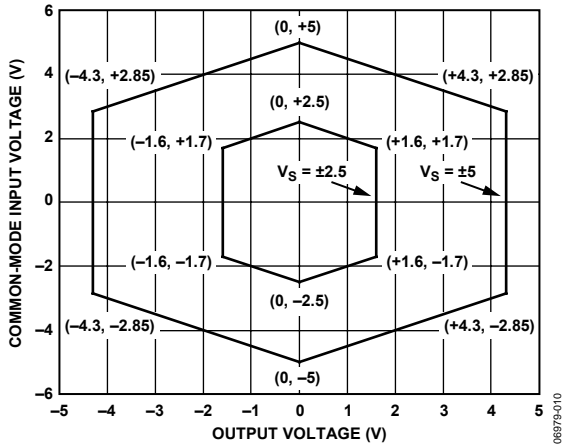

Figure 10. Common-Mode Input Voltage vs. Output Voltage, Gain = 1, ± 5 V and ± 2.5 V Supplies

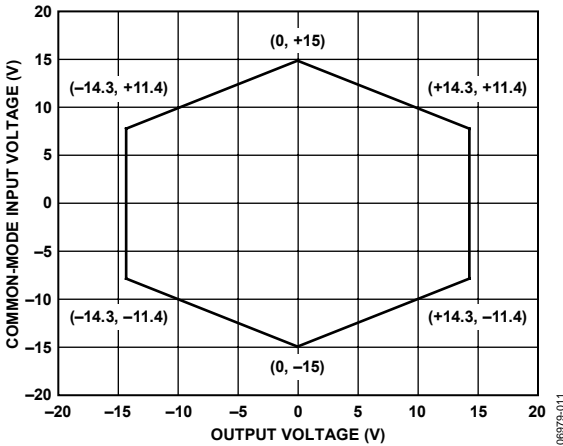

Figure 11. Common-Mode Input Voltage vs. Output Voltage, Gain = 2, ± 15 V Supplies

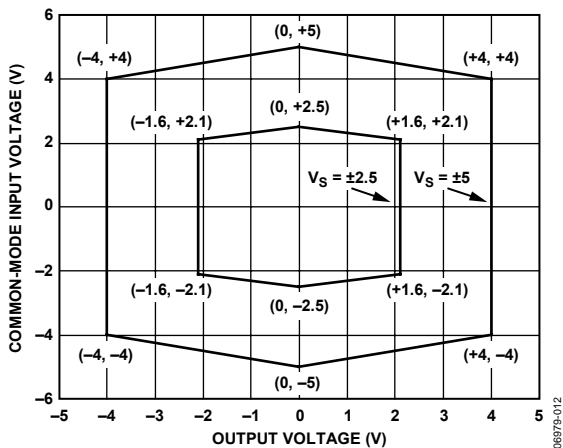

Figure 12. Common-Mode Input Voltage vs. Output Voltage, Gain = 2, ± 5 V and ± 2.5 V Supplies

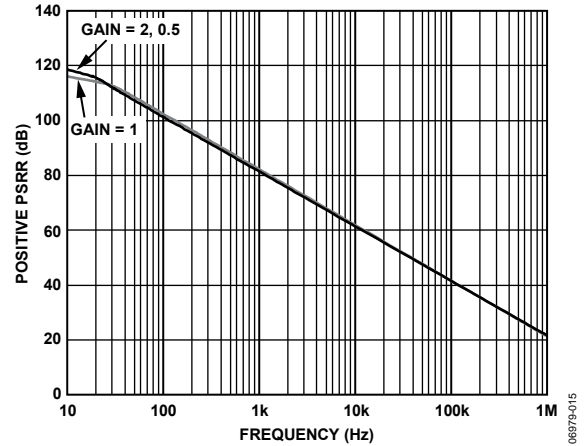

Figure 13. Positive PSRR vs. Frequency

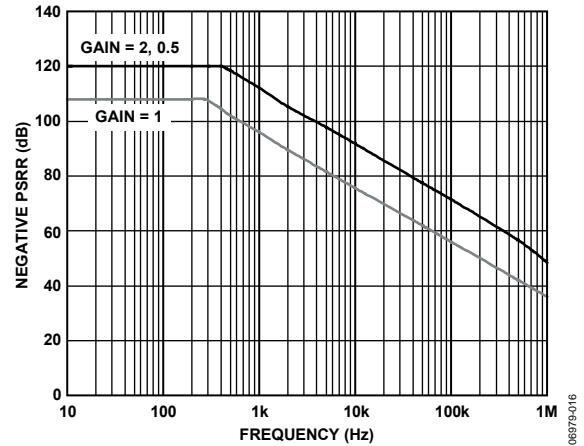

Figure 14. Negative PSRR vs. Frequency

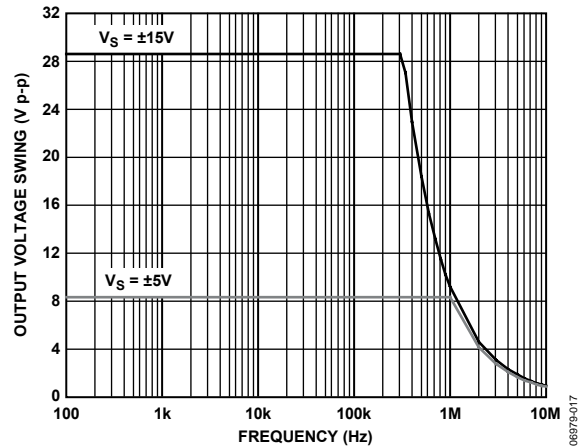

Figure 15. Output Voltage Swing vs. Large Signal Frequency Response

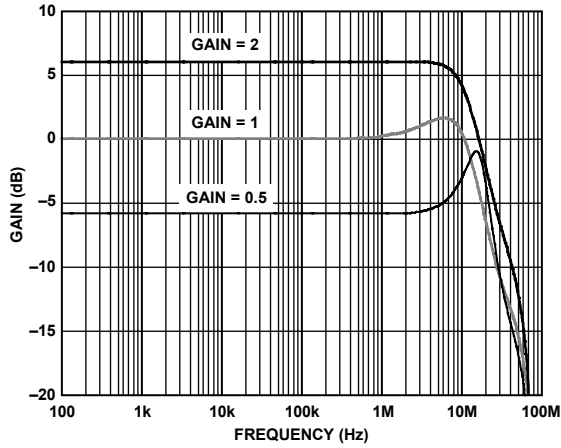

Figure 16. Gain vs. Frequency

06879-018

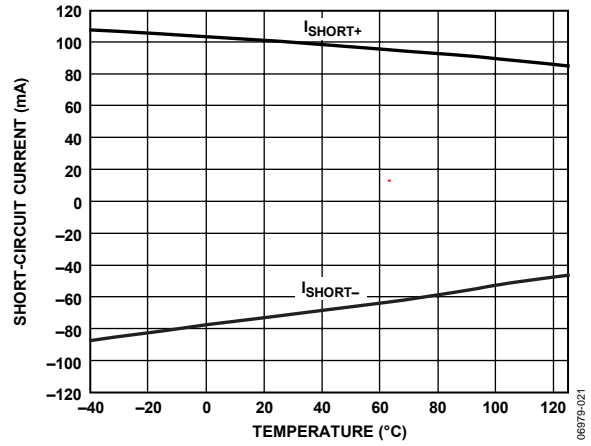

Figure 19. Short-Circuit Current vs. Temperature

06879-021

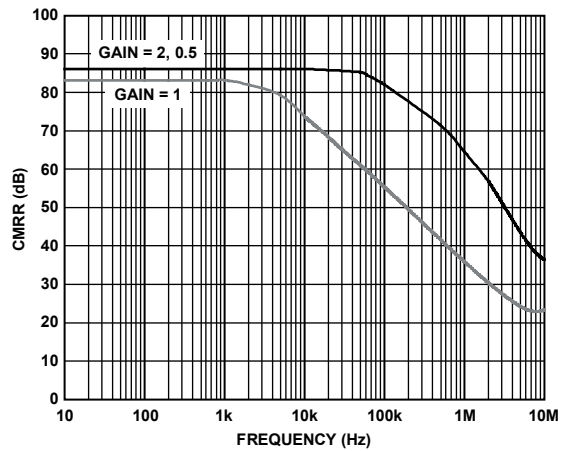

Figure 17. CMRR vs. Frequency

06879-019

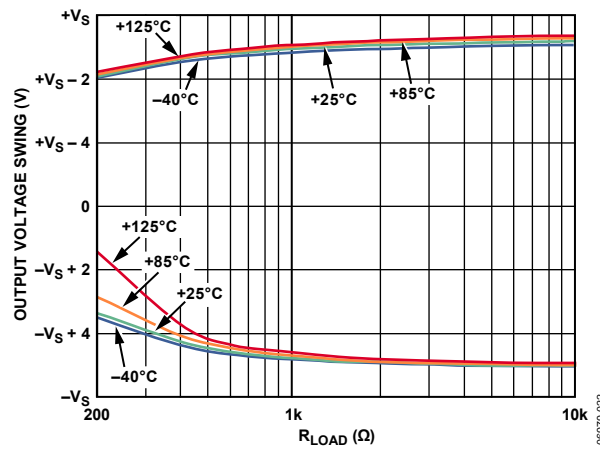

Figure 20. Output Voltage Swing vs. R_{LOAD}

06879-022

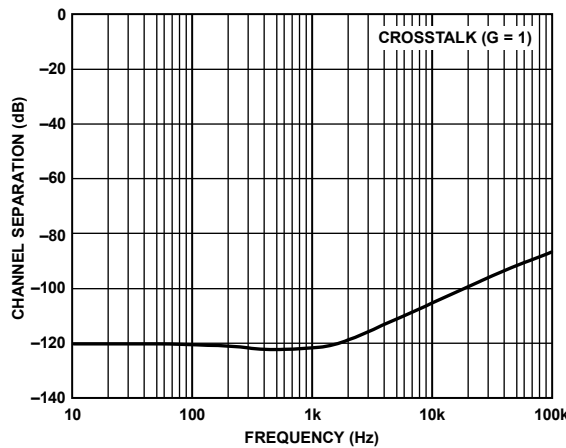

Figure 18. Channel Separation vs. Frequency

06879-013

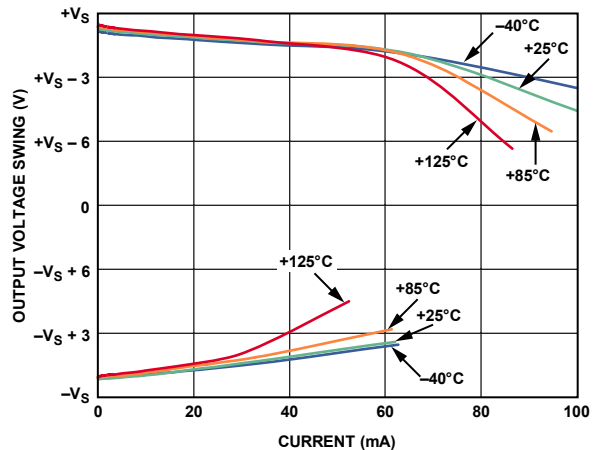

Figure 21. Output Voltage Swing vs. Current (I_{OUT})

06879-023

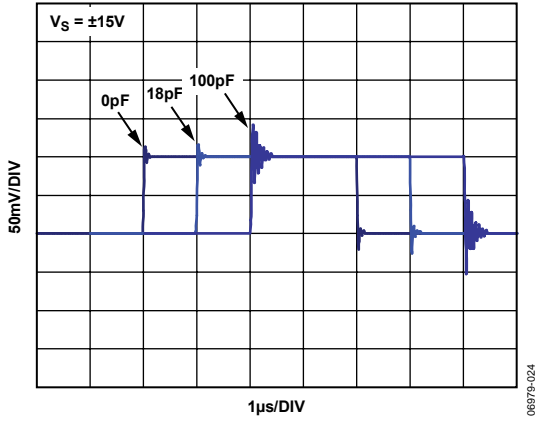

Figure 22. Small Signal Step Response, Gain = 0.5

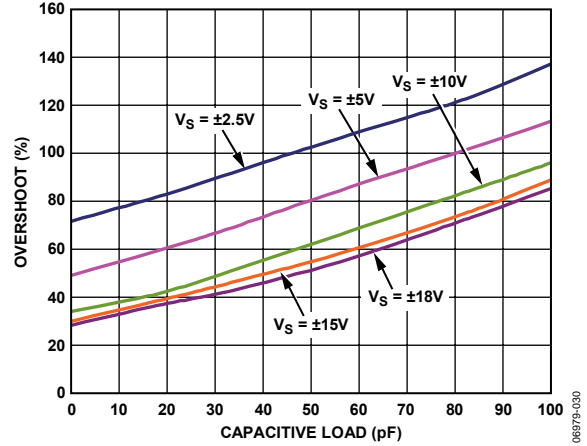

Figure 25. Small Signal Overshoot with Capacitive Load, Gain = 0.5

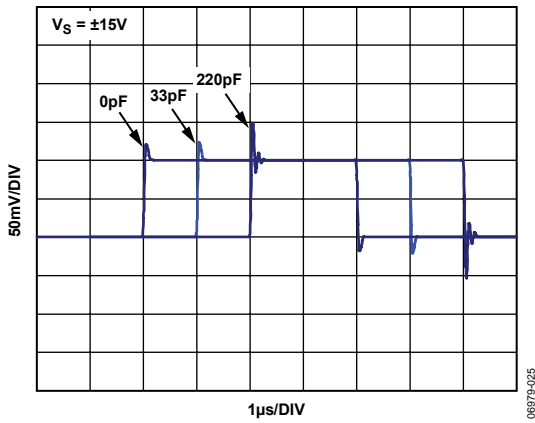

Figure 23. Small Signal Step Response, Gain = 1

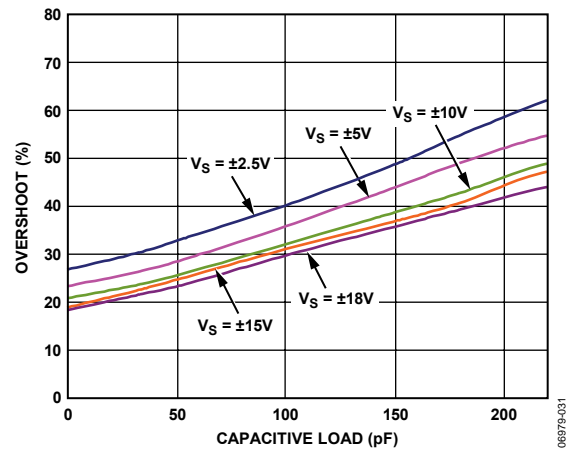

Figure 26. Small Signal Overshoot with Capacitive Load, Gain = 1

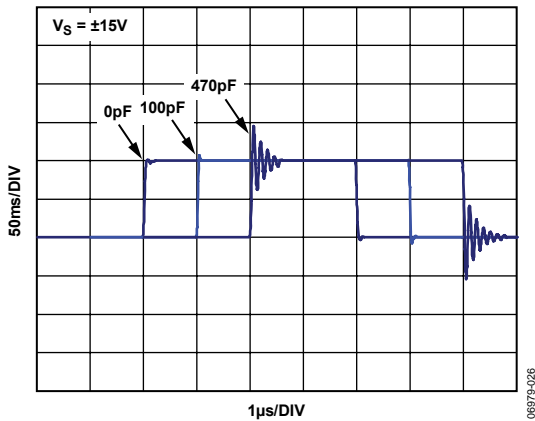

Figure 24. Small Signal Step Response, Gain = 2

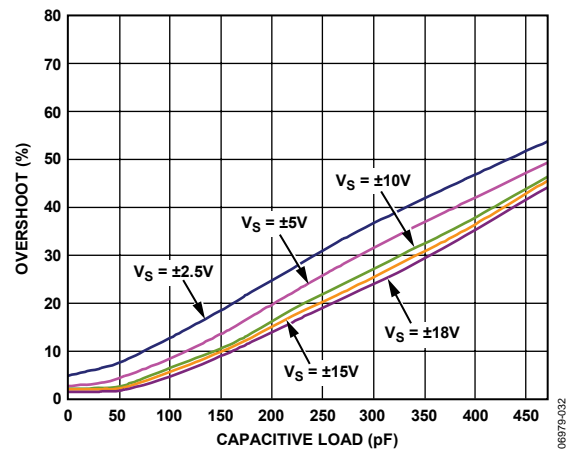

Figure 27. Small Signal Overshoot with Capacitive Load, Gain = 2

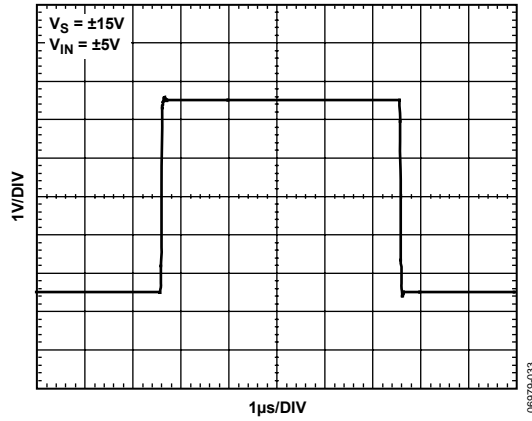

Figure 28. Large Signal Pulse Response Gain = 0.5

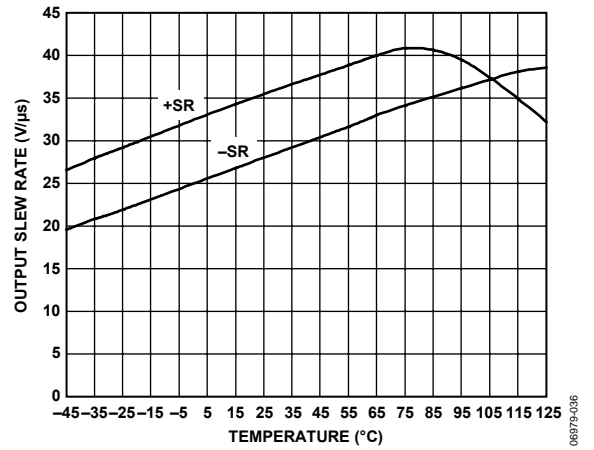

Figure 31. Output Slew Rate vs. Temperature

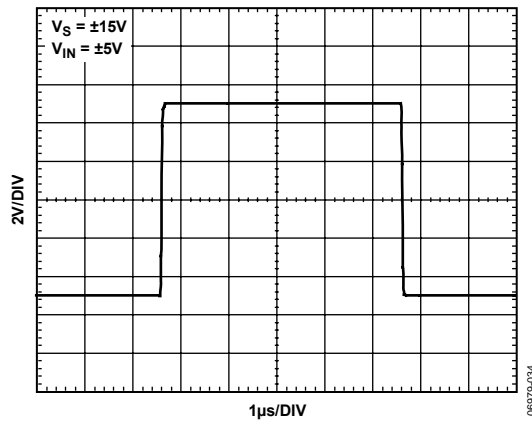

Figure 29. Large Signal Pulse Response Gain = 1

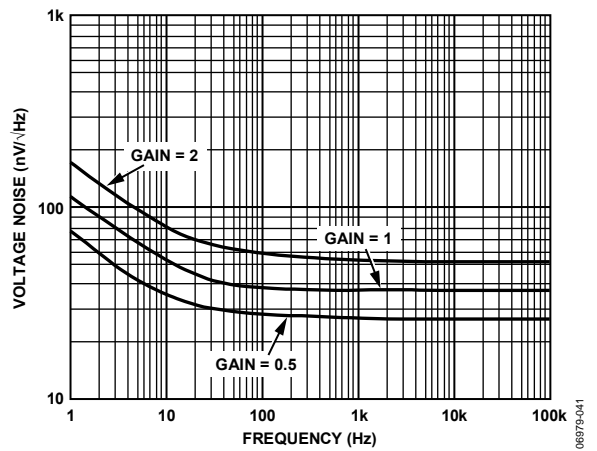

Figure 32. Voltage Noise Spectral Density vs. Frequency, Referred to Output

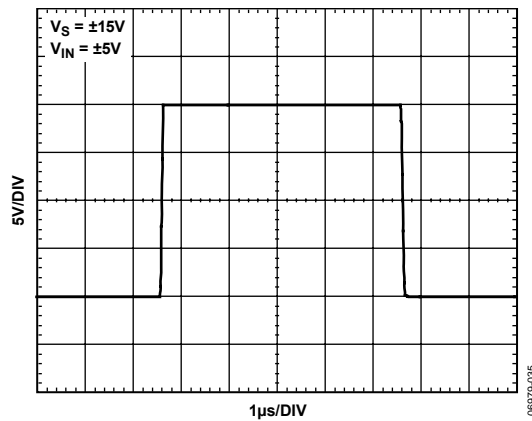

Figure 30. Large Signal Pulse Response, Gain = 2

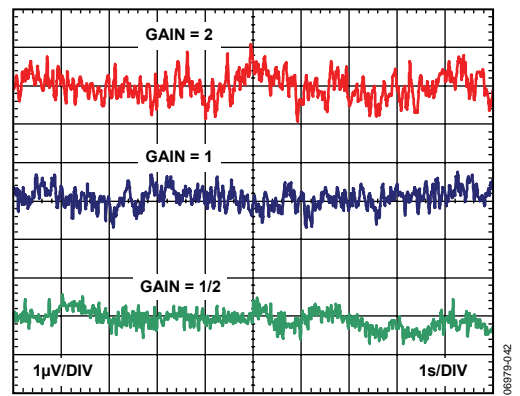

Figure 33. 0.1 Hz to 10 Hz Voltage Noise, Referred to Output

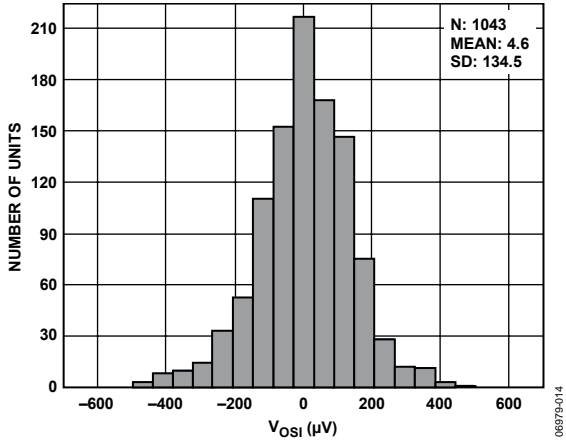

Figure 34. Typical Distribution of Op Amp Voltage Offset

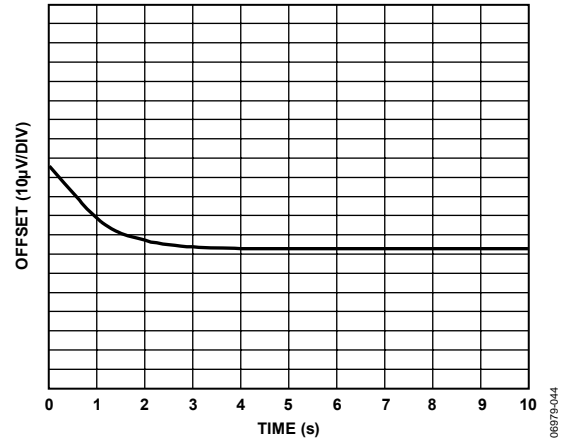

Figure 37. Change in Op Amp Offset Voltage vs. Warm-Up Time

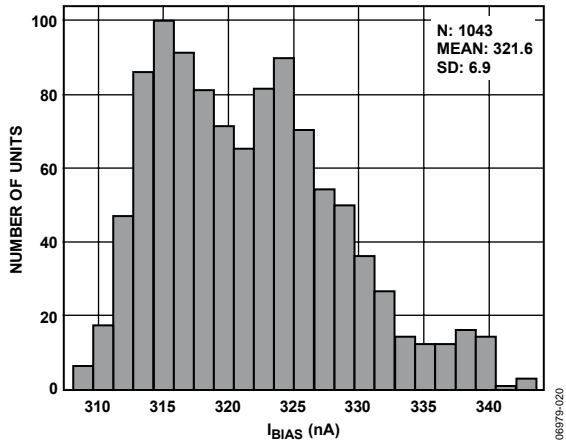

Figure 35. Typical Distribution of Op Amp Bias Current

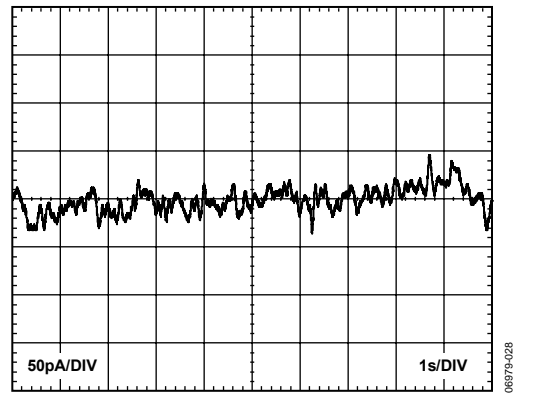

Figure 38. 0.1 Hz to 10 Hz Current Noise of Internal Op Amp

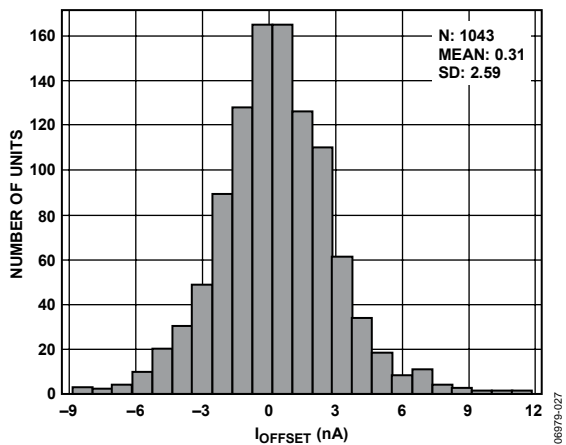

Figure 36. Typical Distribution of Op Amp Offset Current

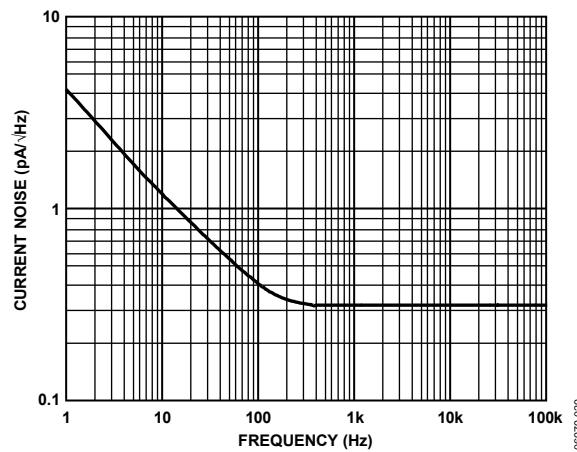

Figure 39. Current Noise Spectral Density of Internal Op Amp

THEORY OF OPERATION

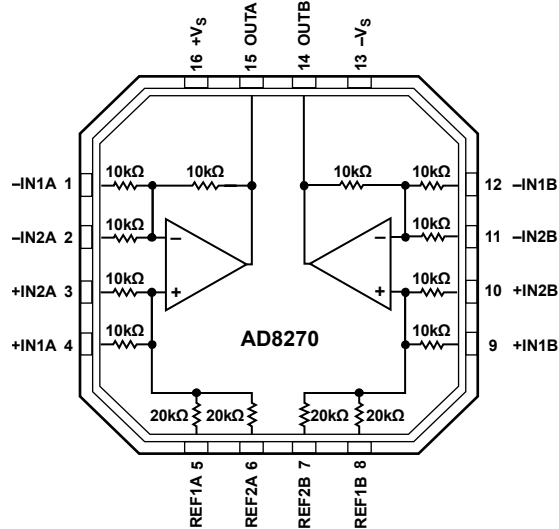

Figure 40. Functional Block Diagram

CIRCUIT INFORMATION

The AD8270 has two channels, each consisting of a high precision, low distortion op amp and seven trimmed resistors. These resistors can be connected to make a wide variety of amplifier configurations: difference, noninverting, inverting, and more. The resistors on the chip can be connected in parallel for a wider range of options. Using the on-chip resistors of the AD8270 provides the designer several advantages over a discrete design.

DC Performance

Much of the dc performance of op amp circuits depends on the accuracy of the surrounding resistors. The resistors on the AD8270 are laid out to be tightly matched. The resistors of each part are laser trimmed and tested for their matching accuracy. Because of this trimming and testing, the AD8270 can guarantee high accuracy for specifications such as gain drift, common-mode rejection, and gain error.

AC Performance

Because feature size is much smaller in an integrated circuit than on a PCB board, the corresponding parasitics are smaller, as well. The smaller feature size helps the ac performance of the AD8270. For example, the positive and negative input terminals of the AD8270 op amp are not pinned out intentionally. By not connecting these nodes to the traces on the PCB board, the capacitance remains low, resulting in both improved loop stability and common-mode rejection over frequency.

Production Costs

Because one part, rather than several, is placed on the PCB board, the board can be built more quickly.

Size

The AD8270 fits two op amps and 14 resistors in a 4 mm × 4 mm package.

DRIVING THE AD8270

The AD8270 is easy to drive, with all configurations presenting at least several kilohms (kΩ) of input resistance. The AD8270 should be driven with a low impedance source: for example, another amplifier. The gain accuracy and common-mode rejection of the AD8270 depend on the matching of its resistors. Even source resistance of a few ohms can have a substantial effect on these specifications.

PACKAGE CONSIDERATIONS

The AD8270 is packaged in a 4 mm × 4 mm LFCSP. Beware of blindly copying the footprint from another 4 mm × 4 mm LFCSP part; it may not have the same thermal pad size and leads. Refer to the Outline Dimensions section to verify that the PCB symbol has the correct dimensions.

The 4 mm × 4 mm LFCSP of the AD8270 comes with a thermal pad. This pad is connected internally to $-V_s$. Connecting to this pad is not necessary for electrical performance; the pad can be left unconnected or can be connected to the negative supply rail.

Connecting the pad to the negative supply rail is recommended in high vibration applications or when good heat dissipation is required (for example, with high ambient temperatures or when driving heavy loads). For best heat dissipation performance, the negative supply rail should be a plane in the board. See the Absolute Maximum Ratings section for thermal coefficients with and without the pad soldered.

Space between the leads and thermal pad should be as wide as possible to minimize the risk of contaminants affecting performance. A thorough washing of the board is recommended after the soldering process, especially if high accuracy performance is required at high temperatures.

POWER SUPPLIES

A stable dc voltage should be used to power the AD8270. Noise on the supply pins can adversely affect performance. A bypass capacitor of 0.1 μF should be placed between each supply pin and ground, as close as possible to each supply pin. A tantalum capacitor of 10 μF should also be used between each supply and ground. It can be farther away from the supply pins and, typically, it can be shared by other precision integrated circuits.

The AD8270 is specified at ±15 V and ±5 V, but it can be used with unbalanced supplies, as well. For example, $-V_s = 0$ V, $+V_s = 20$ V. The difference between the two supplies must be kept below 36 V.

AD8270

INPUT VOLTAGE RANGE

The AD8270 has a true rail-to-rail input range for the majority of applications. Because most AD8270 configurations divide down the voltage before they reach the internal op amp, the op amp sees only a fraction of the input voltage. Figure 41 shows an example of how the voltage division works in the difference amplifier configuration.

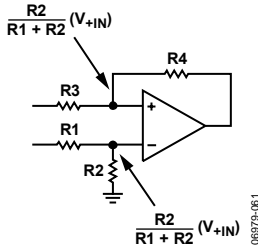

Figure 41. Voltage Division in the Difference Amplifier Configuration

The internal op amp voltage range may be relevant in the following applications, and calculating the voltage at the internal op amp is advised.

- Difference amplifier configurations using supply voltages of less than ± 4.5 V
- Difference amplifier configurations with a reference voltage near the rail
- Single-ended amplifier configurations

For correct operation, the input voltages at the internal op amp must stay within 1.5 V of either supply rail.

Voltages beyond the supply rails should not be applied to the part. The part contains ESD diodes at the input pins, which conduct if voltages beyond the rails are applied. Currents greater than 5 mA can damage these diodes and the part. For a similar part that can operate with voltages beyond the rails, see the [AD8273](#) data sheet.

APPLICATIONS INFORMATION

DIFFERENCE AMPLIFIER CONFIGURATIONS

The AD8270 can be placed in difference amplifier configurations with gains of 0.5, 1, and 2. Figure 42 through Figure 44 show the difference amplifier configurations, referenced to ground. The AD8270 can also be referred to a combination of reference voltages. For example, the reference could be set at 2.5 V, using just 5 V and GND. Some of the possible configurations are shown in Figure 45 through Figure 47.

The layout for Channel A is shown in Figure 42 through Figure 47. The layout for Channel B is symmetrical. Table 7 shows the pin connections for Channel A and Channel B.

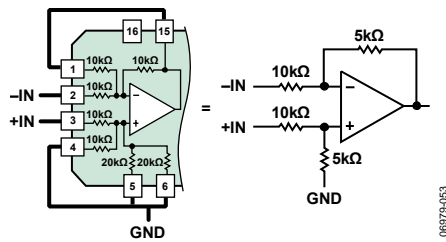

Figure 42. Gain = 0.5 Difference Amplifier, Referenced to Ground

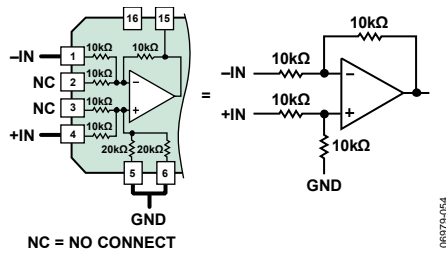

Figure 43. Gain = 1 Difference Amplifier, Referenced to Ground

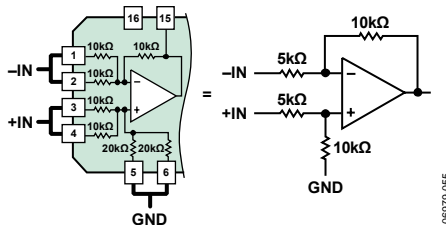

Figure 44. Gain = 2 Difference Amplifier, Referenced to Ground

SINGLE-ENDED CONFIGURATIONS

The AD8270 can be configured for a wide variety of single-ended configurations with gains ranging from -2 to +3. Table 8 shows a subset of the possible configurations.

Many signal gains have more than one configuration choice, which allows freedom in choosing the op amp closed-loop gain. In general, for designs that need to be stable with a large capacitive load on the output, choose a configuration with high loop gain. Otherwise, choose a configuration with low loop gain, because these configurations typically have lower noise, lower offset, and higher bandwidth.

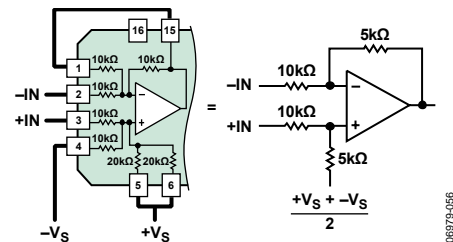

Figure 45. Gain = 0.5 Difference Amplifier, Referenced to Midsupply

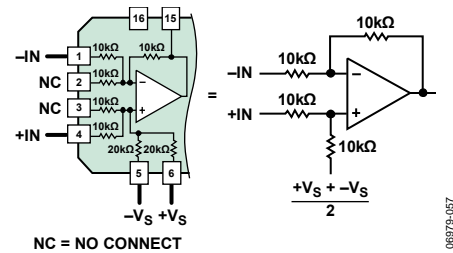

Figure 46. Gain = 1 Difference Amplifier, Referenced to Midsupply

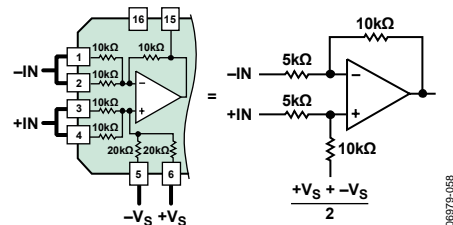

Figure 47. Gain = 2 Difference Amplifier, Referenced to Midsupply

Table 7. Pin Connections for Difference Amplifier Configurations

Gain and Reference	Channel A						Channel B					
	Pin 1	Pin 2	Pin 3	Pin 4	Pin 5	Pin 6	Pin 12	Pin 11	Pin 10	Pin 9	Pin 8	Pin 7
Gain of 0.5, Referenced to Ground	OUT	-IN	+IN	GND	GND	GND	OUT	-IN	+IN	GND	GND	GND
Gain of 0.5, Referenced to Midsupply	OUT	-IN	+IN	-Vs	+Vs	+Vs	OUT	-IN	+IN	-Vs	+Vs	+Vs
Gain of 1, Referenced to Ground	-IN	NC	NC	+IN	GND	GND	-IN	NC	NC	+IN	GND	GND
Gain of 1, Referenced to Midsupply	-IN	NC	NC	+IN	-Vs	+Vs	-IN	NC	NC	+IN	-Vs	+Vs
Gain of 2, Referenced to Ground	-IN	-IN	+IN	+IN	GND	GND	-IN	-IN	+IN	+IN	GND	GND
Gain of 2, Referenced to Midsupply	-IN	-IN	+IN	+IN	-Vs	+Vs	-IN	-IN	+IN	+IN	-Vs	+Vs

Table 8. Selected Single-Ended Configurations

Electrical Performance			Pin Connections					
Signal Gain	Op Amp Closed-Loop Gain	Input Resistance	10 k Ω – Pin 1	10 k Ω – Pin 2	10 k Ω + Pin 3	10 k Ω + Pin 4	20 k Ω + Pin 5	20 k Ω + Pin 6
-2	3	5 k Ω	IN	IN	GND	GND	GND	GND
-1.5	3	4.8 k Ω	IN	IN	GND	GND	GND	IN
-1.4	3	5 k Ω	IN	IN	GND	GND	NC	IN
-1.25	3	5.333 k Ω	IN	IN	GND	NC	GND	IN
-1	3	5 k Ω	IN	IN	GND	GND	IN	IN
-0.8	3	5.556 k Ω	IN	IN	IN	GND	NC	GND
-0.667	2	8 k Ω	IN	NC	GND	GND	GND	IN
-0.6	2	8.333 k Ω	IN	NC	GND	GND	NC	IN
-0.5	2	8.889 k Ω	IN	NC	GND	NC	GND	IN
-0.333	2	7.5 k Ω	IN	NC	GND	GND	IN	IN
-0.25	1.5	8 k Ω	OUT	IN	GND	GND	GND	IN
-0.2	1.5	8.333 k Ω	OUT	IN	GND	GND	NC	IN
-0.125	1.5	8.889 k Ω	OUT	IN	GND	NC	GND	IN
+0.1	1.5	8.333 k Ω	OUT	IN	IN	GND	NC	GND
+0.2	2	10 k Ω	IN	NC	GND	IN	NC	IN
+0.25	1.5	24 k Ω	OUT	GND	GND	GND	GND	IN
+0.3	1.5	25 k Ω	OUT	GND	GND	GND	NC	IN
+0.333	2	24 k Ω	GND	NC	GND	GND	GND	IN
+0.375	1.5	26.67 k Ω	OUT	GND	GND	NC	GND	IN
+0.4	2	25 k Ω	GND	NC	GND	GND	NC	IN
+0.5	3	24 k Ω	GND	GND	GND	GND	GND	IN
+0.5	1.5	15 k Ω	OUT	GND	GND	GND	IN	IN
+0.6	3	25 k Ω	GND	GND	GND	GND	NC	IN
+0.6	1.5	16.67 k Ω	OUT	GND	IN	GND	NC	GND
+0.625	1.5	16 k Ω	OUT	IN	NC	IN	IN	GND
+0.667	2	15 k Ω	GND	NC	GND	GND	IN	IN
+0.7	1.5	16.67 k Ω	OUT	IN	IN	IN	NC	GND
+0.75	3	26.67 k Ω	GND	GND	GND	NC	GND	IN
+0.75	1.5	13.33 k Ω	OUT	GND	GND	IN	GND	IN
+0.8	2	16.67 k Ω	GND	NC	IN	GND	NC	GND
+0.9	1.5	16.67 k Ω	OUT	GND	GND	IN	NC	IN
+1	1.5	15 k Ω	OUT	GND	IN	IN	GND	GND
+1	1.5	>1 G Ω	OUT	IN	IN	IN	IN	IN
+1	3	>1 G Ω	IN	IN	IN	IN	IN	IN
+1.125	1.5	26.67 k Ω	OUT	GND	NC	IN	IN	GND
+1.2	3	16.67 k Ω	GND	GND	IN	GND	NC	GND
+1.2	1.5	25 k Ω	OUT	GND	IN	IN	NC	GND
+1.25	1.5	24 k Ω	OUT	GND	IN	IN	IN	GND
+1.333	2	15 k Ω	GND	NC	IN	IN	GND	GND
+1.5	3	13.33 k Ω	GND	GND	GND	IN	GND	IN
+1.5	1.5	>1 G Ω	OUT	GND	IN	IN	IN	IN
+1.6	2	25 k Ω	GND	NC	IN	IN	NC	GND
+1.667	2	24 k Ω	GND	NC	IN	IN	IN	GND
+1.8	3	16.67 k Ω	GND	GND	GND	IN	NC	IN
+2	2	>1 G Ω	GND	NC	IN	IN	IN	IN
+2.25	3	26.67 k Ω	GND	GND	NC	IN	IN	GND
+2.4	3	25 k Ω	GND	GND	IN	IN	NC	GND
+2.5	3	24 k Ω	GND	GND	IN	IN	IN	GND
+3	3	>1 G Ω	GND	GND	IN	IN	IN	IN

The AD8270 Specifications section and Typical Performance Characteristics section show the performance of the part primarily when it is in the difference amplifier configuration. To get a good estimate of the performance of the part in a single-ended configuration, refer to the difference amplifier configuration with the corresponding closed-loop gain (see Table 9).

Table 9. Closed-Loop Gain of the Difference Amplifiers

Difference Amplifier Gain	Closed-Loop Gain
0.5	1.5
1	2
2	3

Gain of 1 Configuration

The AD8270 is designed to be stable for loop gains of 1.5 and greater. Because a typical voltage follower configuration has a loop gain of 1, it may be unstable. Several stable G = 1 configurations are listed in Table 8.

DIFFERENTIAL OUTPUT

The AD8270 can easily be configured for differential output. Figure 48 shows the configuration for a G = 1 differential output amplifier. The OCM node in the figure sets the common-mode output voltage. Figure 49 shows the configuration for a G = 1 differential output amplifier, where the average of two voltages sets the common-mode output voltage. For example, this configuration can be used to set the common mode at 2.5 V, using just a 5 V reference and GND.

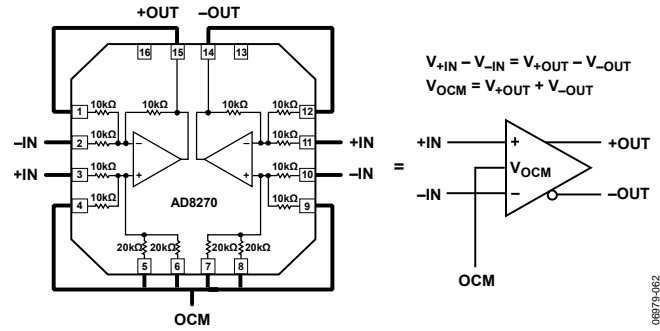

Figure 48. Differential Output, G = 1, Common-Mode Output Voltage Set with Reference Voltage

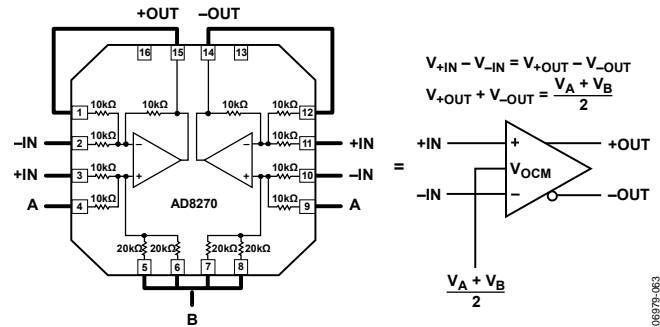

Figure 49. Differential Output, G = 1, Common-Mode Output Voltage Set as the Average of Two Voltages

Note that these two configurations are based on the G = 0.5 difference amplifier configurations shown in Figure 42 and Figure 45. A similar technique can be used to create differential output with a gain of 2 or 4, using the G = 1 and G = 2 difference amplifier configurations, respectively.

AD8270

DRIVING AN ADC

The AD8270 high slew rate and drive capability, combined with its dc accuracy, make it a good ADC driver. The AD8270 can drive both single-ended and differential input ADCs. Many converters require the output to be buffered with a small value resistor combined with a high quality ceramic capacitor. See the converter data sheet for more details. Figure 51 shows the AD8270 in differential configuration, driving the AD7688 ADC. The AD8270 divides down the 5 V reference voltage from the ADR435, so that the common-mode output voltage is 2.5 V, which is precisely where the AD7688 needs it.

DRIVING CABLING

All cables have a certain capacitance per unit length, which varies widely with cable type. The capacitive load from the cable may cause peaking or instability in output response, especially when the AD8270 is operating in a gain of 0.5.

To reduce the peaking, use a resistor between the AD8270 and the cable. Because cable capacitance and desired output response vary widely, this resistor is best determined empirically. A good starting point is 20 Ω .

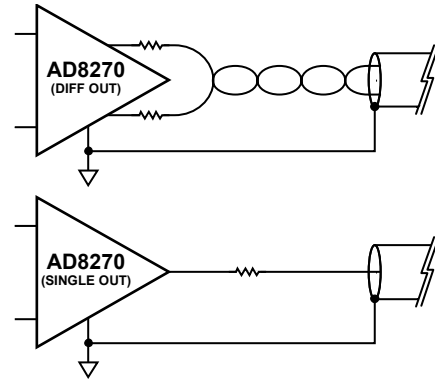

Figure 50. Driving Cabling

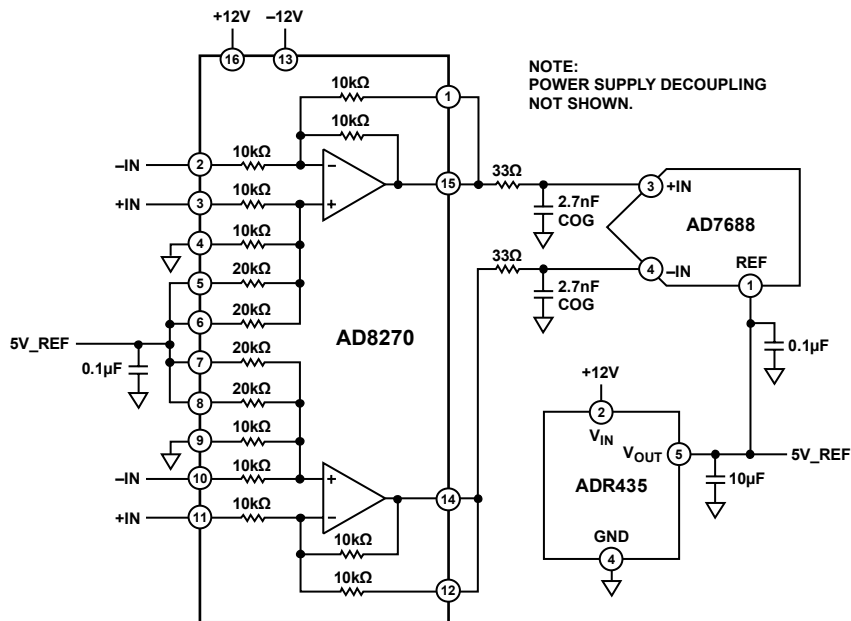
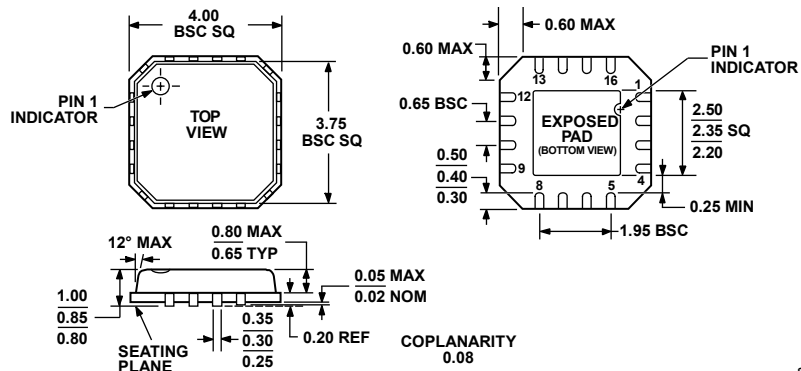

Figure 51. Driving an ADC

OUTLINE DIMENSIONS



COMPLIANT TO JEDEC STANDARDS MO-220-VGGC
 Figure 52. 16-Lead Lead Frame Chip Scale Package [LFCSP_VQ]
 4 mm × 4 mm Body, Very Thin Quad
 (CP-16-10)
 Dimensions are shown in millimeters

010806-0

ORDERING GUIDE

Model	Temperature Range	Package Description	Package Option
AD8270ACPZ-R7 ¹	-40°C to +85°C	16-Lead LFCSP_VQ	CP-16-10
AD8270ACPZ-RL ¹	-40°C to +85°C	16-Lead LFCSP_VQ	CP-16-10
AD8270ACPZ-WP ¹	-40°C to +85°C	16-Lead LFCSP_VQ	CP-16-10

¹ Z = RoHS Compliant Part.

AD8270

NOTES