



Dual, 1MSPS, 16-/14-/12-Bit, 4x2 or 2x2 Channel, Simultaneous Sampling Analog-to-Digital Converter

Check for Samples: [ADS8363](#), [ADS7263](#), [ADS7223](#)

FEATURES

- Eight Pseudo- or Four Fully-Differential Inputs
- Simultaneous Sampling of Two Channels
- Excellent AC Performance:
 - SNR:
 - 93dB (ADS8363)
 - 85dB (ADS7263)
 - 73dB (ADS7223)
 - THD:
 - 98dB (ADS8363)
 - 92dB (ADS7263)
 - 86dB (ADS7223)
- Dual Programmable and Buffered 2.5V Reference Allows:
 - Two Different Input Voltage Range Settings
 - Two-Level PGA Implementation
- Programmable Auto-Sequencer
- Integrated Data Storage (up to 4 per channel) for Oversampling Applications
- 2-Bit Counter for Safety Applications
- Fully Specified over the Extended Industrial Temperature Range

APPLICATIONS

- Motor Control: Current and Position Measurement including Safety Applications
- Power Quality Measurement
- Three-Phase Power Control
- Programmable Logic Controllers
- Industrial Automation
- Protection Relays

DESCRIPTION

The ADS8363 is a dual, 16-bit, 1MSPS analog-to-digital converter (ADC) with eight pseudo- or four fully-differential input channels grouped into two pairs for simultaneous signal acquisition. The analog inputs are maintained differentially to the input of the ADC. The input multiplexer can be used in either pseudo-differential mode, supporting up to four channels per ADC (4x2), or in fully-differential mode that allows to convert up to two inputs per ADC (2x2). The ADS7263 is a 14-bit version while the ADS7223 is a 12-bit version of the ADS8363.

The ADS8363/7263/7223 offer two programmable reference outputs, flexible supply voltage ranges, a programmable auto-sequencer, data storage of up to four conversion results per channel, and several power-down features.

All devices are offered in a 5x5mm QFN-32 package.

Functional Block Diagram

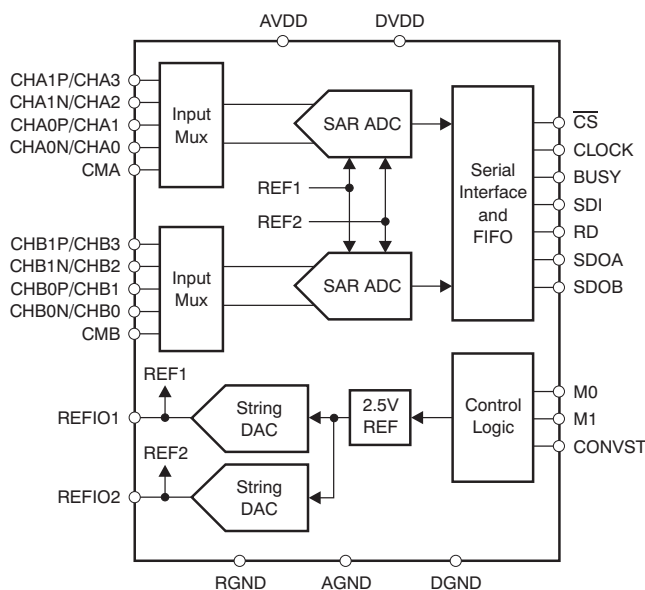

Please be aware that an important notice concerning availability, standard warranty, and use in critical applications of Texas Instruments semiconductor products and disclaimers thereto appears at the end of this data sheet.

All trademarks are the property of their respective owners.



This integrated circuit can be damaged by ESD. Texas Instruments recommends that all integrated circuits be handled with appropriate precautions. Failure to observe proper handling and installation procedures can cause damage.

ESD damage can range from subtle performance degradation to complete device failure. Precision integrated circuits may be more susceptible to damage because very small parametric changes could cause the device not to meet its published specifications.

ORDERING INFORMATION

For the most current package and ordering information, see the Package Option Addendum at the end of this document, or visit the device product folder at www.ti.com.

FAMILY OVERVIEW

PRODUCT	RESOLUTION	NMC	INL	SNR	THD
ADS8363	16 bits	16 or 15 bits ⁽¹⁾	±3 or ±4 LSB ⁽¹⁾	93dB (typ)	–98dB (typ)
ADS7263	14 bits	14 bits	±1 LSB	85dB (typ)	–92dB (typ)
ADS7223	12 bits	12 bits	±0.5 LSB	73dB (typ)	–86dB (typ)

(1) See Electrical Characteristics.

ABSOLUTE MAXIMUM RATINGS⁽¹⁾

Over operating free-air temperature range, unless otherwise noted.

		ADS8363, ADS7263, ADS7223	UNIT
Supply voltage, AVDD to AGND or DVDD to DGND		–0.3 to +6	V
Supply voltage, DVDD to AVDD		1.2 × AVDD ⁽²⁾	V
Analog and reference input voltage with respect to AGND		AGND – 0.3 to AVDD + 0.3	V
Digital input voltage with respect to DGND		DGND – 0.3 to DVDD + 0.3	V
Ground voltage difference AGND-DGND		0.3	V
Input current to any pin except supply pins		–10 to +10	mA
Maximum virtual junction temperature, T _J		+150	°C
Electrostatic discharge (ESD) ratings, all pins	Human body model (HBM), JEDEC standard 22, test method A114-C.01	±2000	V
	Charged device model (CDM), JEDEC standard 22, test method C101	±500	V

- Stresses above these ratings may cause permanent damage to the device. These are stress ratings only, and functional operation of the device at these or any other conditions beyond those specified is not implied. Exposure to absolute maximum conditions for extended periods may affect device reliability.
- Exceeding the specified limit causes an increase of the DVDD leakage current and leads to malfunction of the device.

THERMAL INFORMATION

THERMAL METRIC ⁽¹⁾		ADS8363, ADS7263, ADS7223	UNITS
		RHB	
		32 PINS	
θ _{JA}	Junction-to-ambient thermal resistance	33.3	°C/W
θ _{JCtop}	Junction-to-case (top) thermal resistance	29.5	
θ _{JB}	Junction-to-board thermal resistance	7.3	
ψ _{JT}	Junction-to-top characterization parameter	0.2	
ψ _{JB}	Junction-to-board characterization parameter	7.4	
θ _{JCbot}	Junction-to-case (bottom) thermal resistance	0.9	

(1) For more information about traditional and new thermal metrics, see the *IC Package Thermal Metrics* application report, [SPRA953](http://www.ti.com/lit/zip/spra953).

ELECTRICAL CHARACTERISTICS: ADS8363

All minimum/maximum specifications at $T_A = -40^\circ\text{C}$ to $+125^\circ\text{C}$, specified supply voltage range, $V_{REF} = 2.5\text{V}$ (int), and $t_{\text{DATA}} = 1\text{MSPS}$, unless otherwise noted. Typical values are at $T_A = +25^\circ\text{C}$, $AVDD = 5\text{V}$, and $DVDD = 3.3\text{V}$.

PARAMETER	TEST CONDITIONS	ADS8363			UNIT	
		MIN	TYP	MAX		
RESOLUTION		16			Bits	
DC ACCURACY						
INL	Integral nonlinearity	Half-clock mode	-3	± 1.2	+3	LSB
		Full-clock mode	-4	± 1.5	+4	LSB
DNL	Differential nonlinearity	Half-clock mode	-0.99	± 0.6	+2	LSB
		Full-clock mode	-1.5	± 0.8	+3	LSB
V_{OS}	Input offset error		-2	± 0.2	+2	mV
		V_{OS} match	ADC to ADC	-1	± 0.1	+1
dV_{OS}/dT	Input offset thermal drift			1		$\mu\text{V}/^\circ\text{C}$
G_{ERR}	Gain error	Referenced to the voltage at REFIOx	-0.1	± 0.01	+0.1	%
		G_{ERR} match	ADC to ADC	-0.1	± 0.005	+0.1
G_{ERR}/dT	Gain error thermal drift	Referenced to the voltage at REFIOx		1		ppm/ $^\circ\text{C}$
CMRR	Common-mode rejection ratio	Both ADCs, dc to 100kHz		92		dB
AC ACCURACY						
SINAD	Signal-to-noise + distortion	$V_{IN} = 5V_{PP}$ at 10kHz	89	92		dB
SNR	Signal-to-noise ratio	$V_{IN} = 5V_{PP}$ at 10kHz	90	93		dB
THD	Total harmonic distortion	$V_{IN} = 5V_{PP}$ at 10kHz		-98	-90	dB
SFDR	Spurious-free dynamic range	$V_{IN} = 5V_{PP}$ at 10kHz	90	100		dB

ELECTRICAL CHARACTERISTICS: ADS7263

All minimum/maximum specifications at $T_A = -40^\circ\text{C}$ to $+125^\circ\text{C}$, specified supply voltage range, $V_{REF} = 2.5\text{V}$ (int), and $t_{\text{DATA}} = 1\text{MSPS}$, unless otherwise noted. Typical values are at $T_A = +25^\circ\text{C}$, $AVDD = 5\text{V}$, and $DVDD = 3.3\text{V}$.

PARAMETER	TEST CONDITIONS	ADS7263			UNIT	
		MIN	TYP	MAX		
RESOLUTION		14			Bits	
DC ACCURACY						
INL	Integral nonlinearity		-1	± 0.4	+1	LSB
DNL	Differential nonlinearity		-0.5	± 0.2	+1	LSB
V_{OS}	Input offset error		-2	± 0.2	+2	mV
		V_{OS} match	ADC to ADC	-1	± 0.1	+1
dV_{OS}/dT	Input offset thermal drift			1		$\mu\text{V}/^\circ\text{C}$
G_{ERR}	Gain error	Referenced to the voltage at REFIOx	-0.1	± 0.01	+0.1	%
		G_{ERR} match	ADC to ADC	-0.1	± 0.005	+0.1
G_{ERR}/dT	Gain error thermal drift	Referenced to the voltage at REFIOx		1		ppm/ $^\circ\text{C}$
CMRR	Common-mode rejection ratio	Both ADCs, dc to 100kHz		92		dB
AC ACCURACY						
SINAD	Signal-to-noise + distortion	$V_{IN} = 5V_{PP}$ at 10kHz	82	84		dB
SNR	Signal-to-noise ratio	$V_{IN} = 5V_{PP}$ at 10kHz	84	85		dB
THD	Total harmonic distortion	$V_{IN} = 5V_{PP}$ at 10kHz		-92	-88	dB
SFDR	Spurious-free dynamic range	$V_{IN} = 5V_{PP}$ at 10kHz	88	92		dB

ELECTRICAL CHARACTERISTICS: ADS7223

All minimum/maximum specifications at $T_A = -40^\circ\text{C}$ to $+125^\circ\text{C}$, specified supply voltage range, $V_{REF} = 2.5\text{V}$ (int), and $t_{\text{DATA}} = 1\text{MSPS}$, unless otherwise noted. Typical values are at $T_A = +25^\circ\text{C}$, $AVDD = 5\text{V}$, and $DVDD = 3.3\text{V}$.

PARAMETER	TEST CONDITIONS	ADS7223			UNIT	
		MIN	TYP	MAX		
RESOLUTION		12			Bits	
DC ACCURACY						
INL	Integral nonlinearity	-0.5	± 0.2	+0.5	LSB	
DNL	Differential nonlinearity	-0.5	± 0.1	+0.5	LSB	
V_{OS}	Input offset error	-2	± 0.2	+2	mV	
	V_{OS} match	ADC to ADC	-1	± 0.1	+1	mV
dV_{OS}/dT	Input offset thermal drift		1		$\mu\text{V}/^\circ\text{C}$	
G_{ERR}	Gain error	Referenced to the voltage at REFIOx	-0.1	± 0.01	+0.1	%
	G_{ERR} match	ADC to ADC	-0.1	± 0.005	+0.1	%
G_{ERR}/dT	Gain error thermal drift	Referenced to the voltage at REFIOx		1		ppm/ $^\circ\text{C}$
CMRR	Common-mode rejection ratio	Both ADCs, dc to 100kHz		92		dB
AC ACCURACY						
SINAD	Signal-to-noise + distortion	$V_{IN} = 5V_{PP}$ at 10kHz	71	72		dB
SNR	Signal-to-noise ratio	$V_{IN} = 5V_{PP}$ at 10kHz	72	73		dB
THD	Total harmonic distortion	$V_{IN} = 5V_{PP}$ at 10kHz		-86	-84	dB
SFDR	Spurious-free dynamic range	$V_{IN} = 5V_{PP}$ at 10kHz	84	86		dB

ELECTRICAL CHARACTERISTICS: GENERAL

All minimum/maximum specifications at $T_A = -40^\circ\text{C}$ to $+125^\circ\text{C}$, specified supply voltage range, $V_{REF} = 2.5\text{V}$ (int), and $t_{\text{DATA}} = 1\text{MSPS}$, unless otherwise noted. Typical values are at $T_A = +25^\circ\text{C}$, $AVDD = 5\text{V}$, and $DVDD = 3.3\text{V}$.

PARAMETER	TEST CONDITIONS	ADS8363, ADS7263, ADS7223			UNIT
		MIN	TYP	MAX	
ANALOG INPUT					
FSR	Full-scale input range	(CHxxP – CHxxN) or CHxx to CMx	$-V_{REF}$	$+V_{REF}$	V
V_{IN}	Absolute input voltage	CHxxx to AGND	-0.1	$AVDD + 0.1$	V
C_{IN}	Input capacitance	CHxxx to AGND		45	pF
C_{ID}	Differential input capacitance			22.5	pF
I_{IL}	Input leakage current		-16	16	nA
PSRR	Power-supply rejection ratio	$AVDD = 5.5\text{V}$		75	dB
SAMPLING DYNAMICS					
t_{CONV}	Conversion time per ADC	Half-clock mode	17.5		t_{CLK}
		Full-clock mode	35		t_{CLK}
t_{ACQ}	Acquisition time	Half-clock mode	2		t_{CLK}
		Full-clock Mode	4		t_{CLK}
f_{DATA}	Data rate		25	1000	kSPS
t_A	Aperture delay			6	ns
	t_A match	ADC to ADC		50	ps
t_{AJIT}	Aperture jitter			50	ps
f_{CLK}	Clock frequency	Half-clock mode	0.5	20	MHz
		Full-clock mode	1	40	MHz
t_{CLK}	Clock period	Half-clock mode	50	2000	ns
		Full-clock mode	25	1000	ns

ELECTRICAL CHARACTERISTICS: GENERAL (continued)

All minimum/maximum specifications at $T_A = -40^{\circ}\text{C}$ to $+125^{\circ}\text{C}$, specified supply voltage range, $V_{REF} = 2.5\text{V}$ (int), and $t_{\text{DATA}} = 1\text{MSPS}$, unless otherwise noted. Typical values are at $T_A = +25^{\circ}\text{C}$, $AVDD = 5\text{V}$, and $DVDD = 3.3\text{V}$.

PARAMETER	TEST CONDITIONS	ADS8363, ADS7263, ADS7223			UNIT	
		MIN	TYP	MAX		
INTERNAL VOLTAGE REFERENCE						
Resolution	Reference output DAC resolution	10			Bits	
V_{REFOUT}	Reference output voltage	Over 20% to 100% DAC range	$0.2V_{\text{REFOUT}}$		V_{REFOUT}	
		REFIO1, DAC = 3FFh,	2.485	2.500	2.515	
		REFIO2, DAC = 3FFh	2.480	2.500	2.520	
dV_{REFOUT}/dT	Reference voltage drift	± 10			ppm/ $^{\circ}\text{C}$	
DNL_{DAC}	DAC differential linearity error	-4	± 1	4	LSB	
INL_{DAC}	DAC integral linearity error	-4	± 0.5	4	LSB	
V_{OSDAC}	DAC offset error	$V_{\text{REFOUT}} = 0.5\text{V}$			LSB	
PSRR	Power-supply rejection ratio	73			dB	
I_{REFOUT}	Reference output dc current	-2			+2	
I_{REFSC}	Reference output short-circuit current ⁽¹⁾	50			mA	
t_{REFON}	Reference output settling time	$C_{\text{REF}} = 22\mu\text{F}$			8	
VOLTAGE REFERENCE INPUT						
V_{REF}	Reference input voltage range	0.5	2.5	2.525	V	
I_{REF}	Reference input current	50			μA	
C_{REF}	External ceramic reference capacitance	22			μF	
DIGITAL INPUTS⁽²⁾						
I_{IN}	Input current	$V_{\text{IN}} = DVDD$ to DGND			-50	+50
C_{IN}	Input capacitance				5	pF
	Logic family				CMOS with Schmitt-Trigger	
V_{IH}	High-level input voltage	$DVDD = 4.5\text{V}$ to 5.5V			$0.7DVDD$	$DVDD + 0.3$
V_{IL}	Low-level input voltage	$DVDD = 4.5\text{V}$ to 5.5V			-0.3	$0.3DVDD$
	Logic family				LVCMOS	
V_{IH}	High-level input voltage	$DVDD = 2.3\text{V}$ to 3.6V			2	$DVDD + 0.3$
V_{IL}	Low-level input voltage	$DVDD = 2.3\text{V}$ to 3.6V			-0.3	0.8
DIGITAL OUTPUTS⁽²⁾						
C_{OUT}	Output capacitance				5	pF
C_{LOAD}	Load capacitance				30	pF
	Logic family				CMOS	
V_{OH}	High-level output voltage	$DVDD = 4.5\text{V}$, $I_{\text{OH}} = -100\mu\text{A}$			4.44	V
V_{OL}	Low-level output voltage	$DVDD = 4.5\text{V}$, $I_{\text{OH}} = +100\mu\text{A}$			0.5	
	Logic family				LVCMOS	
V_{OH}	High-level output voltage	$DVDD = 2.3\text{V}$, $I_{\text{OH}} = -100\mu\text{A}$			$DVDD - 0.2$	
V_{OL}	Low-level output voltage	$DVDD = 2.3\text{V}$, $I_{\text{OH}} = +100\mu\text{A}$			0.2	V

(1) Reference output current is not internally limited.

(2) Specified by design; not production tested.

ELECTRICAL CHARACTERISTICS: GENERAL (continued)

All minimum/maximum specifications at $T_A = -40^{\circ}\text{C}$ to $+125^{\circ}\text{C}$, specified supply voltage range, $V_{REF} = 2.5\text{V}$ (int), and $t_{\text{DATA}} = 1\text{MSPS}$, unless otherwise noted. Typical values are at $T_A = +25^{\circ}\text{C}$, $AVDD = 5\text{V}$, and $DVDD = 3.3\text{V}$.

PARAMETER	TEST CONDITIONS	ADS8363, ADS7263, ADS7223			UNIT	
		MIN	TYP	MAX		
POWER SUPPLY						
AVDD	Analog supply voltage	AVDD to AGND, half-clock mode	2.7	5.0	5.5	V
		AVDD to AGND, full-clock mode	4.5	5.0	5.5	V
DVDD	Digital supply voltage	3V and 3.3V levels	2.3	2.5	3.6	V
		5V levels, half-clock mode only	4.5	5.0	5.5	V
AIDD	Analog supply current	AVDD = 3.6V		12.0	16.0	mA
		AVDD = 5.5V		15.0	20.0	mA
		AVDD = 3.6V, sleep/auto-sleep modes		0.8	1.2	mA
		AVDD = 5.5V, sleep/auto-sleep modes		0.9	1.4	mA
		Power-down mode			0.005	mA
DIDD	Digital supply current	DVDD = 3.6V, $C_{\text{LOAD}} = 10\text{pF}$		1.1	2.5	mA
		DVDD = 5.5V, $C_{\text{LOAD}} = 10\text{pF}$		3	6	mA
P_D	Power dissipation (normal operation)	AVDD = DVDD = 3.6V		47.2	66.6	mW
		AVDD = 5.5V, DVDD = 3.6V		86.5	117.0	mW

PIN CONFIGURATION

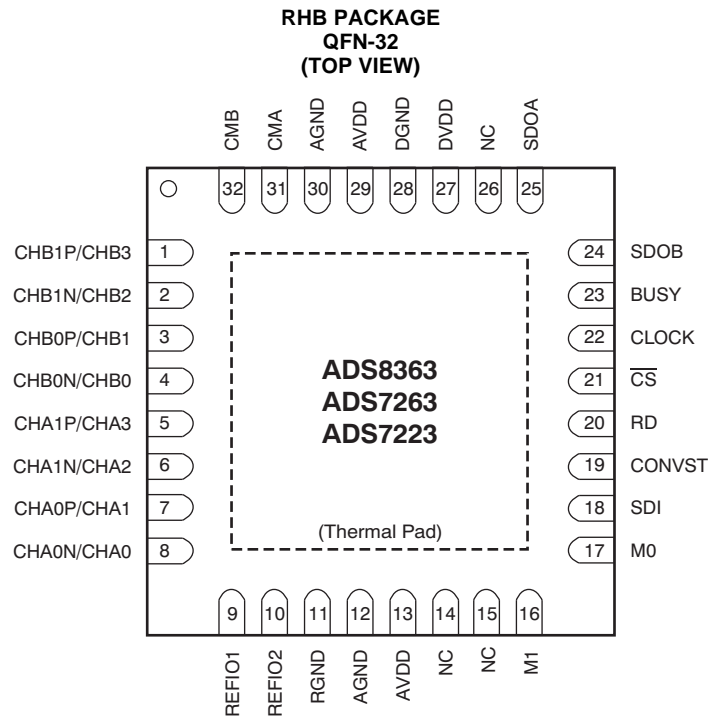

Pin Descriptions

PIN		TYPE ⁽¹⁾	DESCRIPTION
NAME	NO.		
CHB1P/CHB3	1	AI	Fully-differential noninverting analog input channel B1 or pseudo-differential input B3
CHB1N/CHB2	2	AI	Fully-differential inverting analog input channel B1 or pseudo-differential input B2
CHB0P/CHB1	3	AI	Fully-differential noninverting analog input channel B0 or pseudo-differential input B1
CHB0N/CHB0	4	AI	Fully-differential inverting analog input channel B0 or pseudo-differential input B0
CHA1P/CHA3	5	AI	Fully-differential noninverting analog input channel A1 or pseudo-differential input A3
CHA1N/CHA2	6	AI	Fully-differential inverting analog input channel A1 or pseudo-differential input A2
CHA0P/CHA1	7	AI	Fully-differential noninverting analog input channel A1 or pseudo-differential input A1
CHA0N/CHA0	8	AI	Fully-differential inverting analog input channel A1 or pseudo-differential input A0
REFIO1	9	AIO	Reference voltage input/output 1. A ceramic capacitor of 22µF connected to RGND is required.
REFIO2	10	AIO	Reference voltage input/output 2. A ceramic capacitor of 22µF connected to RGND is required.
RGND	11	P	Reference ground. Connect to analog ground plane with a dedicated via.
AGND	12, 30	P	Analog ground. Connect to analog ground plane.
AVDD	13, 29	P	Analog power supply, 2.7V to 5.5V. Decouple to AGND with a 1µF ceramic capacitor.
NC	14, 15, 26	NC	This pin is not internally connected.
M1	16	DI	Mode pin 1. Selects the digital output mode (see Table 4).
M0	17	DI	Mode pin 0. Selects analog input channel mode (see Table 4).
SDI	18	DI	Serial data input. This pin is used to set up of the internal registers, and can also be used in ADS8361-compatible manner. The data on SDI are ignored when CS is high.
CONVST	19	DI	Conversion start. The ADC switches from sample into hold mode on the rising edge of CONVST. Thereafter, the conversion starts with the next rising edge of the CLOCK pin.
RD	20	DI	Read data. Synchronization pulse for the SDOx outputs and SDI input. RD only triggers when CS is low.

(1) AI = analog input, AIO = analog input/output, DI = digital input, DO = digital output, DIO = digital input/output, P = power supply, NC = not connected.

Pin Descriptions (continued)

PIN		TYPE ⁽¹⁾	DESCRIPTION
NAME	NO.		
\overline{CS}	21	DI	Chip select. When this pin is low, the SDOx, SDI, and RD pins are active; when this pin is high, the SDOx outputs are 3-stated, while the SDI and RD inputs are ignored.
CLOCK	22	DI	External clock input. The range is 0.5MHz to 20MHz in half-clock mode, or 1MHz to 40MHz in full-clock mode.
BUSY	23	DO	Converter busy indicator. BUSY goes high when the inputs are in hold mode and returns to low after the conversion is complete.
SDOB	24	DO	Serial data output for converter B. Active only if M1 is low. 3-state when \overline{CS} is high.
SDOA	25	DO	Serial data output for converter A. 3-state when \overline{CS} is high.
DVDD	27	P	Digital supply, 2.3V to 5.5V. Decouple to DGND with a 1µF ceramic capacitor.
DGND	28	P	Digital ground. Connect to digital ground plane.
CMA	31	AI	Common-mode voltage input for channels Ax (in pseudo-differential mode only).
CMB	32	AI	Common-mode voltage input for channels Bx (in pseudo-differential mode only).

TIMING DIAGRAMS

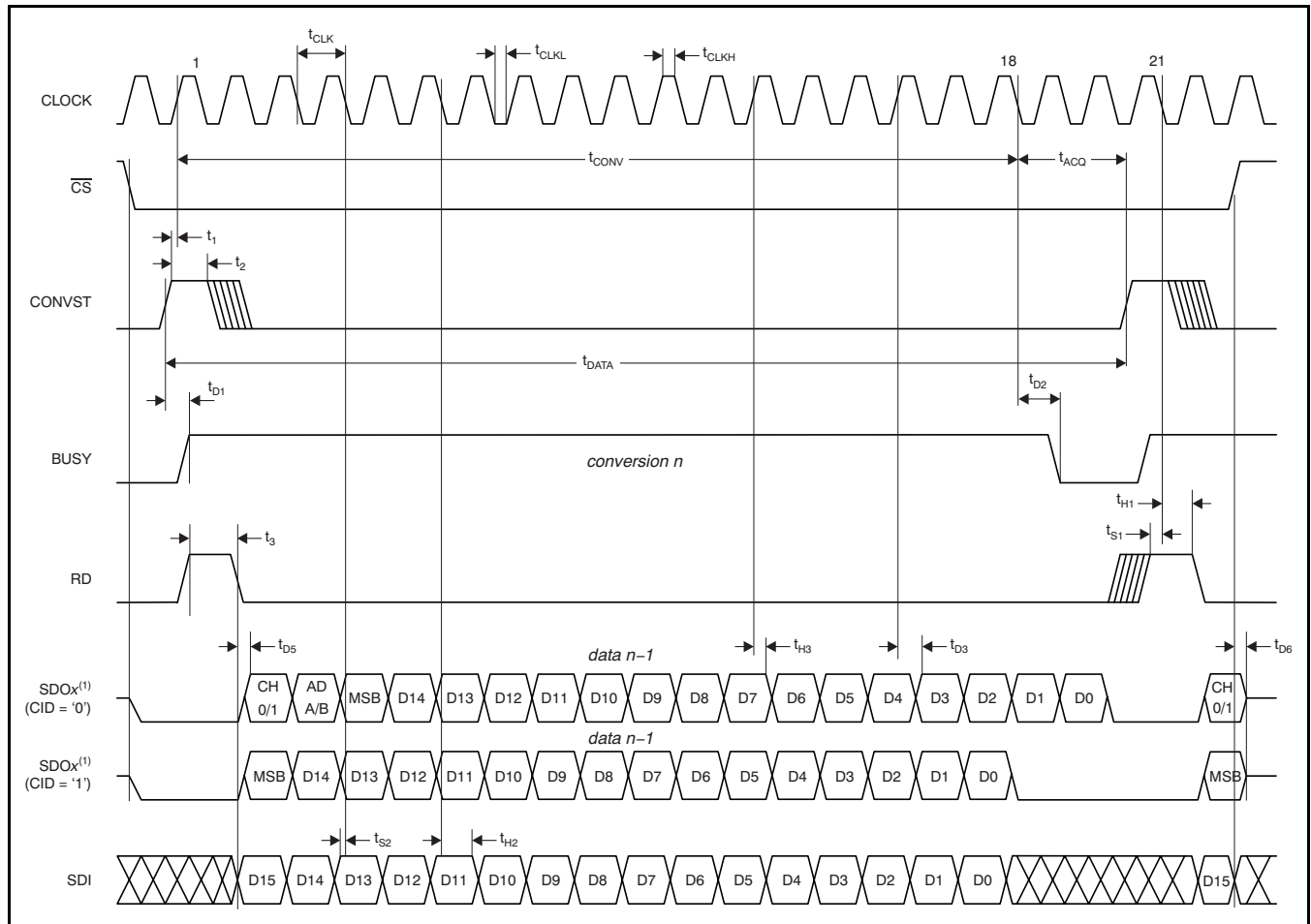

(1) The ADS7263/7223 output data with the MSB located as ADS8363 and last 2/4 bits being '0'.

Figure 1. Detailed Timing Diagram: Half-Clock Mode (ADS8361-Compatible)

TIMING DIAGRAMS (continued)

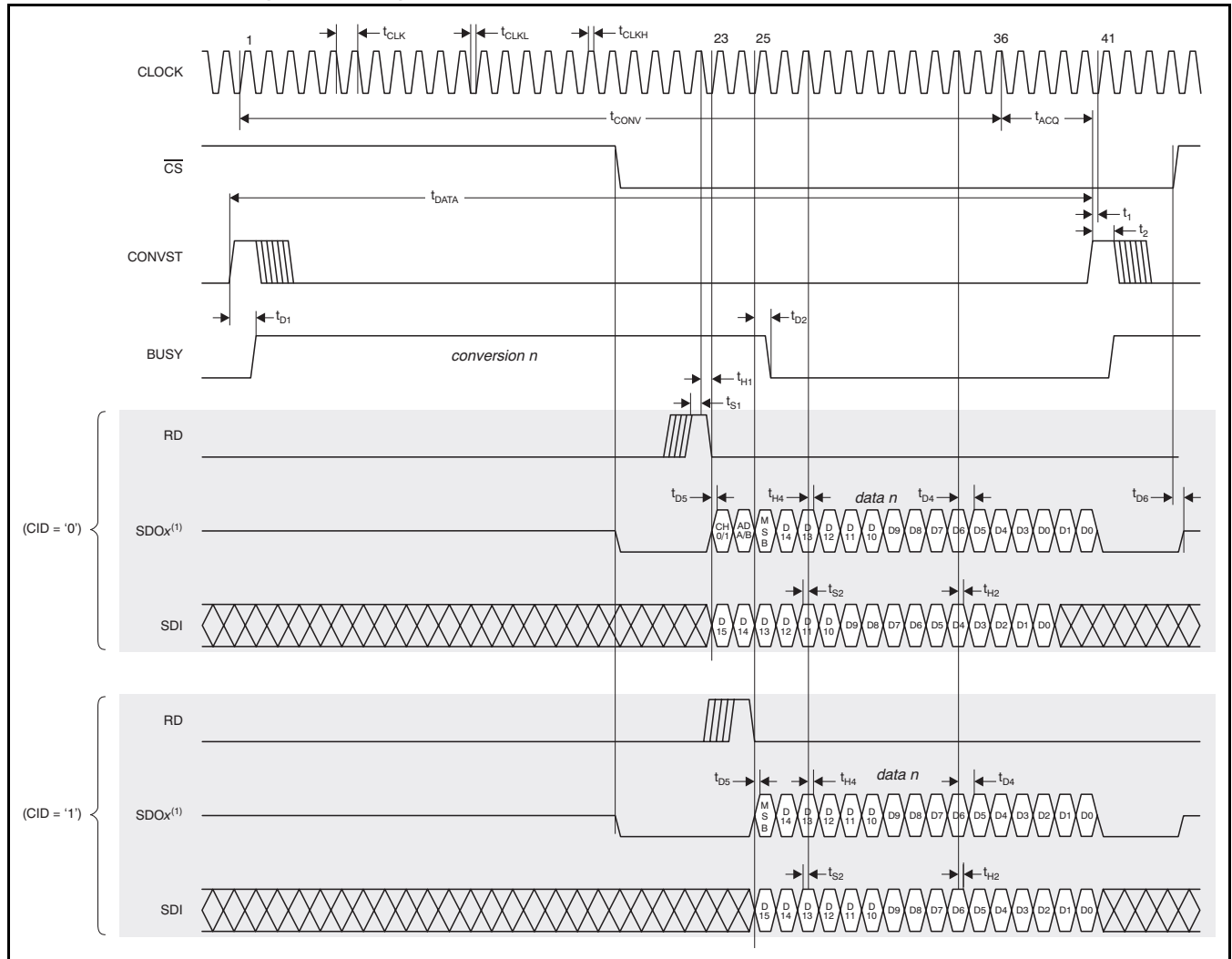

(2) The ADS7263/7223 output data with the MSB located as ADS8363 and last 2/4 bits being '0'.

Figure 2. Detailed Timing Diagram: Full-Clock Mode

TIMING CHARACTERISTICS⁽¹⁾

Over the recommended operating free-air temperature range of -40°C to $+125^{\circ}\text{C}$, and DVDD = 2.3V to 5.5V, unless otherwise noted.

PARAMETER		TEST CONDITIONS	ADS8363, 7263, 7223		UNIT
			MIN	MAX	
t_{DATA}	Data throughput	$f_{\text{CLK}} = \text{max}$	1		μs
t_{CONV}	Conversion time	Half-clock mode	17.5		t_{CLK}
		Full-clock mode	35		t_{CLK}
t_{ACQ}	Acquisition time		100		ns
f_{CLK}	CLOCK frequency	Half-clock mode	0.5	20	MHz
		Full-clock mode	1	40	MHz
t_{CLK}	CLOCK period	Half-clock mode	50	2000	ns
		Full-clock mode	25	1000	ns
t_{CLKL}	CLOCK low time		11.25		ns
t_{CLKH}	CLOCK high time		11.25		ns
t_1	CONVST rising edge to first CLOCK rising edge		12		ns
t_2	CONVST high time		10		ns
		Half-clock mode: timing modes II and IV only		1	t_{CLK}
t_3	RD high time	Half-clock mode: timing modes II, IV, SII, and SIV only		1	t_{CLK}
t_{S1}	RD high to CLOCK falling edge setup time		5		ns
t_{H1}	RD high to CLOCK falling edge hold time		5		ns
t_{S2}	Input data to CLOCK falling edge setup time		5		ns
t_{H2}	Input data to CLOCK falling edge hold time		4		ns
t_{D1}	CONVST rising edge to BUSY high delay ⁽²⁾	2.3V < DVDD < 3.6V		19	ns
		4.5V < DVDD < 5.5V		16	ns
t_{D2}	CLOCK 18th falling edge (half-clock mode) or 24th rising edge (full-clock mode) to BUSY low delay	2.3V < DVDD < 3.6V		25	ns
		4.5V < DVDD < 5.5V		20	ns
t_{D3}	CLOCK rising edge to next data valid delay	Half-clock mode, 2.3V < DVDD < 3.6V		14	ns
		Half-clock mode, 4.5V < DVDD < 5.5V		12	ns
t_{H3}	Output data to CLOCK rising edge hold time	Half-clock mode	3		ns
t_{D4}	CLOCK falling edge to next data valid delay	Full-clock mode		19	ns
t_{H4}	Output data to CLOCK falling edge hold time	Full-clock mode	7		ns
t_{D5}	RD falling edge to first data valid	2.3V < DVDD < 3.6V		16	ns
		4.5V < DVDD < 5.5V		12	ns
t_{D6}	$\overline{\text{CS}}$ rising edge to SDOx 3-state			6	ns

(1) All input signals are specified with $t_{\text{R}} = t_{\text{F}} = 1.5\text{ns}$ (10% to 90% of DVDD) and timed from a voltage level of $(V_{\text{IL}} + V_{\text{IH}})/2$.

(2) Not applicable in auto-sleep power-down mode.

TYPICAL CHARACTERISTICS

At $T_A = +25^\circ\text{C}$, $AV_{DD} = 5\text{V}$, $DV_{DD} = 3.3\text{V}$, $V_{REF} = 2.5\text{V}$ (internal), and $f_{DATA} = 1\text{MSPS}$, unless otherwise noted.

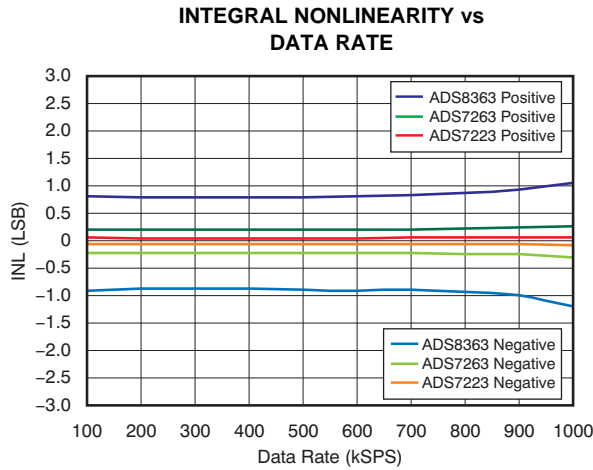

Figure 3.

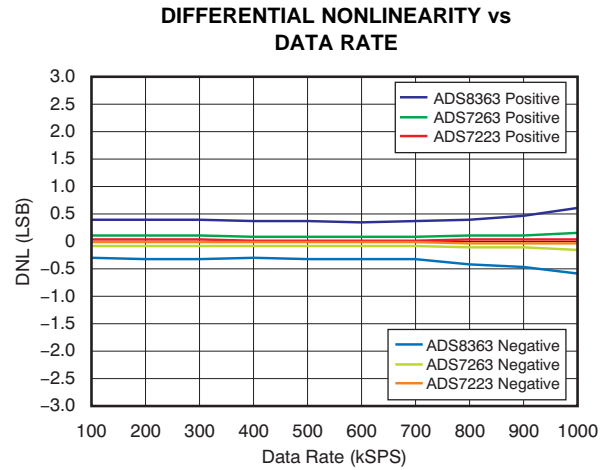

Figure 4.

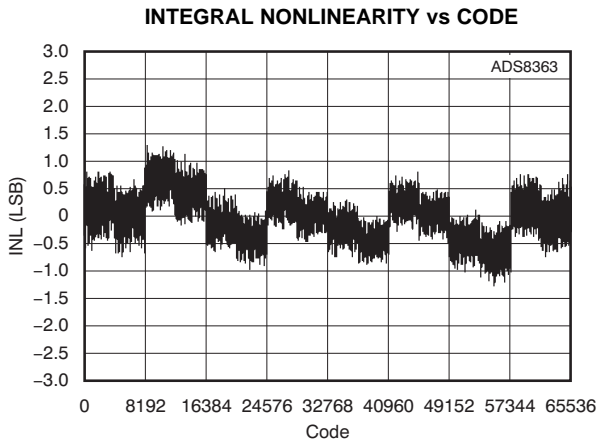

Figure 5.

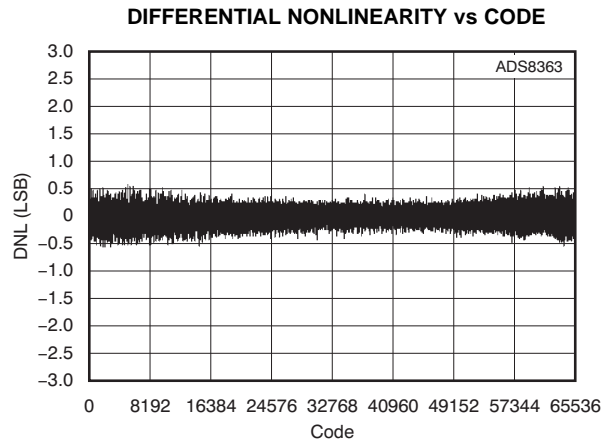

Figure 6.

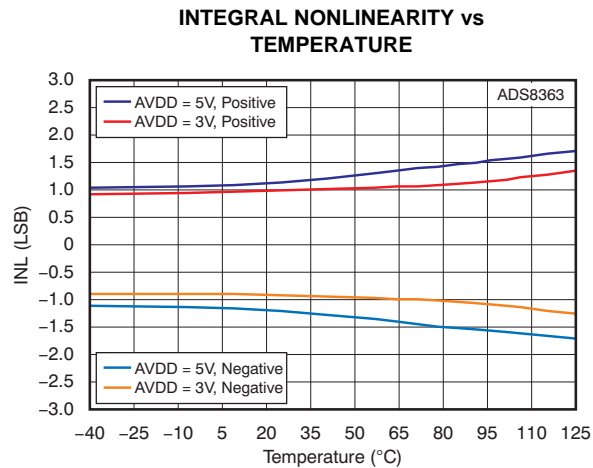

Figure 7.

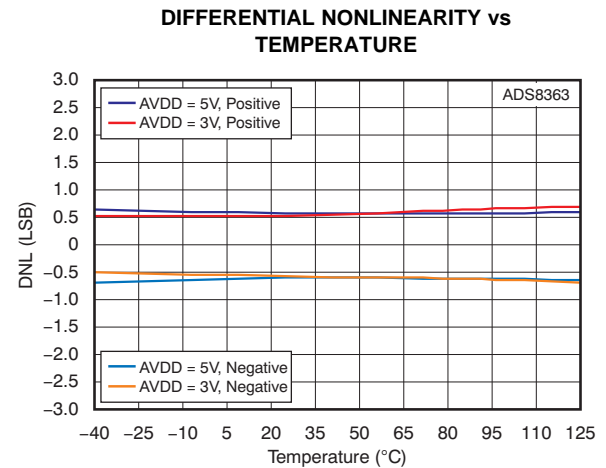

Figure 8.

TYPICAL CHARACTERISTICS (continued)

At $T_A = +25^\circ\text{C}$, $AV_{DD} = 5\text{V}$, $DV_{DD} = 3.3\text{V}$, $V_{REF} = 2.5\text{V}$ (internal), and $f_{DATA} = 1\text{MSPS}$, unless otherwise noted.

**OFFSET ERROR AND OFFSET MATCH vs
ANALOG SUPPLY VOLTAGE**

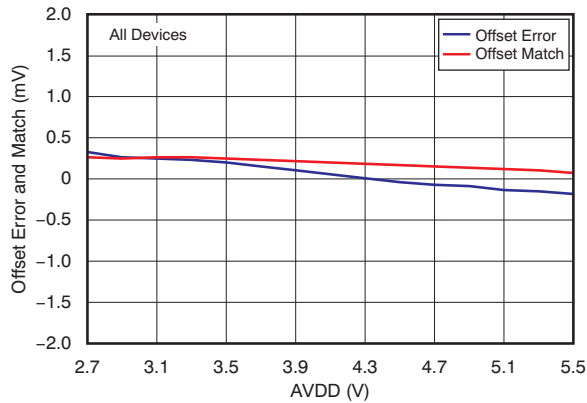

Figure 9.

**OFFSET ERROR AND OFFSET MATCH vs
TEMPERATURE**

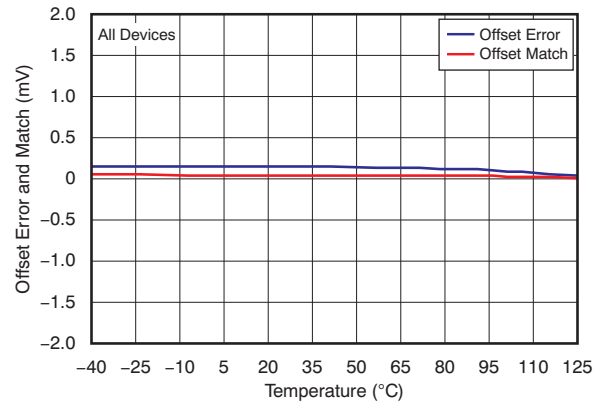

Figure 10.

**GAIN ERROR AND GAIN MATCH vs
ANALOG SUPPLY VOLTAGE**

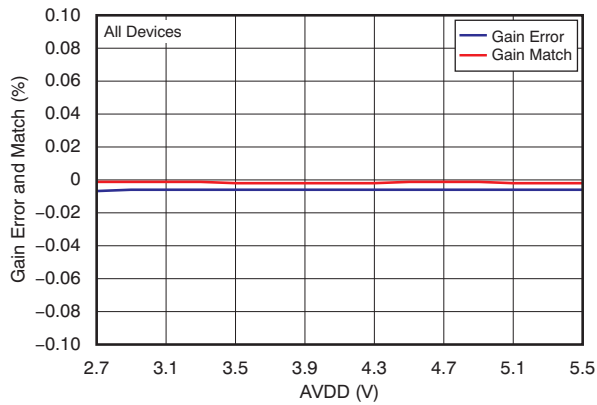

Figure 11.

**GAIN ERROR AND GAIN MATCH vs
TEMPERATURE**

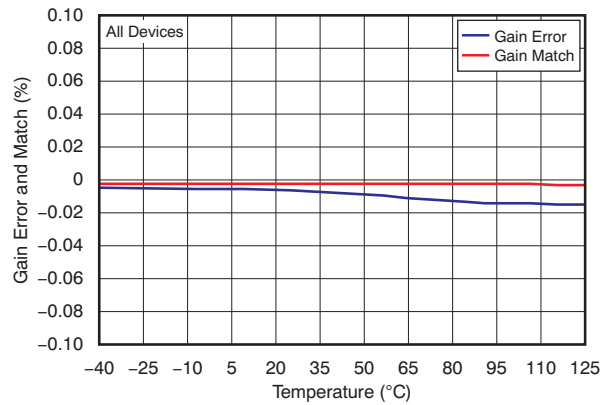

Figure 12.

**COMMON-MODE REJECTION RATIO vs
ANALOG SUPPLY VOLTAGE**

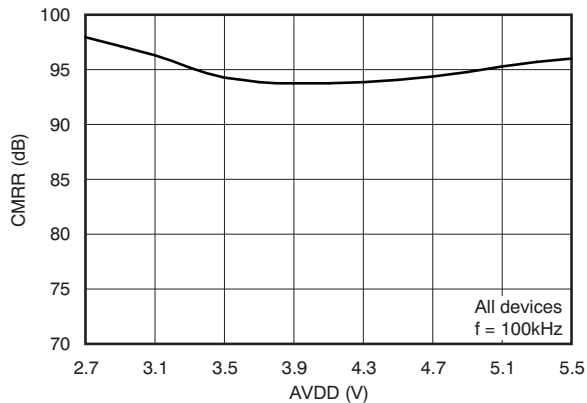

Figure 13.

**COMMON-MODE REJECTION RATIO vs
TEMPERATURE**

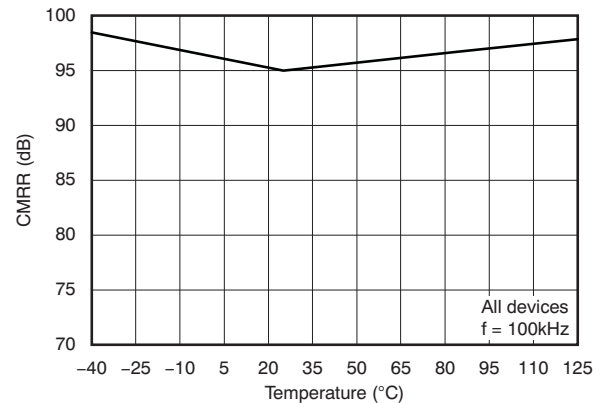

Figure 14.

TYPICAL CHARACTERISTICS (continued)

At $T_A = +25^\circ\text{C}$, $AVDD = 5\text{V}$, $DVDD = 3.3\text{V}$, $V_{REF} = 2.5\text{V}$ (internal), and $f_{\text{DATA}} = 1\text{MSPS}$, unless otherwise noted.

FREQUENCY SPECTRUM
 (4096 Point FFT; $f_{\text{IN}} = 10\text{kHz}$)

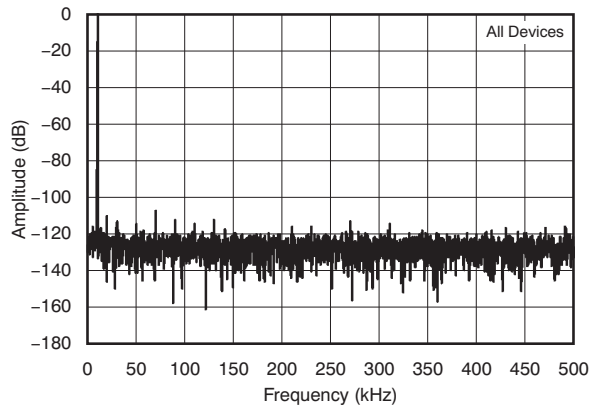

Figure 15.

FREQUENCY SPECTRUM
 (4096 Point FFT; $f_{\text{IN}} = 10\text{kHz}$, $f_{\text{SAMPLE}} = 0.5\text{MSPS}$)

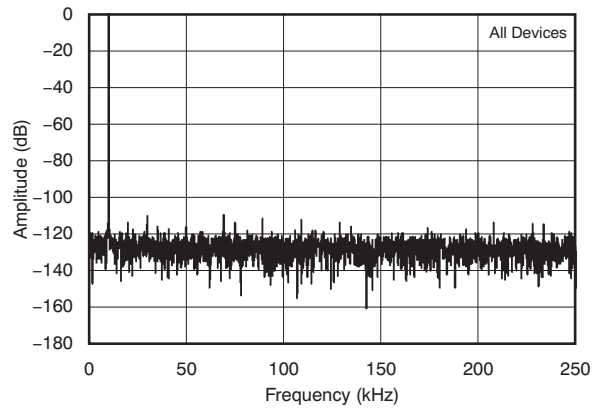

Figure 16.

SIGNAL-TO-NOISE RATIO AND SIGNAL-TO-NOISE + DISTORTION vs INPUT SIGNAL FREQUENCY

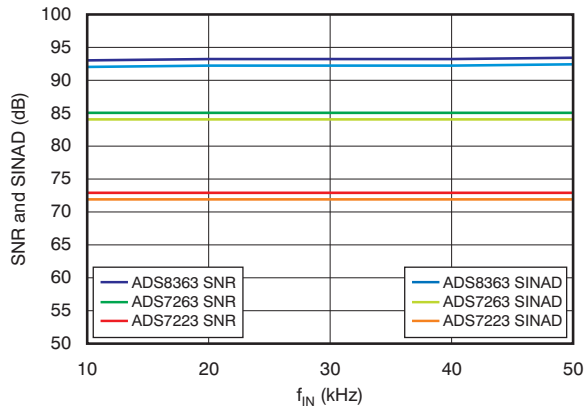

Figure 17.

SIGNAL-TO-NOISE RATIO AND SIGNAL-TO-NOISE + DISTORTION vs TEMPERATURE

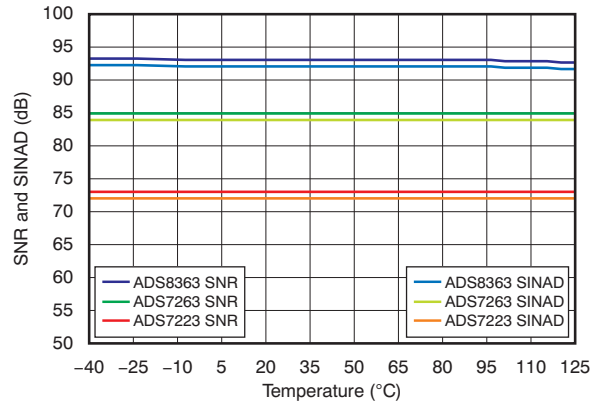

Figure 18.

TOTAL HARMONIC DISTORTION vs INPUT SIGNAL FREQUENCY

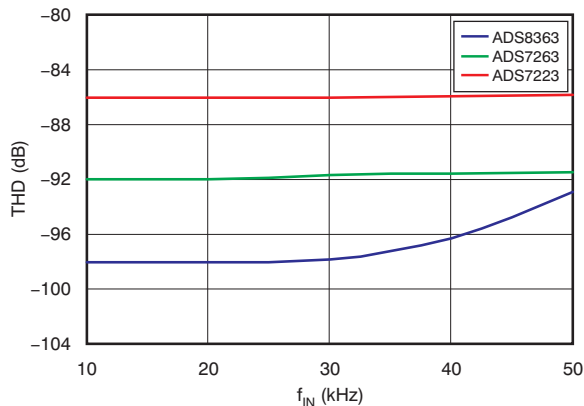

Figure 19.

TOTAL HARMONIC DISTORTION vs TEMPERATURE

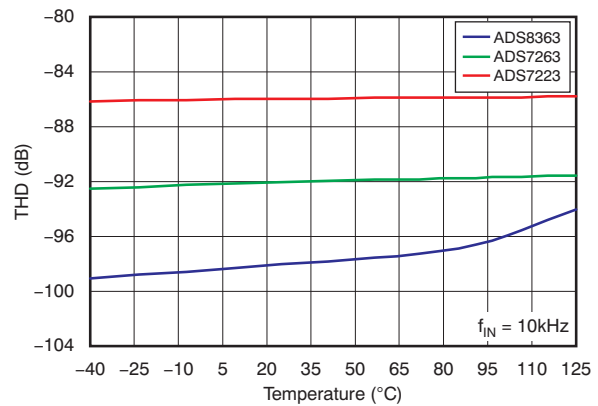

Figure 20.

TYPICAL CHARACTERISTICS (continued)

At $T_A = +25^\circ\text{C}$, $AVDD = 5\text{V}$, $DVDD = 3.3\text{V}$, $V_{REF} = 2.5\text{V}$ (internal), and $f_{DATA} = 1\text{MSPS}$, unless otherwise noted.

SPURIOUS-FREE DYNAMIC RANGE vs INPUT SIGNAL FREQUENCY

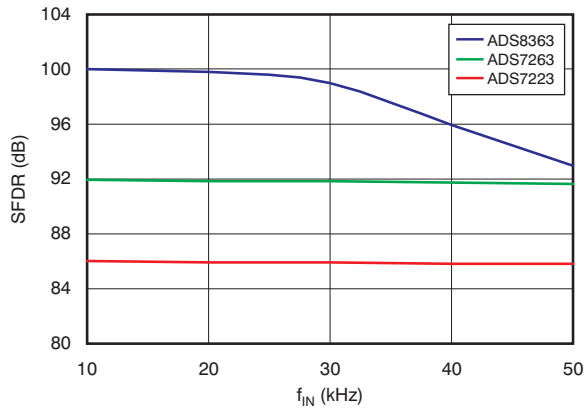

Figure 21.

SPURIOUS-FREE DYNAMIC RANGE vs TEMPERATURE

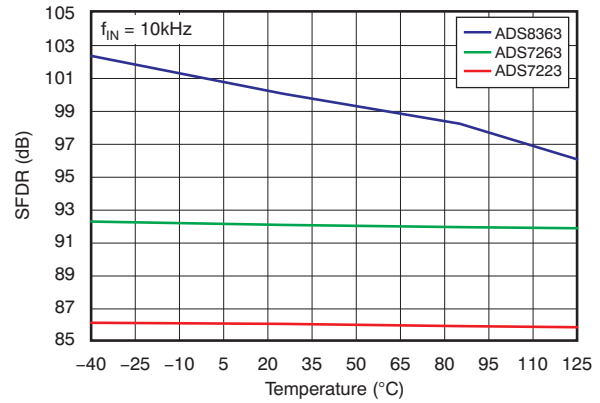

Figure 22.

ANALOG SUPPLY CURRENT vs TEMPERATURE

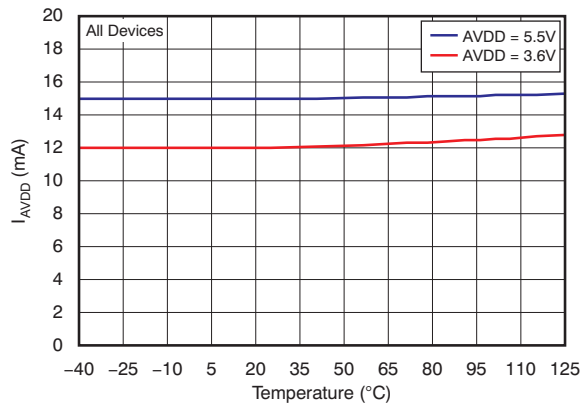

Figure 23.

DIGITAL SUPPLY CURRENT vs TEMPERATURE

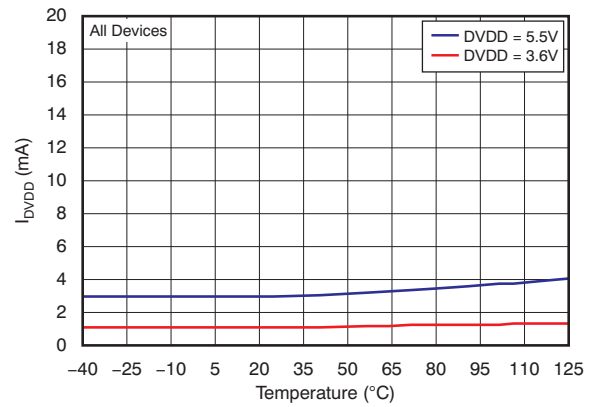

Figure 24.

ANALOG SUPPLY CURRENT vs DATA RATE

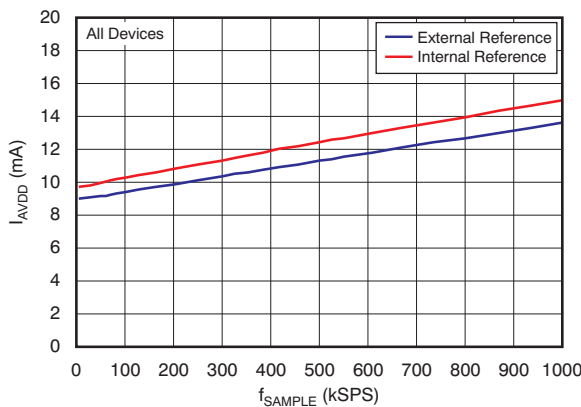

Figure 25.

ANALOG SUPPLY CURRENT vs DATA RATE (Auto-Sleep Mode)

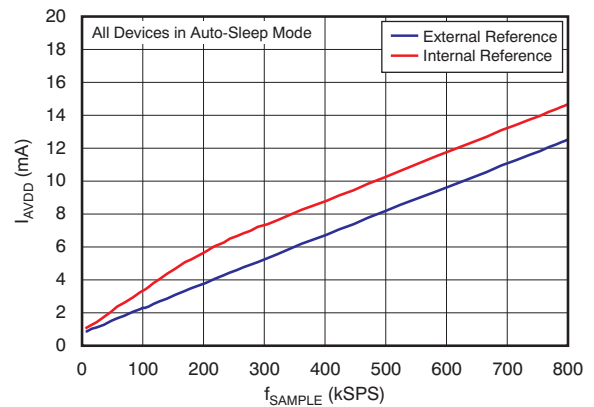

Figure 26.

THEORY OF OPERATION

GENERAL DESCRIPTION

The ADS8363/7263/7223 contain two 16-/14-/12-bit analog-to-digital converters (ADCs), respectively, that operate based on the successive approximation register (SAR) principle. These ADCs sample and convert simultaneously. Conversion time can be as low as 875ns. Adding an acquisition time of 100ns, and a margin of 25ns for propagation delay and CONVST pulse generation, results in a maximum conversion rate of 1MSPS.

Each ADC has a fully-differential 2:1 multiplexer front-end. In many common applications, all negative input signals remain at the same constant voltage (for example, 2.5V). For these applications, the multiplexer can be used in a pseudo-differential 4:1 mode, where the CMx pins function as common-mode pins and all four analog inputs are referred to the corresponding CMx pin.

The ADS8363/7263/7223 also include a 2.5V internal reference. This reference drives two independently-programmable, 10-bit digital-to-analog converters (DACs), allowing the voltage at each of the REFIOx pins to be adjusted through the internal REFDACx registers in 2.44mV steps. A low-noise, unity-gain operational amplifier buffers each of the DAC outputs and drives the REFIOx pin.

The ADS8363/7263/7223 provide a serial interface that is compatible with the ADS8361. However, instead of the ADS8361 A0 pin that controls the channel selection, the ADS8363/7263/7223 offers a serial data input (SDI) pin that supports additional functions described in the *Digital* section of this data sheet (also see the *ADS8361 Compatibility* section).

ANALOG

This section discusses the analog input circuit, the ADCs, and the reference design of the device.

Analog Inputs

Each ADC is fed by an input multiplexer, as shown in Figure 27. Each multiplexer is used in either a fully-differential 2:1 configuration (as shown in Table 1) or a pseudo-differential 4:1 configuration (as shown in Table 2).

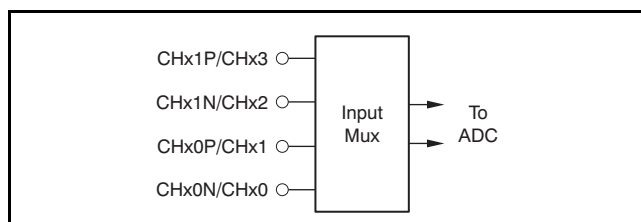

Figure 27. Input Multiplexer Configuration

Channel selection is performed using either the external M0 pin or the C[1:0] bits in the Configuration (CONFIG) register in fully-differential mode, or using the SEQFIFO register in pseudo-differential mode. In either case, changing the multiplexer settings impacts the conversion started with the next CONVST pulse.

Table 1. Fully-Differential 2:1 Multiplexer Configuration

C1	C0	ADC+	ADC-
0	x	CHx0P	CHx0N
1	x	CHx1P	CHx1N

Table 2. Pseudo-Differential 4:1 Multiplexer Configuration

C1	C0	ADC+	ADC-
0	0	CHx0	CMx/REFIOx
0	1	CHx1	CMx/REFIOx
1	0	CHx2	CMx/REFIOx
1	1	CHx3	CMx/REFIOx

The input path for the converter is fully differential and provides a good common-mode rejection of 92dB at 100kHz (for the ADS8363). The high CMRR also helps suppress noise in harsh industrial environments.

Each of the 40pF sample-and-hold capacitors (shown as C_S in Figure 28) is connected through switches to the multiplexer output. Opening the switches holds the sampled data during the conversion process. After the conversion completes, both capacitors are precharged for the duration of one clock cycle to the voltage present at the REFIOx pin. After precharging, the multiplexer outputs are connected to the sampling capacitors again. The voltage at the analog input pin is usually different from the reference voltage; therefore, the sample capacitors must be charged to within one-half LSB for 16-, 14-, or 12-bit accuracy during the acquisition time t_{ACQ} (see the *Timing Diagrams*).

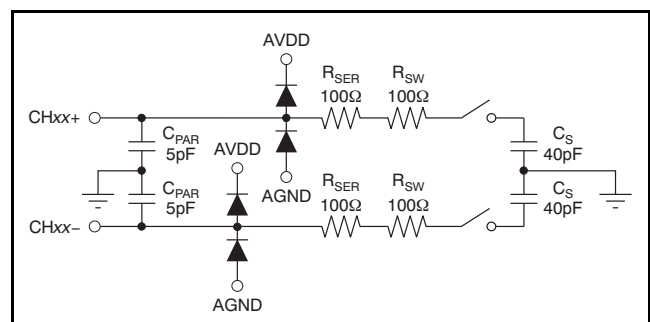

Figure 28. Equivalent Analog Input Circuit

Acquisition is indicated with the BUSY signal being low. It starts by closing the input switches (after finishing the previous conversion and precharging) and finishes with the rising edge of the CONVST signal. If the device operates at full speed, the acquisition time is typically 100ns.

The minimum –3dB bandwidth of the driving operational amplifier can be calculated as shown in [Equation 1](#), with $n = 16$ for the resolution of the ADS8363, $n = 14$ for the ADS7263, or $n = 12$ for the ADS7223:

$$f_{-3dB} = \frac{\ln(2)(n + 1)}{2\pi t_{ACQ}} \quad (1)$$

With $t_{ACQ} = 100\text{ns}$, the minimum bandwidth of the driving amplifier is 19MHz for the ADS8363, 17MHz for the ADS7263, and 15MHz for the ADS7223. The required bandwidth can be lower if the application allows a longer acquisition time.

A gain error occurs if a given application does not fulfill the settling requirement shown in [Equation 1](#). However, linearity and THD are not directly affected as a result of precharging the capacitors.

The [OPA365](#) from Texas Instruments is recommended as a driver; in addition to offering the required bandwidth, it also provides a low offset and excellent THD performance (see also [Application Information](#) section).

The phase margin of the driving operational amplifier is usually reduced by the ADC sampling capacitor. A resistor placed between the capacitor and the amplifier limits this effect; therefore, an internal 100Ω resistor (R_{SER}) is placed in series with the switch. The switch resistance (R_{SW}) is typically 100Ω, as shown in [Figure 28](#).

An input driver may not be required, if the impedance of the signal source (R_{SOURCE}) fulfills the requirement of [Equation 2](#):

$$R_{SOURCE} < \frac{t_{ACQ}}{C_S \ln(2)(n + 1)} - (R_{SER} + R_{SW})$$

Where:

$n = 16/14/12$ for the resolution of the ADS8363/7263/7223, respectively.

$C_S = 40\text{pF}$ sample capacitance.

$R_{SER} = 100\Omega$ input resistor value.

$R_{SW} = 100\Omega$ switch resistance value. (2)

With $t_{ACQ} = 100\text{ns}$, the maximum source impedance should be less than 12Ω for the ADS8363, less than 40Ω for the ADS7263, and less than 77Ω for the ADS7223. The source impedance can be higher if the ADC is used at a lower data rate.

The differential input voltage range of the ADC is $\pm V_{REF}$, the voltage at the selected REFIOx pin.

It is important to keep the voltage to all inputs within the 0.3V limit below AGND and above AVDD, while not allowing dc current to flow through the inputs (exceeding these limits causes the internal ESD diodes to conduct, leading to increased leakage current that may damage the device). Current is only necessary to recharge the sample-and-hold capacitors.

Unused inputs should be directly tied to AGND or RGND without the need of a pull-down resistor.

Analog-to-Digital Converters (ADCs)

The ADS8363/7263/7223 include two SAR-type, 1MSPS, 16-/14-/12-bit ADCs that include sample-and-hold (S&H), respectively, as shown in the [Functional Block Diagram](#) on the front page of this data sheet.

CONVST

The analog inputs are held with the rising edge of the CONVST (conversion start) signal. The setup time of CONVST referred to the next rising edge of CLOCK (system clock) is 12ns (minimum). The conversion automatically starts with the rising CLOCK edge. A rising edge of CONVST should not be issued during a conversion (that is, when BUSY is high).

RD (read data) and CONVST can be shorted to minimize necessary software and wiring. The RD signal is triggered by the device on the falling edge of CLOCK. Therefore, the combined signals must be activated with the rising CLOCK edge. The conversion then starts with the subsequent rising CLOCK edge. In modes with only SDOA active (that is, in modes II, IV, SII, and SIV), the maximum length of the combined RD and CONVST signal is one clock cycle if the half-clock timing is used.

If CONVST and RD are combined, \overline{CS} must be low whenever a new conversion starts; however, this condition is not required if RD and CONVST are controlled separately. Note that if FIFO is used, CONVST must be controlled separately from RD.

After completing a conversion, the sample capacitors are automatically precharged to the value of the reference voltage used to significantly reduce the crosstalk among the multiplexed input channels.

CLOCK

The ADS8363/7263/7223 use an external clock with an allowable frequency range that depends on the mode being used. By default (after power-up), the ADC operates in half-clock mode, which supports a clock in the range of 0.5MHz to 20MHz. In full-clock mode, the ADC requires a clock in the range of 1MHz to 40MHz. For maximum data throughput, the clock

signal should be continuously running. However, in applications that use the device in burst mode, the clock may be held static low or high upon completion of the read access and before starting a new conversion.

The CLOCK duty cycle should be 50%. However, the device functions properly with a duty cycle between 30% and 70%.

RESET

The ADS8363/7263/7223 feature an internal power-on reset (POR) function. A user-controlled reset can also be issued using SDI register bits A[3:0] (see the [Digital](#) section).

REFIOx

The ADS8363/7263/7223 include a low-drift, 2.5V internal reference source. This source feeds two, 10-bit string DACs that are controlled through registers. As a result of this architecture, the reference voltages at REFIOx are programmable in 2.44mV steps and can be adjusted to the application requirements without the use of additional external components. The actual output voltage can be calculated using [Equation 3](#), with code being the decimal value of the REFDACx register content:

$$V_{REF} = \frac{2.5V(\text{code} + 1)}{1024} \quad (3)$$

The reference DAC has a fixed transition at the code 508 (0x1FC). At this code, the DAC may show a jump of up to 10mV in its transfer function. [Table 3](#) lists some examples of internal reference DAC settings. However, to ensure proper performance, the REFDACx output voltage should not be programmed below 0.5V.

Table 3. REFDACx Setting Examples

VREFOUT (NOM)	DECIMAL CODE	BINARY CODE	HEXADECIMAL CODE
0.5000V	205	00 1100 1101	0CD
1.2429V	507	01 1111 1100	1FB
1.2427V	508	01 1111 1101	1FC
2.5000V	1023	11 1111 1111	3FF

A minimum of 22µF capacitance is required on each REFIOx output to keep the references stable. The settling time is 8ms (maximum) with the reference

capacitor connected. Smaller reference capacitance values reduce the DNL, INL, and ac performance of the device. By default, both reference outputs are disabled and the respective values are set to 2.5V after power-up.

For applications that use an external reference source, the internal reference can be disabled (default) using the RPD bit in the CONFIG register (see the [Digital](#) section). The REFIOx pins are directly connected to the ADC; therefore, the internal switching generates spikes that can be observed at this pin. Therefore, also in this case, an external 22µF capacitor to the analog ground (AGND) should be used to stabilize the reference input voltage.

Disabled REFIOx pins can be left floating or can be directly tied to AGND or RGND.

Each of the reference DAC outputs can be individually selected as a source for each channel input using the Rxx bits in the REFCM register. [Figure 29](#) illustrates a simplified block diagram of the internal circuit.

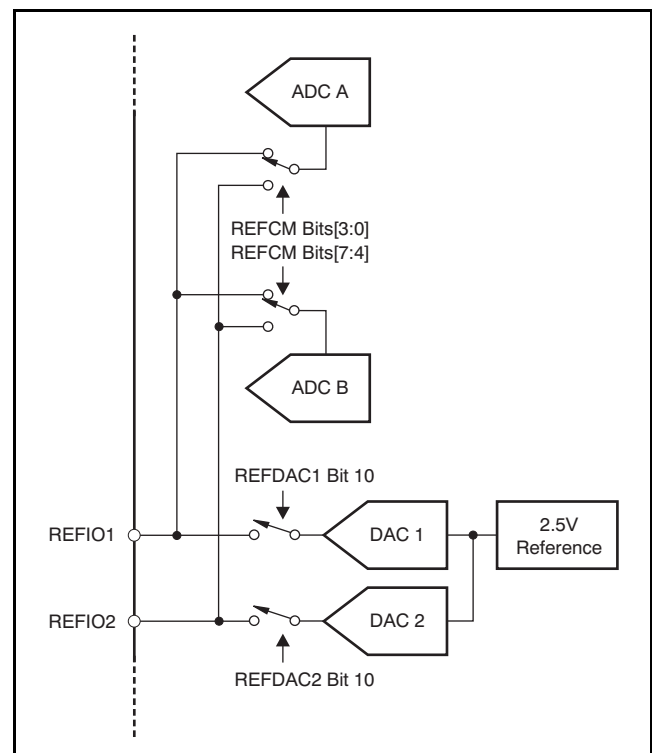

Figure 29. Reference Selection Circuit

DIGITAL

This section reviews the timing and control of the serial interface.

The ADS8363/7263/7223 offer a set of internal registers (see the [Register Map](#) section for details), which allows the control of several features and modes of the device, as [Table 5](#) shows.

Mode Selection Pin M0 and M1

The ADS8363/7263/7223 can be configured to four different operating modes by using mode pins M0 and M1, as shown in [Table 4](#).

Table 4. M0/M1 Truth Table

M0	M1	CHANNEL SELECTION	SDO _x USED
0	0	Manual (through SDI)	SDOA and SDOB
0	1	Manual (through SDI)	SDOA only
1	0	Automatic	SDOA and SDOB
1	1	Automatic	SDOA only

The M0 pin sets either manual or automatic channel selection. In Manual mode, CONFIG register bits C[1:0] are used to select between channels CH_x0 and CH_x1. In Automatic mode, CONFIG register bits C[1:0] are ignored and channel selection is controlled by the device after each conversion. The automatic channel selection is only performed on fully-differential inputs in this case; for pseudo-differential inputs, the internal sequencer controls the input multiplexer.

The M1 pin selects between serial data being transmitted simultaneously on both SDOA and SDOB outputs for each channel, respectively, or using only the SDOA output for transmitting data from both channels (see [Figure 34](#) through [Figure 39](#) and the associated text for more information).

Additionally, the SDI pin is used for controlling device functionality through the internal register; see the [Register Map](#) section for details.

Half-Clock Mode (default mode after power-up and reset)

The ADS8363/7263/7223 power up in half-clock mode, in which the ADC requires at least 20 CLOCKS for a complete conversion cycle, including the acquisition phase. The conversion result can only be read during the next conversion cycle. The first output bit is available with the falling RD edge, while the following output data bits are refreshed with the rising edge of CLOCK.

Full-Clock Mode (allowing conversion and data readout within 1 μ s, supported in dual output modes)

The full-clock mode allows converting data and reading the result within 1 μ s. The entire cycle requires 40 CLOCKS. The first output bit is available with the falling RD edge while the following output data bits are refreshed with the falling edge of the CLOCK in this mode.

The full-clock mode can only be used with analog power supply AVDD in the range of 4.5V to 5.5V and digital supply DVDD in the range of 2.3V to 3.6V. The internal FIFO is disabled in full-clock mode.

2-Bit Counter

These devices offers a selectable 2-bit counter (activated using the CE bit in the CONFIG register) that is a useful feature in safety applications. The counter value automatically increments whenever a new conversion result is stored in the output register, indicating a new value. The counter default value after power-up is '01' (followed by '10', '11', '00', '01', and so on), as shown in [Figure 31](#). Because the counter value increments only when a new conversion results are transferred to the output register, this counter is used to verify that the ADC has performed a conversion and the data read is the result of this new conversion (not a old result read multiple times).

Table 5. Supported Operating Modes

INPUT SIGNAL TYPE	MANUAL CHANNEL SELECTION	AUTOMATIC CHANNEL SELECTION
Fully-differential (PDE bit = '0')	Operating modes: I, II, and special mode II Channel information selectable through CID bit FIFO: not available	Operating modes: III, IV and special mode IV Channel information selectable through CID bit FIFO: available in mode III and special mode IV; when used, a single read pulse allows reading of all data
Pseudo-differential (PDE bit = '1')	Operating modes: I, II and special mode II Channel information selectable through CID bit FIFO: not available	Operating modes: III and special mode IV Channel information not available (CID bit forced to '1') FIFO: available in mode III and special mode IV; when used, a single read pulse allows reading of all data Pseudo-differential sequencer is enabled

REGISTERS

Register Map

ADS8363/7263/7223 operation is controlled through a set of registers described in the following sections. [Table 6](#) shows the register map. The contents of these 16-bit registers can be set using the serial data input (SDI) pin, which is coupled to RD and clocked into the device on each falling edge of CLOCK. All data must be transferred MSB first. All register updates become active with the rising edge of CLOCK after completing the 16-clock-cycle write access operation.

Table 6. Register Map

REGISTER	BIT 15	BIT 14	BIT 13	BIT 12	BIT 11	BIT 10	BIT 9	BIT 8	BIT 7	BIT 6	BIT 5	BIT 4	BIT 3	BIT 2	BIT 1	BIT 0
CONFIG	C1	C0	R1	R0	PD1	PD0	FE	SR	FC	PDE	CID	CE	A3	A2	A1	A0
REFDAC1	0	0	0	0	0	RPD	D9	D8	D7	D6	D5	D4	D3	D2	D1	D0
REFDAC2	0	0	0	0	0	RPD	D9	D8	D7	D6	D5	D4	D3	D2	D1	D0
SEQFIFO	S1	S0	SL1	SL0	C11	C10	C21	C20	C31	C30	C41	C40	SP1	SP0	FD1	FD0
REFCM	CMB3	CMB2	CMB1	CMB0	CMA3	CMA2	CMA1	CMA0	RB3	RB2	RB1	RB0	RA3	RA2	RA1	RA0

To update the CONFIG register, a single write access is required. To update the contents of all the other registers, a write access to the control register with the appropriate register address (bits A[3:0]), followed by a write access to the actual register is required (refer to [Figure 30](#)). It is possible to update the CONFIG register contents while issuing a register read out access with a single register write access. For example, it is possible to change the mode of the device to full-clock mode while activating the REFDAC1 register read access; because full-clock mode is active upon the 16th clock cycle of the CONFIG register update, the REFDAC1 data are then presented according to the full-clock mode timing.

To verify the register contents, a read access may be issued using CONFIG register bits A[3:0]. Such access is described in the [Programming the Reference DAC](#) section, based on an example of verifying the reference DAC register settings. The register contents are always available on SDOA with the next read command. For example, if the FIFO is used, the register contents are presented after completion of the FIFO read access (see [Table 10](#) for more details). In both cases, a complete read or write access requires a total of 40 clock cycles, during which a new access to the CONFIG register is not allowed.

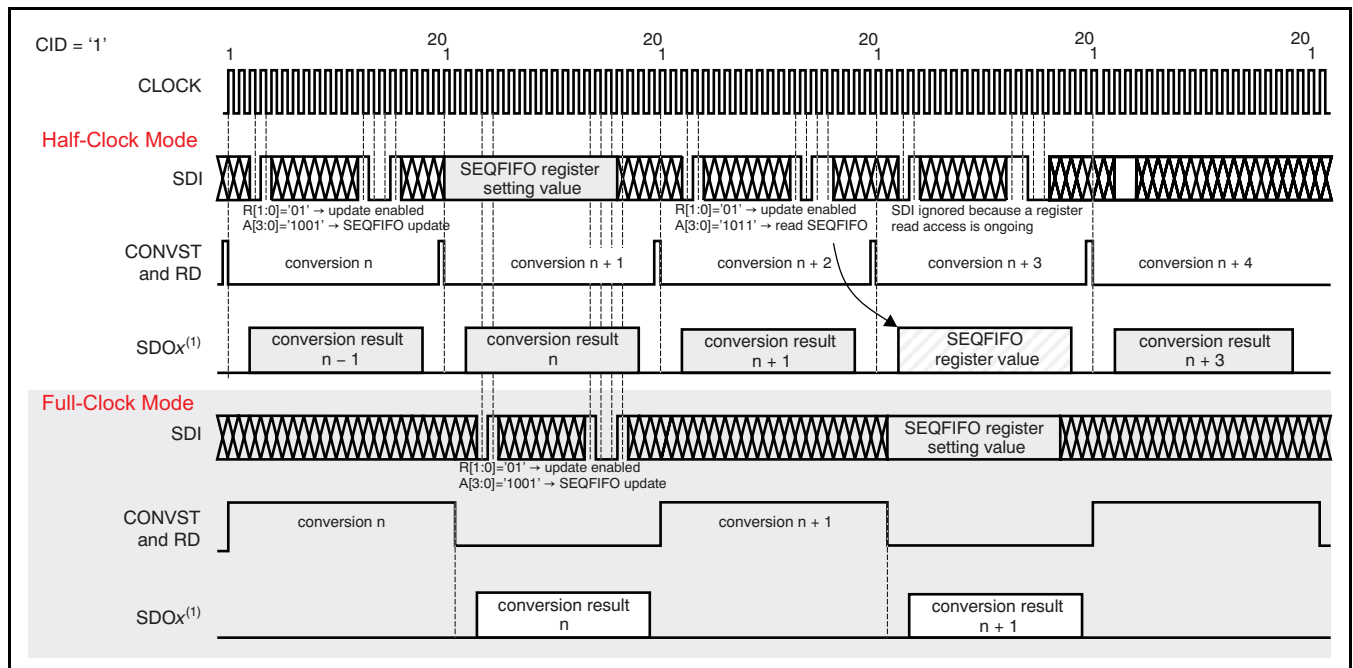

(1) ADS7263/7223 output data with the MSB located as ADS8363 and the last 2/4 bits being '0'.

**Figure 30. Updating Internal Register Settings
 (Example: Half-Clock Mode, CID = '1')**

Configuration (CONFIG) Register

The configuration register selects the input channel, the activation of power-down modes, and the access to the sequencer/FIFO, reference selection, and reference DAC registers.

Table 7. CONFIG: Configuration Register (default = 0000h)

MSB															
BIT 15	BIT 14	BIT 13	BIT 12	BIT 11	BIT 10	BIT 9	BIT 8	BIT 7	BIT 6	BIT 5	BIT 4	BIT 3	BIT 2	BIT 1	BIT 0
C1	C0	R1	R0	PD1	PD0	FE	SR	FC	PDE	CID	CE	A3	A2	A1	A0

- Bits[15:14] C[1:0]—Input Channel Selection (ADS8361-compatible).**
These bits control the multiplexer input selection depending on the status of the PDE bit.
If PDE = '0' (default), the multiplexer is in fully-differential mode and bits C[1:0] control the input multiplexer in the following manner:
0x = conversion of analog signals at inputs CHx0P/CHx0N (default).
1x = conversion of analog signals at inputs CHx1P/CHx1N.
If PDE = '1', the multiplexer is in pseudo-differential mode and bits C[1:0] control the input multiplexer in the following manner:
00 = conversion of analog signal at input CHx0 versus the selected CMx or REFIOx (default).
01 = conversion of analog signal at input CHx1 versus the selected CMx or REFIOx.
10 = conversion of analog signal at input CHx2 versus the selected CMx or REFIOx.
11 = conversion of analog signal at input CHx3 versus the selected CMx or REFIOx.
- Bits[13:12] R[1:0]—Configuration register update control.**
These bits control the access to the CONFIG register.
00 = If M0 = '0', update of input selection bits C[1:0] only (ADS8361-compatible behavior); if M0 = '1', no action (default).
01 = Update of the entire CONFIG register content enabled.
10 = Reserved for factory test; do not use. Changes may result in false behavior of the device.
11 = If M0 = '0', update of input selection bits C[1:0] only (ADS8361-compatible behavior); if M0 = '1', no action.
- Bits[11:10] PD[1:0]—Power-down control.**
These bits control the different power-down modes of the device.
00 = Normal operation (default).
01 = Device is in power-down mode (see the [Power-Down Modes and Reset](#) section for details).
10 = Device is in sleep power-down mode (see the [Power-Down Modes and Reset](#) section for details).
11 = Device is in Auto-sleep power-down mode (see the [Power-Down Modes and Reset](#) section for details).
- Bit 9 FE—FIFO enable control.**
0 = The internal FIFO is disabled (default).
1 = The internal FIFO is enabled. The depth of the FIFO is controlled by SEQFIFO register bits FD[1:0].
- Bit 8 SR—Special read mode control.**
0 = Special read mode is disabled (default).
1 = Special read mode is enabled; see [Figure 36](#) and [Figure 39](#) for details.
- Bit 7 FC—Full clock mode operation control.**
0 = Full-clock mode operation is disabled (default); see [Figure 1](#) for details.
1 = Full-clock mode operation is enabled; see [Figure 2](#) for details.
- Bit 6 PDE—Pseudo-differential mode operation enable.**
0 = 2 x 2 fully-differential operation (default).
1 = 4 x 2 pseudo-differential operation.
- Bit 5 CID—Channel information disable.**
0 = The channel information followed by conversion results or register contents are present on SDOx (default).
1 = Conversion data or register content is present on SDOx immediately after the falling edge of RD.
- Bit 4 CE—2-bit counter enable (see [Figure 31](#)).**
0: The internal counter is disabled (default).
1: The counter value is available prior to the conversion result on SDOx (active only if CID = '0').

Bits[3:0]

A[3:0]—Register access control.

These bits allow reading of the CONFIG register contents and control the access to the remaining registers of the device.

- x000 = Update CONFIG register contents only (default)
- 0001 = Read CONFIG register content on SDOA with next access (see Figure 30).
- x010 = Write to REFDAC1 register with next access (see Figure 30).
- 0011 = Read REFDAC1 register content on SDOA with next access (see Figure 30).
- 0100 = Generate software reset of the device.
- x101 = Write to REFDAC2 register with next access (see Figure 30).
- 0110 = Read REFDAC2 register content on SDOA with next access (see Figure 30).
- x111 = Update CONFIG register contents only.
- 1001 = Write to SEQFIFO register with next access (see Figure 30).
- 1011 = Read SEQFIFO register content on SDOA with next access (see Figure 30).
- 1100 = Write to REFCM register with next access (see Figure 30).
- 1110 = Read REFCM register content on SDOA with next access (see Figure 30).

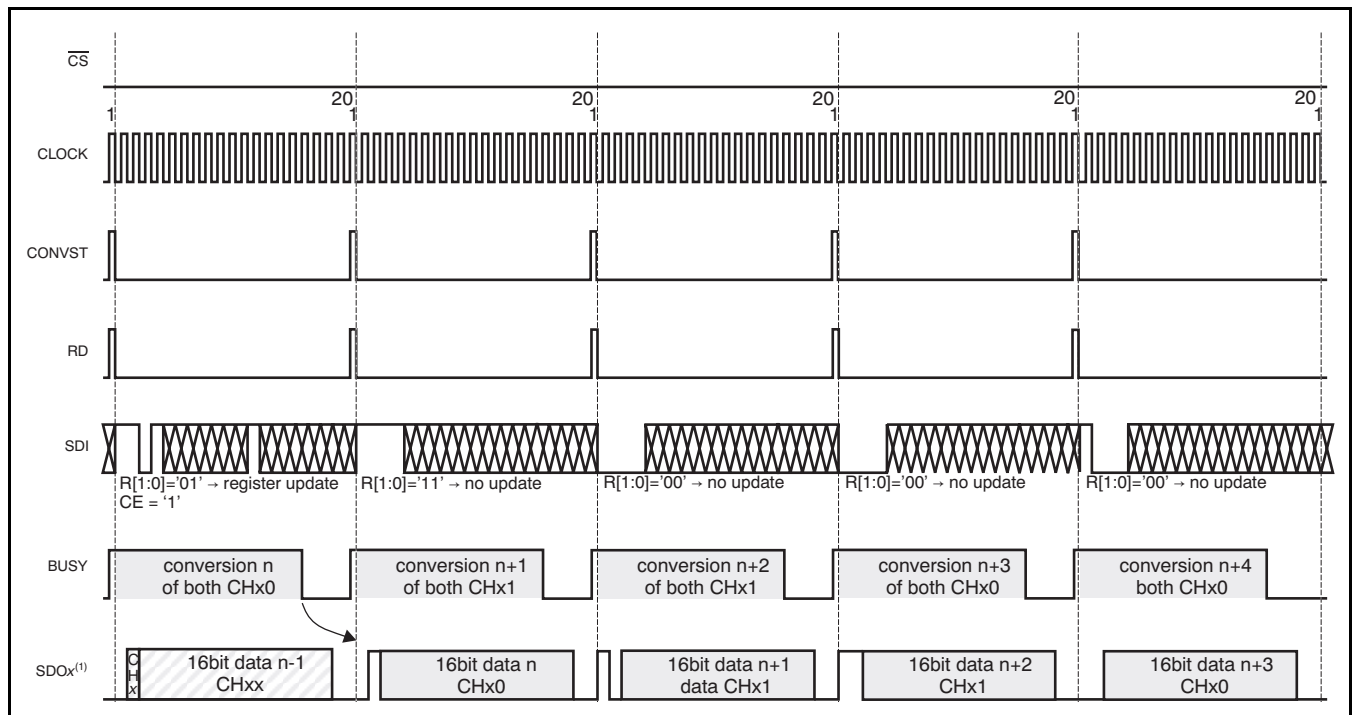

(1) ADS7263/7223 output data with the MSB located as ADS8363 and the last 2/4 bits being '0'.

**Figure 31. 2-Bit Counter Feature
 (Half-Clock Mode, Manual Channel Control, CID = '0')**

REFDAC1 and REFDAC2 Registers

Two reference DAC registers allow for enabling and setting up the appropriate value for each of the output string DACs that are connected to the REFIO1 and REFIO2 pins.

Table 8. REFDAC1 Control Register (default = 07FFh)

MSB															LSB
BIT 15	BIT 14	BIT 13	BIT 12	BIT 11	BIT 10	BIT 9	BIT 8	BIT 7	BIT 6	BIT 5	BIT 4	BIT 3	BIT 2	BIT 1	BIT 0
0	0	0	0	0	RPD	D9	D8	D7	D6	D5	D4	D3	D2	D1	D0

Bits[15:11] **Not used; always set to '0'.**

Bit 10 RPD—DAC1 power down.

0 = Internal reference path 1 is enabled and the reference voltage is available at the REFIO1 pin.
1 = The internal reference path is disabled (default).

Bits[9:0] **D[9:0]—DAC1 setting bits.**

These bits correspond to the settings of the internal reference DACs (compare REFIO section). The D9 bit is the MSB value of the DAC.
Default value is 1FFh (2.5V nom)

Table 9. REFDAC2 Control Register (default = 07FFh)

MSB															LSB
BIT 15	BIT 14	BIT 13	BIT 12	BIT 11	BIT 10	BIT 9	BIT 8	BIT 7	BIT 6	BIT 5	BIT 4	BIT 3	BIT 2	BIT 1	BIT 0
0	0	0	0	0	RPD	D9	D8	D7	D6	D5	D4	D3	D2	D1	D0

Bits[15:11] **Not used; always set to '0'.**

Bit 10 RPD—DAC2 power down.

0 = Internal reference path 2 is enabled and the reference voltage is available at the REFIO2 pin.
1 = The internal reference path is disabled (default).

Bits[9:0] **D[9:0]—DAC2 setting bits.**

These bits correspond to the settings of the internal reference DACs (compare REFIO section). The D9 bit is the MSB value of the DAC.
Default value is 1FFh (2.5V nom)

Sequencer/FIFO (SEQFIFO) Register

The ADS8363/7363/7223 feature a programmable sequencer that controls the switching of the ADC input multiplexer in pseudo-differential, automatic channel-selection mode only. When used, a single read pulse allows reading of all stored conversion data. A single CONVST is required to control the conversion of the entire sequence. If the sequencer is used, CONVST and RD must be controlled independently (see [Figure 32](#) and [Figure 33](#)).

Additionally, a programmable FIFO is available on each channel that allows for storing up to four conversion results. Both features are controlled using this register. If FIFO is used, CONVST and RD must be controlled independently. Note that after activation of this feature, the FIFO should be full before being read for the first time.

If the FIFO is full and a new conversion starts, the contents are shifted by one while the oldest result is lost. Only when the sequencer is used are the entire FIFO contents lost (that is, all bits are automatically set to '0'). The FIFO can be used independently from the sequencer. When both are used, the complete sequence must be finished before reading the data out of the FIFO; otherwise, the data may be corrupted.

[Table 10](#) contains details of the data readout requirements depending on the FIFO settings in automatic channel selection mode.

Table 10. Conversion Result Read Out in FIFO Mode

AUTOMATIC CHANNEL SELECTION		
INPUT SIGNAL TYPE	FE = '0'	FE = '1'
Fully-differential input mode	Read cycle length = 1 word One RD pulse required after each conversion	Read cycle length = 2 · FIFO length One RD pulse required for the entire FIFO content
Pseudo-differential input mode	Read cycle length = 1 word One RD pulse required after each conversion or after completing the sequence if S1 = '1' and S0 = '1'	Read cycle length = 2 · sequencer length · FIFO length One RD pulse required for the entire FIFO content

Table 11. SEQFIFO: Sequencer and FIFO Register (default = 0000h)⁽¹⁾

MSB															LSB	
BIT 15	BIT 14	BIT 13	BIT 12	BIT 11	BIT 10	BIT 9	BIT 8	BIT 7	BIT 6	BIT 5	BIT 4	BIT 3	BIT 2	BIT 1	BIT 0	
S1	S0	SL1	SL0	C11	C10	C21	C20	C31	C30	C41	C40	SP1	SP0	FD1	FD0	

(1) The sequencer is used in pseudo-differential mode only; this register should be set before setting the REFCM register.

- Bits[15:14]** **S[1:0]—Sequencer mode selection (see [Figure 32](#)) in pseudo-differential mode only.**
These bits allow for the control of the number of CONVSTs required, and the behavior of the BUSY pin in Sequencer mode.

0x = An individual CONVST is required with BUSY indicating each conversion (default).
10 = A single CONVST is required for the entire sequence with BUSY indicating each conversion (half-clock mode only).
11 = A single CONVST is required for the entire sequence with BUSY remaining high throughout the sequence (half-clock mode only).
- Bits[13:12]** **SL[1:0] Sequencer length control.**
These bits control the length of a sequence. Bits [11:6] are only active if SL > '00'.

00 = Do not use; use Mode I or II instead, where M0 = '0' (default).
01 = Sequencer length = 2; C1x (bits[11:10]) and C2x (bits[9:8]) define the actual channel selection.
10 = Sequencer length = 3; C1x (bits[11:10]), C2x (bits[9:8]) and C3x (bits[7:6]) define the actual channel selection.
11 = Sequencer length = 4; C1x (bits[11:10]), C2x (bits[9:8]), C3x (bits[7:6]), and C4x (bits[5:4]) define the actual channel selection.
- Bits[11:10]** **C1[1:0]—First channel in sequence selection bits.**
- Bits[9:8]** **C2[1:0]—Second channel in sequence selection bits.**
- Bits[7:6]** **C3[1:0]—Third channel in sequence selection bits.**
- Bits[5:4]** **C4[1:0]—Fourth channel in sequence selection bits.**

Bits [11:4] control the pseudo-differential input multiplexer channel selection in sequencer mode.

00 = CHA0 and CHB0 are selected for the next conversion (default).
01 = CHA1 and CHB1 are selected for the next conversion.
10 = CHA2 and CHB2 are selected for the next conversion.
11 = CHA3 and CHB3 are selected for the next conversion.

Bits[3:2]

SP[1:0]—Sequence position bits (read only).

These bits indicate the setting of the pseudo-differential input multiplexer in sequencer mode.

00 = Inputs selected using bits C1[1:0] are converted with next rising edge of CONVST (default).

01 = Inputs selected using bits C2[1:0] are converted with next rising edge of CONVST.

10 = Inputs selected using bits C3[1:0] are converted with next rising edge of CONVST.

11 = Inputs selected using bits C4[1:0] are converted with next rising edge of CONVST.

Bits [1:0]

FD[1:0]—FIFO depth control (see Figure 33).

These bits control the depth of the internal FIFO if CONFIG register bit FE = '1'.

00 = One conversion result per channel is stored in the FIFO for burst read access (default).

01 = Two conversion results per channel are stored in the FIFO for burst read access.

10 = Three conversion results per channel are stored in the FIFO for burst read access.

11 = Four conversion results per channel are stored in the FIFO for burst read access .

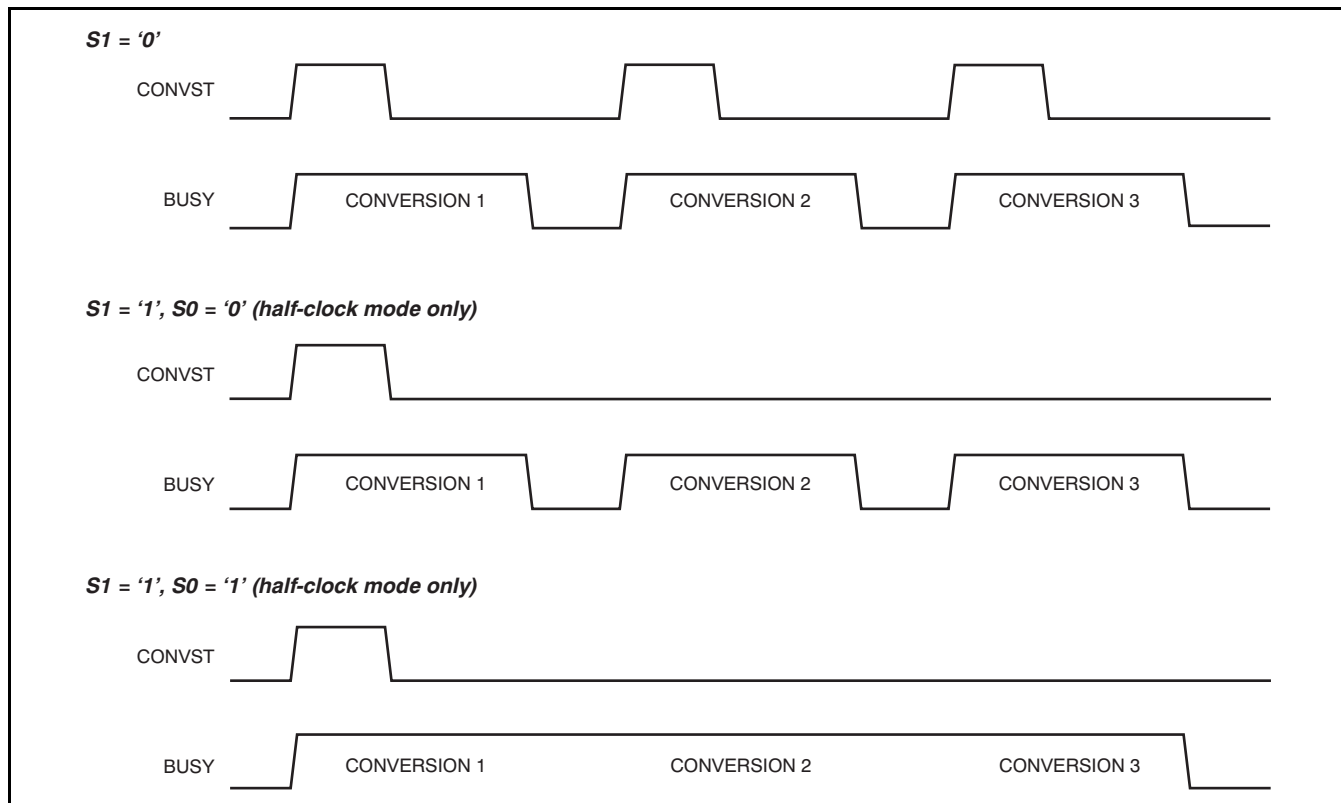

Figure 32. Sequencer Modes

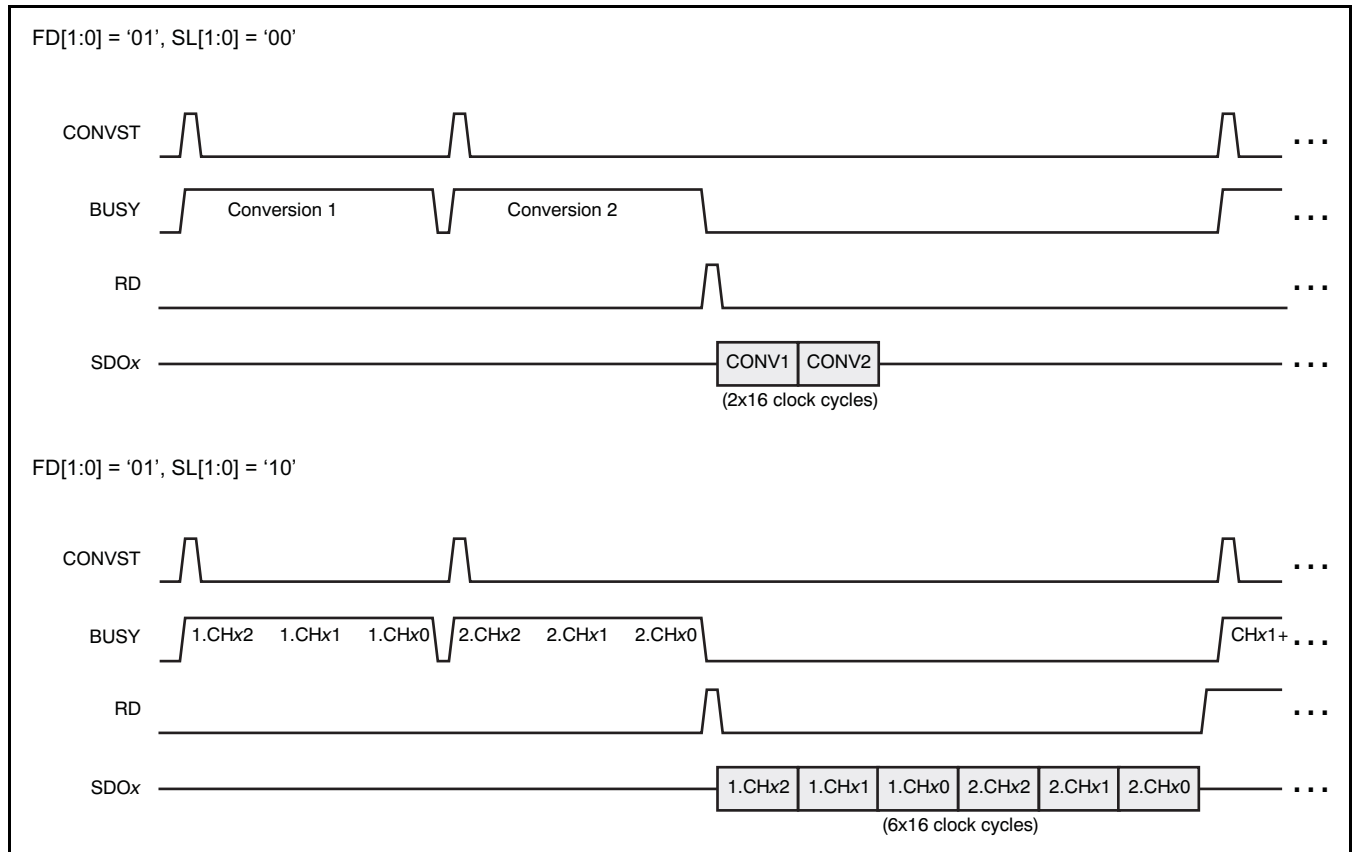

Figure 33. FIFO and Sequencer Operation Example

Reference and Common-Mode Selection (REFCM) Register

To allow flexible adjustment of the common-mode voltage in pseudo-differential mode while simplifying the circuit layout, the ADS8363/7263/7223 provide this register to assign one of the CMx inputs as a reference for each of the input signals. According to the register settings, the CMx signals are internally connected to the appropriate negative input of each ADC.

Additionally, this register also allows for the flexible assignment of one of the internal reference DAC outputs as a reference for each channel in both fully- and pseudo-differential modes.

Table 12. REFCM: Reference and Common-Mode Selection Register (default = 0000h)⁽¹⁾

MSB														LSB	
BIT 15	BIT 14	BIT 13	BIT 12	BIT 11	BIT 10	BIT 9	BIT 8	BIT 7	BIT 6	BIT 5	BIT 4	BIT 3	BIT 2	BIT 1	BIT 0
CMB3	CMB2	CMB1	CMB0	CMA3	CMA2	CMA1	CMA0	RB3	RB2	RB1	RB0	RA3	RA2	RA1	RA0

(1) This register should be set after setting the SEQFIFO register.

Bits[15:8]	CMxx—Common-mode source selection bits (per input channel). These bits allow selection of the CMx input pins or the internal reference source as common-mode for pseudo-differential inputs B[3:0] and A[3:0]. The selected signal is connected to the negative input of the corresponding ADC. 0 = external common-mode source through CMx (default). 1 = internal common-mode source = REFIOx, depending on settings of bits Rx[3 :0].
Bit 7	RB3—Internal reference DAC output selection for CHB3 in pseudo-differential mode, or channel CHB1P/N in fully-differential mode. 0 = internal reference source REFIO1 selected (default). 1 = internal reference source REFIO2 selected.
Bit 6	RB2—Internal reference DAC output selection for CHB2 in pseudo-differential mode only. 0 = internal reference source REFIO1 selected (default). 1 = internal reference source REFIO2 selected.
Bit 5	RB1—Internal reference DAC output selection for CHB1 in pseudo-differential mode only. 0 = internal reference source REFIO1 selected (default). 1 = internal reference source REFIO2 selected.
Bit 4	RB0—Internal reference DAC output selection for CHB0 in pseudo-differential mode, or channel CHB0P/N in fully-differential mode. 0 = internal reference source REFIO1 selected (default). 1 = internal reference source REFIO2 selected.
Bit 3	RA3—Internal reference DAC output selection for CHA3 in pseudo-differential mode, or channel CHA1P/N in fully-differential mode. 0 = internal reference source REFIO1 selected (default). 1 = internal reference source REFIO2 selected.
Bit 2	RA2—Internal reference DAC output selection for CHA2 in pseudo-differential mode only. 0 = internal reference source REFIO1 selected (default). 1 = internal reference source REFIO2 selected.
Bit 1	RA1—Internal reference DAC output selection for CHA1 in pseudo-differential mode only. 0 = internal reference source REFIO1 selected (default). 1 = internal reference source REFIO2 selected.
Bit 0	RA0—Internal reference DAC output selection for CHA0 in pseudo-differential mode, or channel CHA0P/N in fully-differential mode. 0 = internal reference source REFIO1 selected (default). 1 = internal reference source REFIO2 selected.

READ DATA INPUT (RD)

The RD input is used to control serial data outputs SDOx. The falling edge of the RD pulse triggers the output of the first bit of the output data. When CID = '0' this is the analog input channel indicator; when CID = '1', this is the MSB of the conversion result, or the 15th bit of the selected register, followed by output bits that are updated with the rising edge of the CLOCK in half-clock mode, or falling edge of the CLOCK in full-clock mode.

The RD input can be controlled separately or in combination with the CONVST input (see [Figure 43](#) for a detailed timing diagram of this case). If RD is controlled separately, it can be issued whenever a conversion process has been finished (that is, after the falling edge of BUSY). However, in order to achieve the maximum data rate, the conversion results must be read during an ongoing conversion. In this case, the RD pulse should not be issued between the 16th and 19th clock cycle in half-clock mode, or between the 34th and 36th clock cycle in full-clock mode, after starting the conversion.

If a read access is repeated without issuing a new conversion, the result of the last conversion is presented on the output(s) again. A repeated readout should only be performed when BUSY is low.

Note that in full-clock mode, only the first read access delivers the correct channel information (if CID = '0' in the CONFIG register), while the following readouts contain invalid channel details. The channel information is corrected with the next conversion.

Read access to verify the content of the internal registers is described in the [Register Map](#) section.

SERIAL DATA OUTPUTS (SDOx)

The following sections explain the different modes of operation in detail.

The digital output code format of the ADS8363/7263/7223 is binary twos complement, as shown in [Table 13](#).

Consider both detailed timing diagrams ([Figure 1](#) and [Figure 2](#)) shown in the [Timing Diagrams](#) section. For maximum data throughput, the description and diagrams given in this data sheet assume that the CONVST and RD pins are tied together; see [Figure 43](#) for timing details in this case. Note that these pins can also be controlled independently.

Table 13. Output Data Format

DESCRIPTION	DIFFERENTIAL INPUT VOLTAGE	INPUT VOLTAGE AT CHxxP (CHxxN = V _{REF} = 2.5V)	BINARY CODE	HEXADECIMAL CODE
Positive full-scale	V _{REF}	5V	ADS8363: 0111 1111 1111 1111	7FFF
			ADS7263: 0111 1111 1111 1100	7FFC
			ADS7223: 0111 1111 1111 0000	7FF0
Midscale	0V	2.5V	0000 0000 0000 0000	0000
Midscale – 1LSB	–V _{REF} /resolution	ADS8363: 2.499924V	ADS8363: 1111 1111 1111 1111	FFFF
		ADS7263: 2.499847V	ADS7263: 1111 1111 1111 1100	FFFC
		ADS7223: 2.499390V	ADS7223: 1111 1111 1111 0000	FFF0
Negative full-scale	–V _{REF}	0V	1000 0000 0000 0000	8000

Mode I

With the M0 and M1 pins both set to '0', the device enters manual channel-control operation and outputs data on both SDOA and SDOB, accordingly. The SDI pin can be used to switch between the channels, as explicitly shown in the corresponding timing diagrams. A conversion is initiated by bringing CONVST high.

With the rising edge of CONVST, the device switches asynchronously to the external CLOCK from sample to hold mode, and the BUSY output pin goes high and remains high for the duration of the conversion cycle. On the falling edge of the second CLOCK cycle, the device latches in the channel for the next conversion cycle, depending on the status of

CONFIG register bits C[1:0]. \overline{CS} must be brought low to enable both serial outputs. Data are valid on the falling edge of every 20 clock cycles per conversion. The first two bits are set to '0'. The subsequent data contain the 16-, 14-, or 12-bit conversion result (the most significant bit is transferred first), with trailing zeroes, as shown in Figure 34.

This mode can be used for fully- or pseudo-differential inputs; in both cases, channel information bits are '00' if CID = '0'. Note that FIFO is not available in this mode.

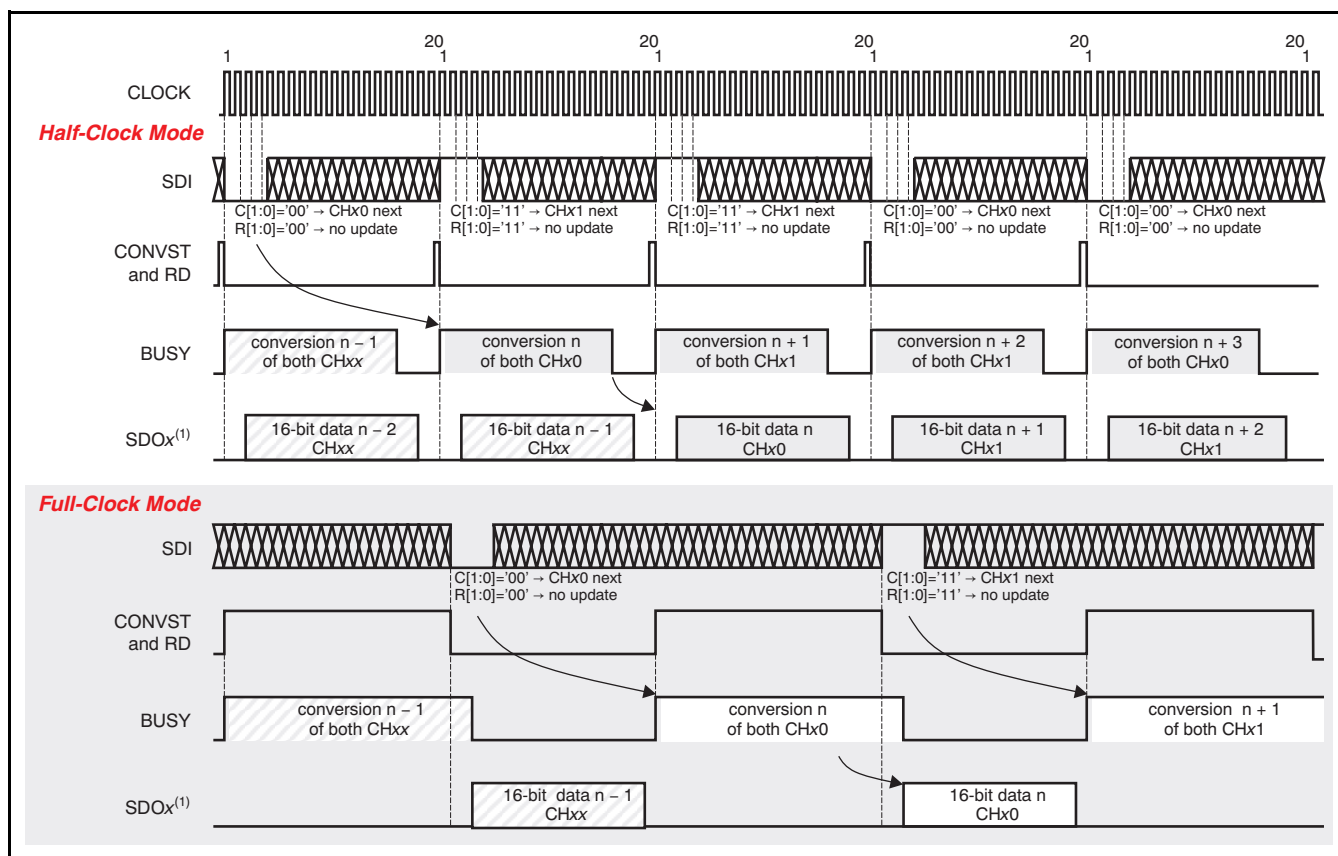

(1) ADS7263/7223 output data with the MSB located as ADS8363 and the last 2/4 bits being '0'.

Figure 34. Mode I Timing
(M0 = '0', M1 = '0', PDE = '0', CID = '1', Fully-Differential Example)

Mode II (Half-Clock Mode Only)

With M0 = '0' and M1 = '1', the ADS8363/7263/7223 also operate in manual channel-control mode and output data on the SDOA pin only while SDOB is set to high impedance. All other pins function in the same manner as they do in Mode I.

In half-clock mode, because it takes 40 clock cycles to output the results from both ADCs (instead of 20 cycles if M1 = '0'), the device requires 2.0µs to perform a complete read cycle. If the CONVST signal is issued every 1.0µs (required for the RD signal) as in Mode I, every second pulse is ignored, as shown in Figure 35. CONVST and RD signals must not be longer than one clock cycle to ensure proper functionality and avoid corruption of output data.

Full-clock mode is not supported in this operational mode.

The output data consist of a '0', followed by an ADC indicator ('0' for CHAx or '1' for CHBx), and then 16, 14, or 12 bits of conversion result along with any trailing zeroes.

This mode can be used for fully- or pseudo-differential inputs. Channel information is valid in fully-differential mode only if CID = '0' (it contains correct ADC information while the channel bit is invalid in pseudo-differential mode). Note that FIFO is not available in this mode.

Changes to register bits FE, SR, PDE, and CID are active with the start of the next conversion; this is with a delay of one read access.

The register settings should be updated using every other RD pulse, aligned either with the one starting the conversion or the one to read the conversion results of channel B, as shown in Figure 35.

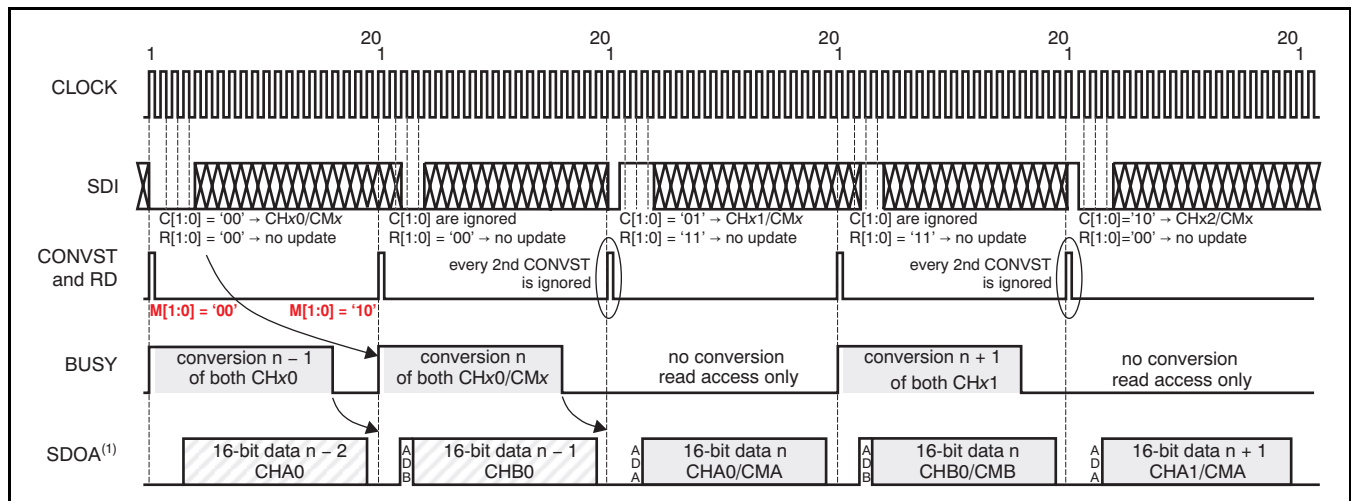

(1) ADS7263/7223 output data with the MSB located as ADS8363 and the last 2/4 bits being '0'.

Figure 35. Mode II Timing
 (M0 = '0', M1 = '1', PDE = '0', CID = '0', Pseudo-Differential Example)

Special Read Mode II (Half-Clock Mode Only)

For Mode II, a special read mode is available in the ADS8363/7263/7223 where both data results can be read out triggered by a single RD pulse (refer to Figure 36). To activate this mode, The SR bit in the CONFIG register must be set to '1' (see Table 6). The CONVST and RD pins can still be tied together but are issued every 40 CLOCK cycles instead of 20. Output data are presented on SDOA only while SDOB is held in 3-state.

The RD signal in this mode must not be longer than one clock cycle to avoid corruption of output data.

This special mode can be used for fully- or pseudo-differential inputs. Channel information is valid in fully-differential mode only if CID = '0' (it contains correct ADC information while the channel bit is invalid in pseudo-differential mode). Note that FIFO is not available in this mode.

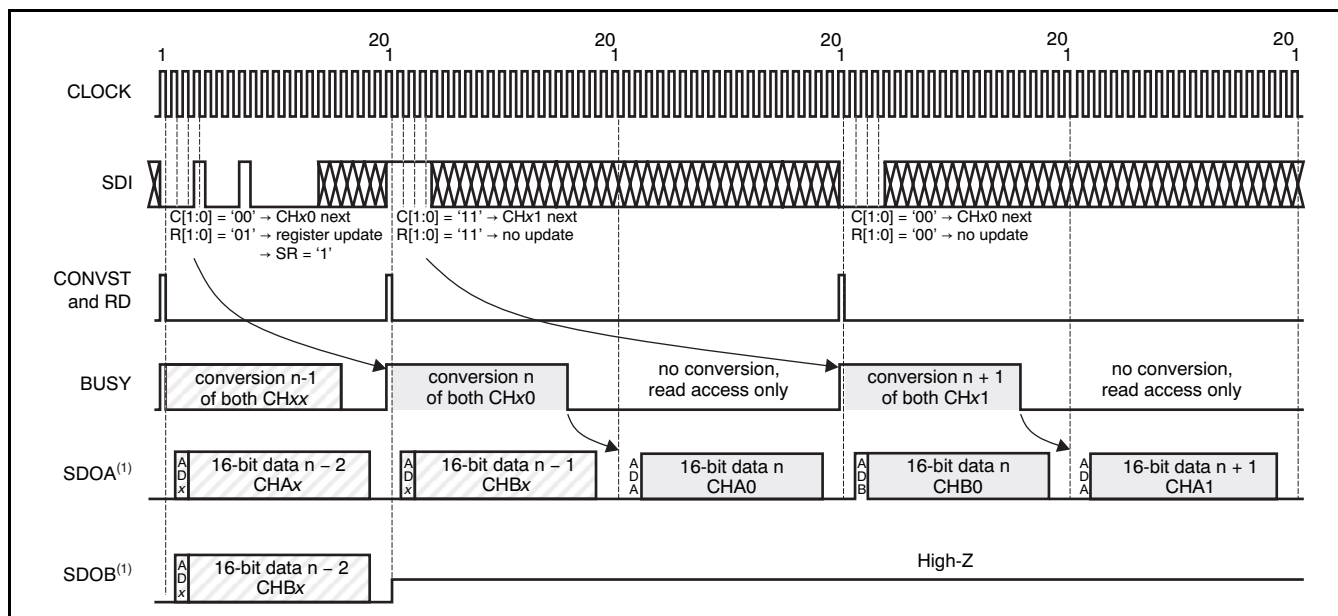

(1) ADS7263/7223 output data with the MSB located as ADS8363 and the last 2/4 bits being '0'.

Figure 36. Special Read Mode II Timing Diagram
(M0 = '0', M1 = '1', PDE = '0', SR = '1', CID = '0', Fully-Differential Example)

Mode III

With M0 = '1' and M1 = '0', the device automatically cycles between the differential inputs (CONFIG register bits C[1:0] are ignored) while offering the conversion result of CHAx on SDOA and the conversion result of CHBx on SDOB, as shown in Figure 37.

Output data consist of a channel indicator ('0' for CHx0, or '1' for CHx1), followed by a '0', and then 16, 14, or 12 bits of conversion result along with any trailing zeroes.

This mode can be used for fully- or pseudo-differential inputs (in pseudo-differential mode the sequencer is used to control the input multiplexer). Channel information is available in fully-differential mode only if CID = '0' (CID is forced to '1' in pseudo-differential mode).

The internal FIFO is available in this mode; when used, a single read pulse allows for reading of all stored conversion data. The FIFO should be completely filled when used for the first time in order to ensure proper functionality.

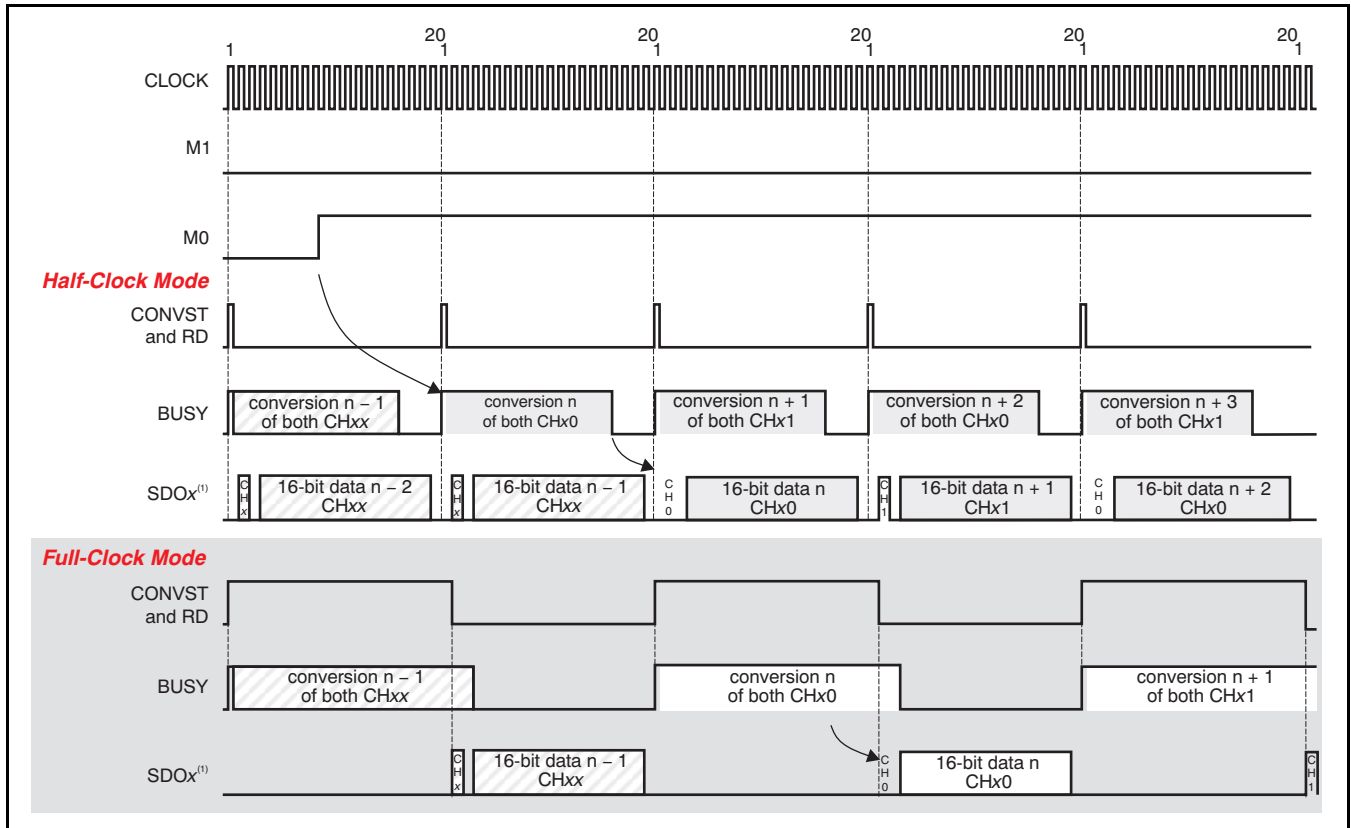

(1) ADS7263/7223 output data with the MSB located as ADS8363 and the last 2/4 bits being '0'.

Figure 37. Mode III Timing
(M0 = '1', M1 = '0', PDE = '0', CID = '0', Fully-Differential Example)

Fully-Differential Mode IV (Half-Clock Mode Only)

In the same way as Mode II, Mode IV uses the SDOA output line exclusively to transmit data while the differential channels are switched automatically. Following the first conversion after M1 goes high, the SDOB output 3-states, as shown in Figure 38.

Output data consist of a channel indicator ('0' for CHx0, or '1' for CHx1), followed by the ADC indicator ('0' for CHAx or '1' for CHBx), and then 16 bits of conversion result, ending with '00' for the ADS8363, '0000' for the ADS7263, or '000000' for the ADS7223.

CONVST and RD signals must not be longer than one clock cycle to ensure proper functionality and avoid corruption of output data.

Full-clock mode is not supported in this operational mode.

Channel information is available in fully-differential mode if CID = '0'. In pseudo-differential mode, the sequencer controls the channel selection in this mode and must be set appropriately using the SEQFIFO register. The internal FIFO is not available in this mode.

Changes to CONFIG register bits FE, SR, PDE, and CID are active with the start of the next conversion with a delay of one read access.

The register settings should be updated using every other RD pulse (aligned either with the one starting the conversion or the one to read the conversion results of channel B; compare with Figure 35).

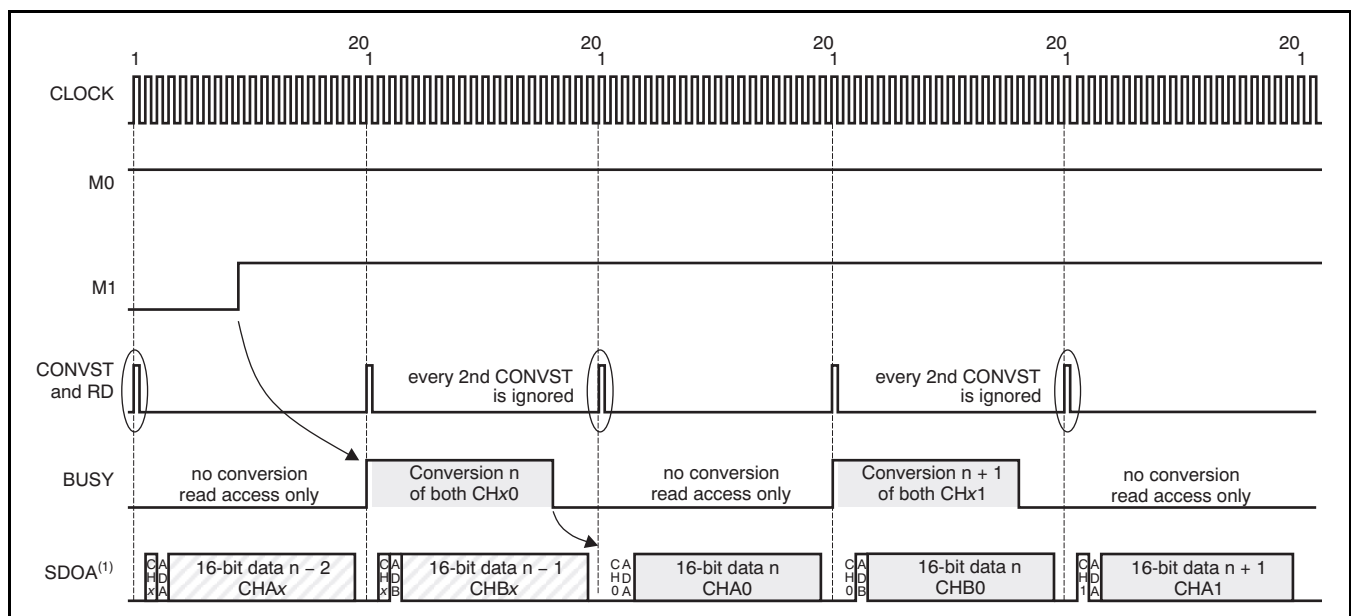

(1) ADS7263/7223 output data with the MSB located as ADS8363 and the last 2/4 bits being '0'.

Figure 38. Fully-Differential Mode IV Timing
(M0 = '1', M1 = '1', PDE = '0', and CID = '0' Example)

Special Mode IV (Half-Clock Mode Only)

As with Special Mode II, these devices also offer a special read mode for Mode IV, where both data results of a conversion can be read by triggering a single RD pulse (refer to Figure 39). Additionally, in this case, the SR bit in the CONFIG register must be set to '1' while the CONVST and RD pins can still be tied together, but are issued every 40 CLOCK cycles instead of 20. The RD signal in this mode must not be longer than one clock cycle to avoid corruption of output data.

Data are available on the SDOA pin, accordingly.

If auto-sleep power-down mode is enabled, the conversion results are presented during the next conversion, as shown in Figure 39.

This mode can be used for fully- or pseudo-differential inputs (note that in pseudo-differential mode, the sequencer is used to control the input multiplexer); channel information is available if CID = '0' in fully-differential mode only (CID forced to '1' in pseudo-differential mode).

The internal FIFO is available in this mode; when used, a single read pulse allows for reading of all stored conversion data. The FIFO should be completely filled when used for the first time in order to ensure proper functionality.

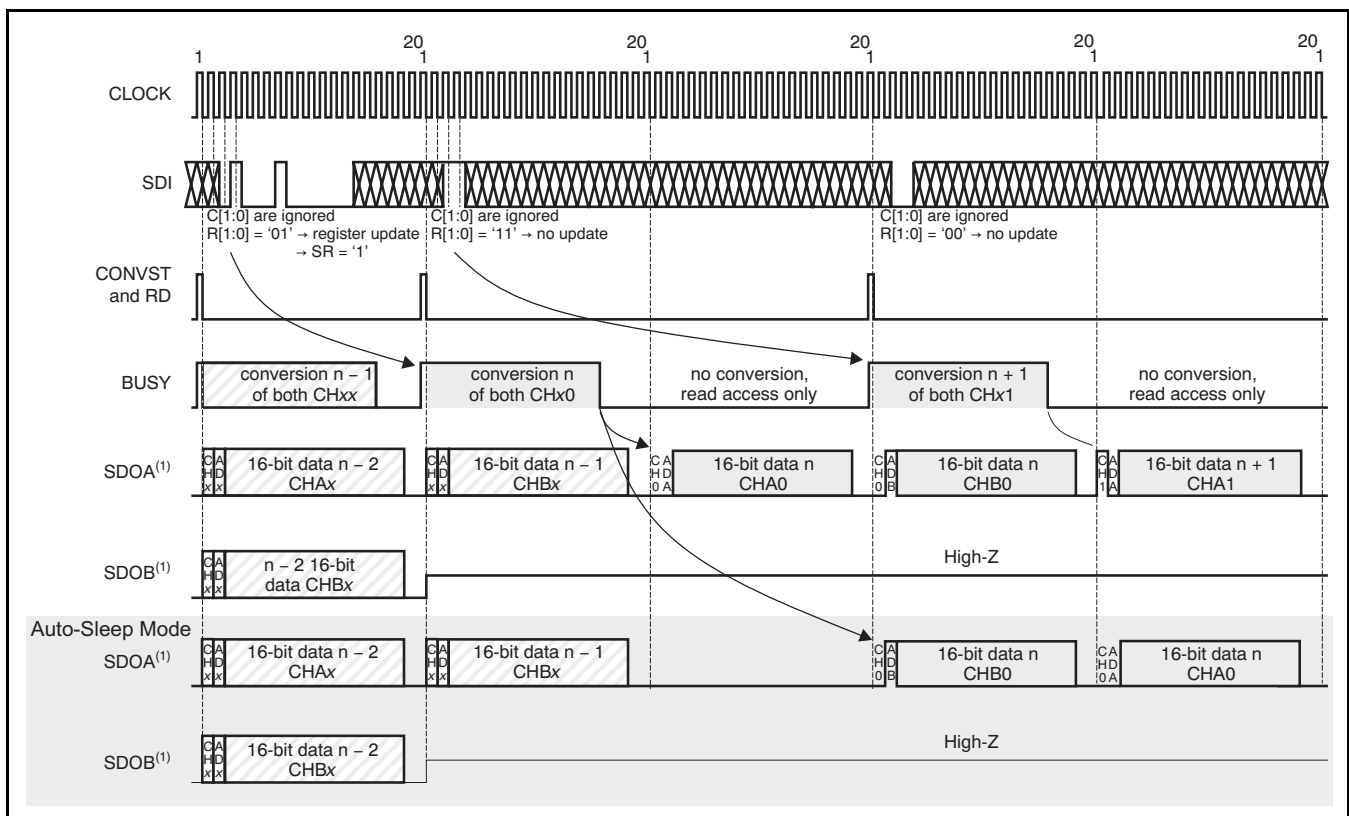

(1) ADS7263/7223 output data with the MSB located as ADS8363 and the last 2/4 bits being '0'.

Figure 39. Special Read Mode IV Timing
 (M0 = '1', M1 = '1', PDE = '0', SR = '1', CID = '0', Fully-Differential Example)

PROGRAMMING THE REFERENCE DAC

The internal reference DACs can be set by issuing an RD pulse while providing a control word with R[1:0] = '01' and A[3:0] = 'X010' or 'X101', depending on which DAC is going to be updated. Thereafter, a second RD pulse must be generated with a control word that starts with the first five bits being ignored followed by the reference power control and the corresponding 10-bit DAC value (refer to Figure 40).

To verify the DACs settings, an RD pulse must be generated while providing a control word containing R[1:0] = '01' and A[3:0] = '0011' or '0110' to initialize the read access of the appropriate DAC register. Triggering the RD line again causes the SDOA output to provide the 16-bit DAC register value followed by '0000', if channel information is disabled (CID = '1').

When channel information is enabled (CID = '0'), the first two bits of the data output contain the currently selected analog input channel indicator ('0' for CHx0 or '1' for CHx1), followed by the 16-bit DAC register contents and an additional '00'. While the register contents are valid on SDOA, the conversion result of channel Ax is lost (if a conversion was performed in parallel), the conversion result of channel Bx is valid on SDOB (if enabled), and data on SDI are ignored, as shown in Figure 40).

The default value of the DAC registers after power-up is 7FFh, corresponding to a disabled reference voltage of 2.5V on both REFIOx pins.

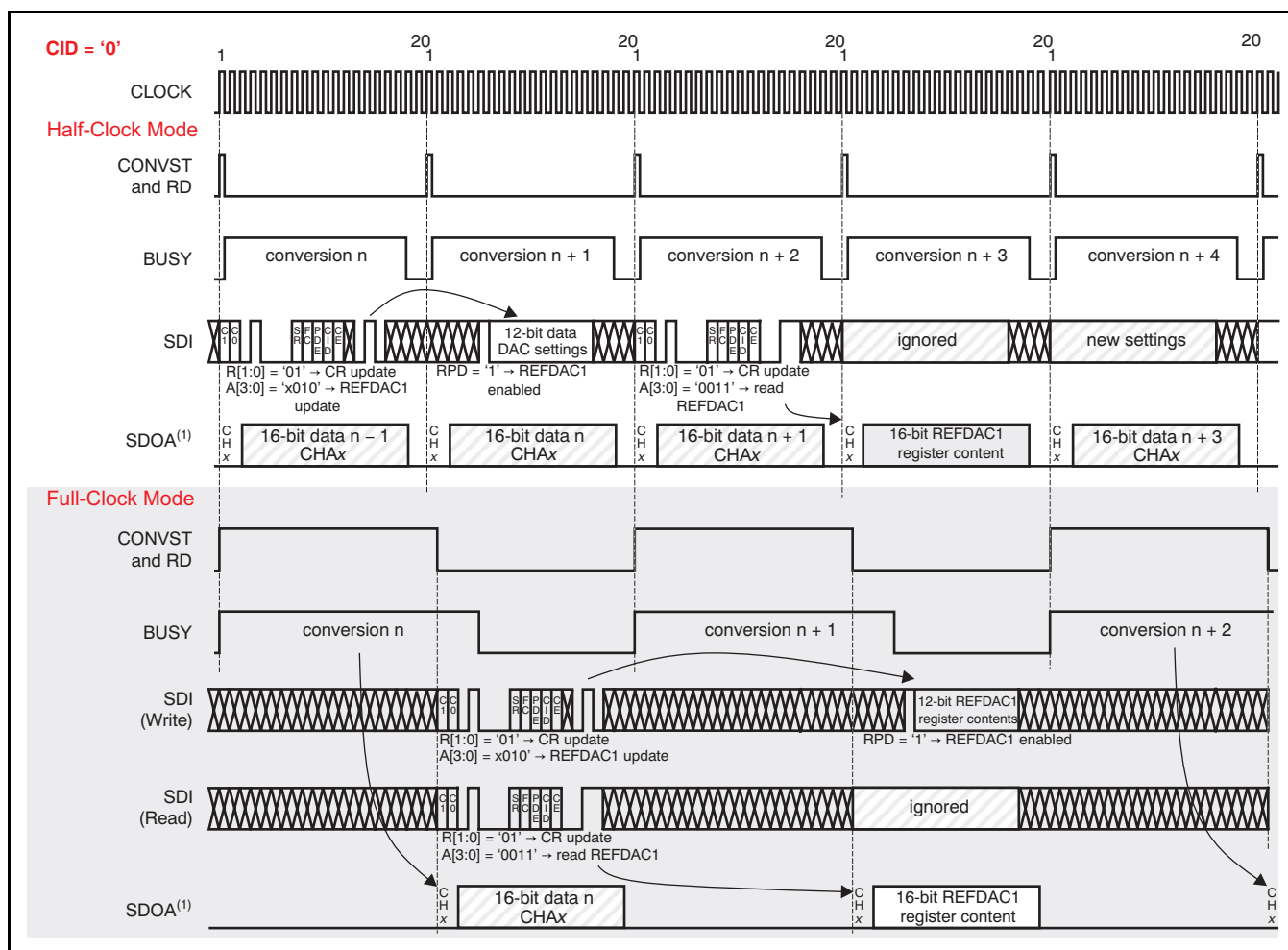

Figure 40. DAC Register Write and Read Access Timing (Both SDOx Active and CID = '0')

POWER-DOWN MODES AND RESET

These devices have a comprehensive built-in power-down feature. There are three power-down modes: Power-Down, Sleep, and Auto-Sleep Power-Down. All three power-down modes are activated with the completion of the write access, during which the related bit(s) are asserted (PD[1:0]). All modes are deactivated by deasserting the respective bit(s) in the CONFIG register. The content of the CONFIG register is not affected by any of the power-down modes. Any ongoing conversion is finished before entering any of the power-down modes. [Table 14](#) summarizes the differences among the three power-down modes.

Power-Down Mode

In Power-Down mode (PD[1:0] = '01'), all functional blocks except the digital interface are disabled. In this mode, the current demand is reduced to 5µA within 20µs. The wakeup time from Power-Down mode is 8ms when using a reference capacitor of 22µF. The device goes into Power-Down mode after completing any ongoing conversions.

Sleep Mode

In Sleep mode (PD[1:0] = '10'), the device reduces its current demand to approximately 0.9mA within 10µs. The device goes into Sleep mode after completing any ongoing conversions.

Auto-Sleep Mode

Auto-Sleep mode is almost identical to Sleep mode. The only differences are the method of activating the mode and waking up the device. CONFIG register bits PD[1:0] = '11' are only used to enable/disable this feature. If the Auto-Sleep mode is enabled, the

device automatically turns off the biasing after finishing a conversion; thus, the end of conversion actually activates Auto-Sleep mode. If Sequencer mode is used and individual conversion start pulses are chosen (S1 = '0'), the device automatically powers-down after each conversion; in case of a single CONVST pulse starting the sequence (S1 = '1'), power-down is activated upon completion of the entire sequence.

The device wakes up with the next CONVST pulse but the analog input is held in sample mode for another seven clock cycles in half-clock mode, or 14 clock cycles in full-clock mode, before starting the actual conversion (BUSY goes high thereafter), as shown in [Figure 41](#). This time is required to settle the internal circuitry to the required voltage levels. The conversion result is delayed in Auto-Sleep mode as shown in [Figure 39](#).

In this mode, the current demand is reduced to approximately 1.2mA within 10µs.

Reset

To issue a device reset, an RD pulse must be generated along with a control word containing A[3:0] = '0100'. With the completion of this write access, the entire device including the serial interface is forced into reset, interrupting any ongoing conversions, setting the input into acquisition mode, and returning the register contents to their default values. After ~20ns, the serial interface becomes active again. The device also supports an automatic power-up reset (POR) that ensures proper (default) settings of the device.

Table 14. Power-Down Modes

POWER-DOWN MODE	POWER-DOWN CURRENT	POWER-DOWN ENABLED BY	POWER-DOWN START BY	DELAY TIME TO POWER-DOWN	NORMAL OPERATION BY	WAKEUP TIME	POWER-DOWN DISABLED BY
Power-Down	5µA	PD[1:0] = '01'	Write access completed	20µs	PD[1:0] = '00'	8ms	PD[1:0] = '00'
Sleep	1.2mA (3.6V)	PD[1:0] = '10'	Write access completed	10µs	PD[1:0] = '00'	7 or 14 CLOCK cycles	PD[1:0] = '00'
Auto-Sleep	1.2mA (3.6V)	PD[1:0] = '11'	Each end of conversion	10µs	CONVST pulse	7 or 14 CLOCK cycles	PD[1:0] = '00'

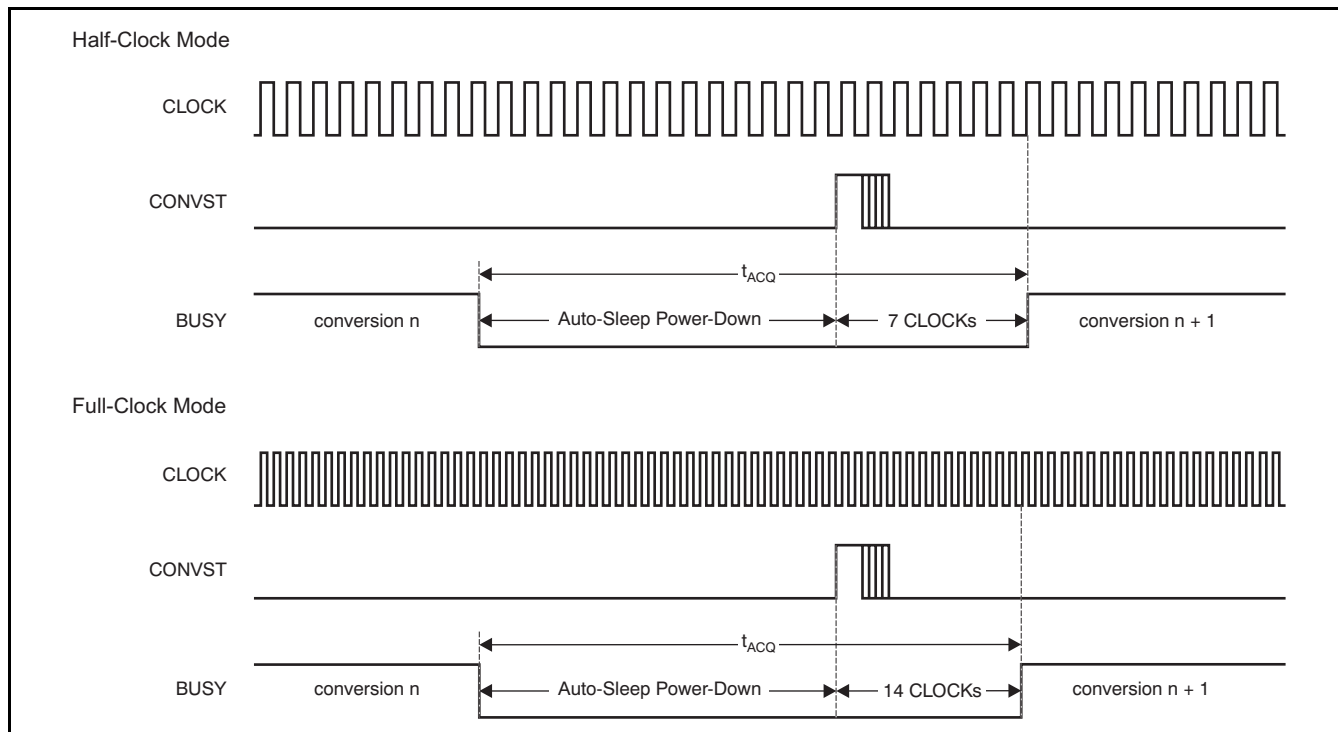

Figure 41. Actual Conversion Start in Auto-Sleep Mode

ADS8361 COMPATIBILITY

This section describes the differences between the ADS8361 and the ADS8363/7263/7223 family of devices in default mode without changing the internal register settings (that are not available on the ADS8361).

Pinout

The ADS8363/7263/7223 family is pin-compatible to ADS8361IRHB. However, there are some differences that must be considered when migrating from an ADS8361-based design, as summarized in Table 15.

Table 15. Pinout Differences Between the ADS8363/7263/7223 and ADS8361

PIN NO.	PIN NAME		IMPACT
	ADS8361	ADS8363/7263/7223	
9	REFIN	REFIO1	If external reference is used, see the Internal Reference section for details. If internal reference is used, REFIO1 must be enabled using the RPD bit in the DAC1 register.
10	REFOUT	REFIO2	Because REFIO2 is disabled by default, no adjustment is required.
11	NC	RGND	If external reference is used, no changes required. If REFIO1 is enabled, this pin should be tied to the analog ground plane with a dedicated via. Furthermore, a 22µF ceramic capacitor should be used between this pin and pin 9.
18	A0	SDI	See the SDI vs. A0 section for details.
29	NC	AVDD	This pin should be connected to the analog supply and decoupled with a 1µF capacitor to ensure proper functionality of the ADS8363/7263/7223 family.
30	NC	AGND	This pin should be connected to the analog ground plane to ensure proper functionality of the ADS8363/7263/7223 family.
31	NC	CMA	In default mode of the ADS8363 family; no changes required.
32	NC	CMB	In default mode of the ADS8363 family; no changes required.

SDI versus A0

Pin 18 (SDI) of the ADS8363/7263/7223 is used to update the internal registers, whereas on the ADS8361, pin 18 (A0) is used in conjunction with M0 to select the input channel.

If, in an existing design, the ADS8361 is used in two-channel mode (M0 = '0') and the status of the A0 pin is unchanged within the first four clock cycles after issuing a conversion start (rising edge of CONVST), the ADS8363/7263/7223 act similarly to the ADS8361 and convert either channels CHx0 (if SDI is held low during the entire period) or channels CHx1 (if SDI is held high during the entire period). [Figure 37](#) shows the behavior of the ADS8363/7263/7223 in such a situation.

The ADS8363/7263/7223 can be also be used to replace the ADS8361 when run in four-channel mode (M0 = '1'). In this case, the A0 pin is held static (high or low), which is also required in for the SDI pin to prevent accidental update of the SDI register.

In both cases described above, the additional features of the ADS8363/7263/7223 (pseudo-differential input mode, programmable reference voltage output, and the various power-down modes) cannot be accessed, but the hardware and software would remain backward-compatible to the ADS8361.

Internal Reference

The internal reference of the ADS8361 delivers 2.5V (typ) after power up, while the reference output of the ADS8363/7263/7223 is powered down by default. In this case, the unbuffered reference input has a code-dependent input impedance, while the ADS8361 offers a high-impedance (buffered) reference input. If an existing ADS8361-based design uses the internal reference of the device and relies on an external resistor divider to adjust the input voltage range of the ADC, migration to the ADS8363 family requires one of the following conditions:

- A software change to setup internal reference DAC1 properly through SDI while removing the external resistors; or
- An additional external buffer between the resistor divider and the required 22µF (min) capacitor on the REFIO1 input.

In the latter case, while the capacitor stabilizes the reference voltage during the entire conversion, the buffer must recharge it by providing an average current only; thus, the required minimum bandwidth of the buffer can be calculated using [Equation 4](#):

$$f_{-3dB} = \frac{\ln(2) \times 2}{2\pi \times 20t_{CLK}} \quad (4)$$

The buffer must also be capable of driving the 22µF load while maintaining its stability.

Timing

In half-clock mode (default), the ADS8363/7263/7223 family of devices provides the conversion delay after completion of the conversion (see [Figure 1](#)), while the ADS8361 offers the conversion result during the conversion process.

RD

The ADS8363/7263/7223 output the first bit with the falling edge of the RD input. The ADS8361 starts the data transfer with the first falling edge of the clock if RD is high.

If the ADS8363/7263/7223 operate with half-clock timing in modes II and IV, the RD input should not be held high longer than one clock cycle to ensure proper function of the data output SDOA.

CONVST

If the ADS8363/7263/7223 operate with half-clock timing in modes II and IV, the CONVST input must not be held high longer than one clock cycle to ensure proper function of the device.

APPLICATION INFORMATION

MINIMUM CONFIGURATION EXAMPLE

An example of a minimum configuration for the ADS8363/7263/7223 is shown in Figure 42. In this case, the device is used in dual-channel, fully-differential input mode with a four-wire digital interface connected to the controller device and with default settings of the device after power up. Because the internal reference is disabled upon power up (to prevent driving against an external reference if used), an external reference source is shown in this example. To allow the use of the internal reference, the SDI input must be connected to the controller, allowing access to the REFDAC registers. The corresponding timing diagram including the timing requirements are shown in Figure 43 and the [Timing Characteristics](#) table.

The input signal for the amplifiers must fulfill the common-mode voltage requirements of the device in this configuration. The actual values of the resistors and capacitors depend on the bandwidth and performance requirements of the application.

Those values can be calculated using Equation 5:

$$f_{\text{FILTER}} = \frac{\ln(2)(n + 1)}{2\pi 2RC}$$

Where $n = 16$ as the resolution of the ADS8363 ($n = 14$ for ADS7263, $n = 12$ for ADS7223). (5)

As a good trade-off between required minimum driver bandwidth and the capacitor value, it is recommended to use a capacitor value of at least 1nF.

Keeping the acquisition time in mind, the resistor value can be calculated as shown in Equation 6 for each of the series resistors:

$$R = \frac{t_{\text{ACQ}}}{\ln(2)(n + 1)2C}$$

Where $n =$ the device resolution. (6)

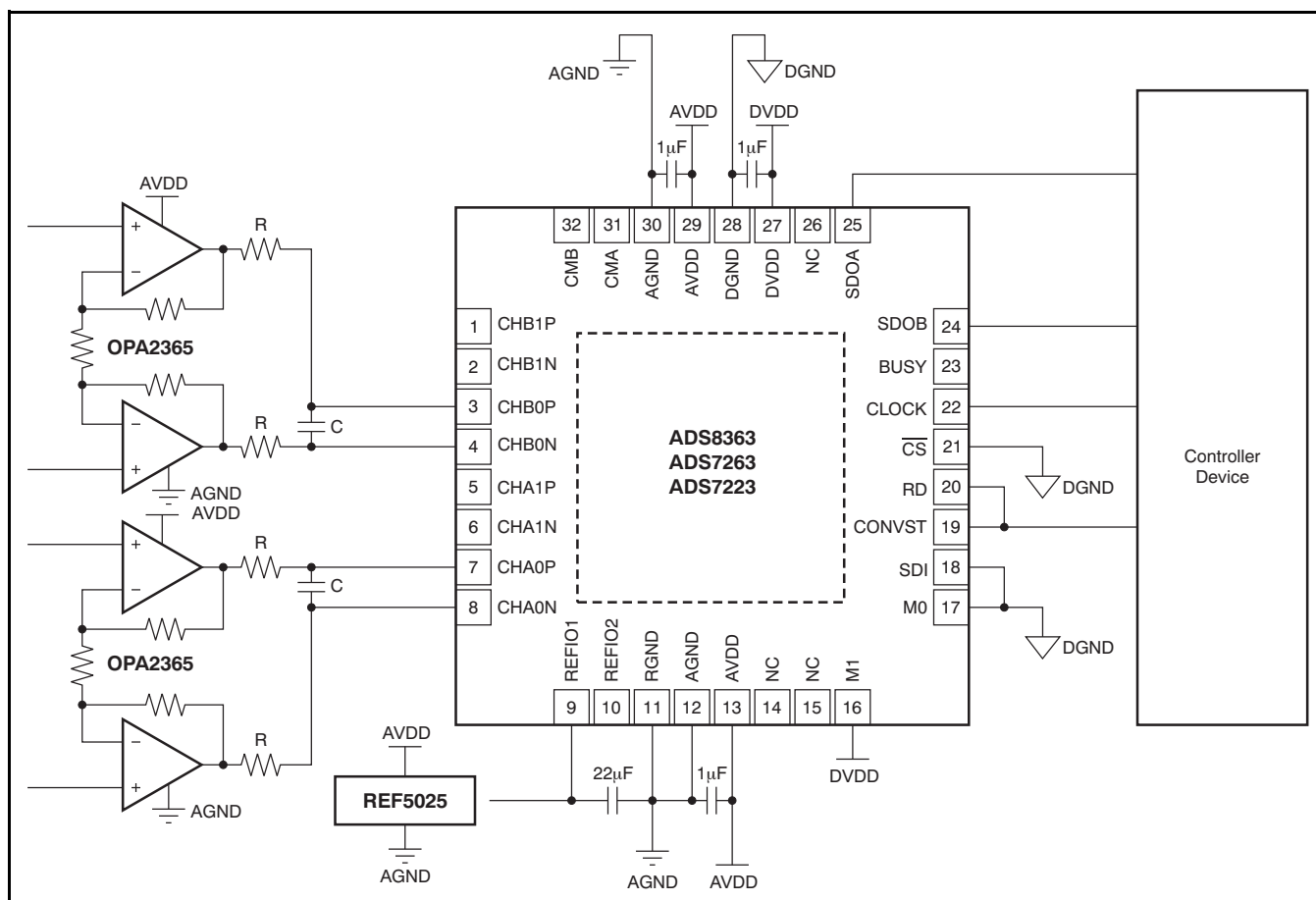

Figure 42. Four-Wire Application Configuration

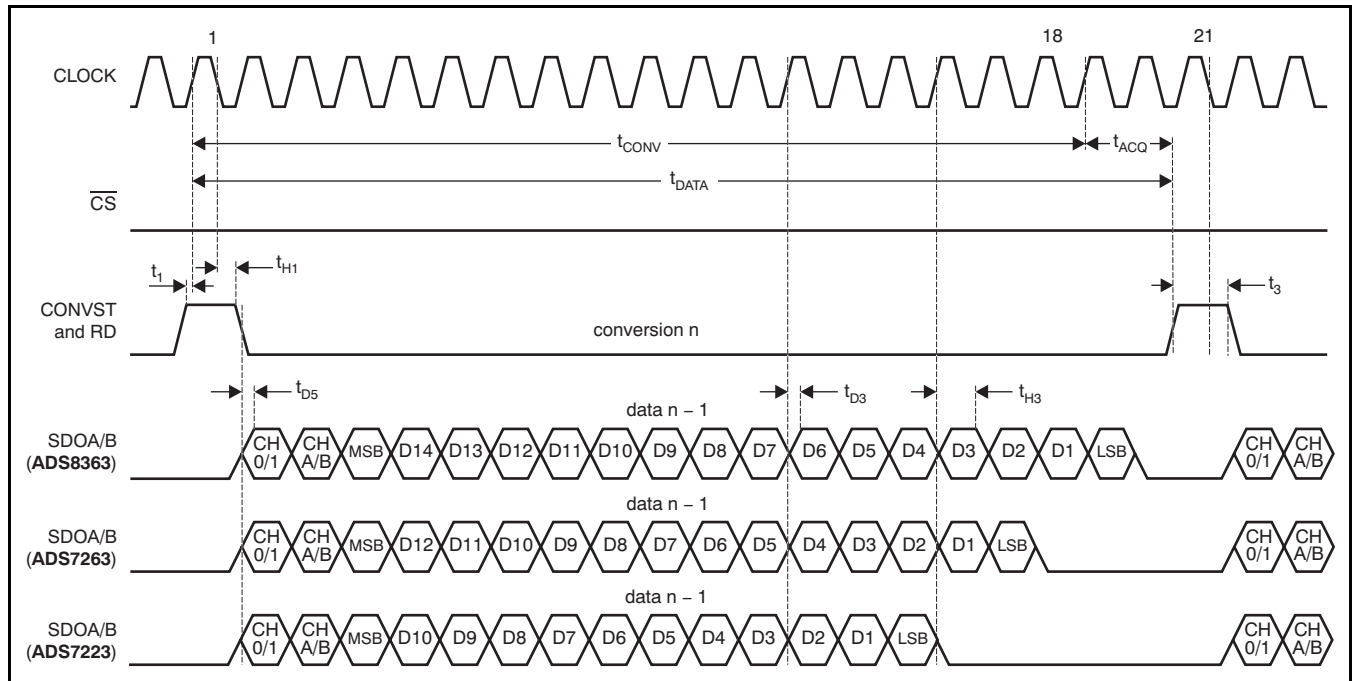

Figure 43. Four-Wire Application Timing (Half-Clock Mode)

LAYOUT

For optimum performance, care should be taken with the physical layout of the ADS8363/7263/7223 circuitry, particularly if the device is used at the maximum throughput rate. In this case, it is recommended to have a fixed phase relationship between CLOCK and CONVST.

Additionally, the high-performance SAR architecture is sensitive to glitches or sudden changes on the power supply, reference, ground connections, and digital inputs that occur just before latching the output of the internal analog comparator. Therefore, during an operation of an n -bit SAR converter, there are n windows in which large external transient voltages (glitches) can affect the conversion result. Such glitches might originate from switching power supplies, nearby digital logic, or high-power devices. The degree of impact depends on the reference voltage, layout, and the actual timing of the external event.

With this possibility in mind, power to the device should be clean and well-bypassed. A $1\mu\text{F}$ ceramic bypass capacitor should be placed at each supply pin (connected to the corresponding ground pin) as close to the device as possible.

If the reference voltage is external, the operational amplifier should be able to drive the $22\mu\text{F}$ capacitor without oscillation. A series resistor between the driver output and the capacitor may be required. To minimize any code-dependent voltage drop on this path, a small value should be used for this resistor (10Ω max). TI's REF50xx family is able to directly drive such a capacitive load.

GROUNDING

The AGND, RGND, and DGND pins should be connected to a clean ground reference. All connections should be kept as short as possible to minimize the inductance of these paths. It is recommended to use vias connecting the pads directly to the ground plane. In designs without ground planes, the ground trace should be kept as wide as possible. Avoid connections that are close to the grounding point of a microcontroller or digital signal processor.

Depending on the circuit density of the board, placement of the analog and digital components, and the related current loops, a single solid ground plane

for the entire printed circuit board (PCB) or a dedicated analog ground area may be used. In case of a separated analog ground area, ensure a low-impedance connection between the analog and digital ground of the ADC by placing a bridge underneath (or next) to the ADC (see [Figure 44](#)). Otherwise, even short undershoots on the digital interface with a value of less than -300mV can lead to conduction of ESD diodes, causing current flow through the substrate and degrading the analog performance.

During the layout of the PCB, care should be taken to avoid any return currents crossing any sensitive analog areas or signals. No signal must exceed the limit of -300mV with respect to the corresponding (AGND or DGND) ground plane.

SUPPLY

The ADS8363/7263 has two separate supplies: the DVDD pin for the buffers of the digital interface and the AVDD pin for all the remaining circuits.

DVDD can range from 2.3V to 5.5V, allowing the ADC to easily interface with processors and controllers. To limit the injection of noise energy from external digital circuitry, DVDD should be properly filtered. A bypass capacitor of $1\mu\text{F}$ should be placed between the DVDD pin and the digital ground plane.

AVDD supplies the internal analog circuitry. For optimum performance, a linear regulator (for example, the [UA7805](#) family) is recommended to generate the analog supply voltage in the range of 2.7V to 5.5V for the ADC and the necessary analog front-end.

Bypass capacitors of $1\mu\text{F}$ should be connected to the analog ground plane such that the current is allowed to flow through the pad of these capacitors (that is, the vias should be placed on the opposite side of the connection between the capacitor and the power-supply pin of the ADC).

DIGITAL INTERFACE

To further optimize performance of the device, a series resistor of between 10Ω to 100Ω can be used on each digital pin of the device. In this way, the slew rate of the input and output signals is reduced, limiting the noise injection from the digital interface.

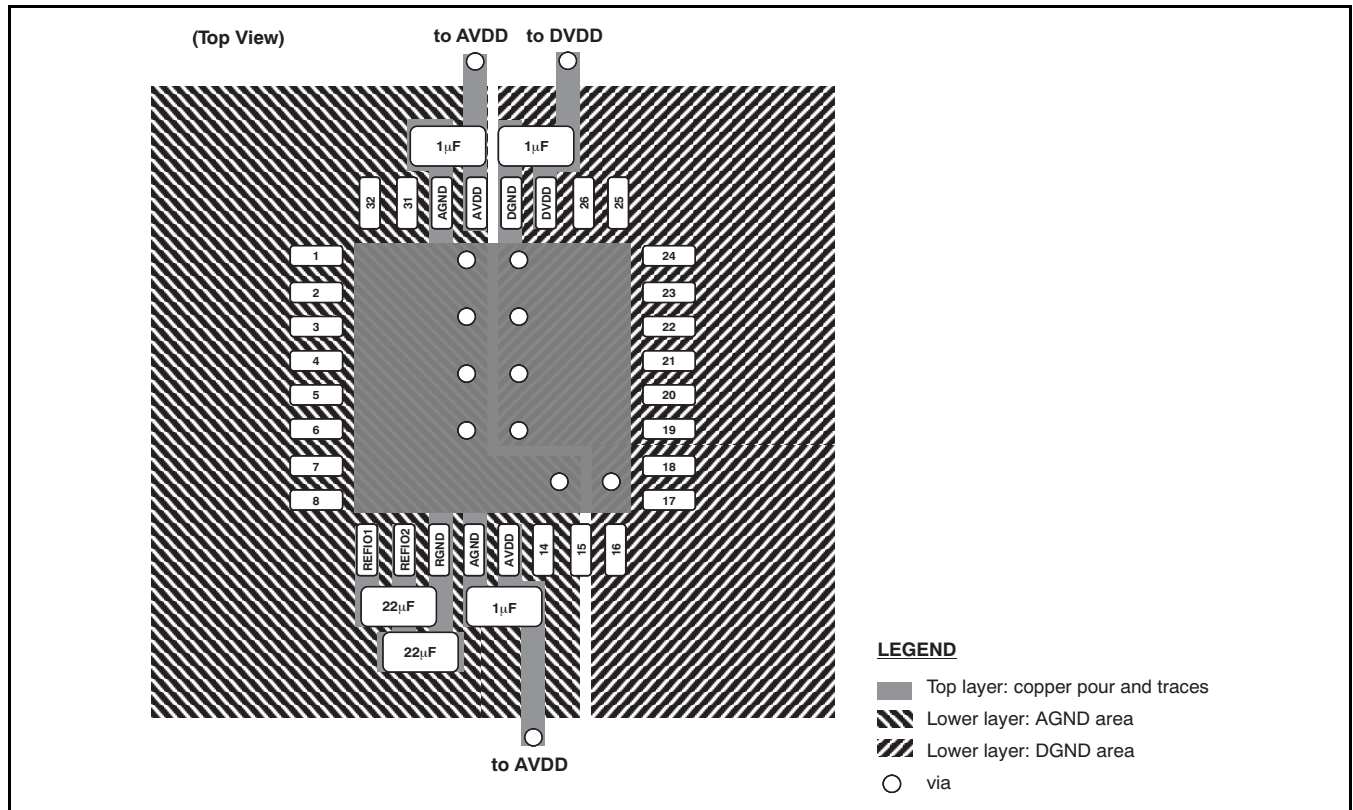

Figure 44. Optimized Layout Recommendation

REVISION HISTORY

NOTE: Page numbers for previous revisions may differ from page numbers in the current version.

Changes from Revision A (December, 2010) to Revision B	Page
• Revised test conditions for gain error parameter	3
• Revised test conditions for gain error parameter	3
• Revised test conditions for gain error parameter	4
• Updated CONVST high time specification	11
• Revised <i>CONVST</i> section	17
• Revised <i>Mode II</i> section	30
• Revised <i>Special Read Mode II</i> section	31
• Revised <i>Fully-Differential Mode IV</i> section	33
• Revised <i>Special Mode IV</i> section	34
• Added <i>CONVST</i> section in <i>ADS8361 Compatibility</i>	38

Changes from Original (October, 2010) to Revision A	Page
• Updated <i>Figure 1</i>	9
• Added RD high time (t_3) parameter to <i>Timing Characteristics</i> table	11
• Revised <i>RD</i> section in <i>ADS8361 Compatibility</i>	38
• Added t_3 timing trace to <i>Figure 43</i>	40
• Deleted <i>Four-Wire Application Timing Requirements</i> table	40

PACKAGING INFORMATION

Orderable Device	Status ⁽¹⁾	Package Type	Package Drawing	Pins	Package Qty	Eco Plan ⁽²⁾	Lead/ Ball Finish	MSL Peak Temp ⁽³⁾	Samples (Requires Login)
ADS7223SRHBR	ACTIVE	QFN	RHB	32	3000	Green (RoHS & no Sb/Br)	CU NIPDAU	Level-3-260C-168 HR	
ADS7223SRHBT	ACTIVE	QFN	RHB	32	250	Green (RoHS & no Sb/Br)	CU NIPDAU	Level-3-260C-168 HR	
ADS7263SRHBR	ACTIVE	QFN	RHB	32	3000	Green (RoHS & no Sb/Br)	CU NIPDAU	Level-3-260C-168 HR	
ADS7263SRHBT	ACTIVE	QFN	RHB	32	250	Green (RoHS & no Sb/Br)	CU NIPDAU	Level-3-260C-168 HR	
ADS8363SRHBR	ACTIVE	QFN	RHB	32	3000	Green (RoHS & no Sb/Br)	CU NIPDAU	Level-3-260C-168 HR	
ADS8363SRHBT	ACTIVE	QFN	RHB	32	250	Green (RoHS & no Sb/Br)	CU NIPDAU	Level-3-260C-168 HR	

⁽¹⁾ The marketing status values are defined as follows:

ACTIVE: Product device recommended for new designs.

LIFEBUY: TI has announced that the device will be discontinued, and a lifetime-buy period is in effect.

NRND: Not recommended for new designs. Device is in production to support existing customers, but TI does not recommend using this part in a new design.

PREVIEW: Device has been announced but is not in production. Samples may or may not be available.

OBSELETE: TI has discontinued the production of the device.

⁽²⁾ Eco Plan - The planned eco-friendly classification: Pb-Free (RoHS), Pb-Free (RoHS Exempt), or Green (RoHS & no Sb/Br) - please check <http://www.ti.com/productcontent> for the latest availability information and additional product content details.

TBD: The Pb-Free/Green conversion plan has not been defined.

Pb-Free (RoHS): TI's terms "Lead-Free" or "Pb-Free" mean semiconductor products that are compatible with the current RoHS requirements for all 6 substances, including the requirement that lead not exceed 0.1% by weight in homogeneous materials. Where designed to be soldered at high temperatures, TI Pb-Free products are suitable for use in specified lead-free processes.

Pb-Free (RoHS Exempt): This component has a RoHS exemption for either 1) lead-based flip-chip solder bumps used between the die and package, or 2) lead-based die adhesive used between the die and leadframe. The component is otherwise considered Pb-Free (RoHS compatible) as defined above.

Green (RoHS & no Sb/Br): TI defines "Green" to mean Pb-Free (RoHS compatible), and free of Bromine (Br) and Antimony (Sb) based flame retardants (Br or Sb do not exceed 0.1% by weight in homogeneous material)

⁽³⁾ MSL, Peak Temp. -- The Moisture Sensitivity Level rating according to the JEDEC industry standard classifications, and peak solder temperature.

Important Information and Disclaimer: The information provided on this page represents TI's knowledge and belief as of the date that it is provided. TI bases its knowledge and belief on information provided by third parties, and makes no representation or warranty as to the accuracy of such information. Efforts are underway to better integrate information from third parties. TI has taken and continues to take reasonable steps to provide representative and accurate information but may not have conducted destructive testing or chemical analysis on incoming materials and chemicals. TI and TI suppliers consider certain information to be proprietary, and thus CAS numbers and other limited information may not be available for release.

In no event shall TI's liability arising out of such information exceed the total purchase price of the TI part(s) at issue in this document sold by TI to Customer on an annual basis.

RHB (S-PVQFN-N32)

PLASTIC QUAD FLATPACK NO-LEAD

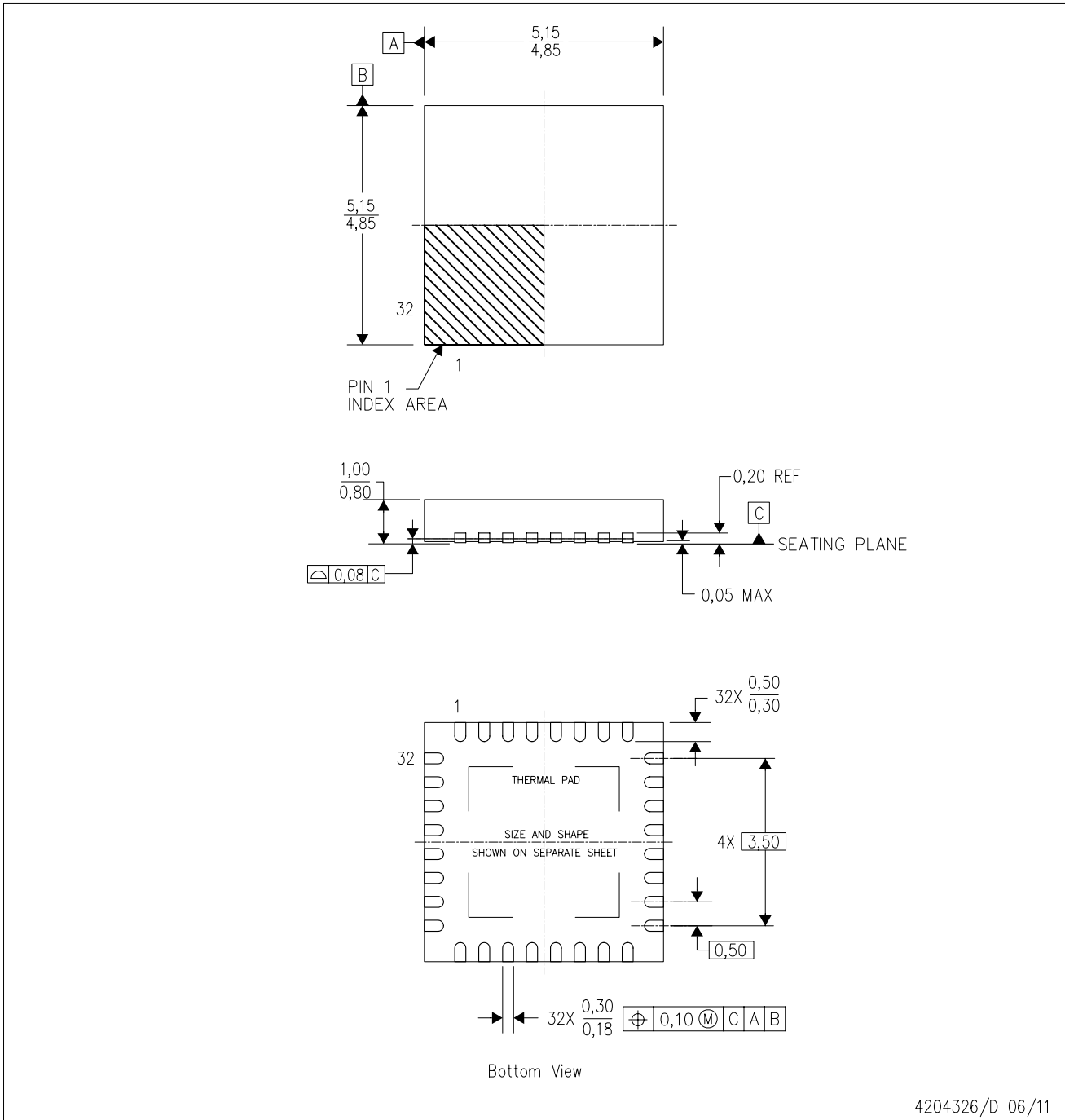

4204326/D 06/11

- NOTES:
- All linear dimensions are in millimeters. Dimensioning and tolerancing per ASME Y14.5M-1994.
 - This drawing is subject to change without notice.
 - QFN (Quad Flatpack No-Lead) Package configuration.
 - The package thermal pad must be soldered to the board for thermal and mechanical performance.
 - See the additional figure in the Product Data Sheet for details regarding the exposed thermal pad features and dimensions.
 - Falls within JEDEC MO-220.

THERMAL PAD MECHANICAL DATA

RHB (S-PVQFN-N32)

PLASTIC QUAD FLATPACK NO-LEAD

THERMAL INFORMATION

This package incorporates an exposed thermal pad that is designed to be attached directly to an external heatsink. The thermal pad must be soldered directly to the printed circuit board (PCB). After soldering, the PCB can be used as a heatsink. In addition, through the use of thermal vias, the thermal pad can be attached directly to the appropriate copper plane shown in the electrical schematic for the device, or alternatively, can be attached to a special heatsink structure designed into the PCB. This design optimizes the heat transfer from the integrated circuit (IC).

For information on the Quad Flatpack No-Lead (QFN) package and its advantages, refer to Application Report, QFN/SON PCB Attachment, Texas Instruments Literature No. SLUA271. This document is available at www.ti.com.

The exposed thermal pad dimensions for this package are shown in the following illustration.

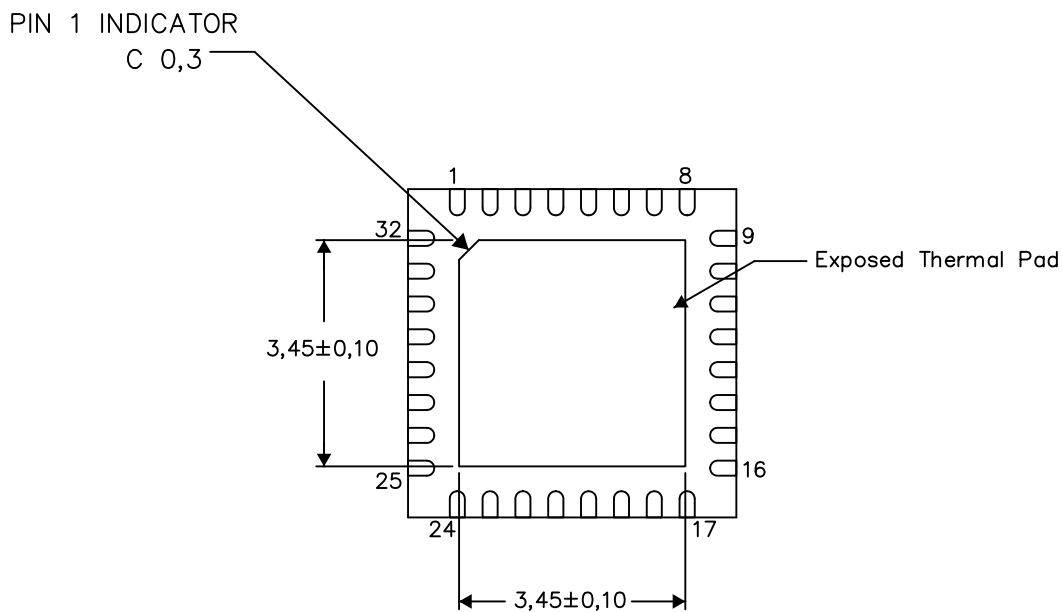

Exposed Thermal Pad Dimensions

4206356-2/W 09/12

NOTE: A. All linear dimensions are in millimeters

IMPORTANT NOTICE

Texas Instruments Incorporated and its subsidiaries (TI) reserve the right to make corrections, enhancements, improvements and other changes to its semiconductor products and services per JESD46, latest issue, and to discontinue any product or service per JESD48, latest issue. Buyers should obtain the latest relevant information before placing orders and should verify that such information is current and complete. All semiconductor products (also referred to herein as "components") are sold subject to TI's terms and conditions of sale supplied at the time of order acknowledgment.

TI warrants performance of its components to the specifications applicable at the time of sale, in accordance with the warranty in TI's terms and conditions of sale of semiconductor products. Testing and other quality control techniques are used to the extent TI deems necessary to support this warranty. Except where mandated by applicable law, testing of all parameters of each component is not necessarily performed.

TI assumes no liability for applications assistance or the design of Buyers' products. Buyers are responsible for their products and applications using TI components. To minimize the risks associated with Buyers' products and applications, Buyers should provide adequate design and operating safeguards.

TI does not warrant or represent that any license, either express or implied, is granted under any patent right, copyright, mask work right, or other intellectual property right relating to any combination, machine, or process in which TI components or services are used. Information published by TI regarding third-party products or services does not constitute a license to use such products or services or a warranty or endorsement thereof. Use of such information may require a license from a third party under the patents or other intellectual property of the third party, or a license from TI under the patents or other intellectual property of TI.

Reproduction of significant portions of TI information in TI data books or data sheets is permissible only if reproduction is without alteration and is accompanied by all associated warranties, conditions, limitations, and notices. TI is not responsible or liable for such altered documentation. Information of third parties may be subject to additional restrictions.

Resale of TI components or services with statements different from or beyond the parameters stated by TI for that component or service voids all express and any implied warranties for the associated TI component or service and is an unfair and deceptive business practice. TI is not responsible or liable for any such statements.

Buyer acknowledges and agrees that it is solely responsible for compliance with all legal, regulatory and safety-related requirements concerning its products, and any use of TI components in its applications, notwithstanding any applications-related information or support that may be provided by TI. Buyer represents and agrees that it has all the necessary expertise to create and implement safeguards which anticipate dangerous consequences of failures, monitor failures and their consequences, lessen the likelihood of failures that might cause harm and take appropriate remedial actions. Buyer will fully indemnify TI and its representatives against any damages arising out of the use of any TI components in safety-critical applications.

In some cases, TI components may be promoted specifically to facilitate safety-related applications. With such components, TI's goal is to help enable customers to design and create their own end-product solutions that meet applicable functional safety standards and requirements. Nonetheless, such components are subject to these terms.

No TI components are authorized for use in FDA Class III (or similar life-critical medical equipment) unless authorized officers of the parties have executed a special agreement specifically governing such use.

Only those TI components which TI has specifically designated as military grade or "enhanced plastic" are designed and intended for use in military/aerospace applications or environments. Buyer acknowledges and agrees that any military or aerospace use of TI components which have **not** been so designated is solely at the Buyer's risk, and that Buyer is solely responsible for compliance with all legal and regulatory requirements in connection with such use.

TI has specifically designated certain components which meet ISO/TS16949 requirements, mainly for automotive use. Components which have not been so designated are neither designed nor intended for automotive use; and TI will not be responsible for any failure of such components to meet such requirements.

Products

Audio	www.ti.com/audio
Amplifiers	amplifier.ti.com
Data Converters	dataconverter.ti.com
DLP® Products	www.dlp.com
DSP	dsp.ti.com
Clocks and Timers	www.ti.com/clocks
Interface	interface.ti.com
Logic	logic.ti.com
Power Mgmt	power.ti.com
Microcontrollers	microcontroller.ti.com
RFID	www.ti-rfid.com
OMAP Applications Processors	www.ti.com/omap
Wireless Connectivity	www.ti.com/wirelessconnectivity

Applications

Automotive and Transportation	www.ti.com/automotive
Communications and Telecom	www.ti.com/communications
Computers and Peripherals	www.ti.com/computers
Consumer Electronics	www.ti.com/consumer-apps
Energy and Lighting	www.ti.com/energy
Industrial	www.ti.com/industrial
Medical	www.ti.com/medical
Security	www.ti.com/security
Space, Avionics and Defense	www.ti.com/space-avionics-defense
Video and Imaging	www.ti.com/video

TI E2E Community

e2e.ti.com