



Dual, Variable Gain Amplifier

FEATURES

- **INDEPENDENT CHANNEL CONTROLS:**
 - Gain Range: 48dB
 - Clamping Levels
 - Post-Gain: 0, +6dB
- **LOW NOISE:** 4.1nV/√Hz
- **LOW POWER:** 52mW/Channel
- **BANDWIDTH:** 50MHz
- **HARMONIC DISTORTION:** –53dBc at 5MHz
- **CROSSTALK:** –61dB at 5MHz
- **5V SINGLE SUPPLY**
- **POWER-DOWN MODE**
- **SMALL QFN-32 PACKAGE (5x5mm)**

APPLICATIONS

- **MEDICAL AND INDUSTRIAL ULTRASOUND SYSTEMS**
 - Suitable for 10-Bit and 12-Bit Systems
- **TEST EQUIPMENT**
- **SONAR**

DESCRIPTION

The VCA2617 is a dual-channel, continuously variable, voltage-controlled gain amplifier well-suited for a variety of ultrasound systems as well as applications in proximity detectors and test equipment. The VCA2617 uses a true variable-gain amplifier architecture, achieving very good noise performance at low gains, while not sacrificing high gain distortion performance.

Following a linear-in-dB response, the VCA2617 gain can be varied over a 48dB range with a 0.2V to 2.3V control voltage. Two separate high-impedance control inputs allow for a channel independent variation of the gains. Each channel of the VCA2617 can be configured to provide a gain range of –10dB to 38dB, or –16dB to 32dB, depending on the gain select pin (HG). This post-gain feature allows the user to optimize the output swing of VCA2617 for a variety of high-speed analog-to-digital converters (ADC). As a means to improve system overload recovery time, the VCA2617 also provides an internal clamping circuitry where an externally applied voltage sets the desired output clamping level.

The VCA2617 operates on a single +5V supply while consuming only 52mW per channel. It is available in a small QFN-32 package (5x5mm).

RELATED PRODUCTS

PART NUMBER	DESCRIPTION
VCA2615	Dual, Low-Noise, Variable-Gain Amplifier with Preamp

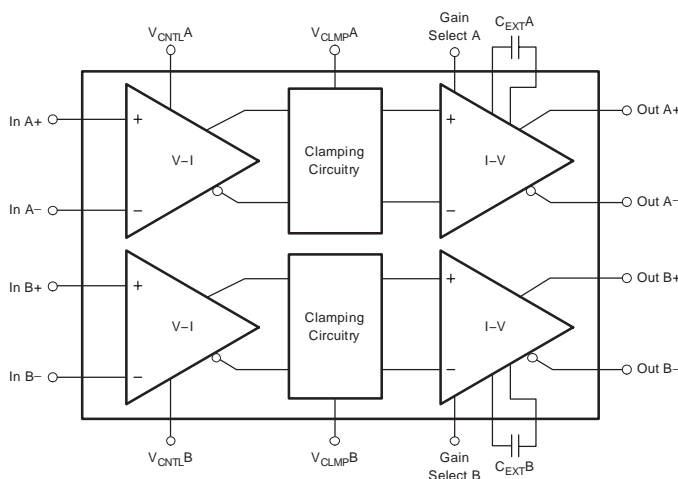

Please be aware that an important notice concerning availability, standard warranty, and use in critical applications of Texas Instruments semiconductor products and disclaimers thereto appears at the end of this data sheet.

All trademarks are the property of their respective owners.

ABSOLUTE MAXIMUM RATINGS(1)

Power Supply (V _{DD}) +6V
VCA2617 Analog Input -0.3V to (+V _S + 0.3V)
Logic Input -0.3V to (+V _S + 0.3V)
Case Temperature +100°C
Junction Temperature +150°C
Storage Temperature -40°C to +150°C

(1) Stresses above those listed under *Absolute Maximum Ratings* may cause permanent damage. Exposure to absolute maximum conditions for extended periods may affect device reliability.



This integrated circuit can be damaged by ESD. Texas Instruments recommends that all integrated circuits be handled with appropriate precautions. Failure to observe proper handling and installation procedures can cause damage.

ESD damage can range from subtle performance degradation to complete device failure. Precision integrated circuits may be more susceptible to damage because very small parametric changes could cause the device not to meet its published specifications.

PACKAGE/ORDERING INFORMATION(1)

PRODUCT	PACKAGE-LEAD	PACKAGE DESIGNATOR	SPECIFIED TEMPERATURE RANGE	PACKAGE MARKING	ORDERING NUMBER	TRANSPORT MEDIA, QUANTITY
VCA2617	QFN-32	RHB	-40°C to +85°C	VCA2617	VCA2617RHBT	Tape and Reel, 250
					VCA2617RHBR	Tape and Reel, 3000

(1) For the most current package and ordering information, see the Package Option Addendum at the end of this document, or see the TI website at www.ti.com.

ELECTRICAL CHARACTERISTICS

 All specifications at $T_A = +25^\circ\text{C}$, $V_{DD} = 5\text{V}$, load resistance = 500Ω on each output to ground, differential output (1V_{PP}), $C_A, C_B = 3.9\mu\text{F}$, single-ended input configuration, $f_{IN} = 5\text{MHz}$, $\overline{\text{HG}} = \text{Low}$ (High-Gain Mode), $V_{CNTL} = 2.3\text{V}$, unless otherwise noted.

PARAMETER	CONDITIONS	VCA2617			UNIT
		MIN	TYP	MAX	
VARIABLE GAIN AMPLIFIER					
Input Resistance	Single-Ended		300		k Ω
Input Capacitance			8		pF
Maximum Input Voltage	Linear Operation ⁽¹⁾ ; Each Input		2.0		V_{PP}
Differential			1.0		V_{PP}
Single-Ended			4.1		$\text{nV}/\sqrt{\text{Hz}}$
Input Voltage Noise	Gain = 45dB, $R_S = 0\Omega$		1		$\text{pA}/\sqrt{\text{Hz}}$
Input Current Noise	Independent of Gain		13.3		dB
Noise Figure			2.5		V
Input Common-Mode Voltage	Internal		50		MHz
Bandwidth			0.25 to 2.6		V
Clipping Voltage Range (V_{CLMP})			± 75		mV
Clipping Voltage Variation	$V_{CLMP} = 0.5\text{V}$, $V_{CAOUT} = 1.0\text{V}_{PP}$		80		pF
Maximum Capacitive Output Loading	50Ω in Series		100		V/ μs
Slew Rate			6		V_{PP}
Maximum Output Signal ⁽¹⁾			2.5		V
Output Common-Mode Voltage			3		Ω
Output Impedance	at 5MHz, Single-Ended, Either Output		60		mA
Output Short-Circuit Current			-43		dBc
2nd-Harmonic Distortion	$V_{OUT} = 1\text{V}_{PP}$, $V_{CNTL} = 1.5\text{V}$	-43	-53		dBc
3rd-Harmonic Distortion	$V_{OUT} = 1\text{V}_{PP}$, $V_{CNTL} = 1.5\text{V}$	-43	-62		dBc
Overload Distortion (2nd-Harmonic)	Input Signal = 1V_{PP} , $V_{CNTL} = 2\text{V}$		-40		dBc
Crosstalk			-61		dB
Delay Matching			± 1		ns
ACCURACY					
Gain Slope	$V_{CNTL} = 0.4\text{V}$ to 2.0V		22		dB/V
Gain Error ⁽²⁾	$V_{CNTL} = 0.4\text{V}$ to 2.0V	-2	± 0.9	+2	dB
Gain Range	$V_{CNTL} = 0.2\text{V}$ to 2.3V		48		dB
	$V_{CNTL} = 0.4\text{V}$ to 2.0V		35.5		dB
Gain Range ($\overline{\text{HG}}$)	$\overline{\text{HG}} = 0$ (+6dB); VGA High Gain; $V_{CNTL} = 0.2\text{V}$ to 2.3V		-10 to +38		dB
	$\overline{\text{HG}} = 1$ (0dB); VGA Low Gain; $V_{CNTL} = 0.2\text{V}$ to 2.3V		-16 to +32		dB
Output Offset Voltage, Differential			± 50		mV
Channel-to-Channel Gain Matching	$V_{CNTL} = 0.4\text{V}$ to 2.0V		± 0.8		dB
GAIN CONTROL INTERFACE (V_{CNTL})					
Input Voltage Range			0.2 to 2.3		V
Input Resistance			1		M Ω
Response Time	42dB Gain Change; to 90% Signal Level		0.5		μs
DIGITAL INPUTS⁽³⁾, (4)					
($\overline{\text{HGA}}$, $\overline{\text{HGB}}$, $\overline{\text{PD}}$)					
V_{IH} , High-Level Input Voltage		2.0			V
V_{IL} , Low-Level Input Voltage				0.8	V
Input Resistance			1		M Ω
Input Capacitance			5		pF
POWER SUPPLY					
Supply Voltage		4.75	5.0	5.25	V
Power Dissipation			105	125	mW
Power-Down			22		mW
Power-Up Response Time			25		μs
Power-Down Response Time			2		μs
THERMAL CHARACTERISTICS					
Temperature Range	Ambient, Operating	-40		+85	$^\circ\text{C}$
Thermal Resistance, θ_{JA}	Soldered Pad; Four-Layer PCB with Thermal Vias		36.7		$^\circ\text{C}/\text{W}$
θ_{JC}			4.0		$^\circ\text{C}/\text{W}$

 (1) 2nd, 3rd-harmonic distortion less than or equal to -30dBc .

(2) Referenced to best fit dB-linear curve.

(3) Parameters ensured by design; not production tested.

(4) Do not leave inputs floating; no internal pull-up/pull-down resistors.

PIN CONFIGURATION

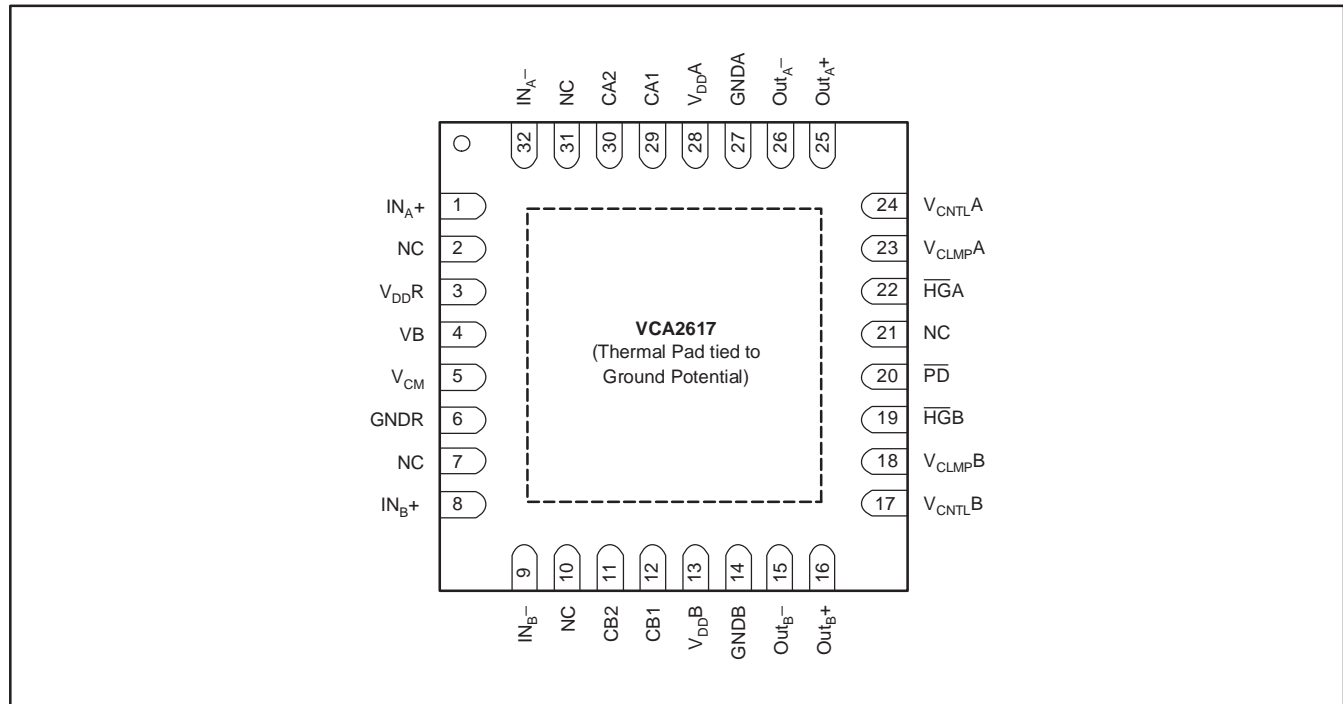

PIN DESCRIPTIONS

PIN	DESIGNATOR	DESCRIPTION	PIN	DESIGNATOR	DESCRIPTION
1	IN _A +	Channel A +Input	17	V _{CNTL} B	Channel B Gain Control Voltage Input
2	NC	No Internal Connection	18	V _{CLMP} B	Channel B Clamp Voltage
3	V _{DD} R	Reference Supply	19	HGB	Channel B High/Low Output Gain (High = Low Gain)
4	VB	Bias Voltage, 0.1μF Bypass Capacitor	20	PD	Power Down (Active High)
5	V _{CM}	Common-mode Voltage, 0.1μF Bypass Capacitor	21	NC	No Internal Connection
6	GNDR	Internal Reference Ground	22	HGA	Channel A High/Low Output Gain (High = Low Gain)
7	NC	No Internal Connection	23	V _{CLMP} A	Channel A Clamp Voltage
8	IN _B +	Channel B+ Input	24	V _{CNTL} A	Channel A Gain Control Voltage Input
9	IN _B -	Channel B- Input	25	Out _A +	Channel A+ Output
10	NC	No Internal Connection	26	Out _A -	Channel A- Output
11	CB2	Channel B, External Coupling Capacitor	27	GNDA	Channel A Ground
12	CB1	Channel B, External Coupling Capacitor	28	V _{DD} A	Channel A Supply
13	V _{DD} B	Channel B Supply	29	CA1	Channel A; External Coupling Capacitor
14	GNDB	Channel B Ground	30	CA2	Channel A; External Coupling Capacitor
15	Out _B -	Channel B- Output	31	NC	No Internal Connection
16	Out _B +	Channel B+ Output	32	IN _A -	Channel A- Input

TYPICAL CHARACTERISTICS

All specifications at $T_A = +25^\circ\text{C}$, $V_{DD} = 5\text{V}$, load resistance = 500Ω on each output to ground, differential output ($1V_{PP}$), CA, CB = $3.9\mu\text{F}$, single-ended input configuration, $f_{IN} = 5\text{MHz}$, HG = Low (High-Gain Mode), $V_{CNTL} = 2.3\text{V}$, unless otherwise noted.

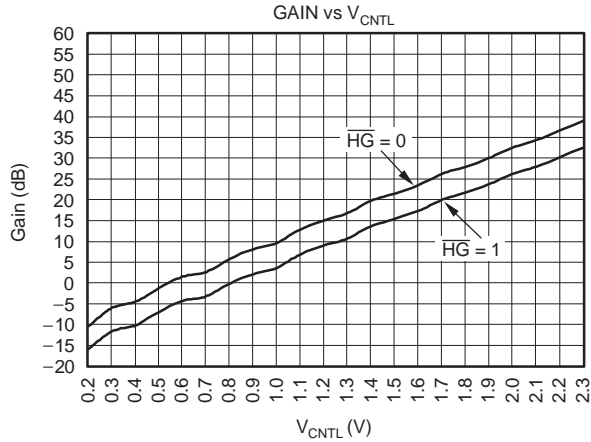

Figure 1

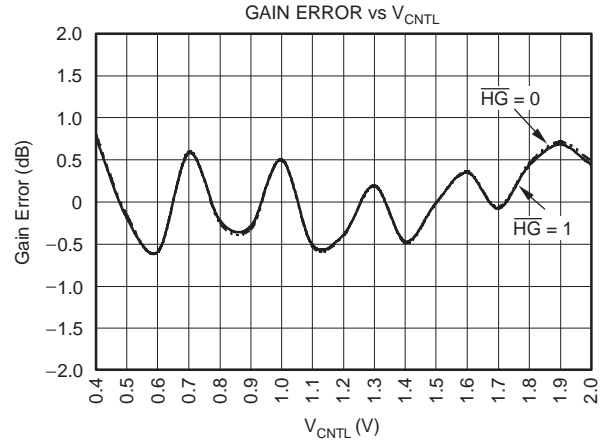

Figure 2

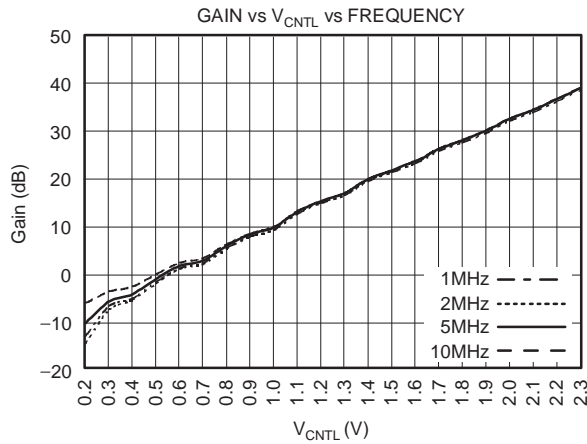

Figure 3

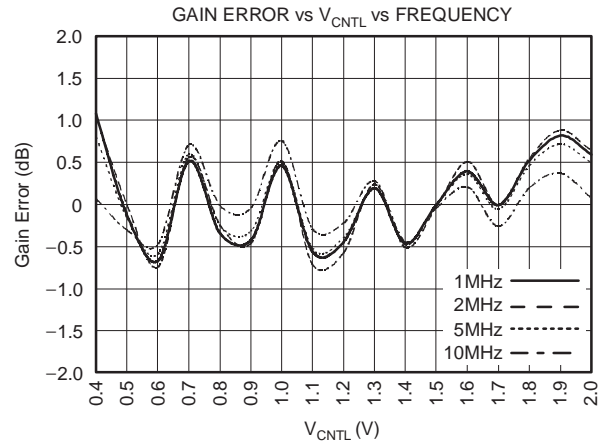

Figure 4

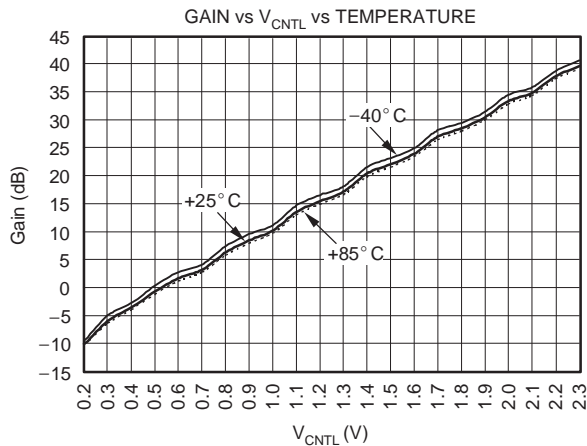

Figure 5

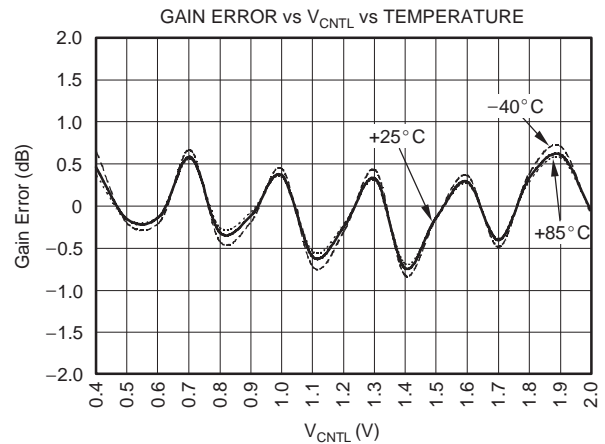

Figure 6

TYPICAL CHARACTERISTICS (continued)

All specifications at $T_A = +25^\circ\text{C}$, $V_{DD} = 5\text{V}$, load resistance = 500Ω on each output to ground, differential output (1V_{PP}), CA, CB = $3.9\mu\text{F}$, single-ended input configuration, $f_{IN} = 5\text{MHz}$, HG = Low (High-Gain Mode), $V_{CNTL} = 2.3\text{V}$, unless otherwise noted.

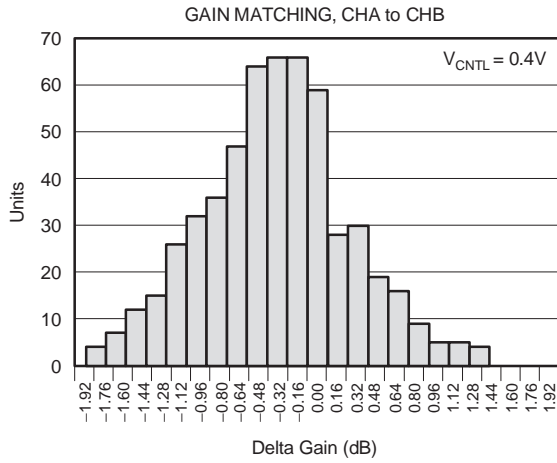

Figure 7

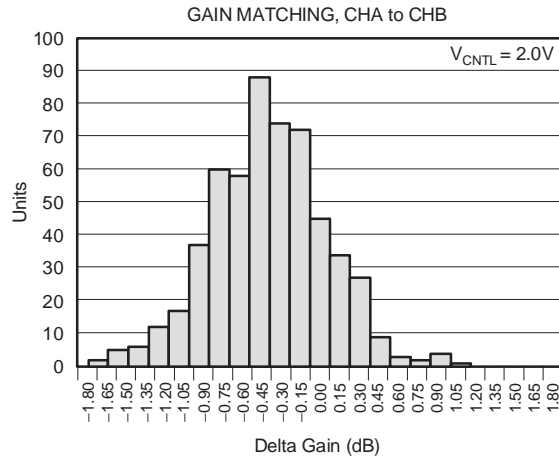

Figure 8

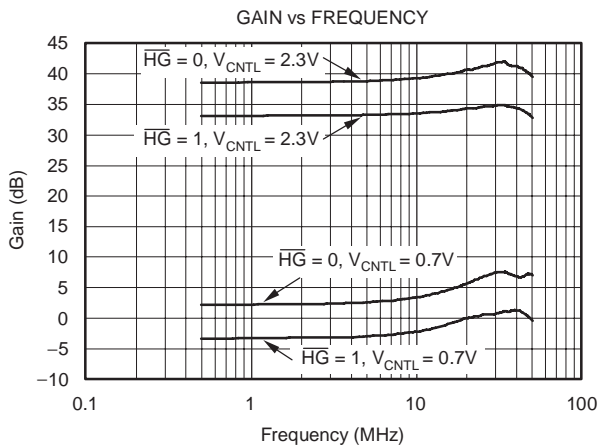

Figure 9

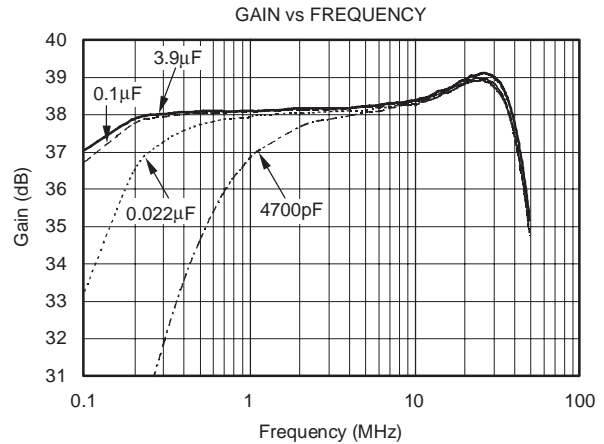

Figure 10

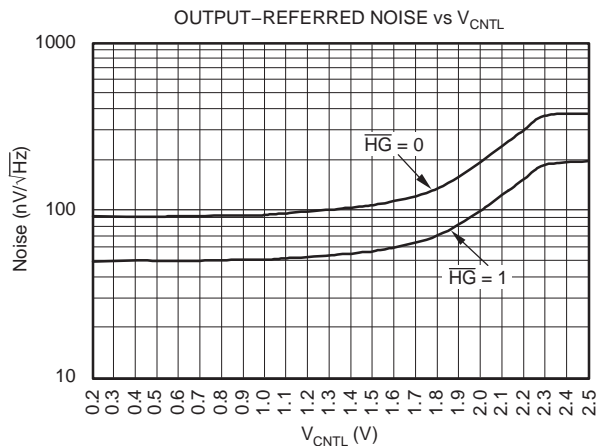

Figure 11

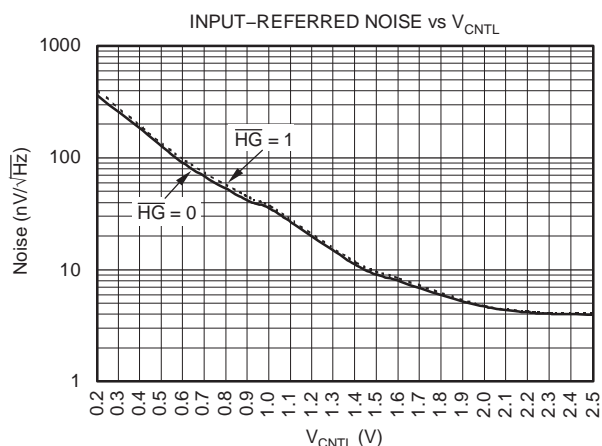

Figure 12

TYPICAL CHARACTERISTICS (continued)

All specifications at $T_A = +25^\circ\text{C}$, $V_{DD} = 5\text{V}$, load resistance = 500Ω on each output to ground, differential output (1V_{PP}), $C_A, C_B = 3.9\mu\text{F}$, single-ended input configuration, $f_{IN} = 5\text{MHz}$, $HG = \text{Low}$ (High-Gain Mode), $V_{CNTL} = 2.3\text{V}$, unless otherwise noted.

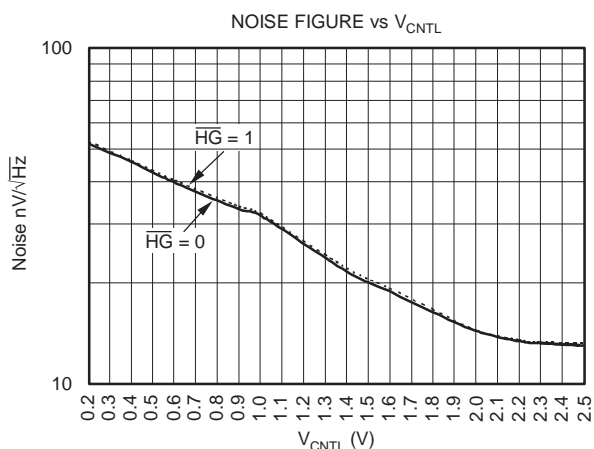

Figure 13

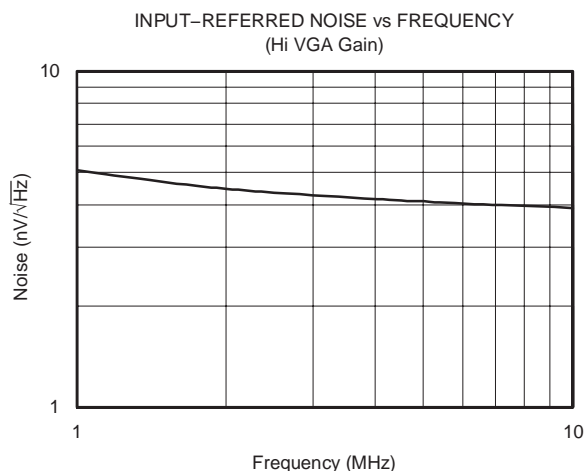

Figure 14

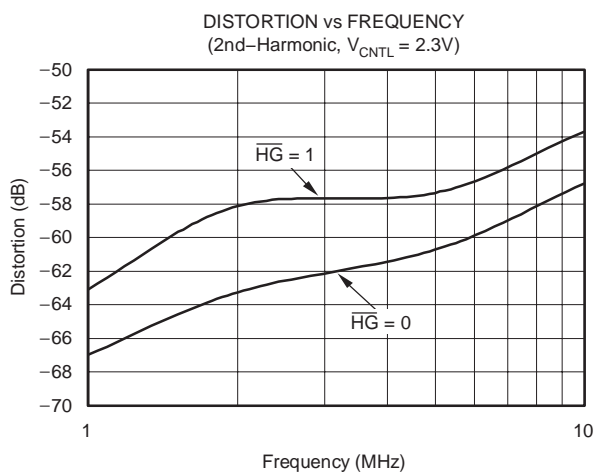

Figure 15

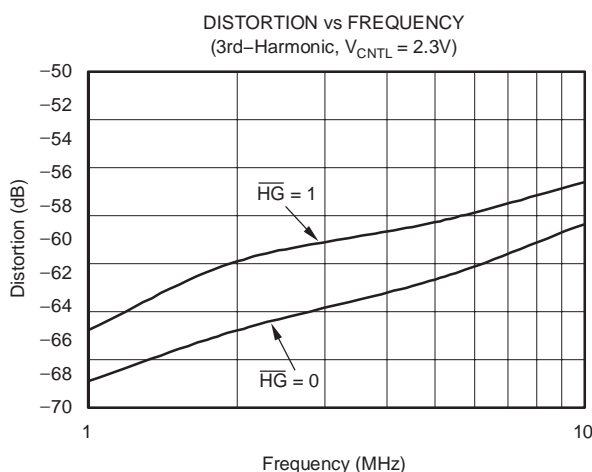

Figure 16

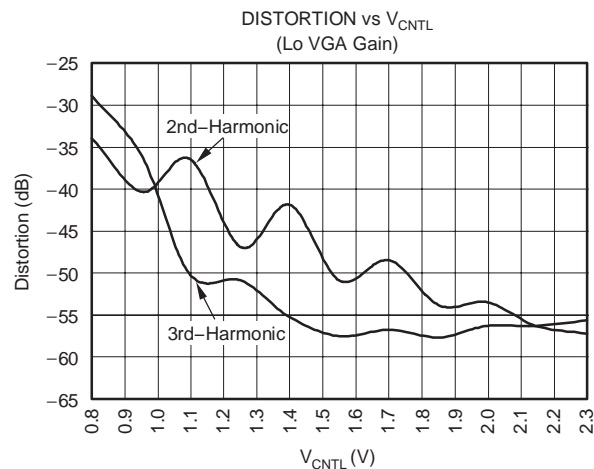

Figure 17

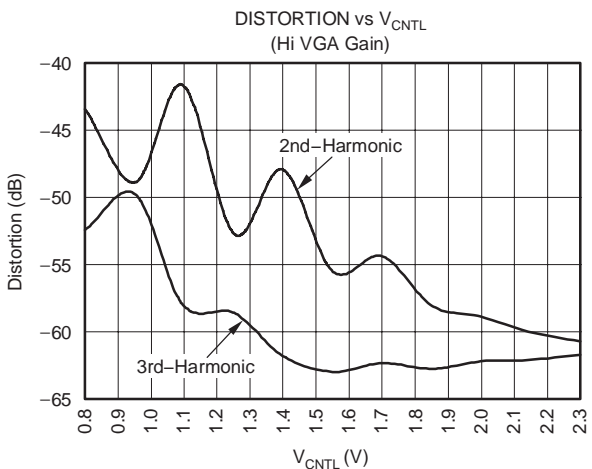

Figure 18

TYPICAL CHARACTERISTICS (continued)

All specifications at $T_A = +25^\circ\text{C}$, $V_{DD} = 5\text{V}$, load resistance = 500Ω on each output to ground, differential output (1V_{PP}), CA, CB = $3.9\mu\text{F}$, single-ended input configuration, $f_{IN} = 5\text{MHz}$, HG = Low (High-Gain Mode), $V_{CNTL} = 2.3\text{V}$, unless otherwise noted.

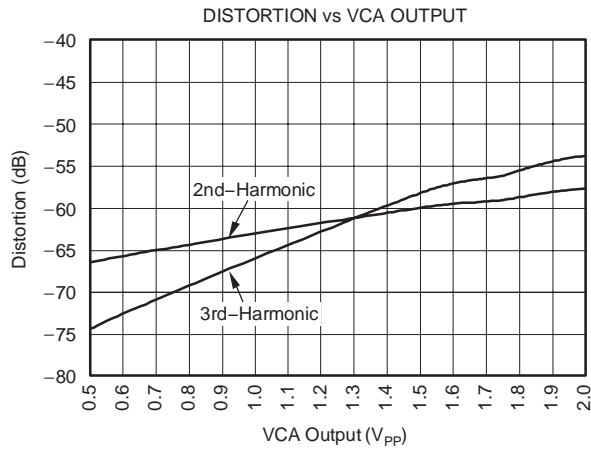

Figure 19

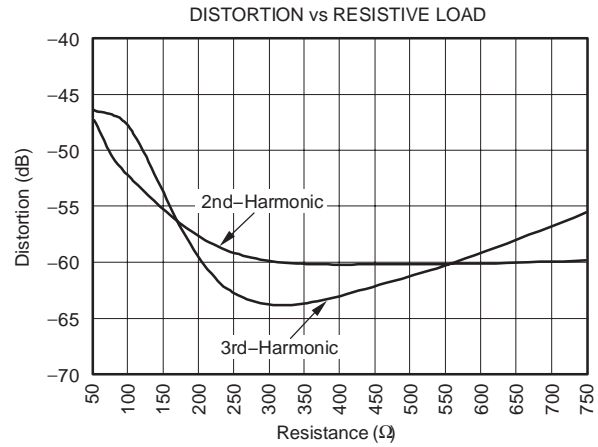

Figure 20

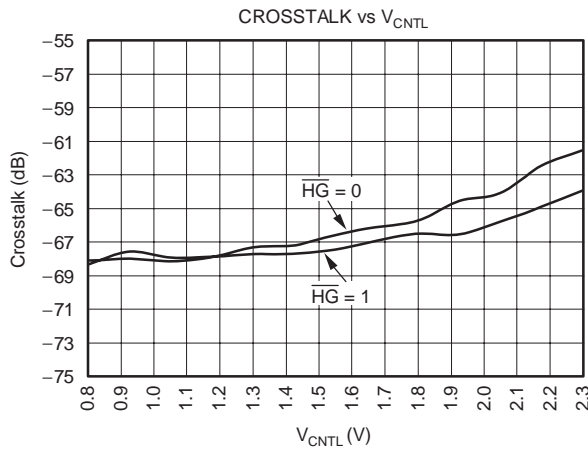

Figure 21

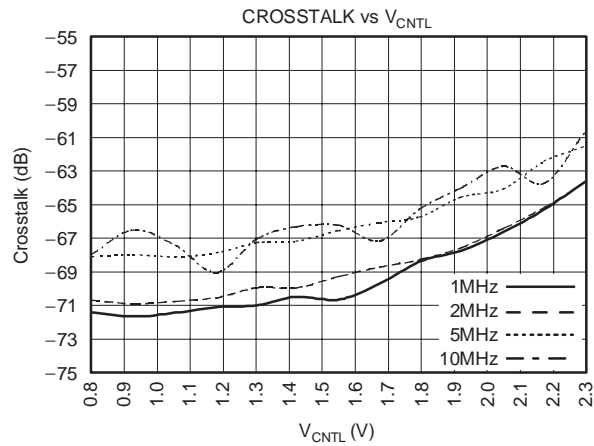

Figure 22

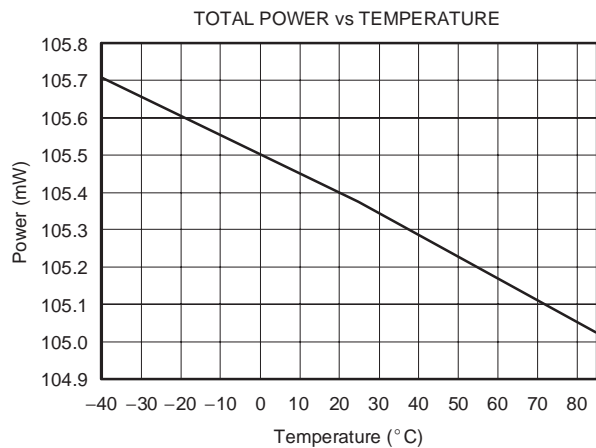

Figure 23

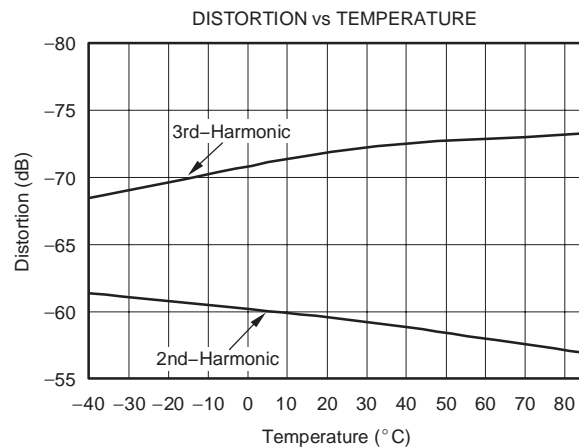

Figure 24

TYPICAL CHARACTERISTICS (continued)

All specifications at $T_A = +25^\circ\text{C}$, $V_{DD} = 5\text{V}$, load resistance = 500Ω on each output to ground, differential output (1V_{PP}), CA, CB = $3.9\mu\text{F}$, single-ended input configuration, $f_{IN} = 5\text{MHz}$, HG = Low (High-Gain Mode), $V_{CNTL} = 2.3\text{V}$, unless otherwise noted.

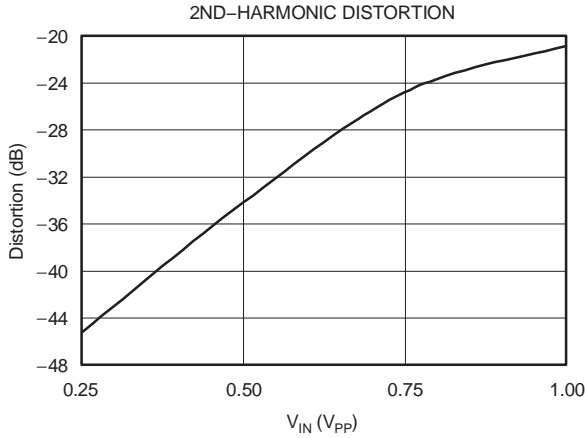

Figure 25

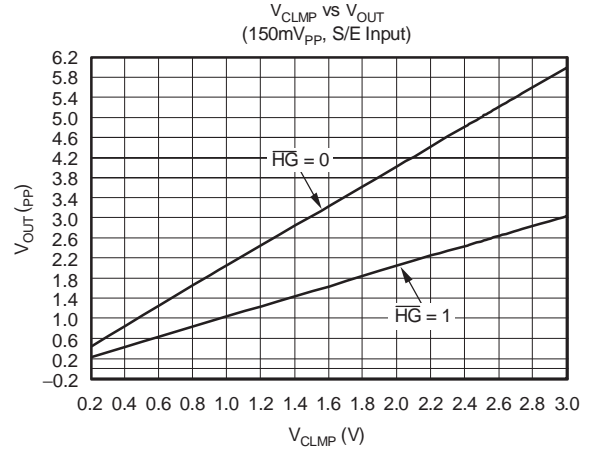

Figure 26

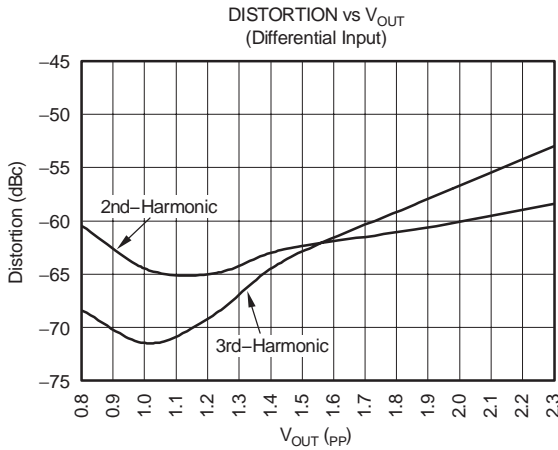

Figure 27

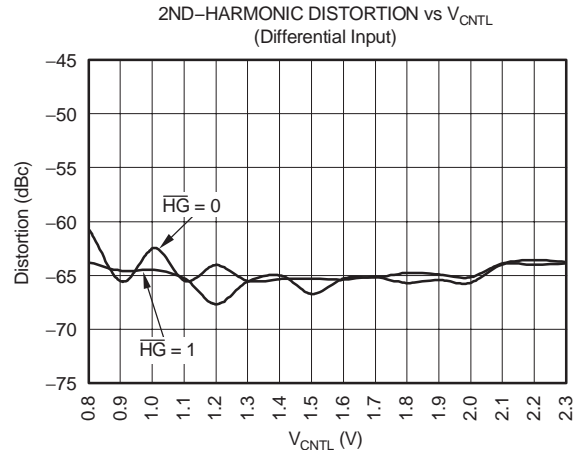

Figure 28

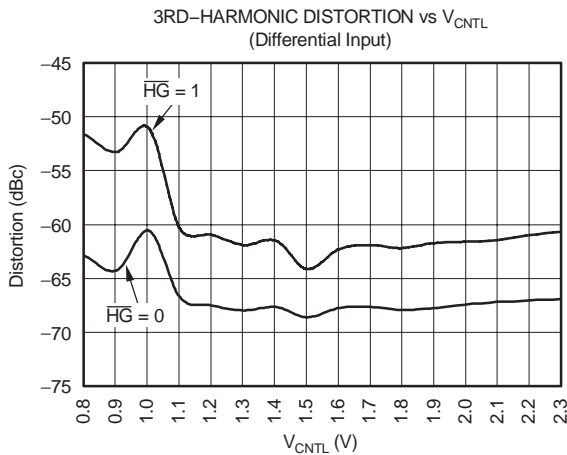

Figure 29

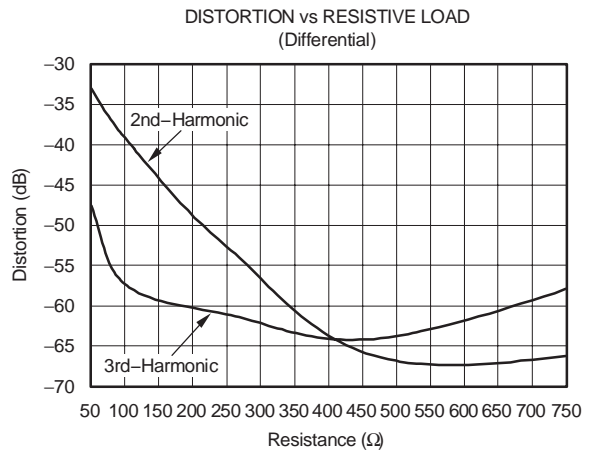

Figure 30

TYPICAL CHARACTERISTICS (continued)

All specifications at $T_A = +25^\circ\text{C}$, $V_{DD} = 5\text{V}$, load resistance = 500Ω on each output to ground, differential output (1V_{PP}), $C_A, C_B = 3.9\mu\text{F}$, single-ended input configuration, $f_{IN} = 5\text{MHz}$, $HG = \text{Low}$ (High-Gain Mode), $V_{CNTL} = 2.3\text{V}$, unless otherwise noted.

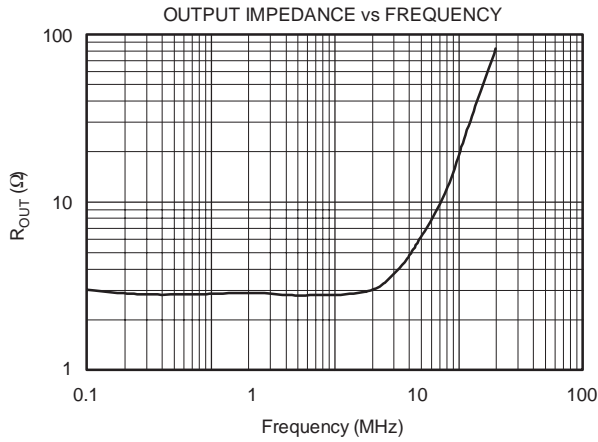

Figure 31

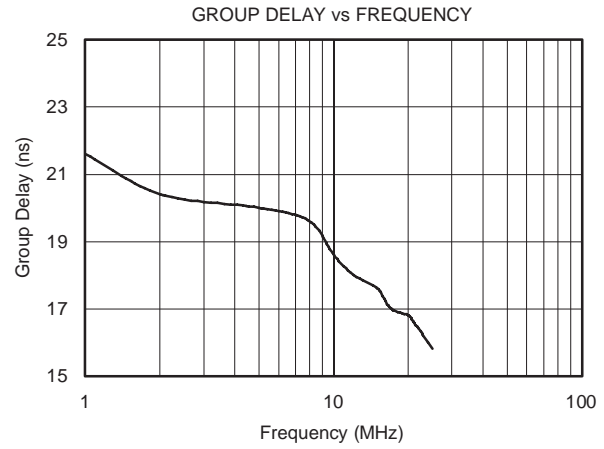

Figure 32

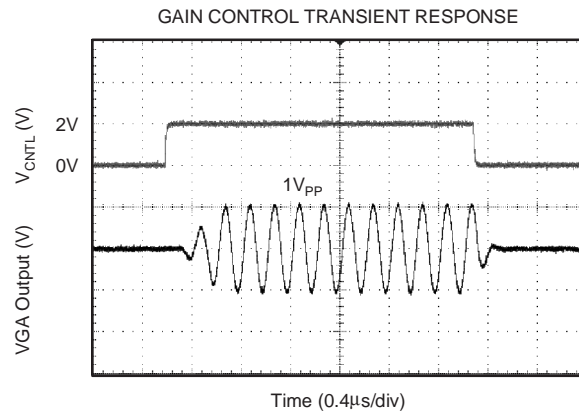

Figure 33

THEORY OF OPERATION

The VCA2617 is a dual-channel variable gain amplifier (VGA) with each channel being independent. The VGA is a true variable-gain amplifier, achieving lower noise output at lower gains. The output amplifier has two gains, allowing for further optimization with different analog-to-digital converters. Figure 34 shows a simplified block diagram of a single channel of the dual-channel system. The VGA can be powered down in order to conserve system power when necessary.

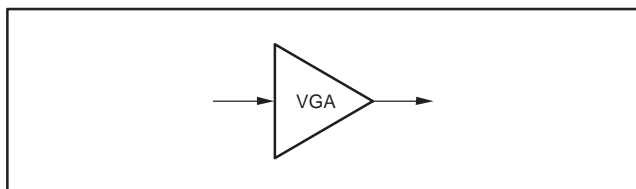

Figure 34. Simplified Block Diagram of VCA2617

VGA—OVERVIEW

The VGA that is used with the VCA2617 is a true variable-gain amplifier; as the gain is reduced, the noise contribution from the VGA itself is also reduced. This design is in contrast with another popular device architecture (used by the VCA2619), where an effective VCA characteristic is obtained by a voltage-variable attenuator succeeded by a fixed-gain amplifier. At the highest gain, systems with either architecture are dominated by the noise produced at the input to either the fixed or variable gain amplifier. At low gains, however, the noise output is dominated by the contribution from the VGA. Therefore, the overall system with lower VGA gain will produce less noise.

The following example will illustrate this point. Figure 34 shows a block diagram of the variable-gain amplifier; Figure 35 shows a block diagram of a variable attenuation attenuator followed by a fixed gain amplifier. For purposes of this example, let us assume the performance characteristics shown in Table 1; these values are the typical performance data of the VCA2617 and the VCA2619.

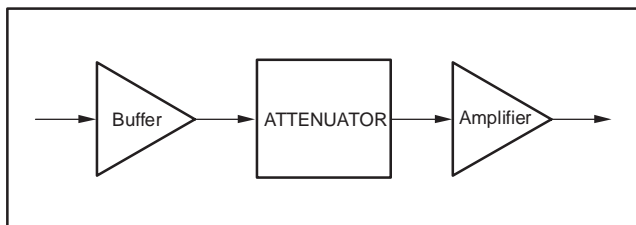

Figure 35. Block Diagram of Older VCA Models

Table 1. Gain and Noise Performance of Various VCA Blocks

BLOCK	GAIN (Loss) dB	NOISE nV/√Hz
Buffer	0	3.9
Attenuator (VCA2619)	0	2.2
Attenuator (VCA2619)	-40	2.2
VCA1 (VCA2617)	40	4.1
VCA1 (VCA2617)	0	90
VCA1 (VCA2619)	40	3.9

When the block diagram shown in Figure 34 has a gain of 40dB, the noise referred to the input (RTI) is:

$$\text{Total Noise (RTI)} = 4.1\text{nV}/\sqrt{\text{Hz}} \quad (1)$$

When the block diagram shown in Figure 35 has the combined gain of 60dB, the noise referred to the input (RTI) is given by the expression:

$$\begin{aligned} \text{Total Noise (RTI)} &= \\ &= \sqrt{(\text{Buffer Noise})^2 + (\text{ATTEN Noise})^2 + (\text{VCA Noise})^2} \\ &= \sqrt{(3.9)^2 + (2.2)^2 + (3.9)^2} = 5.9\text{nV}/\sqrt{\text{Hz}} \end{aligned} \quad (2)$$

Repeating the above measurements for both VCA configurations when the overall gain is 10dB yields the following results:

For the VCA with a variable gain amplifier (Figure 34):

$$\text{Total Noise (RTI)} = 90\text{nV}/\sqrt{\text{Hz}} \quad (3)$$

For the VCA with a variable attenuation attenuator (Figure 35):

$$\begin{aligned} \text{Total Noise} &= \sqrt{(3.9)^2 + (2.2)^2 + (2.0/0.10)^2} \\ &= 14\text{nV}/\sqrt{\text{Hz}} \end{aligned} \quad (4)$$

The VGA has a continuously-variable gain range of 48dB with the ability to select either of two options. The gain of the VGA can either be varied from -10dB to 38dB, or from -16dB to 32dB. The VGA output can be programmed to clip at a predetermined voltage that is selected by the user. When the user applies a voltage to the V_{CLMP} -pin, the output will have a peak-to-peak voltage that is given by the graph shown in Figure 26.

**VOLTAGE-CONTROLLED AMPLIFIER (VCA)—
DETAIL**

Figure 36 shows a simplified schematic of the VCA. The VCA2617 is a true voltage-controlled amplifier, with the gain expressed in dB directly proportional to a control signal. This architecture compares to the older VCA products where a voltage-controlled attenuator was followed by a fixed-gain amplifier. With a variable-gain amplifier, the output noise diminishes as the gain reduces. A variable-gain amplifier, where the output amplifier gain

is fixed, will not show diminished noise in this manner. Refer to Table 2, which shows a comparison between the noise performance at different gains for the VCA2617 and the older VCA2619.

Table 2. Noise vs Gain ($R_G = 0$)

PRODUCT	GAIN (dB)	NOISE RTI (nV/√Hz)
VCA2617	40	4.1
VCA2617	0	100
VCA2619	40	5.9
VCA2619	0	500

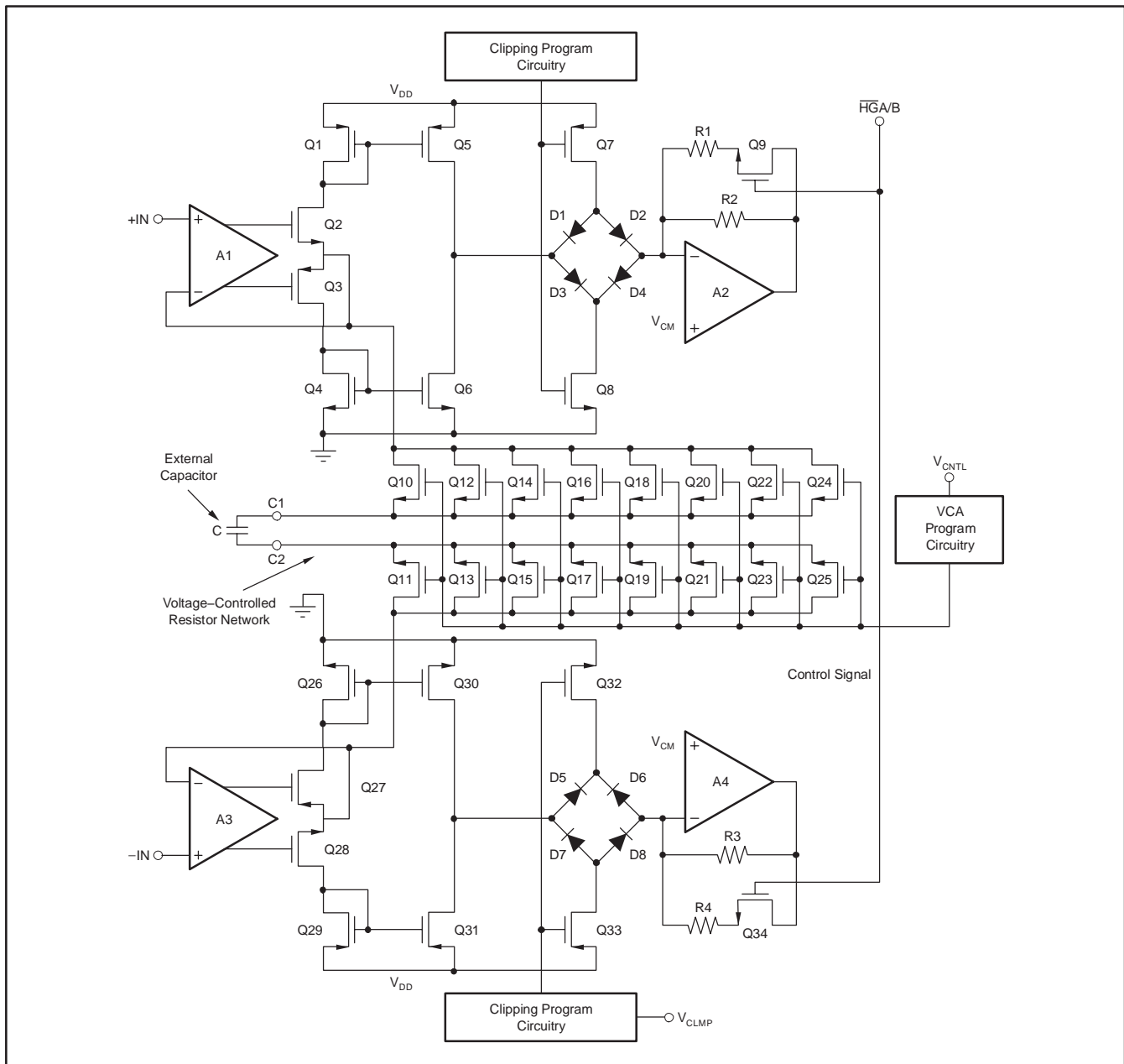

Figure 36. Block Diagram of VCA

The VCA accepts a differential input at the +IN and –IN terminals. Amplifier A1, along with transistors Q2 and Q3, forms a voltage follower that buffers the +IN signal to be able to drive the voltage-controlled resistor. Amplifier A3, along with transistors Q27 and Q28, plays the same role as A1. The differential signal applied to the voltage-controlled resistor network is converted to a current that flows through transistors Q1 through Q4. Through the mirror action of transistors Q1/Q5 and Q4/Q6, a copy of this same current flows through Q5 and Q6. Assuming that the signal current is less than the programmed clipping current (that is, the current flowing through transistors Q7 and Q8), the signal current will then go through the diode bridge (D1 through D4) and be sent through either R2 or R1, depending upon the state of Q9. This signal current multiplied by the feedback resistor associated with amplifier A2, determines the signal voltage that is designated –OUT. Operation of the circuitry associated with A3 and A4 is identical to the operation of the previously described function to create the signal +OUT.

A1 and its circuitry form a voltage-to-current converter, while A2 and its circuitry form a current-to-voltage converter. This architecture was adapted because it has excellent signal-handling capability. A1 has been designed to handle a large voltage signal without overloading, and the various mirroring devices have also been sized to handle large currents. Good overload capability is achieved as both the input and output amplifier are not required to amplify voltage signals. Voltage amplification occurs when the input voltage is converted to a current; this current in turn is converted back to a voltage as amplifier A2 acts as a transimpedance amplifier. The overall gain of the output amplifier A2 can be altered by 6dB by the action of the \overline{HG} signal. This enables more optimum performance when the VCA interfaces with either a 10-bit or 12-bit analog-to-digital converter (ADC). An external capacitor (C) is required to provide a low impedance connection to join the two sections of the resistor network. Capacitor C could be replaced by a short-circuit. By providing a DC connection, the output offset will be a function of the gain setting. Typically, the offset at this point is $\pm 10\text{mV}$; thus, if the gain varies from 1 to 100, the output offset would vary from $\pm 10\text{mV}$ to $\pm 100\text{mV}$.

VARIABLE GAIN CHARACTERISTICS

Transistors Q10, Q12, Q14, Q16, Q18, Q20, Q22, and Q24 form a variable resistor network that is programmed in an exponential manner to control the gain. Transistors Q11, Q13, Q15, Q17, Q19, Q21, Q23, and Q25 perform the same function. These two groups of FET variable resistors are configured in this manner to balance the capacitive loading on the total variable-resistor network. This

balanced configuration is used to keep the second harmonic component of the distortion low. The common source connection associated with each group of FET variable resistors is brought out to an external pin so that an external capacitor can be used to make an AC connection. This connection is necessary to achieve an adequate low-frequency bandwidth because the coupling capacitor would be too large to include within the monolithic chip. The value of this variable resistor ranges in value from 15Ω to 5000Ω to achieve a gain range of about 48dB. The low-frequency bandwidth is then given by the formula:

$$\text{Low Frequency BW} = 1/2\pi RC \quad (5)$$

where:

R is the value of the attenuator.

C is the value of the external coupling capacitor.

For example, if a low-frequency bandwidth of 500kHz was desired and the value of R was 10Ω , then the value of the coupling capacitor would be $0.05\mu\text{F}$.

One of the benefits of this method of gain control is that the output offset is independent of the variable gain of the output amplifier. The DC gain of the output amplifier is extremely low; any change in the input voltage is blocked by the coupling capacitor, and no signal current flows through the variable resistor. This method also means that any offset voltage existing in the input is stored across this coupling capacitor; when the resistor value is changed, the DC output will not change. Therefore, changes in the control voltage do not appear in the output signal. Figure 37 shows the output waveform resulting from a step change in the control voltage, and Figure 38 shows the output voltage resulting when the control voltage is a full-scale ramp.

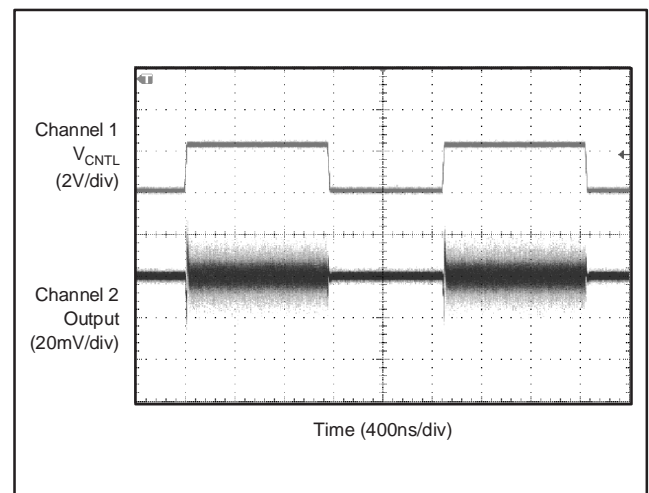

Figure 37. Response to Step Change of V_{CNTL}

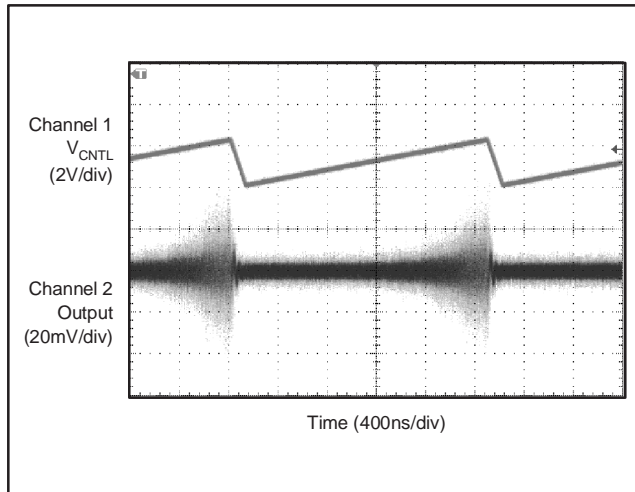

Figure 38. Response to Ramp Change of V_{CNTL}

The exponential gain control characteristic is achieved through a piecewise approximation to a perfectly smooth exponential curve. Eight FETs, operated as variable resistors whose value is progressively 1/2 of the value of the adjacent parallel FET, are turned on progressively, or their value is lowered to create the exponential gain characteristic. This characteristic can be shown in the following way. An exponential such as $y = e^x$ increases in the y dimension by a constant ratio as the x dimension increases by a constant linear amount. In other words, for a constant $(x_1 - x_2)$, the ratio e^{x_1}/e^{x_2} remains the same.

When FETs used as variable resistors are placed in parallel, the attenuation characteristic that is created behaves according to this same exponential characteristic at discrete points as a function of the control voltage. It does not perfectly obey an ideal exponential characteristic at other points; however, an 8-section approximation yields a ± 1 dB error to an ideal curve.

PROGRAMMABLE CLIPPING

The clipping level of the VCA2617 can be programmed to a desired output. The programming feature is useful when matching the clipped level from the output of the VCA to the full-scale range of a subsequent VCA, in order to prevent the VCA from generating false spectral signals; see the circuit diagram shown in Figure 39. The signal node at the drain junction of Q5 and Q6 is sent to the diode bridge formed by diode-connected transistors, D1 through D4. The diode bridge output is determined by the current that flows through transistors Q7 and Q8. The maximum current that can then flow into the summing node of A2 is this same current; consequently, the maximum voltage output of A2 is this same current multiplied by the feedback resistor associated with A2. The maximum output voltage of A2, which would be the clipped output, can then be controlled by adjusting the current that flows through Q7 and Q8; see the circuit diagram shown in Figure 36. The circuitry of A1, R1, and Q1 converts the clamp voltage (V_{CLMP}) to a current that controls equal and opposite currents flowing through transistors Q5 and Q6.

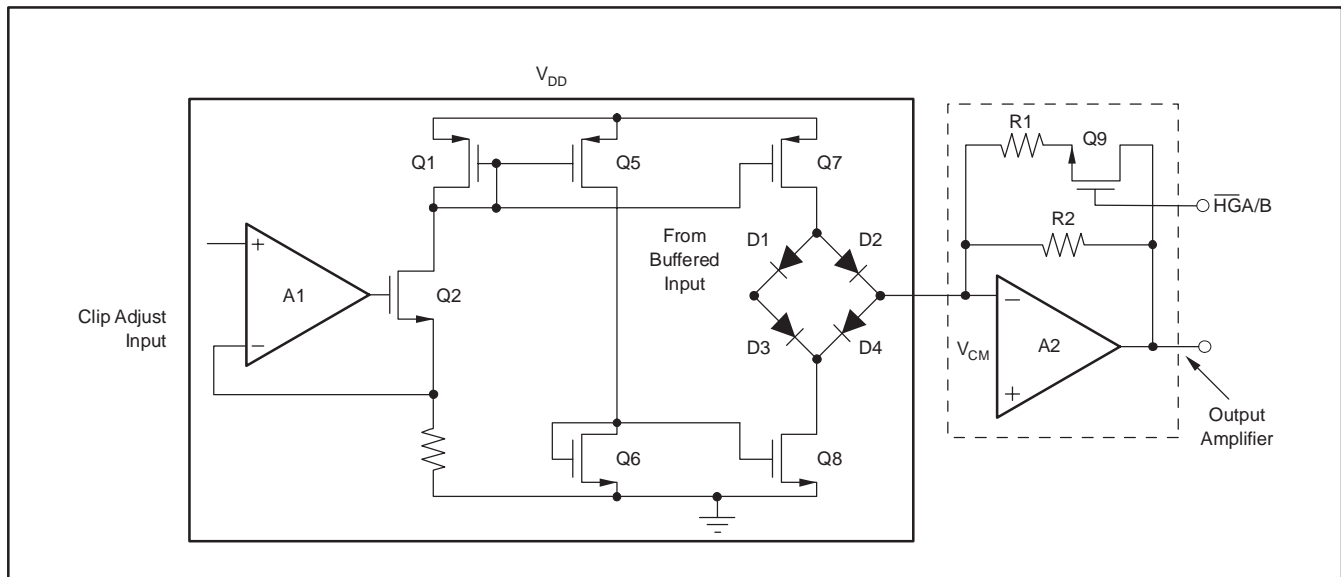

Figure 39. Clipping Level Adjust Circuitry

When $\overline{HG} = 0$, the previously described circuitry is designed so that the value of the V_{CLMP} signal is equal to the peak differential signal developed between $+V_{OUT}$ and $-V_{OUT}$. When $\overline{HG} = 1$, the differential output will be equal to the clamp voltage. This method of controlled clipping also achieves fast and clean settling waveforms at the output of the VCA, as shown in Figure 40 through Figure 43. The sequence of waveforms demonstrate the clipping performance during various stages of overload.

In a typical application, the VCA2617 will drive an anti-aliasing filter, which in turn will drive an ADC. Many modern ADCs, such as the ADS5270, are well-behaved with as much as 2x overload. This means that the clipping level of the VCA should be set to overcome the loss in the filter such that the clipped input to the ADC is just slightly over the full-scale input. By setting the clipping level in this manner, the lowest harmonic distortion level will be achieved without interfering with the overload capability of the ADC.

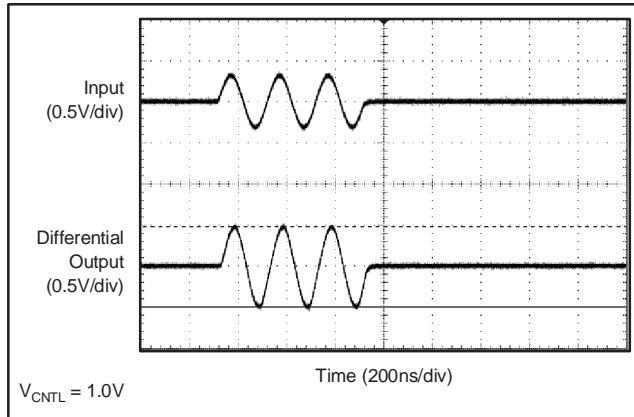

Figure 40. Before Overload (630mV_{pp} Input)

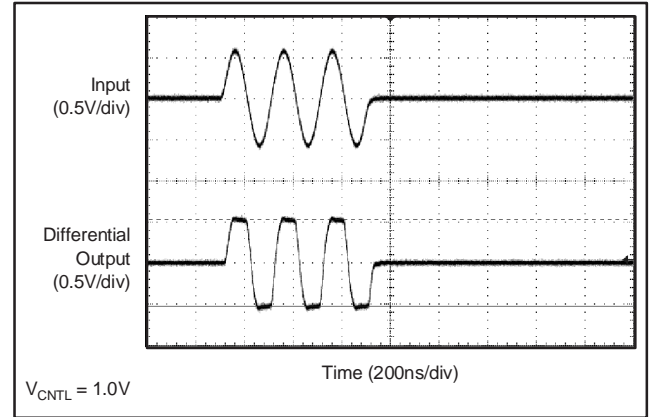

Figure 42. Overload (1.5V_{pp} Input)

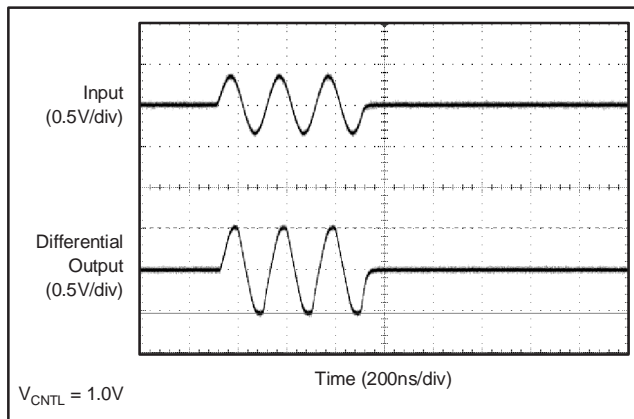

Figure 41. Approaching Overload (700mV_{pp} Input)

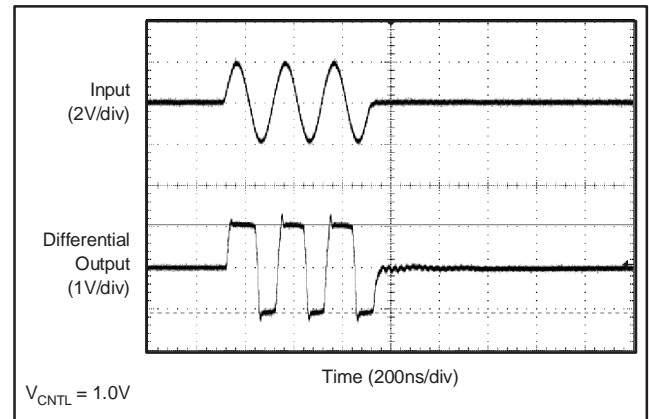

Figure 43. Extreme Overload (3.8V_{pp} Input)

PACKAGING INFORMATION

Orderable Device	Status (1)	Package Type	Package Drawing	Pins	Package Qty	Eco Plan (2)	Lead/Ball Finish	MSL Peak Temp (3)	Op Temp (°C)	Top-Side Markings (4)	Samples
VCA2617RHBR	ACTIVE	QFN	RHB	32	3000	Green (RoHS & no Sb/Br)	CU NIPDAU	Level-2-260C-1 YEAR	-40 to 85	VCA 2617	Samples
VCA2617RHBRG4	ACTIVE	QFN	RHB	32	3000	Green (RoHS & no Sb/Br)	CU NIPDAU	Level-2-260C-1 YEAR	-40 to 85	VCA 2617	Samples
VCA2617RHBT	ACTIVE	QFN	RHB	32	250	Green (RoHS & no Sb/Br)	CU NIPDAU	Level-2-260C-1 YEAR	-40 to 85	VCA 2617	Samples
VCA2617RHBTG4	ACTIVE	QFN	RHB	32	250	Green (RoHS & no Sb/Br)	CU NIPDAU	Level-2-260C-1 YEAR	-40 to 85	VCA 2617	Samples

(1) The marketing status values are defined as follows:

ACTIVE: Product device recommended for new designs.

LIFEBUY: TI has announced that the device will be discontinued, and a lifetime-buy period is in effect.

NRND: Not recommended for new designs. Device is in production to support existing customers, but TI does not recommend using this part in a new design.

PREVIEW: Device has been announced but is not in production. Samples may or may not be available.

OBSOLETE: TI has discontinued the production of the device.

(2) Eco Plan - The planned eco-friendly classification: Pb-Free (RoHS), Pb-Free (RoHS Exempt), or Green (RoHS & no Sb/Br) - please check <http://www.ti.com/productcontent> for the latest availability information and additional product content details.

TBD: The Pb-Free/Green conversion plan has not been defined.

Pb-Free (RoHS): TI's terms "Lead-Free" or "Pb-Free" mean semiconductor products that are compatible with the current RoHS requirements for all 6 substances, including the requirement that lead not exceed 0.1% by weight in homogeneous materials. Where designed to be soldered at high temperatures, TI Pb-Free products are suitable for use in specified lead-free processes.

Pb-Free (RoHS Exempt): This component has a RoHS exemption for either 1) lead-based flip-chip solder bumps used between the die and package, or 2) lead-based die adhesive used between the die and leadframe. The component is otherwise considered Pb-Free (RoHS compatible) as defined above.

Green (RoHS & no Sb/Br): TI defines "Green" to mean Pb-Free (RoHS compatible), and free of Bromine (Br) and Antimony (Sb) based flame retardants (Br or Sb do not exceed 0.1% by weight in homogeneous material)

(3) MSL, Peak Temp. -- The Moisture Sensitivity Level rating according to the JEDEC industry standard classifications, and peak solder temperature.

(4) Only one of markings shown within the brackets will appear on the physical device.

Important Information and Disclaimer: The information provided on this page represents TI's knowledge and belief as of the date that it is provided. TI bases its knowledge and belief on information provided by third parties, and makes no representation or warranty as to the accuracy of such information. Efforts are underway to better integrate information from third parties. TI has taken and continues to take reasonable steps to provide representative and accurate information but may not have conducted destructive testing or chemical analysis on incoming materials and chemicals. TI and TI suppliers consider certain information to be proprietary, and thus CAS numbers and other limited information may not be available for release.

In no event shall TI's liability arising out of such information exceed the total purchase price of the TI part(s) at issue in this document sold by TI to Customer on an annual basis.

MECHANICAL DATA

RHB (S-PVQFN-N32)

PLASTIC QUAD FLATPACK NO-LEAD



- NOTES:
- All linear dimensions are in millimeters. Dimensioning and tolerancing per ASME Y14.5M-1994.
 - This drawing is subject to change without notice.
 - QFN (Quad Flatpack No-Lead) Package configuration.
 - The package thermal pad must be soldered to the board for thermal and mechanical performance.
 - See the additional figure in the Product Data Sheet for details regarding the exposed thermal pad features and dimensions.
 - Falls within JEDEC MO-220.

THERMAL INFORMATION

This package incorporates an exposed thermal pad that is designed to be attached directly to an external heatsink. The thermal pad must be soldered directly to the printed circuit board (PCB). After soldering, the PCB can be used as a heatsink. In addition, through the use of thermal vias, the thermal pad can be attached directly to the appropriate copper plane shown in the electrical schematic for the device, or alternatively, can be attached to a special heatsink structure designed into the PCB. This design optimizes the heat transfer from the integrated circuit (IC).

For information on the Quad Flatpack No-Lead (QFN) package and its advantages, refer to Application Report, QFN/SON PCB Attachment, Texas Instruments Literature No. SLUA271. This document is available at www.ti.com.

The exposed thermal pad dimensions for this package are shown in the following illustration.

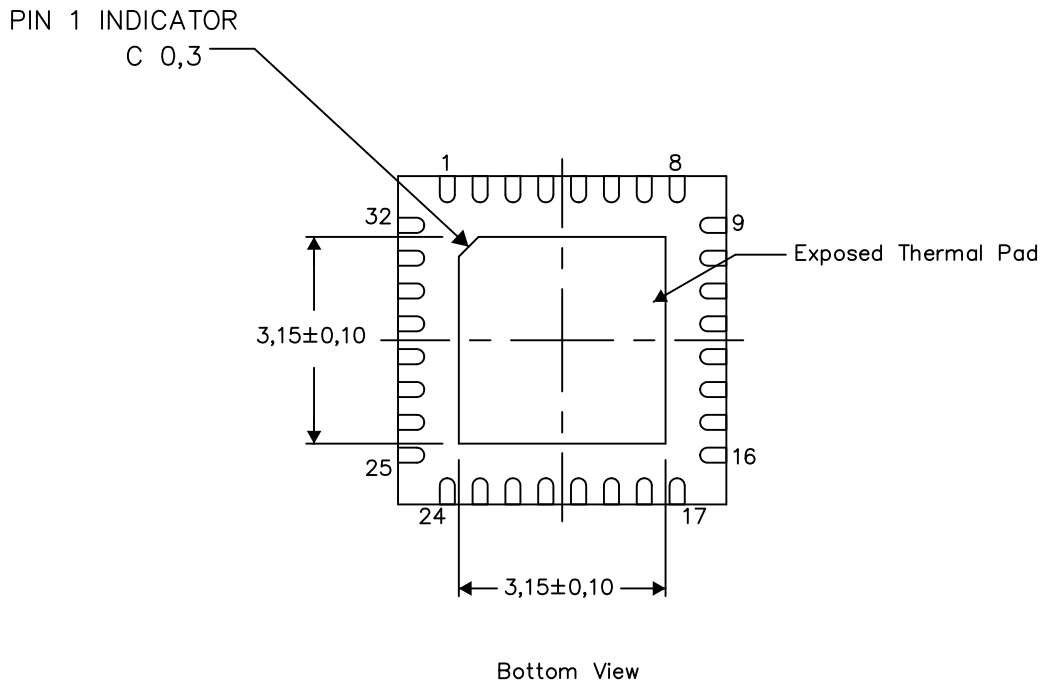

Exposed Thermal Pad Dimensions

4206356-3/X 12/12

NOTE: A. All linear dimensions are in millimeters

RHB (S-PVQFN-N32)

PLASTIC QUAD FLATPACK NO-LEAD

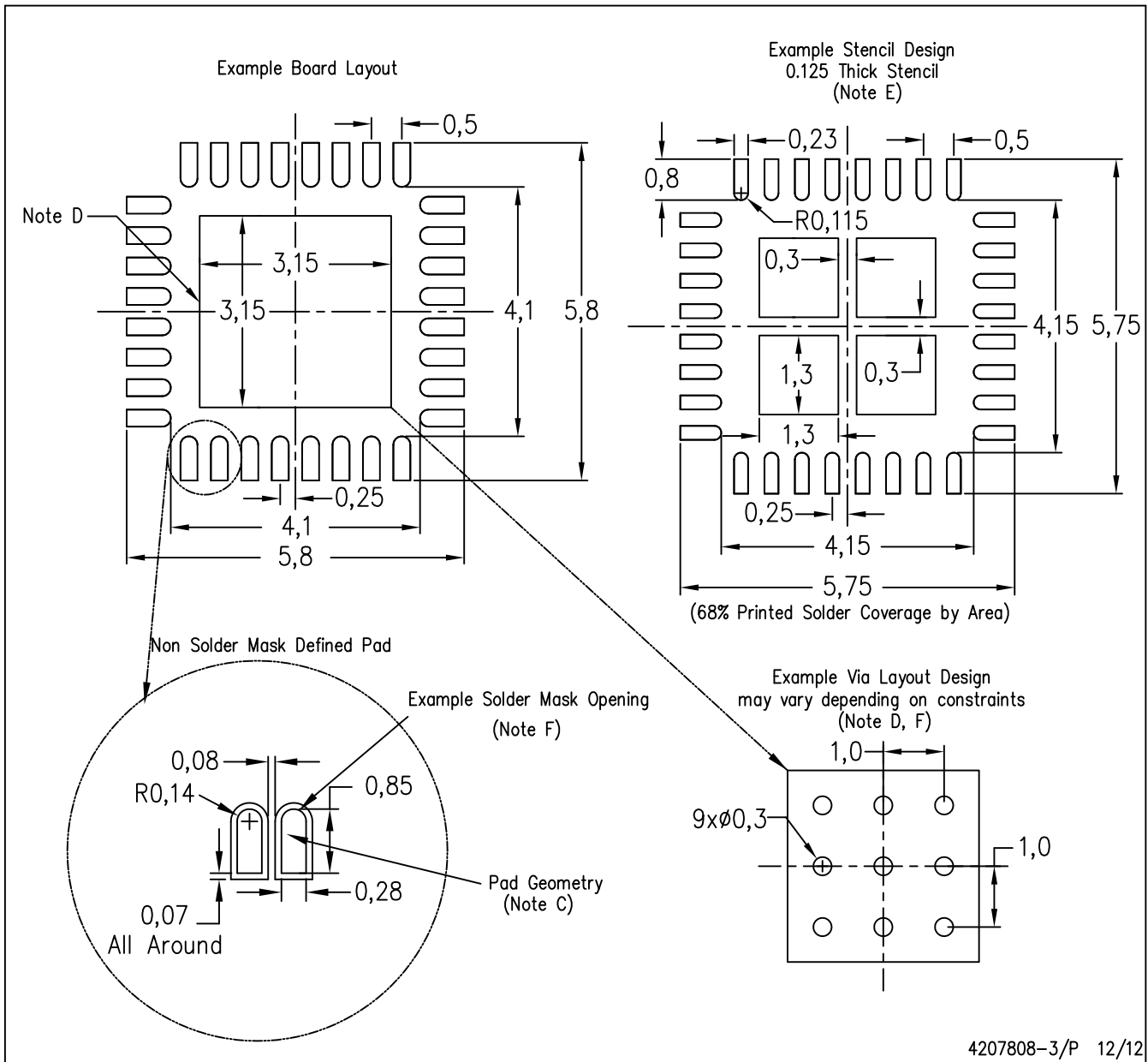

- NOTES:
- All linear dimensions are in millimeters.
 - This drawing is subject to change without notice.
 - Publication IPC-7351 is recommended for alternate designs.
 - This package is designed to be soldered to a thermal pad on the board. Refer to Application Note, Quad Flat-Pack Packages, Texas Instruments Literature No. SLUA271, and also the Product Data Sheets for specific thermal information, via requirements, and recommended board layout. These documents are available at www.ti.com <<http://www.ti.com>>.
 - Laser cutting apertures with trapezoidal walls and also rounding corners will offer better paste release. Customers should contact their board assembly site for stencil design recommendations. Refer to IPC 7525 for stencil design considerations.
 - Customers should contact their board fabrication site for recommended solder mask tolerances and via tenting recommendations for vias placed in the thermal pad.

IMPORTANT NOTICE

Texas Instruments Incorporated and its subsidiaries (TI) reserve the right to make corrections, enhancements, improvements and other changes to its semiconductor products and services per JESD46, latest issue, and to discontinue any product or service per JESD48, latest issue. Buyers should obtain the latest relevant information before placing orders and should verify that such information is current and complete. All semiconductor products (also referred to herein as "components") are sold subject to TI's terms and conditions of sale supplied at the time of order acknowledgment.

TI warrants performance of its components to the specifications applicable at the time of sale, in accordance with the warranty in TI's terms and conditions of sale of semiconductor products. Testing and other quality control techniques are used to the extent TI deems necessary to support this warranty. Except where mandated by applicable law, testing of all parameters of each component is not necessarily performed.

TI assumes no liability for applications assistance or the design of Buyers' products. Buyers are responsible for their products and applications using TI components. To minimize the risks associated with Buyers' products and applications, Buyers should provide adequate design and operating safeguards.

TI does not warrant or represent that any license, either express or implied, is granted under any patent right, copyright, mask work right, or other intellectual property right relating to any combination, machine, or process in which TI components or services are used. Information published by TI regarding third-party products or services does not constitute a license to use such products or services or a warranty or endorsement thereof. Use of such information may require a license from a third party under the patents or other intellectual property of the third party, or a license from TI under the patents or other intellectual property of TI.

Reproduction of significant portions of TI information in TI data books or data sheets is permissible only if reproduction is without alteration and is accompanied by all associated warranties, conditions, limitations, and notices. TI is not responsible or liable for such altered documentation. Information of third parties may be subject to additional restrictions.

Resale of TI components or services with statements different from or beyond the parameters stated by TI for that component or service voids all express and any implied warranties for the associated TI component or service and is an unfair and deceptive business practice. TI is not responsible or liable for any such statements.

Buyer acknowledges and agrees that it is solely responsible for compliance with all legal, regulatory and safety-related requirements concerning its products, and any use of TI components in its applications, notwithstanding any applications-related information or support that may be provided by TI. Buyer represents and agrees that it has all the necessary expertise to create and implement safeguards which anticipate dangerous consequences of failures, monitor failures and their consequences, lessen the likelihood of failures that might cause harm and take appropriate remedial actions. Buyer will fully indemnify TI and its representatives against any damages arising out of the use of any TI components in safety-critical applications.

In some cases, TI components may be promoted specifically to facilitate safety-related applications. With such components, TI's goal is to help enable customers to design and create their own end-product solutions that meet applicable functional safety standards and requirements. Nonetheless, such components are subject to these terms.

No TI components are authorized for use in FDA Class III (or similar life-critical medical equipment) unless authorized officers of the parties have executed a special agreement specifically governing such use.

Only those TI components which TI has specifically designated as military grade or "enhanced plastic" are designed and intended for use in military/aerospace applications or environments. Buyer acknowledges and agrees that any military or aerospace use of TI components which have **not** been so designated is solely at the Buyer's risk, and that Buyer is solely responsible for compliance with all legal and regulatory requirements in connection with such use.

TI has specifically designated certain components as meeting ISO/TS16949 requirements, mainly for automotive use. In any case of use of non-designated products, TI will not be responsible for any failure to meet ISO/TS16949.

Products

Audio	www.ti.com/audio
Amplifiers	amplifier.ti.com
Data Converters	dataconverter.ti.com
DLP® Products	www.dlp.com
DSP	dsp.ti.com
Clocks and Timers	www.ti.com/clocks
Interface	interface.ti.com
Logic	logic.ti.com
Power Mgmt	power.ti.com
Microcontrollers	microcontroller.ti.com
RFID	www.ti-rfid.com
OMAP Applications Processors	www.ti.com/omap
Wireless Connectivity	www.ti.com/wirelessconnectivity

Applications

Automotive and Transportation	www.ti.com/automotive
Communications and Telecom	www.ti.com/communications
Computers and Peripherals	www.ti.com/computers
Consumer Electronics	www.ti.com/consumer-apps
Energy and Lighting	www.ti.com/energy
Industrial	www.ti.com/industrial
Medical	www.ti.com/medical
Security	www.ti.com/security
Space, Avionics and Defense	www.ti.com/space-avionics-defense
Video and Imaging	www.ti.com/video

TI E2E Community

e2e.ti.com