

## 8-Channel, Ultralow-Power, Variable Gain Amplifier with Low-Noise Pre-Amp

### FEATURES

- **Ultralow Power: 65mW/Channel**
- **Low Noise:  $0.8nV/\sqrt{Hz}$**
- **Low-Noise Pre-Amp (LNP):**
  - 20dB Fixed Gain
  - 250mV<sub>pp</sub> Linear Input Range
- **Variable Gain Amplifier:**
  - Gain Control Range: 46dB
  - Selectable PGA Gain: 20dB, 25dB, 27dB, 30dB
  - Fast Overload Recovery
  - Output Clamping Control
- **Integrated Low-Pass Filter:**
  - Second-Order, Linear Phase
  - Bandwidth: 10MHz, 15MHz
- **High Accuracy:**
  - Low Gain Error:  $\pm 0.5dB$
  - Excellent Channel Matching:  $\pm 0.25dB$
- **Distortion, HD2:  $-50dBc$  at 5MHz**
- **Integrated CW Switch Matrix:**
  - Easy Current Summing
- **Serial Control Interface**
- **Small Package: QFN-64, 9×9mm**

### APPLICATIONS

- **Medical Imaging, Ultrasound Systems**
  - Portable Systems
  - Low- and Mid-Range Systems

### DESCRIPTION

The VCA8500 is an 8-channel variable gain amplifier consisting of a low-noise pre-amplifier (LNP) and a variable-gain amplifier (VGA). This combination, along with the device features, makes it ideal for a variety of ultrasound systems.

The LNP gain is fixed at 20dB, and has excellent noise and signal handling characteristics. The gain of the voltage-controlled attenuator can vary over a 46dB range with a 0V to 1.2V control voltage common to all channels of the VCA8500.

The post-gain amplifier (PGA) can be programmed for four gain settings: 20dB, 25dB, 27dB, or 30dB gain. As a means to improve system overload recovery time, the VCA8500 provides an internal clamping function. The PGA settings as well the clamp levels are controlled through the serial interface.

The VCA8500 is built on TI's BiCOM process and is available in a small QFN-64 PowerPAD™ package.

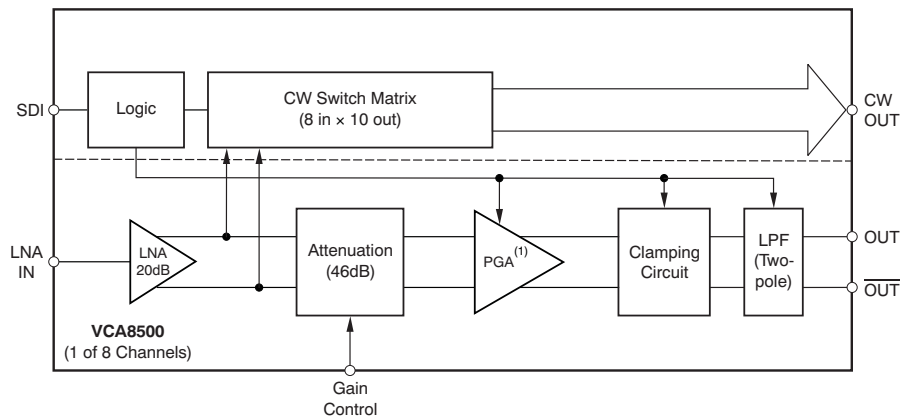

NOTE (1): 20dB, 25dB, 27dB, or 30dB gain setting.



Please be aware that an important notice concerning availability, standard warranty, and use in critical applications of Texas Instruments semiconductor products and disclaimers thereto appears at the end of this data sheet.

PowerPAD is a trademark of Texas Instruments.  
Infineon is a registered trademark of Infineon Technologies.  
SPI is a trademark of Motorola.  
All other trademarks are the property of their respective owners.



This integrated circuit can be damaged by ESD. Texas Instruments recommends that all integrated circuits be handled with appropriate precautions. Failure to observe proper handling and installation procedures can cause damage.

ESD damage can range from subtle performance degradation to complete device failure. Precision integrated circuits may be more susceptible to damage because very small parametric changes could cause the device not to meet its published specifications.

### PACKAGE/ORDERING INFORMATION<sup>(1)</sup>

PRODUCT	PACKAGE-LEAD	PACKAGE DESIGNATOR	SPECIFIED TEMPERATURE RANGE	PACKAGE MARKING	ORDERING NUMBER	TRANSPORT MEDIA, QUANTITY	ECO STATUS <sup>(2)</sup>
VCA8500	QFN-64	RGC	–40°C to +85°C	VCA8500	VCA8500IRGCT	Tape and Reel, 250	Pb-Free, Green
					VCA8500IRGCR	Tape and Reel, 2000	

- (1) For the most current package and ordering information, see the Package Option Addendum at the end of this document, or see the TI web site at [www.ti.com](http://www.ti.com).
- (2) **Eco-Status information:** Additional details including specific material content can be accessed at [www.ti.com/leadfree](http://www.ti.com/leadfree)  
**GREEN:** Ti defines Green to mean Lead (Pb)-Free and in addition, uses less package materials that do not contain halogens, including bromine (Br), or antimony (Sb) above 0.1% of total product weight.  
**N/A:** Not yet available Lead (Pb)-Free; for estimated conversion dates, go to [www.ti.com/leadfree](http://www.ti.com/leadfree).  
**Pb-FREE:** Ti defines Lead (Pb)-Free to mean RoHS compatible, including a lead concentration that does not exceed 0.1% of total product weight, and, if designed to be soldered, suitable for use in specified lead-free soldering processes.

### NOTE

These packages conform to Lead-Free and Green Manufacturing Specifications.



### ABSOLUTE MAXIMUM RATINGS<sup>(1)(2)</sup>

Over operating free-air temperature range, unless otherwise noted.

PARAMETER		VCA8500	UNIT
Supply voltage range, AVDD1		–0.3 to +3.9	V
Supply voltage range, AVDD2		–0.3 to +6	V
Supply voltage range, DVDD		–0.3 to +3.9	V
Voltage at analog inputs		–0.3 to (AVDD1 +0.3)	V
Voltage at digital inputs		–0.3 to (DVDD to +0.3)	V
Soldering temperature (lead, 5s) <sup>(3)</sup>		+260	°C
Maximum junction temperature (T <sub>J</sub> ), any condition <sup>(2)</sup>		+150	°C
Maximum junction temperature (T <sub>J</sub> ), continuous operation, long-term reliability <sup>(2)</sup>		+125	°C
Storage temperature range, T <sub>stg</sub>		–55 to +150	°C
Operating temperature range, T <sub>A</sub>		–40 to +85	°C
ESD rating	Human body model (HBM)	2000	V
	Charged device model (CDM)	1000	V
	Machine model (MM)	200	V

- (1) Stresses beyond those listed under absolute maximum ratings may cause permanent damage to the device. These are stress ratings only, and functional operation of the device at these or any other conditions beyond those indicated under recommended operating conditions is not implied. Exposure to absolute-maximum-rated conditions for extended periods may affect device reliability.
- (2) All voltage values are with respect to the ground terminal, which is the exposed thermal pad of the package.
- (3) Both the part being reworked and the board must be baked out before rework to reduce the risk of delamination. Refer to [Application Note SLUA271](#) (available for download at [www.ti.com](http://www.ti.com)) for recommended rework techniques.

## ELECTRICAL CHARACTERISTICS

All specifications at  $T_A = +25^\circ\text{C}$ ,  $AV_{DD2} = 5.0\text{V}$ ,  $AV_{DD1} = DV_{DD} = 3.3\text{V}$ ; single-ended, ac-coupled ( $1\mu\text{F}$ ) input configuration to the preamp (LNA),  $f_{IN} = 5\text{MHz}$ ,  $V_{CNTL} = 1.0\text{V}$ ,  $PG = 30\text{dB}$ , clamp disabled ( $CL = 1$ ),  $LPF = 15\text{MHz}$ , and  $R_{LOAD} = 1\text{k}\Omega$  on each output to ground, unless otherwise noted.

PARAMETER	TEST CONDITIONS	VCA8500			UNIT	TEST LEVEL <sup>(1)</sup>
		MIN	TYP	MAX		
<b>PREAMPLIFIER (LNA)</b>						
LNA gain	Single-ended input to differential output		20		dB	C
Input voltage	Linear operation ( $\text{THD} \leq -40\text{dBc}$ )		250		$\text{mV}_{PP}$	C
Input voltage noise	At $f = 2\text{MHz}$		0.70		$\text{nV}/\sqrt{\text{Hz}}$	B
Input current noise	At $f = 2\text{MHz}$		3.0		$\text{pA}/\sqrt{\text{Hz}}$	B
Input bias voltage ( $V_{BL}$ )	Internally generated		+2.4		V	B
Bandwidth	Small-signal, $-3\text{dB}$		55		MHz	C
Input resistance <sup>(2)</sup>	At $f = 4\text{MHz}$		8		$\text{k}\Omega$	C
Input capacitance <sup>(2)</sup>	Including internal ESD and clamping diodes		30		pF	C
<b>TGC SIGNAL PATH (LNA, VCA, PGA)</b>						
Input voltage noise	PGA = 30dB, $R_S = 0\Omega$ , $f = 2\text{MHz}$		0.81		$\text{nV}/\sqrt{\text{Hz}}$	B
	PGA = 20dB, $R_S = 0\Omega$ , $f = 2\text{MHz}$		0.95		$\text{nV}/\sqrt{\text{Hz}}$	B
Noise figure	$R_S = 200\Omega$ , $f = 1\text{MHz}$ to $10\text{MHz}$		1.1		dB	C
Group delay variation	1MHz to 10MHz		$\pm 3$		ns	B
Overload recovery time	To within 1% of $2V_{PP}$ output ( $V_{CNTL} = 0.54\text{V}$ ), PGA = 20dB		80		ns	B
Output voltage ( $V_{OUT}$ )	Differential, non-clipped		2		$V_{PP}$	B
Output common-mode voltage ( $V_{CM}$ )			+1.65		V	B
Output impedance	DC to 10MHz, single-ended, either output		1		$\Omega$	C
Output current	$R_L = 5\Omega$ into $V_{CM}$		$\pm 20$		mA	B
Second-harmonic distortion	$f_{IN} = 5\text{MHz}$ , PGA = 20dB, $V_{OUT} = 1V_{PP}$	-50	-60		dBc	A
	$f_{IN} = 5\text{MHz}$ , PGA = 30dB, $V_{OUT} = 2V_{PP}$	-42	-55		dBc	A
Third-harmonic distortion	$f_{IN} = 5\text{MHz}$ , PGA = 20dB, $V_{OUT} = 1V_{PP}$	-48	-68		dBc	A
	$f_{IN} = 5\text{MHz}$ , PGA = 30dB, $V_{OUT} = 2V_{PP}$	-40	-50		dBc	A
Two-tone intermodulation	$f_1 = 4.99\text{MHz}$ , $f_2 = 5.01\text{MHz}$ , $V_{CNTL} = 1\text{V}$ ; $V_{OUT} = 1V_{PP}$		-52		dBc	B
Crosstalk, channel-to-channel	Worst case; PGA = 20dB, $V_{CNTL} = 0.6\text{V}$ , $V_{OUT} = 1V_{PP}$		-67		dBc	B
	PGA = 30dB, $V_{OUT} = 1V_{PP}$		-66		dBc	B
<b>FILTER</b>						
Low-pass filter (second-order)	$-3\text{dB}$ point		10, 15		MHz	B
Tolerance			$\pm 15$		%	B
High-pass filter (first-order, due to internal ac coupling)	$-3\text{dB}$ point, $V_{CNTL} = 1.2\text{V}$		150		kHz	C

(1) Test levels: **(A)** 100% tested at  $+25^\circ\text{C}$ . Over temperature limits set by characterization and simulation. **(B)** Limits set by characterization and simulation, not production tested. **(C)** Typical value only for information.

(2) See Figure 29 of the Typical Characteristics.

## ELECTRICAL CHARACTERISTICS (continued)

All specifications at  $T_A = +25^\circ\text{C}$ ,  $AVDD2 = 5.0\text{V}$ ,  $AVDD1 = DVDD = 3.3\text{V}$ ; single-ended, ac-coupled ( $1\mu\text{F}$ ) input configuration to the preamp (LNA),  $f_{IN} = 5\text{MHz}$ ,  $V_{CNTL} = 1.0\text{V}$ ,  $PG = 30\text{dB}$ , clamp disabled ( $CL = 1$ ),  $LPF = 15\text{MHz}$ , and  $R_{LOAD} = 1\text{k}\Omega$  on each output to ground, unless otherwise noted.

PARAMETER	TEST CONDITIONS	VCA8500			UNIT	TEST LEVEL <sup>(1)</sup>
		MIN	TYP	MAX		
<b>ACCURACY</b>						
Gain (PGA)	Selectable through SPI™		20, 25, 27, 30		dB	A
Total gain, maximum	LNA + PGA gain, $V_{CNTL} = 1.2\text{V}$	48	49.5	51	dB	A
Gain range	$V_{CNTL} = 0\text{V}$ to $1.2\text{V}$		46		dB	A
Gain range	$V_{CNTL} = 0.1\text{V}$ to $1.0\text{V}$		40		dB	A
Gain slope	$V_{CNTL} = 0.1\text{V}$ to $1.0\text{V}$		44.4		dB/V	A
Gain error, absolute	$0\text{V} < V_{CNTL} < 0.1\text{V}$		$\pm 0.5$		dB	A
	$0.1\text{V} < V_{CNTL} < 1.0\text{V}$	-1.5	$\pm 0.5$	+1.5	dB	A
	$1.0\text{V} < V_{CNTL} < 1.2\text{V}$		$\pm 0.5$		dB	A
Gain matching	Channel-to-channel		$\pm 0.25$	$\pm 0.5$	dB	A
Output offset voltage	Differential	-25	$\pm 1$	+25	mV	A
	Single-ended <sup>(3)</sup>	-50	$\pm 25$	+50	mV	A
Clamp level ( $V_{OUT}$ )	$CL = 0$		1.7		$V_{PP}$	A
	$CL = 1$ (clamp disabled)		2.8		$V_{PP}$	B
<b>GAIN CONTROL INTERFACE</b>						
Input voltage range ( $V_{CNTL}$ )	Gain range = 46dB		0 to 1.2		V	A
Input resistance			25		k $\Omega$	C
Response time	$V_{CNTL} = 0\text{V}$ to $1.2\text{V}$ step; to 90% signal level, $V_{OUT} = 1V_{PP}$		0.5		$\mu\text{s}$	B
Gain control bandwidth			1.5		MHz	C
<b>CW SIGNAL PATH</b>						
Output transconductance ( $V/I$ )	At $V_{IN} = 100\text{mV}_{PP}$	14	16.4	18	$\text{mA/V}$	A
	At $V_{IN} = 200\text{mV}_{PP}$		14.5		$\text{mA/V}$	B
Dynamic CW output current, max			2.9		$\text{mA}_{PP}$	B
Static CW output current (sink)			0.9		mA	B
Output common-mode voltage ( $V_{CM0}$ )	Supplied externally		+2.5		V	B
Output compliance range	Symmetric around $V_{CM0}$		$\pm 0.5$		V	B
Output capacitance			10		pF	C
Output impedance			50		k $\Omega$	C
Input voltage noise, CW mode	At $f = 2\text{MHz}$		1.15		$\text{nV}/\sqrt{\text{Hz}}$	B
Signal-dependent noise (RTO)	At 2kHz offset from 2MHz CW carrier		+2		dB	B
	At 2kHz offset from 5MHz CW carrier		+2		dB	B
Output noise correlation factor	Summing of eight channels (all modes) [compared to ideal 0dB]		0.6		dB	B

(3) Deviation from ideal common-mode voltage ( $V_{CM} = 1.65\text{V}$ ).

## ELECTRICAL CHARACTERISTICS (continued)

All specifications at  $T_A = +25^\circ\text{C}$ ,  $AVDD2 = 5.0\text{V}$ ,  $AVDD1 = DVDD = 3.3\text{V}$ ; single-ended, ac-coupled ( $1\mu\text{F}$ ) input configuration to the preamp (LNA),  $f_{IN} = 5\text{MHz}$ ,  $V_{CNTL} = 1.0\text{V}$ ,  $PG = 30\text{dB}$ , clamp disabled ( $CL = 1$ ),  $LPF = 15\text{MHz}$ , and  $R_{LOAD} = 1\text{k}\Omega$  on each output to ground, unless otherwise noted.

PARAMETER	TEST CONDITIONS	VCA8500			UNIT	TEST LEVEL <sup>(1)</sup>
		MIN	TYP	MAX		
<b>DIGITAL INPUTS (SDI)</b>	(PD, DIN, DOUT, CLK, RST)					
$V_{IH}$ , high-level input voltage		2.0		$V_D$	V	B
$V_{IL}$ , low-level input voltage		0		0.8	V	B
Input current			$\pm 10$		$\mu\text{A}$	A
Clock frequency ( $f_{CLK}$ )		10k		20M	Hz	B
Input resistance			1		$\text{M}\Omega$	C
Input capacitance			5		pF	C
<b>POWER SUPPLY</b>						
<b>Supply Voltages</b>						
AVDD1, DVDD	Operating	3.15	3.3	3.6	V	B
AVDD2	Operating	4.75	5	5.25	V	B
<b>Supply Currents<sup>(4)</sup></b>						
IAVDD1	TGC mode ( $D5 = 1$ )		145	156	mA	A
	CW mode ( $D5 = 0$ )		78	84	mA	A
IDVDD	TGC, CW mode		1.5	3	mA	A
IAVDD2	TGC mode		8	10	mA	A
	CW mode		54	59	mA	A
Power dissipation, total	All channels, TGC mode, no signal		522	570	mW	A
	All channels, CW mode, no signal		533	575	mW	A
<b>POWER-DOWN MODES</b>						
<b>Standby Mode</b>	PD (pin 49) = high					
IAVDD1			18		mA	A
IDVDD			1.5		mA	A
IAVDD2			8		mA	A
Power dissipation			104	130	mW	A
Power-down response time			0.2		$\mu\text{s}$	C
Power-up response time <sup>(5)</sup>	PD to valid output (90% level)		50		$\mu\text{s}$	C
<b>Shut-Down Mode</b>	D2 (PWR) = high					
IAVDD1			1.5		mA	A
IDVDD			1.5		mA	A
IAVDD2			2		mA	A
Power dissipation			19	35	mW	A
<b>THERMAL CHARACTERISTICS</b>						
Temperature range	Ambient, operating	-40		+85	$^\circ\text{C}$	
Thermal resistance, $\theta_{JA}$	Soldered pad; four-layer PCB with thermal vias		22.5		$^\circ\text{C}/\text{W}$	
Thermal resistance, $\theta_{JC}$			17.0		$^\circ\text{C}/\text{W}$	

(4) Clamp enabled ( $D4 = 0$ ).

(5) See [Figure 59](#) of the Typical Characteristics.

DEVICE INFORMATION

RGC PACKAGE  
QFN-64  
(TOP VIEW)

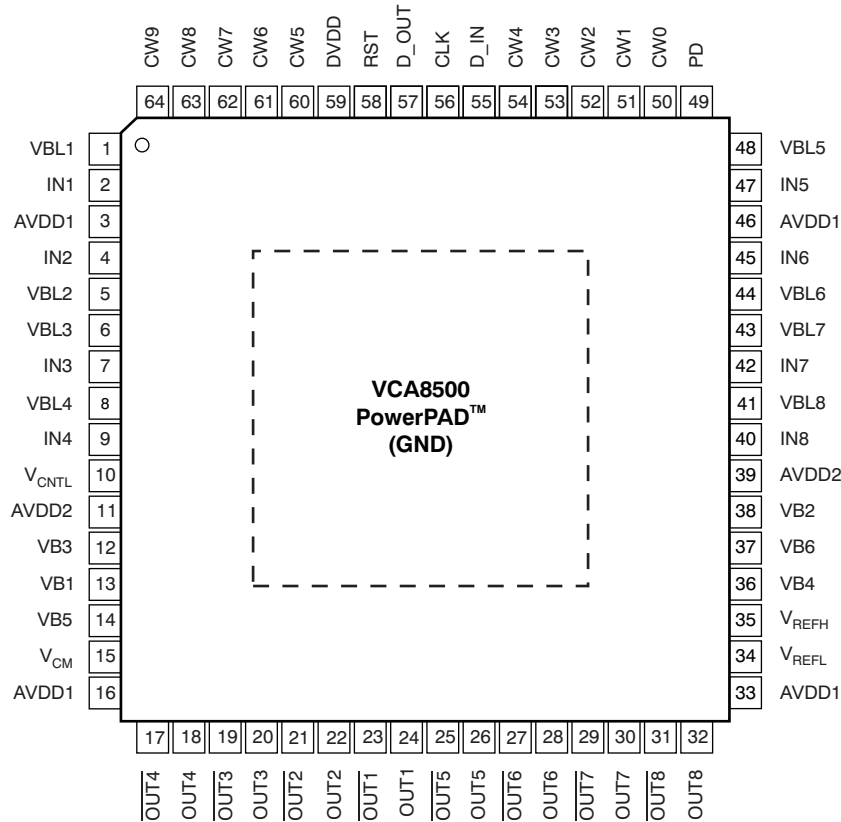

Table 1. TERMINAL FUNCTIONS

TERMINAL		I/O	DESCRIPTION
PIN NO.	NAME		
1	VBL1		LNA bias voltage (+2.4V); bypass with 0.1µF capacitor (min)
2	IN1	I	LNA input channel 1
3	AVDD1		+3.3V analog supply
4	IN2	I	LNA input channel 2
5	VBL2		LNA bias voltage (+2.4V); bypass with 0.1µF capacitor (min)
6	VBL3		LNA bias voltage (+2.4V); bypass with 0.1µF capacitor (min)
7	IN3	I	LNA input channel 3
8	VBL4		LNA bias voltage (+2.4V); bypass with 0.1µF capacitor (min)
9	IN4		LNA input channel 4
10	V <sub>CNTL</sub>	I	Attenuator control voltage input (all channels)
11	AVDD2		+5V analog supply (VCA, CW)
12	VB3		Internal bias voltage (+4.2V); bypass with 0.1µF capacitor (min)
13	VB1		Internal bias voltage (+2.4V); bypass with 2.2µF capacitor (1.0µF min)
14	VB5		Internal bias voltage (+2.4V); bypass with 0.1µF capacitor (min)
15	V <sub>CM</sub>		Internal common-mode voltage (+1.65V); bypass with 0.1µF capacitor (min)
16	AVDD1		+3.3V analog supply
17	OUT4	O	PGA output channel 4 (inverted)
18	OUT4	O	PGA output channel 4

**Table 1. TERMINAL FUNCTIONS (continued)**

TERMINAL		I/O	DESCRIPTION
PIN NO.	NAME		
19	$\overline{\text{OUT3}}$	O	PGA output channel 3 (inverted)
20	OUT3	O	PGA output channel 3
21	$\overline{\text{OUT2}}$	O	PGA output channel 2 (inverted)
22	OUT2	O	PGA output channel 2
23	$\overline{\text{OUT1}}$	O	PGA output channel 1 (inverted)
24	OUT1	O	PGA output channel 1
25	$\overline{\text{OUT5}}$	O	PGA output channel 5 (inverted)
26	OUT5	O	PGA output channel 5
27	$\overline{\text{OUT6}}$	O	PGA output channel 6 (inverted)
28	OUT6	O	PGA output channel 6
29	$\overline{\text{OUT7}}$	O	PGA output channel 7 (inverted)
30	OUT7	O	PGA output channel 7
31	$\overline{\text{OUT8}}$	O	PGA output channel 8 (inverted)
32	OUT8	O	PGA output channel 8
33	AVDD1		+3.3V analog supply
34	V <sub>REFL</sub>		Clamp reference level low, 2.0V; bypass with 0.1 $\mu$ F capacitor (min)
35	V <sub>REFH</sub>		Clamp reference level high, 2.7V; bypass with 0.1 $\mu$ F capacitor (min)
36	VB4		Internal bias voltage (+2.4V); bypass with 0.1 $\mu$ F capacitor (min)
37	VB6		Internal bias voltage (+2.9V); bypass with 0.1 $\mu$ F capacitor (min)
38	VB2		Internal bias voltage (+2.7V); bypass with 0.1 $\mu$ F capacitor (min)
39	AVDD2		+5V analog supply (VCA, CW)
40	IN8	I	LNA input channel 8
41	VBL8		LNA bias voltage (+2.4V); bypass with 0.1 $\mu$ F capacitor (min)
42	IN7	I	LNA input channel 7
43	VBL7		LNA bias voltage (+2.4V); bypass with 0.1 $\mu$ F capacitor (min)
44	VBL6	I	LNA bias voltage (+2.4V); bypass with 0.1 $\mu$ F capacitor (min)
45	IN6		LNA input channel 6
46	AVDD1		+3.3V analog supply
47	IN5	I	LNA input channel 5
48	VBL5		LNA bias voltage (+2.4V); bypass with 0.1 $\mu$ F capacitor (min)
49	PD	I	Power-down pin for standby mode; 0 = normal operation, 1 = power down
50	CW0	O	CW channel 0 current output
51	CW1	O	CW channel 1 current output
52	CW2	O	CW channel 2 current output
53	CW3	O	CW channel 3 current output
54	CW4	O	CW channel 4 current output
55	D_IN	I	Serial data input
56	CLK	I	Clock input for serial interface
57	D_OUT	O	Serial data output
58	RST	I	Reset input; rising edge resets register to default values.
59	DVDD		+3.3V digital supply; connect to a low-noise analog supply plane (AVDD1)
60	CW5		CW channel 5 current output
61	CW6		CW channel 6 current output
62	CW7		CW channel 7 current output
63	CW8		CW channel 8 current output
64	CW9		CW channel 9 current output
—	GND		PowerPAD must be connected to the analog ground of the printed circuit board; use this ground for bypass capacitor return ground.

**FUNCTIONAL BLOCK DIAGRAM**

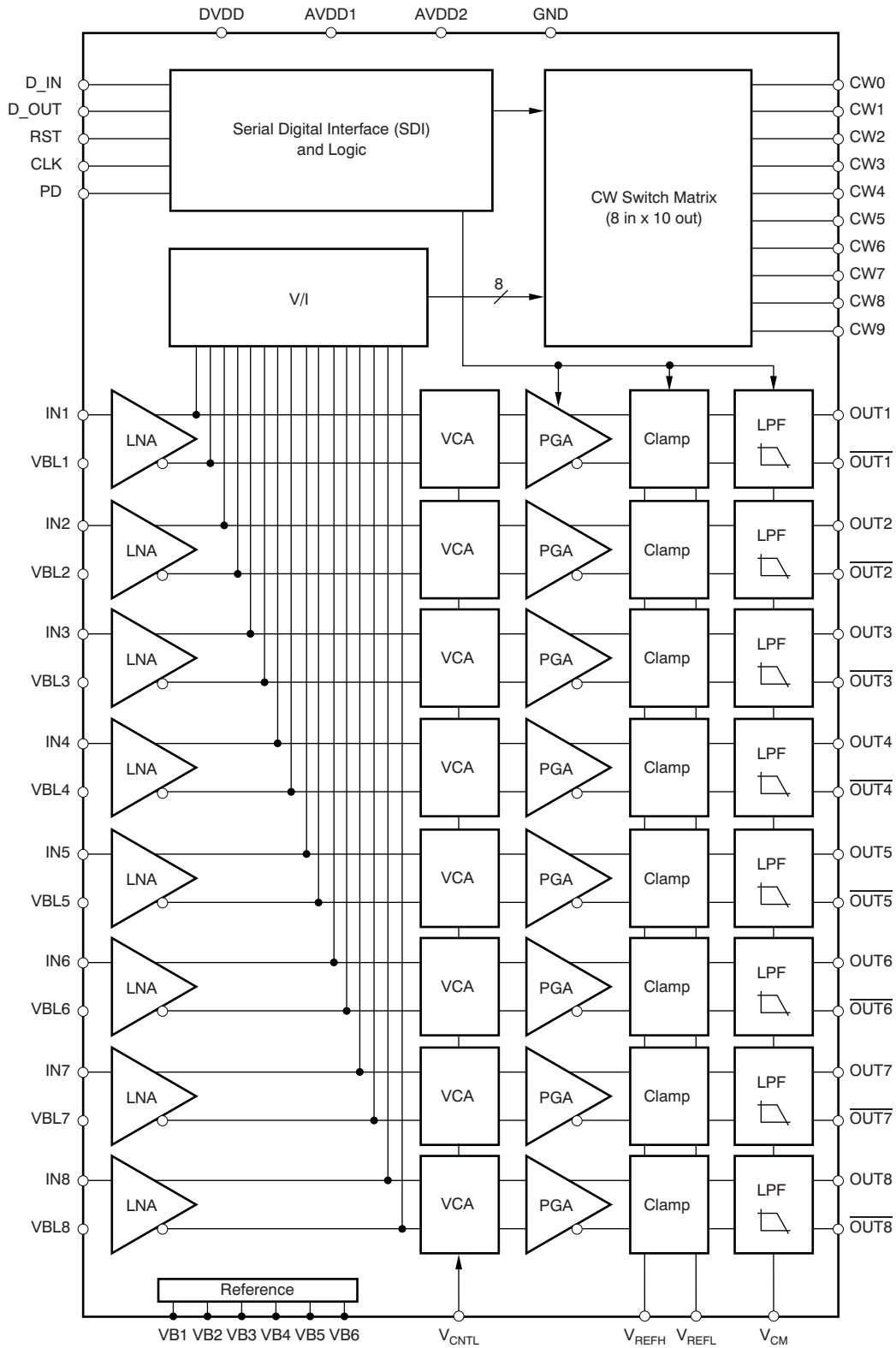



## INPUT REGISTER BIT MAPS

### Register Map

BYTE #1	BYTE #2		BYTE #3		BYTE #4		BYTE #5	
D0:D7	D8:D11	D12:D15	D16:D19	D20:D23	D24:D27	D28:D31	D32:D35	D36:D39
Control	CH1	CH2	CH3	CH4	CH5	CH6	CH7	CH8

**Table 2. Default Register Configuration**

D7	D6	D5	D4	D3	D2	D1	D0
0	0	1	0	0	0	1	1

**Table 3. Byte 1—Control Byte Register Map**

BIT #	NAME	DESCRIPTION
D0 (LSB)	1	Start bit; must be a '1' (high); 40-bit countdown starts with first falling clock edge.
D1	R $\overline{W}$	1 = Write, 0 = Read; read prevents latching of new data/bits. Control register remains latched with previously loaded data.
D2	PWR	1 = Power-down mode enabled (shutdown).
D3	BW	Low-pass filter bandwidth setting (see <a href="#">Table 8</a> )
D4	CL	Clamp level setting (see <a href="#">Table 8</a> )
D5	Mode	1 = TGC mode, 0 = CW doppler mode (TGC powered down)
D6	PG0	LSB of PGA gain control (see <a href="#">Table 9</a> )
D7 (MSB)	PG1	MSB of PGA gain control

**Table 4. Byte 2—First Data Byte**

BIT #	NAME	DESCRIPTION
D8 (LSB)	DB1:1	Channel 1, LSB of matrix control
D9	DB1:2	Channel 1, matrix control
D10	DB1:3	Channel 1, matrix control
D11	DB1:4	Channel 1, MSB of matrix control
D12	DB2:1	Channel 2, LSB of matrix control
D13	DB2:2	Channel 2, matrix control
D14	DB2:3	Channel 2, matrix control
D15 (MSB)	DB2:4	Channel 2; MSB of matrix control

**Table 5. Byte 3—Second Data Byte**

BIT #	NAME	DESCRIPTION
D16 (LSB)	DB3:1	Channel 3, LSB of matrix control
D17	DB3:2	Channel 3, matrix control
D18	DB3:3	Channel 3, matrix control
D19	DB3:4	Channel 3, MSB of matrix control
D20	DB4:1	Channel 4, LSB of matrix control
D21	DB4:2	Channel 4, matrix control
D22	DB4:3	Channel 4, matrix control
D23 (MSB)	DB4:4	Channel 4, MSB of matrix control

**Table 6. Byte 4—Third Data Byte**

BIT #	NAME	DESCRIPTION
D24 (LSB)	DB5:1	Channel 5, LSB of matrix control
D25	DB5:2	Channel 5, matrix control
D26	DB5:3	Channel 5, matrix control
D27	DB5:4	Channel 5, MSB of matrix control
D28	DB6:1	Channel 6; LSB of matrix control
D29	DB6:2	Channel 6, matrix control
D30	DB6:3	Channel 6, matrix control
D31 (MSB)	DB6:4	Channel 6, MSB of matrix control

**Table 7. Byte 5—Fourth Data Byte**

BIT #	NAME	DESCRIPTION
D32 (LSB)	DB7:1	Channel 7, LSB of matrix control
D33	DB7:2	Channel 7, matrix control
D34	DB7:3	Channel 7, matrix control
D35	DB7:4	Channel 7, MSB of matrix control
D36	DB8:1	Channel 8; LSB of matrix control
D37	DB8:2	Channel 8, matrix control
D38	DB8:3	Channel 8, matrix control
D39 (MSB)	DB8:4	Channel 8, MSB of matrix control

**Table 8. Clamp Level and LPF Bandwidth Setting**

NAME	SETTING	FUNCTION
BW	D3 = 0	Bandwidth set to 15MHz (default)
	D3 = 1	Bandwidth set to 10MHz
CL	D4 = 0	Clamps the output signal at 1.7V <sub>PP</sub> on each PGA output channel (default)
	D4 = 1	Clamp transparent (disabled)

**Table 9. PGA Gain Setting**

PG1	PG0	FUNCTION
0	0	Set PGA gain to 20dB (default)
0	1	Set PGA gain to 25dB
1	0	Set PGA gain to 27dB
1	1	Set PGA gain to 30dB

**Table 10. CW Switch Matrix Control for Each Channel**

DBn:4 (MSB)	DBn:3	DBn:2	DBn:1 (LSB)	LNA Input Channel Directed To:
0	0	0	0	Output CW0
0	0	0	1	Output CW1
0	0	1	0	Output CW2
0	0	1	1	Output CW3
0	1	0	0	Output CW4
0	1	0	1	Output CW5
0	1	1	0	Output CW6
0	1	1	1	Output CW7
1	0	0	0	Output CW8
1	0	0	1	Output CW9
1	0	1	0	Connected to AVDD2; channel disabled
1	0	1	1	Connected to AVDD2; channel disabled
1	1	0	0	Connected to AVDD2; channel disabled
1	1	0	1	Connected to AVDD2; channel disabled
1	1	1	0	Connected to AVDD2; channel disabled
1	1	1	1	Connected to AVDD2; channel disabled

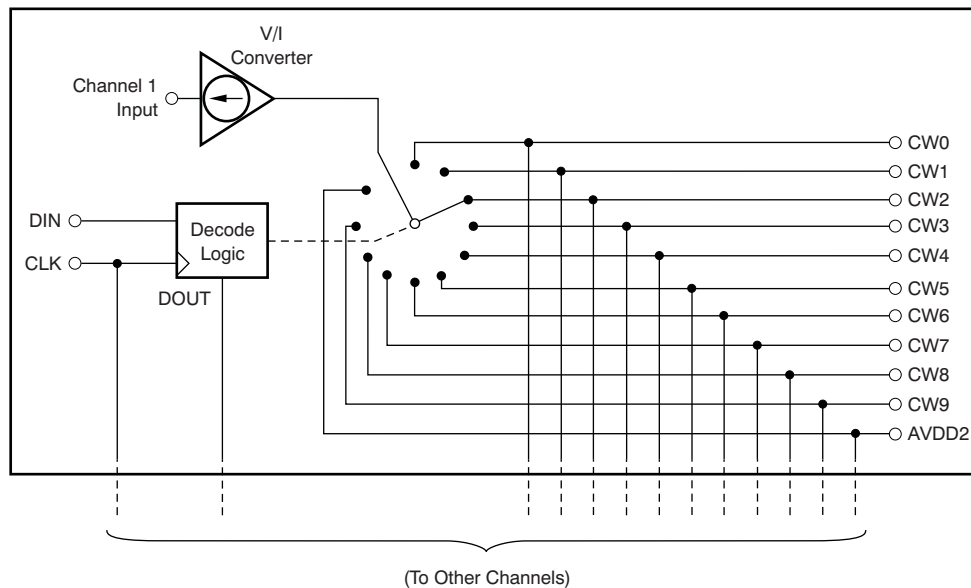
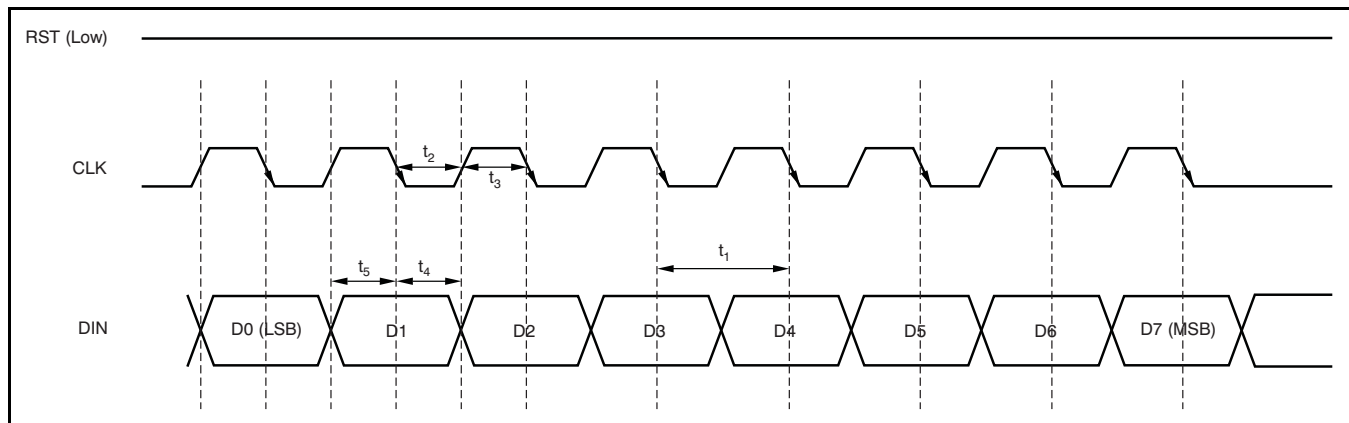

**Figure 1. Basic CW Cross-Point Switch Matrix Configuration**

## SERIAL DIGITAL INTERFACE (SDI)

- All writes and reads are five bytes at a time. Each byte consists of 8 bits, for a total instruction set of 40 bits.
- Data are latched on the falling edge of CLK.
- Separate write (DIN) and read data (DOUT) lines.
- Reads follow the same bitstream pattern seen in the write cycle.
- Reads extract data from the FIFO buffer, not the latched register.
- DOUT data are continuously available and do not need to be enabled with a read cycle. Selecting a read cycle in the control register only prevents latching of data. The control register remains latched.
- The Reset pin (RST) must be low in order to allow the register to update with new data. RST can be held low permanently. To initiate a reset cycle, pull the RST pin high for at least 100ns.

## TIMING INFORMATION



NOTE: This figure shows timing example for one data byte. A full register update cycle requires all five bytes (that is, 40 bits).

### SERIAL PORT TIMING TABLE

PARAMETER	DESCRIPTION	MIN	TYP	MAX	UNIT
$t_1$	Serial CLK period	100			ns
$t_2$	Serial CLK HIGH time	40			ns
$t_3$	Serial CLK LOW time	40			ns
$t_4$	Data hold time	5			ns
$t_5$	Data setup time	5			ns
RST	Reset pulse (L - H - L)	100			ns

**TYPICAL CHARACTERISTICS**

All specifications at  $T_A = +25^\circ\text{C}$ ,  $AV_{DD2} = 5.0\text{V}$ ,  $AV_{DD1} = DV_{DD} = 3.3\text{V}$ ; single-ended, ac-coupled ( $1\mu\text{F}$ ) input configuration to the preamp (LNA),  $f_{IN} = 5\text{MHz}$ ,  $V_{CNTRL} = 1.0\text{V}$ , clamp disabled ( $CL = 1$ ), LPF = 15MHz, and  $R_{LOAD} = 1\text{k}\Omega$  on each output to ground, unless otherwise noted.

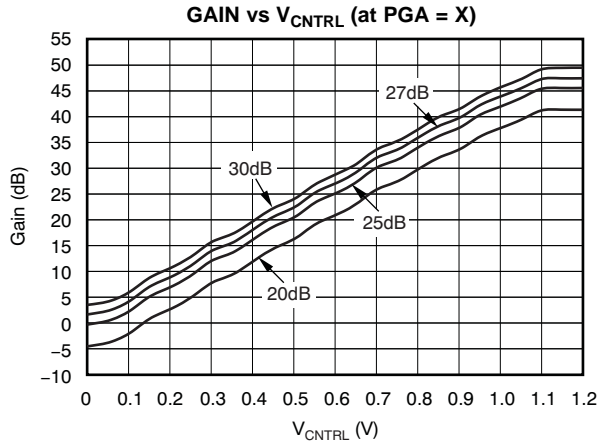

Figure 2.

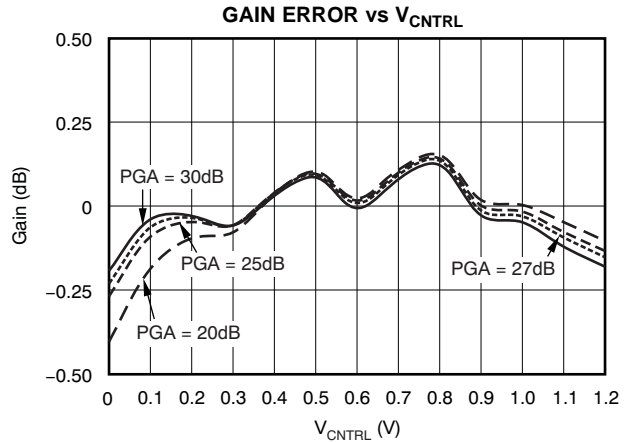

Figure 3.

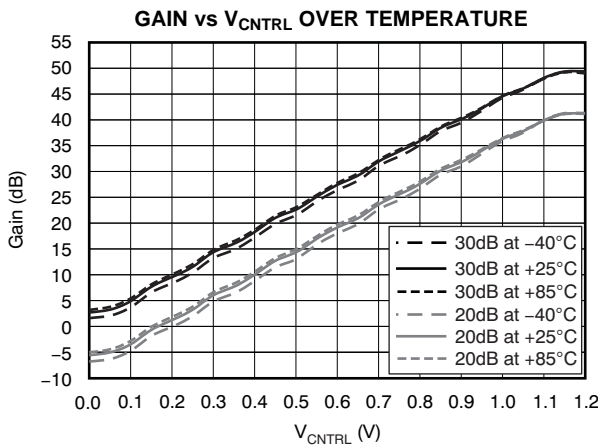

Figure 4.

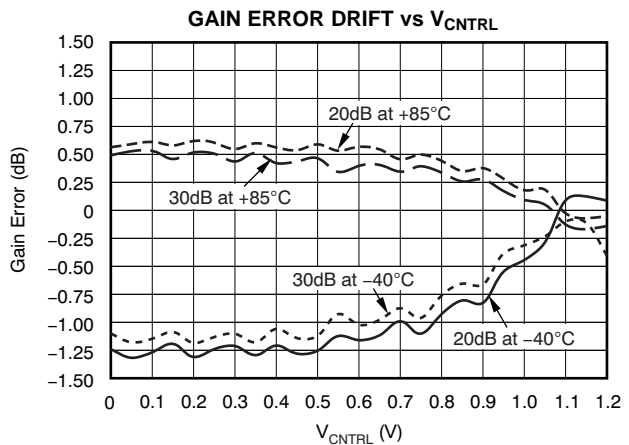

Figure 5.

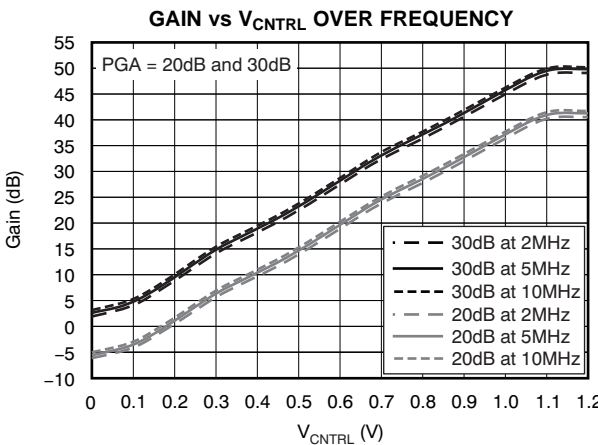

Figure 6.

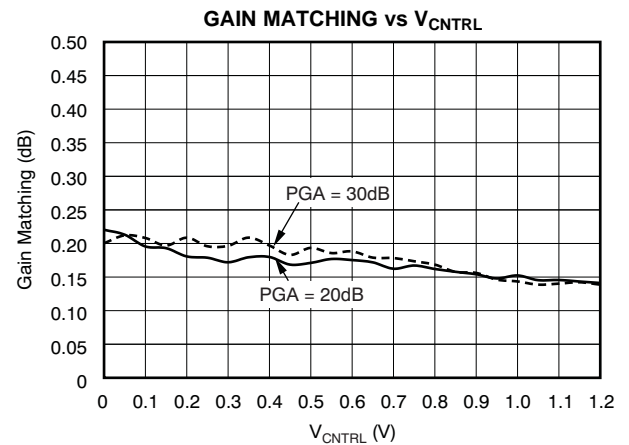
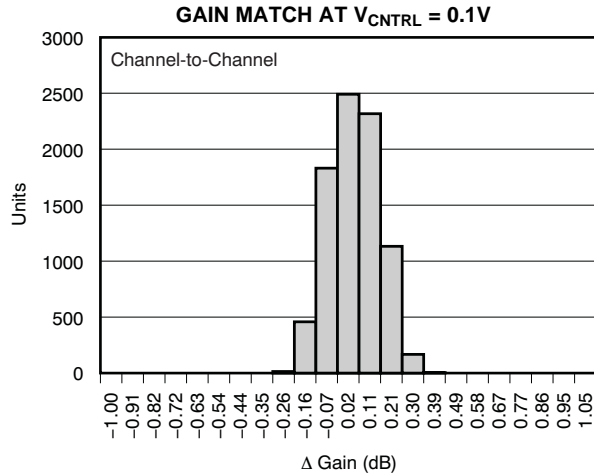

Figure 7.

**TYPICAL CHARACTERISTICS (continued)**

All specifications at  $T_A = +25^\circ\text{C}$ ,  $AVDD2 = 5.0\text{V}$ ,  $AVDD1 = DVDD = 3.3\text{V}$ ; single-ended, ac-coupled ( $1\mu\text{F}$ ) input configuration to the preamp (LNA),  $f_{IN} = 5\text{MHz}$ ,  $V_{CNTRL} = 1.0\text{V}$ , clamp disabled ( $CL = 1$ ),  $\text{LPF} = 15\text{MHz}$ , and  $R_{LOAD} = 1\text{k}\Omega$  on each output to ground, unless otherwise noted.



**Figure 8.**

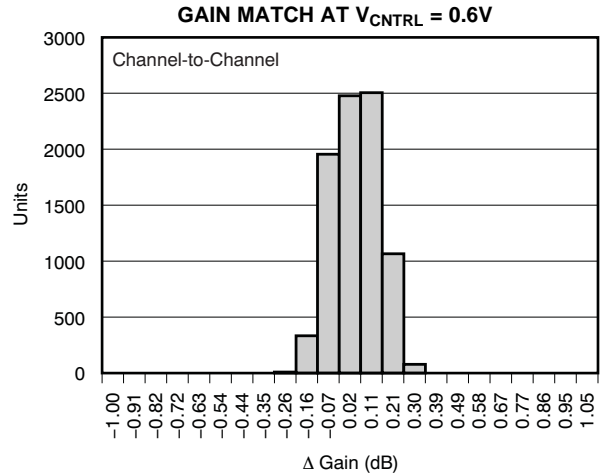

**Figure 9.**

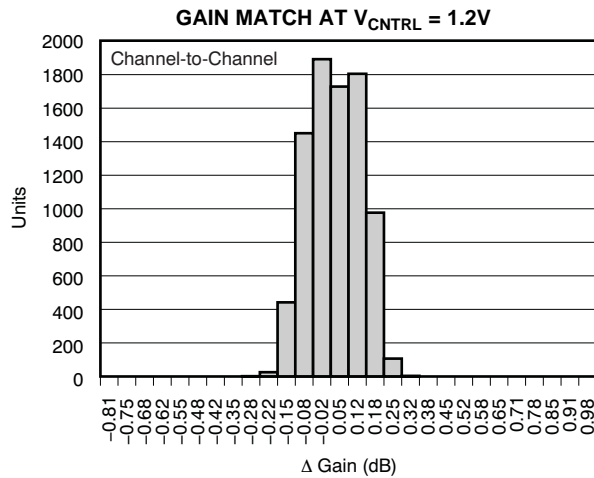

**Figure 10.**

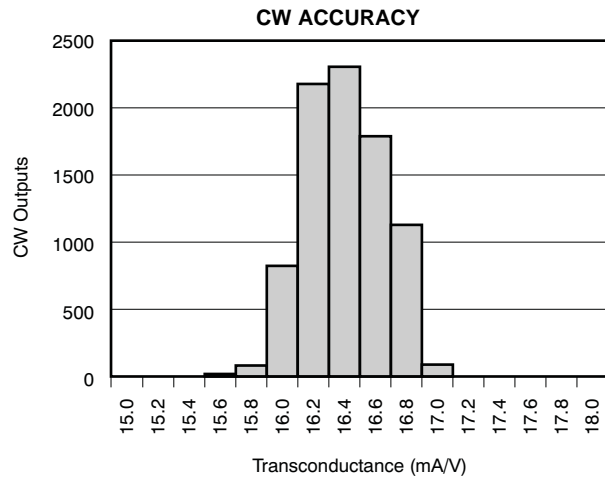

**Figure 11.**

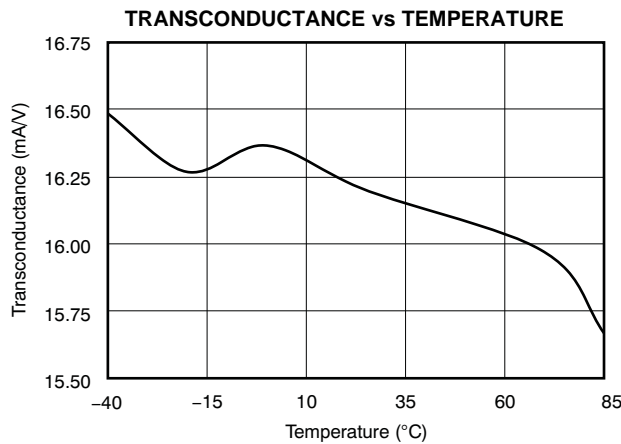

**Figure 12.**

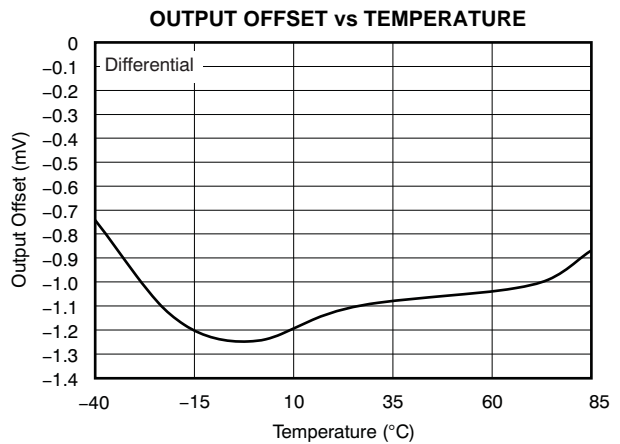

**Figure 13.**

**TYPICAL CHARACTERISTICS (continued)**

All specifications at  $T_A = +25^\circ\text{C}$ ,  $AVDD2 = 5.0\text{V}$ ,  $AVDD1 = DVDD = 3.3\text{V}$ ; single-ended, ac-coupled ( $1\mu\text{F}$ ) input configuration to the preamp (LNA),  $f_{IN} = 5\text{MHz}$ ,  $V_{CNTRL} = 1.0\text{V}$ , clamp disabled ( $CL = 1$ ),  $LPF = 15\text{MHz}$ , and  $R_{LOAD} = 1\text{k}\Omega$  on each output to ground, unless otherwise noted.

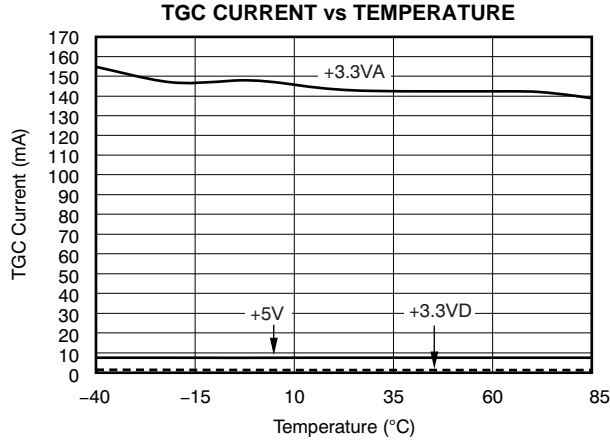

Figure 14.

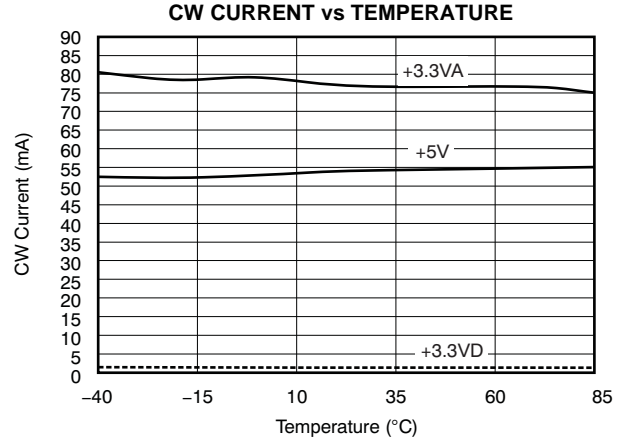

Figure 15.

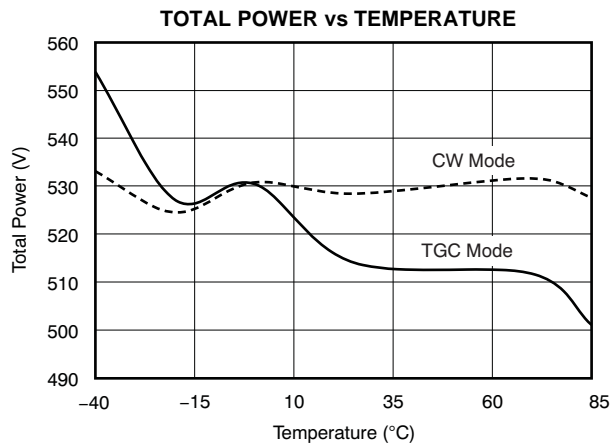

Figure 16.

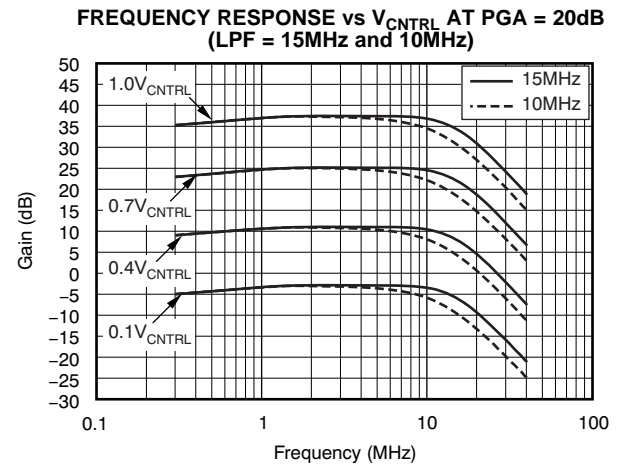

Figure 17.

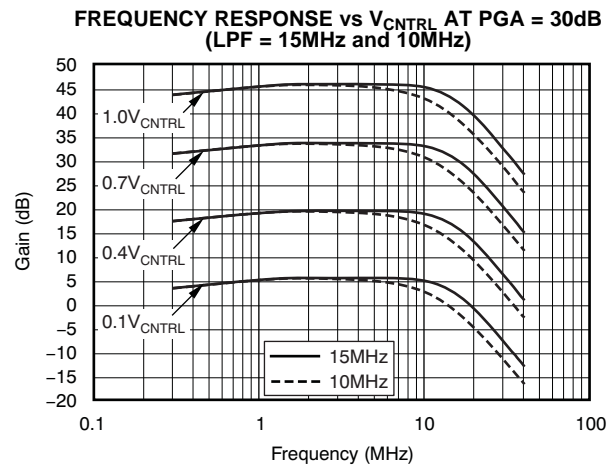

Figure 18.

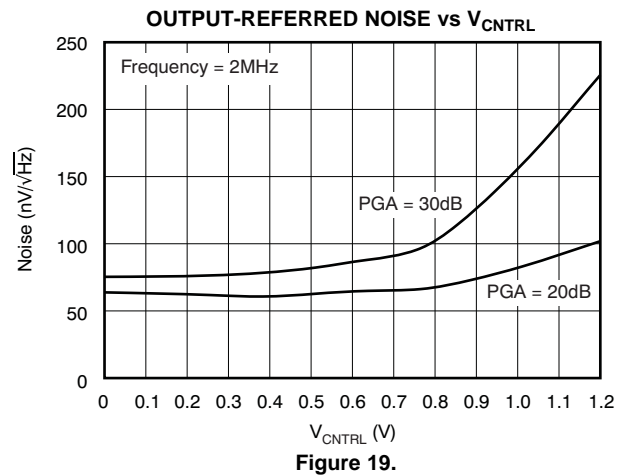

Figure 19.

**TYPICAL CHARACTERISTICS (continued)**

All specifications at  $T_A = +25^\circ\text{C}$ ,  $AVDD2 = 5.0\text{V}$ ,  $AVDD1 = DVDD = 3.3\text{V}$ ; single-ended, ac-coupled ( $1\mu\text{F}$ ) input configuration to the preamp (LNA),  $f_{IN} = 5\text{MHz}$ ,  $V_{CNTRL} = 1.0\text{V}$ , clamp disabled ( $CL = 1$ ),  $LPF = 15\text{MHz}$ , and  $R_{LOAD} = 1\text{k}\Omega$  on each output to ground, unless otherwise noted.

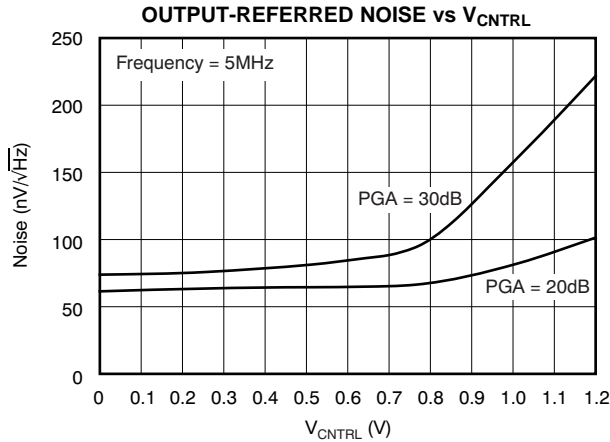

Figure 20.

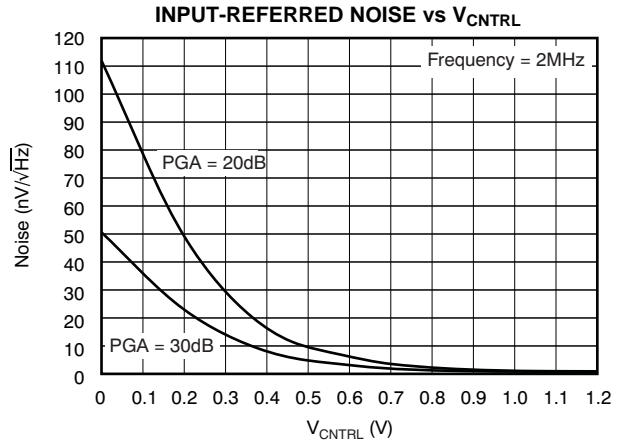

Figure 21.

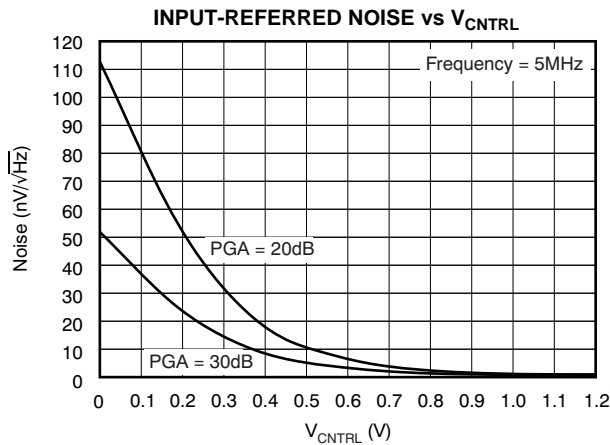

Figure 22.

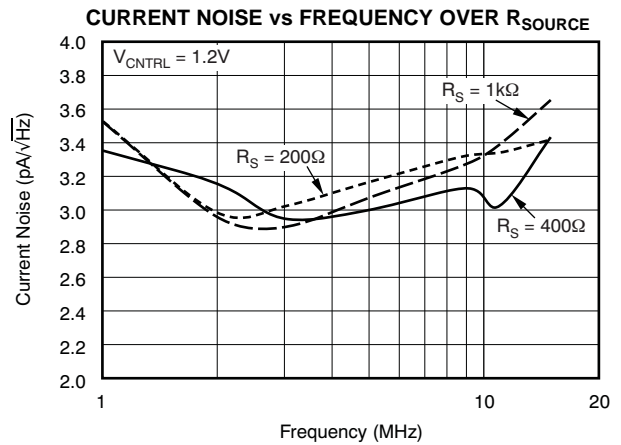

Figure 23.

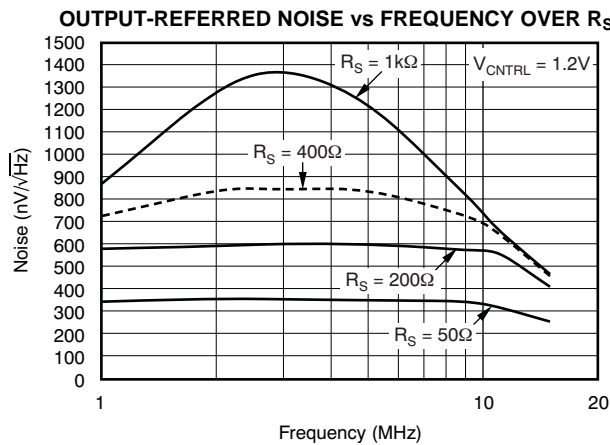

Figure 24.

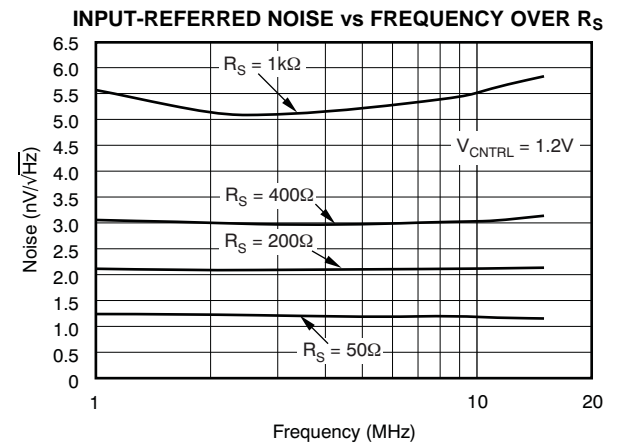

Figure 25.



**TYPICAL CHARACTERISTICS (continued)**

All specifications at  $T_A = +25^\circ\text{C}$ ,  $AVDD2 = 5.0\text{V}$ ,  $AVDD1 = DVDD = 3.3\text{V}$ ; single-ended, ac-coupled ( $1\mu\text{F}$ ) input configuration to the preamp (LNA),  $f_{IN} = 5\text{MHz}$ ,  $V_{CNTRL} = 1.0\text{V}$ , clamp disabled ( $CL = 1$ ),  $LPF = 15\text{MHz}$ , and  $R_{LOAD} = 1\text{k}\Omega$  on each output to ground, unless otherwise noted.

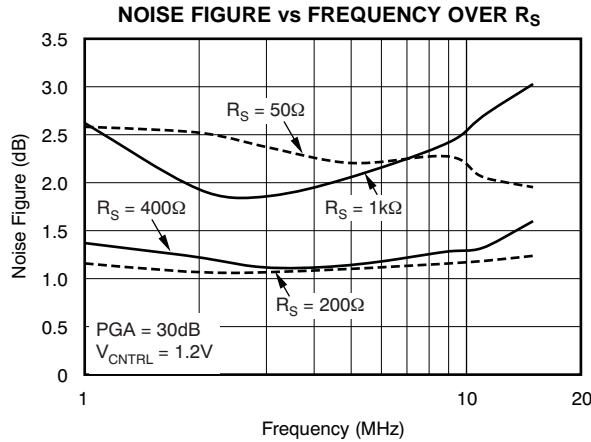

Figure 26.

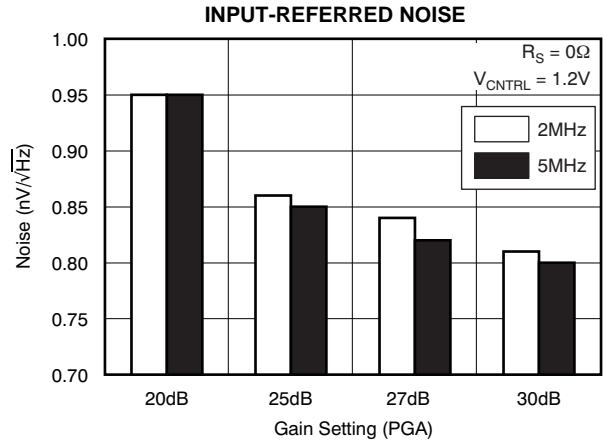

Figure 27.

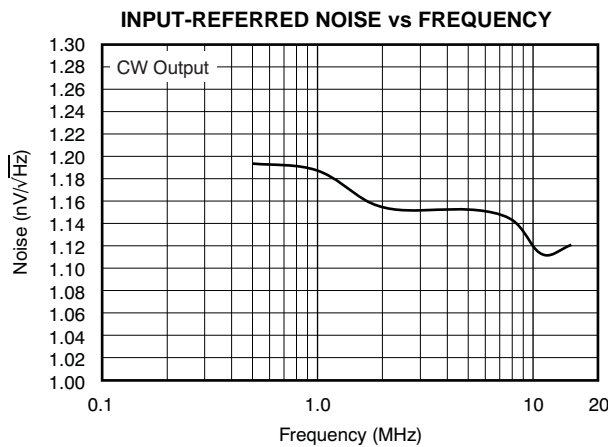

Figure 28.

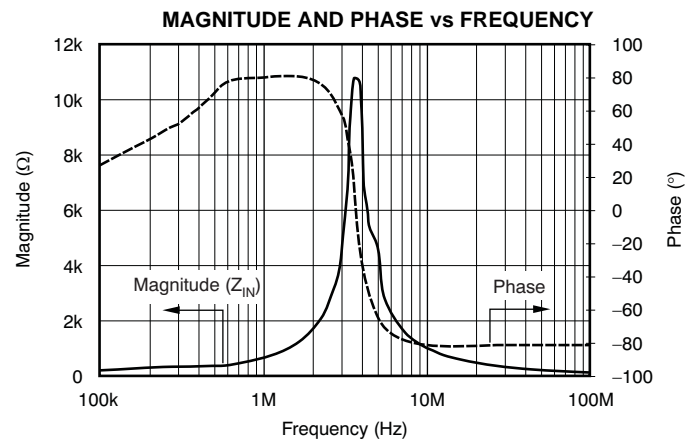

Figure 29.

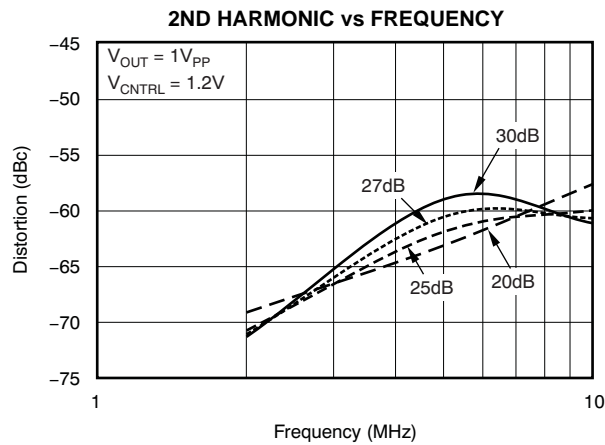

Figure 30.

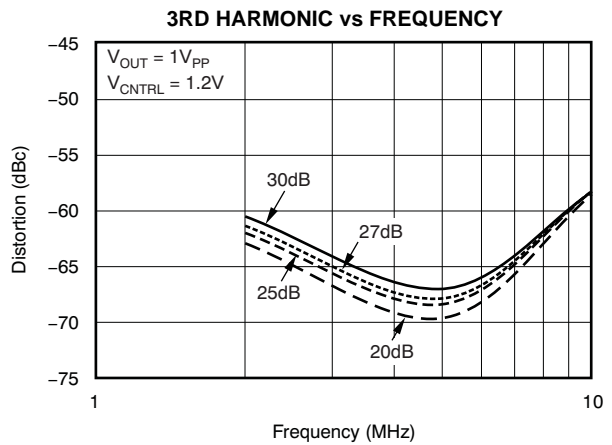

Figure 31.

**TYPICAL CHARACTERISTICS (continued)**

All specifications at  $T_A = +25^\circ\text{C}$ ,  $AVDD2 = 5.0\text{V}$ ,  $AVDD1 = DVDD = 3.3\text{V}$ ; single-ended, ac-coupled ( $1\mu\text{F}$ ) input configuration to the preamp (LNA),  $f_{IN} = 5\text{MHz}$ ,  $V_{CNTRL} = 1.0\text{V}$ , clamp disabled ( $CL = 1$ ), LPF =  $15\text{MHz}$ , and  $R_{LOAD} = 1\text{k}\Omega$  on each output to ground, unless otherwise noted.

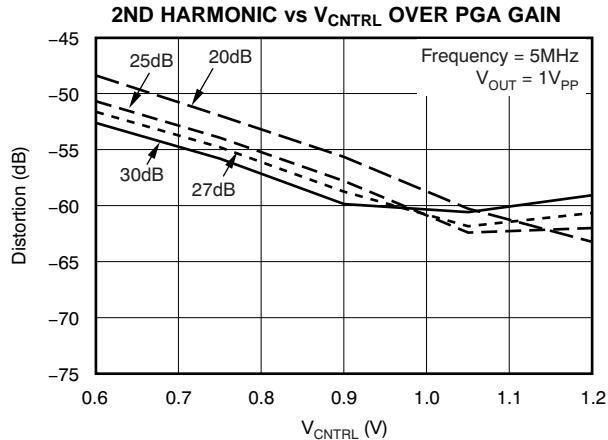

Figure 32.

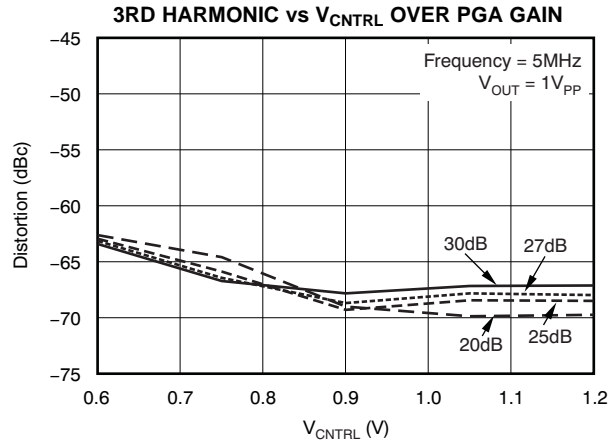

Figure 33.

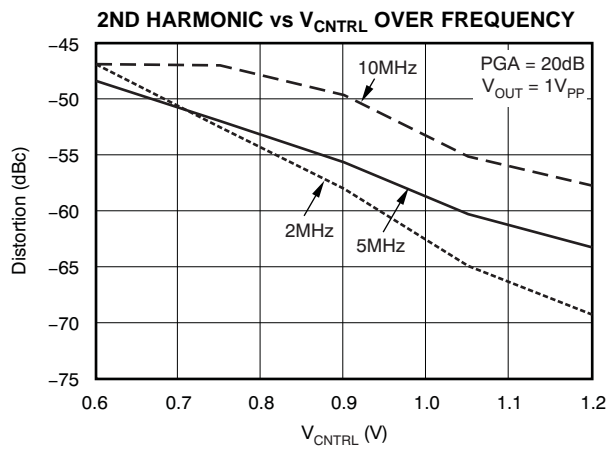

Figure 34.

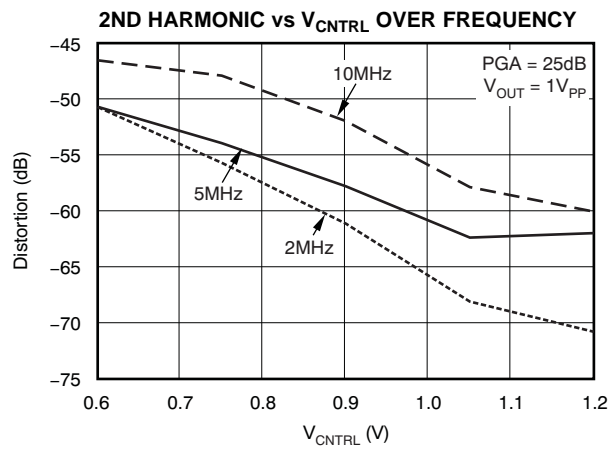

Figure 35.

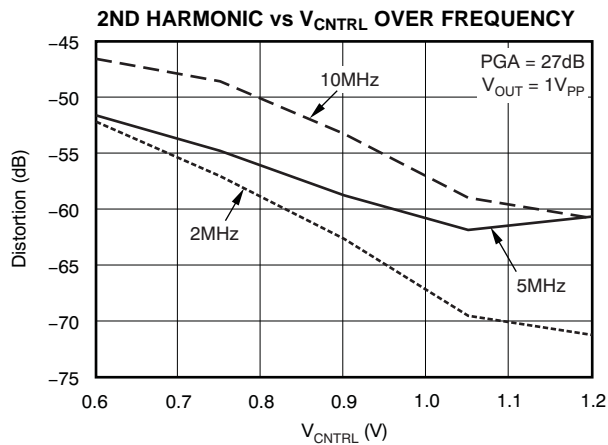

Figure 36.

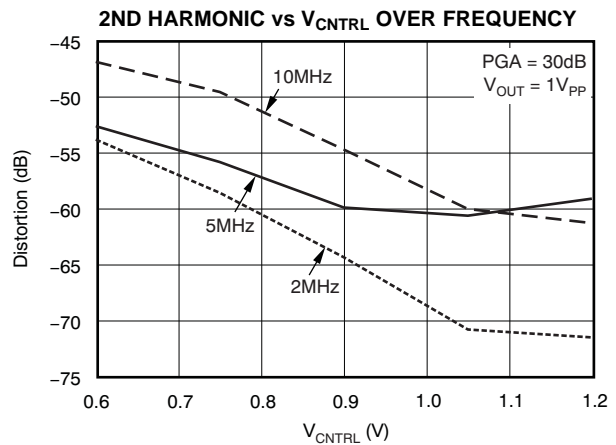

Figure 37.

**TYPICAL CHARACTERISTICS (continued)**

All specifications at  $T_A = +25^\circ\text{C}$ ,  $AVDD2 = 5.0\text{V}$ ,  $AVDD1 = DVDD = 3.3\text{V}$ ; single-ended, ac-coupled ( $1\mu\text{F}$ ) input configuration to the preamp (LNA),  $f_{IN} = 5\text{MHz}$ ,  $V_{CNTRL} = 1.0\text{V}$ , clamp disabled ( $CL = 1$ ),  $LPF = 15\text{MHz}$ , and  $R_{LOAD} = 1\text{k}\Omega$  on each output to ground, unless otherwise noted.

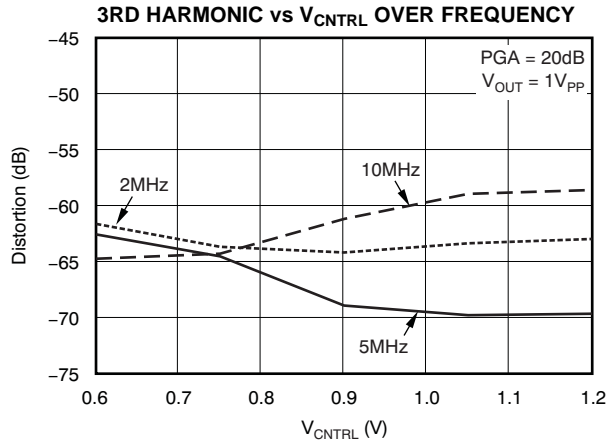

Figure 38.

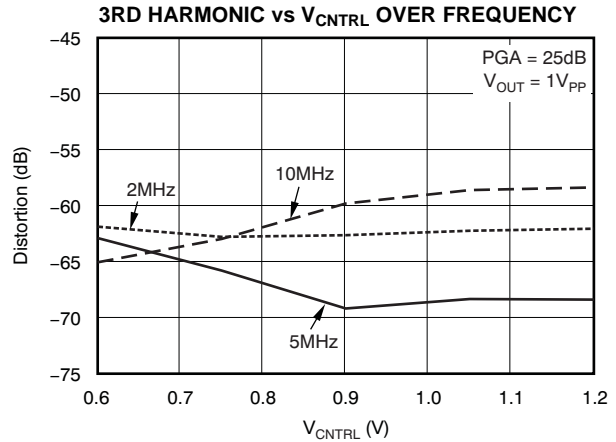

Figure 39.

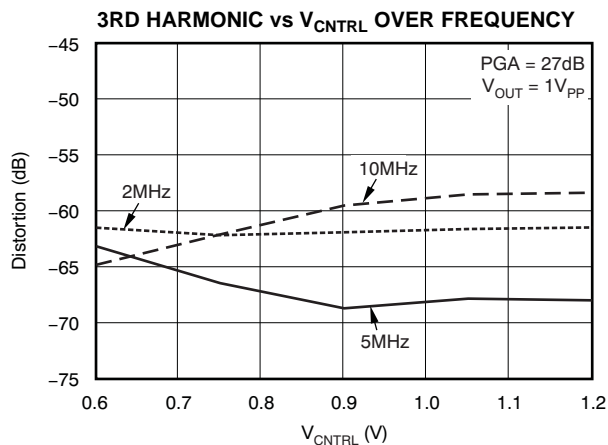

Figure 40.

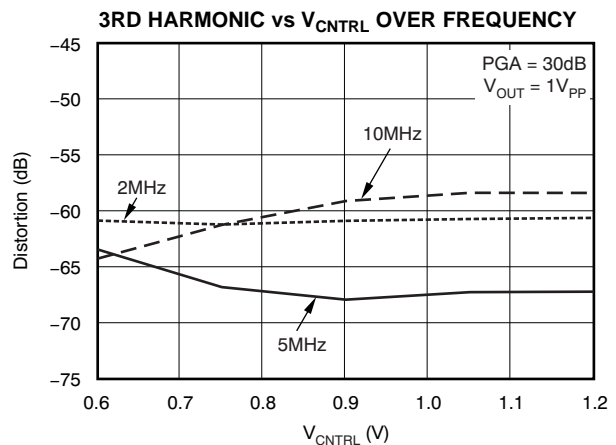

Figure 41.

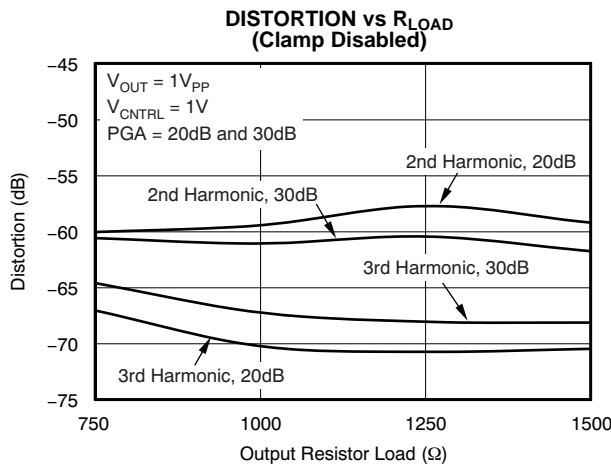

Figure 42.

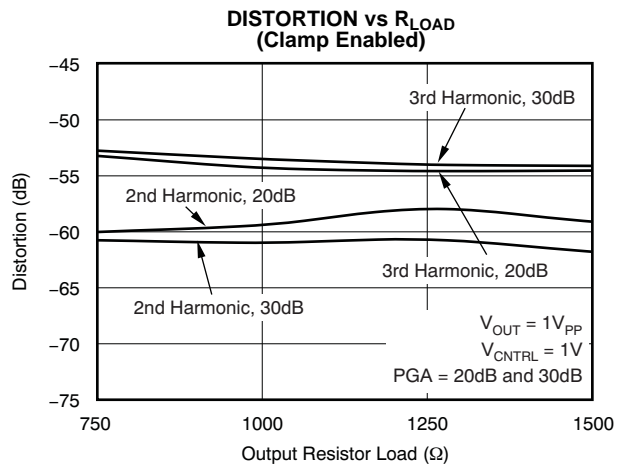

Figure 43.

**TYPICAL CHARACTERISTICS (continued)**

All specifications at  $T_A = +25^\circ\text{C}$ ,  $AVDD2 = 5.0\text{V}$ ,  $AVDD1 = DVDD = 3.3\text{V}$ ; single-ended, ac-coupled ( $1\mu\text{F}$ ) input configuration to the preamp (LNA),  $f_{IN} = 5\text{MHz}$ ,  $V_{CNTRL} = 1.0\text{V}$ , clamp disabled ( $CL = 1$ ),  $LPF = 15\text{MHz}$ , and  $R_{LOAD} = 1\text{k}\Omega$  on each output to ground, unless otherwise noted.

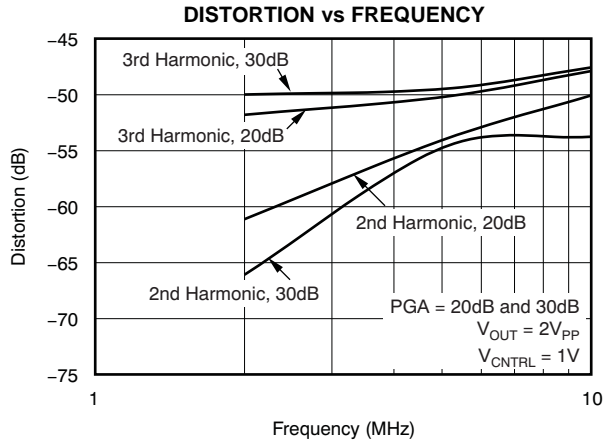

Figure 44.

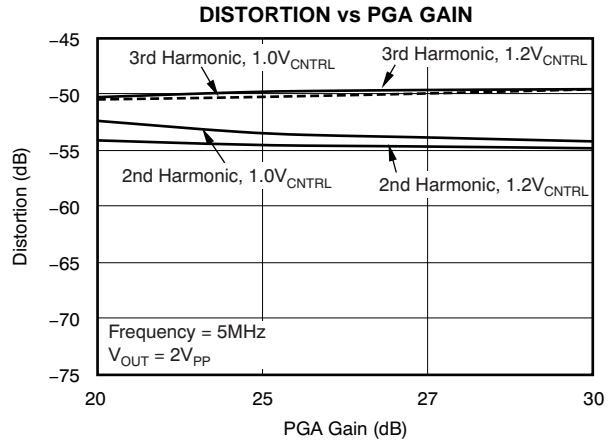

Figure 45.

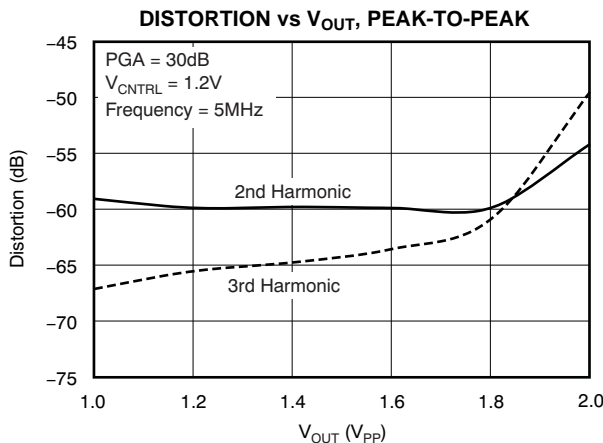

Figure 46.

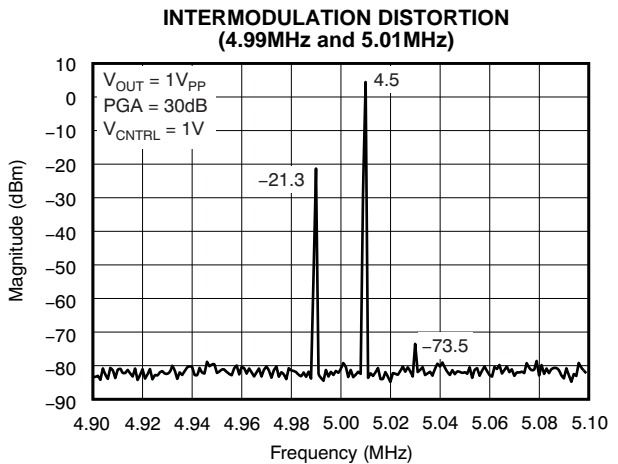

Figure 47.

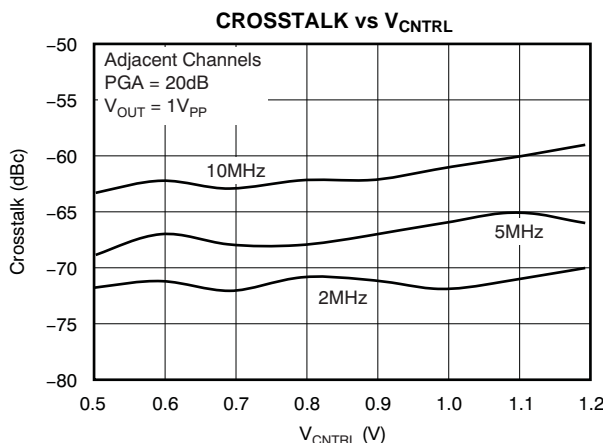

Figure 48.

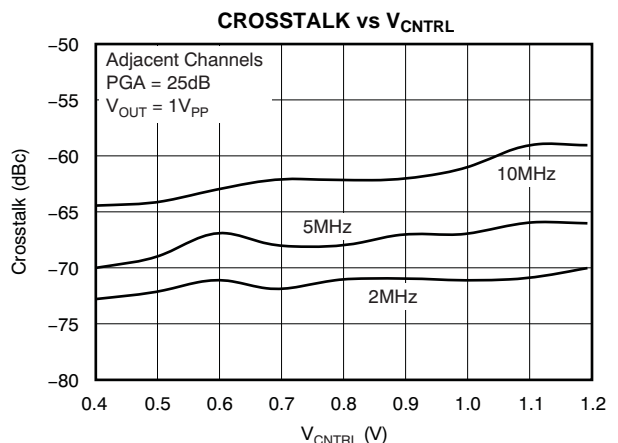

Figure 49.

### TYPICAL CHARACTERISTICS (continued)

All specifications at  $T_A = +25^\circ\text{C}$ ,  $AVDD2 = 5.0\text{V}$ ,  $AVDD1 = DVDD = 3.3\text{V}$ ; single-ended, ac-coupled ( $1\mu\text{F}$ ) input configuration to the preamp (LNA),  $f_{IN} = 5\text{MHz}$ ,  $V_{CNTRL} = 1.0\text{V}$ , clamp disabled ( $CL = 1$ ),  $LPF = 15\text{MHz}$ , and  $R_{LOAD} = 1\text{k}\Omega$  on each output to ground, unless otherwise noted.

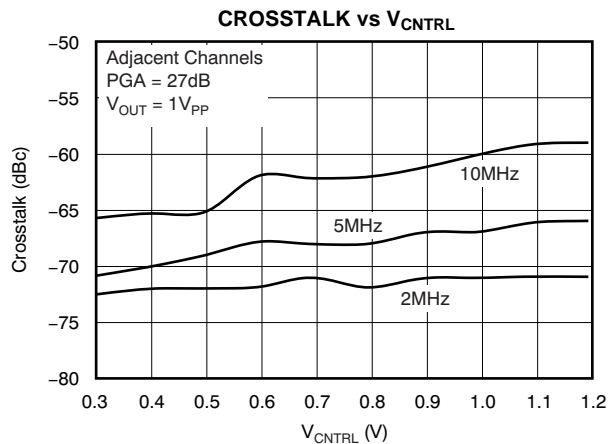

Figure 50.

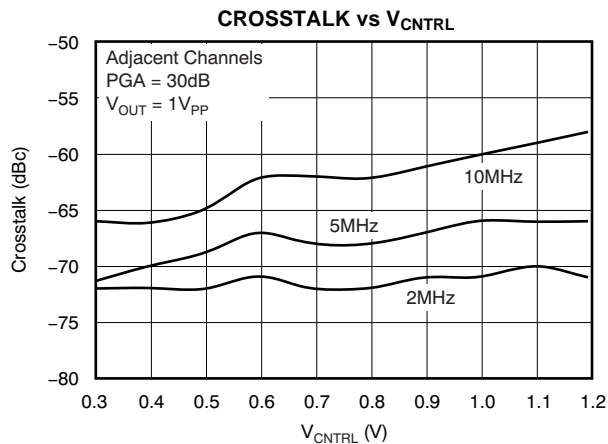

Figure 51.

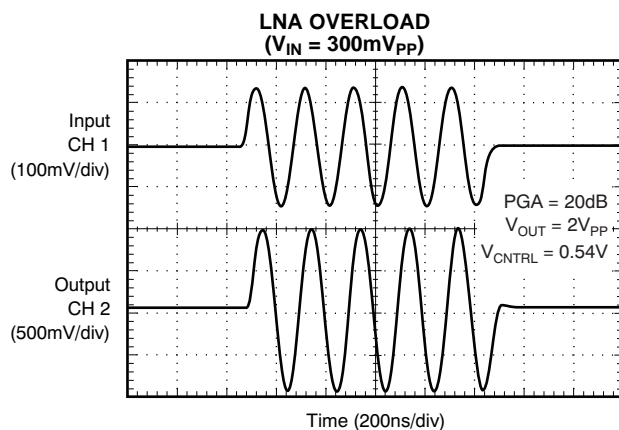

Figure 52.

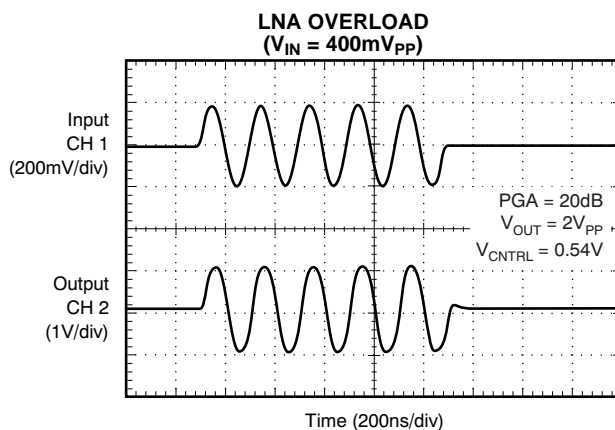

Figure 53.

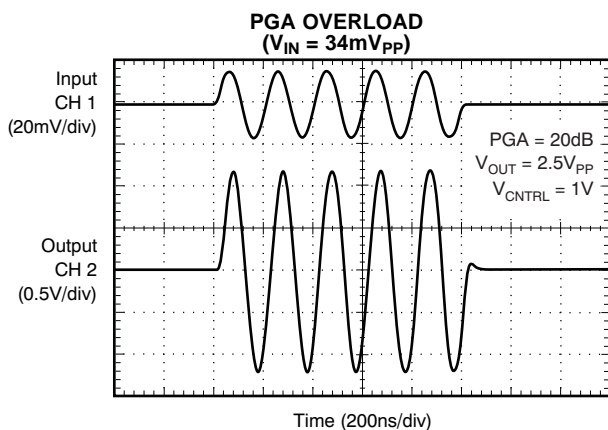

Figure 54.

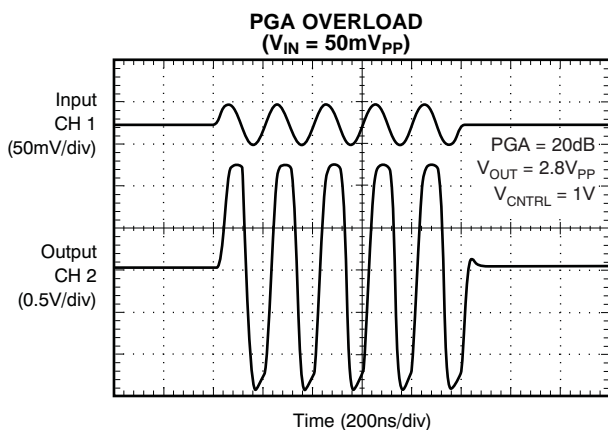
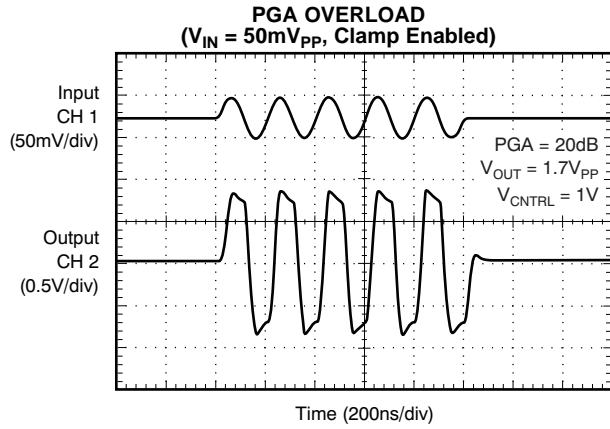

Figure 55.

**TYPICAL CHARACTERISTICS (continued)**

All specifications at  $T_A = +25^\circ\text{C}$ ,  $AVDD2 = 5.0\text{V}$ ,  $AVDD1 = DVDD = 3.3\text{V}$ ; single-ended, ac-coupled ( $1\mu\text{F}$ ) input configuration to the preamp (LNA),  $f_{IN} = 5\text{MHz}$ ,  $V_{CNTRL} = 1.0\text{V}$ , clamp disabled ( $CL = 1$ ), LPF =  $15\text{MHz}$ , and  $R_{LOAD} = 1\text{k}\Omega$  on each output to ground, unless otherwise noted.



**Figure 56.**

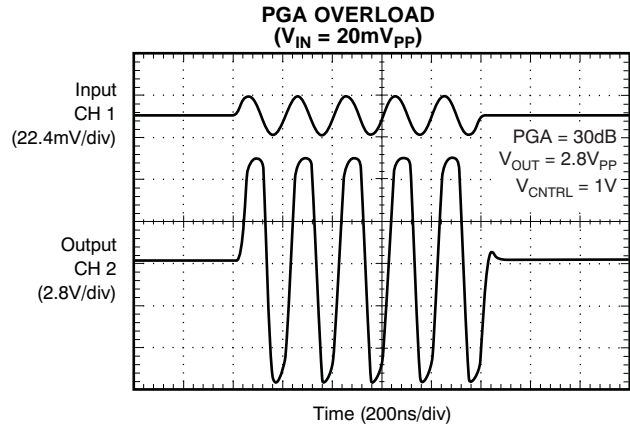

**Figure 57.**

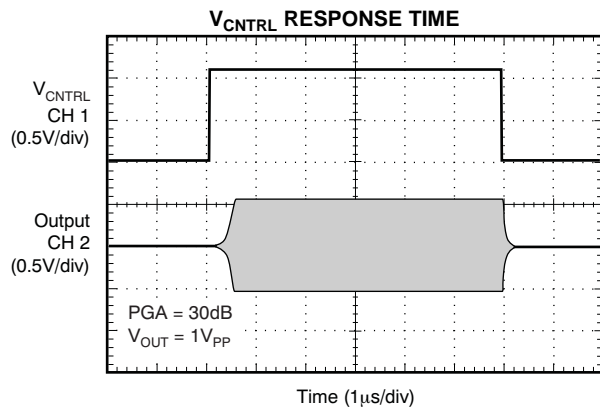

**Figure 58.**

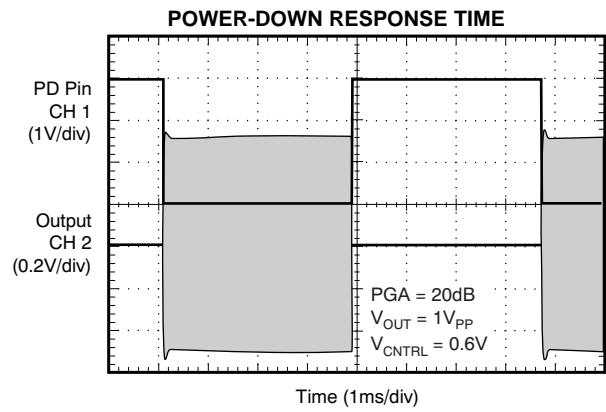

**Figure 59.**

## THEORY OF OPERATION

Built on TI's bipolar-complementary (BiCOM) process, the VCA8500 is a third-generation, octal variable gain amplifier that implements a number of proprietary circuit design techniques to specifically address the performance demands of medical ultrasound systems.

The VCA8500 is an 8-channel VGA that is ideally suited for portable ultrasound applications. It offers unparalleled low-noise and low-power performance at a high level of integration. For the TGC signal path, each channel consists of a 20dB fixed-gain low-noise amplifier (LNA), a linear-in-dB voltage-controlled attenuator (VCA), and a programmable gain amplifier (PGA), as well as a clamping and low-pass filter stage. Digitally controlled through the logic interface, the PGA gain can be set to four different settings: 20dB, 25dB, 27dB, and 30dB. At its highest setting, the total available gain of the VCA8500 is therefore 50dB, sufficient for 10-bit systems. To facilitate the logarithmic time-gain compensation required for ultrasound systems, the VCA is designed to provide a 46dB attenuation range. Here, all channels are simultaneously controlled by an externally-applied control voltage ( $V_{CNTL}$ ) in the range of 0V to 1.2V.

While the LNA is designed to be driven from a single-ended source, the internal TGC signal path is designed to be fully differential to maximize dynamic range while also optimizing for low, even-order harmonic distortion.

CW doppler signal processing is facilitated by routing the differential LNA outputs to V/I amplifier stages. The resulting signal currents of each channel then connect to an 8×10 switch matrix that is controlled through the serial interface and a corresponding register. The CW outputs are typically routed to a passive delay line that allows coherent summing (beam forming) of the active channels and additional off-chip signal processing, as shown in [Figure 60](#).

Applications that do not utilize the CW path can simply operate the VCA8500 in TGC mode. In this mode, the CW blocks (V/I amplifiers and switch matrix) remain powered down, and the CW outputs can be unconnected.

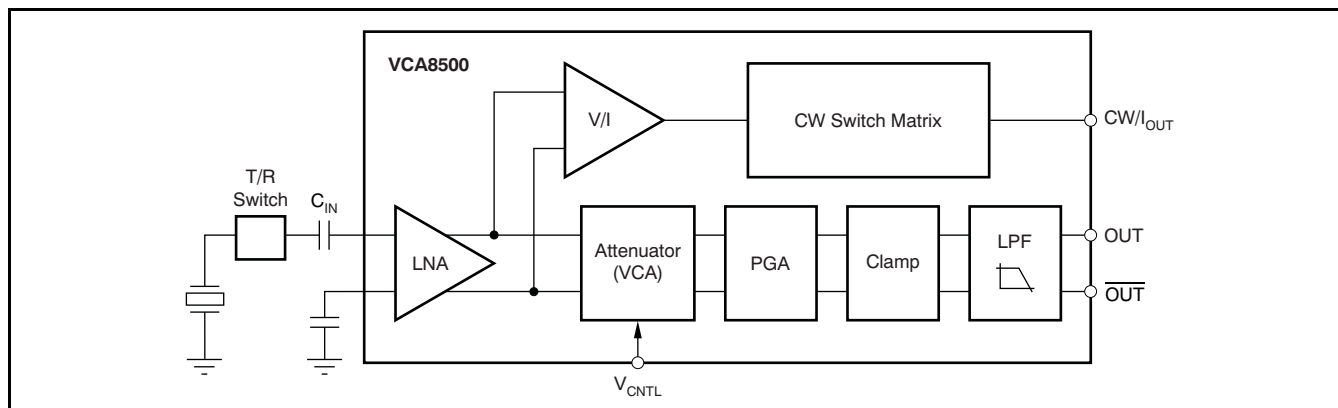

**Figure 60. Functional Block Diagram**

## LOW-NOISE AMPLIFIER (LNA)

As with many high-gain systems, the front-end amplifier is critical to achieve a certain overall performance level. Using a proprietary new architecture, the LNA of the VCA8500 delivers exceptional low-noise performance, while operating on a very low quiescent current of only 8.3mA per channel. This current consumption is significantly lower compared to CMOS-based architectures with similar noise performances.

The LNA performs a single-ended input to differential output voltage conversion and is configured for a fixed gain of 20dB (10V/V). The ultralow input-referred noise of only 0.7nV/ $\sqrt{\text{Hz}}$ , along with the linear input range of 250mV<sub>PP</sub>, results in a wide dynamic range that supports the high demands of PW and CW ultrasound imaging modes. Larger input signals can be accepted by the LNA, but distortion performance degrades as input signals levels increase. The LNA input is internally biased to approximately 2.4V; the signal source should be ac-coupled to the LNA input by an adequately-sized capacitor. Internally, the LNA directly drives the VCA, avoiding the typical drawbacks of ac-coupled architectures, such as slow overload recovery.

## VOLTAGE-CONTROLLED ATTENUATOR (VCA)

The amplified differential signal swing that comes from the LNA is reduced by the subsequent VCA stage. The VCA is designed to have a linear-in-dB attenuation characteristic; that is, the average gain loss in dB is constant for each equal increment of the control voltage ( $V_{\text{CNTRL}}$ ). Figure 61 shows the simplified schematic of this VCA stage.

The attenuator is essentially a variable voltage divider that consists of the series input resistor ( $R_S$ ) and eight identical shunt FETs placed in parallel and controlled by sequentially activated clipping amplifiers (A1 through A8). Each clipping amplifier can be understood as a specialized voltage comparator with a soft transfer characteristic and well-controlled output limit voltage. Reference voltages V1 through V8 are equally spaced over the 0V to 1.2V control voltage range. As the control voltage rises through the input range of each clipping amplifier, the amplifier output rises from 0V (FET completely ON) to  $V_{\text{CM}} - V_T$  (FET nearly OFF), where  $V_{\text{CM}}$  is the common source voltage and  $V_T$  is the threshold voltage of the FET. As each FET approaches its off state and the control voltage continues to rise, the next clipping amplifier/FET combination takes over for the next portion of the piecewise-linear attenuation characteristic.

Thus, low control voltages have most of the FETs turned on, producing maximum signal attenuation. Similarly, high control voltages turn the FETs off, leading to minimal signal attenuation. Therefore, each FET acts to decrease the shunt resistance of the voltage divider formed by  $R_S$  and the parallel FET network.

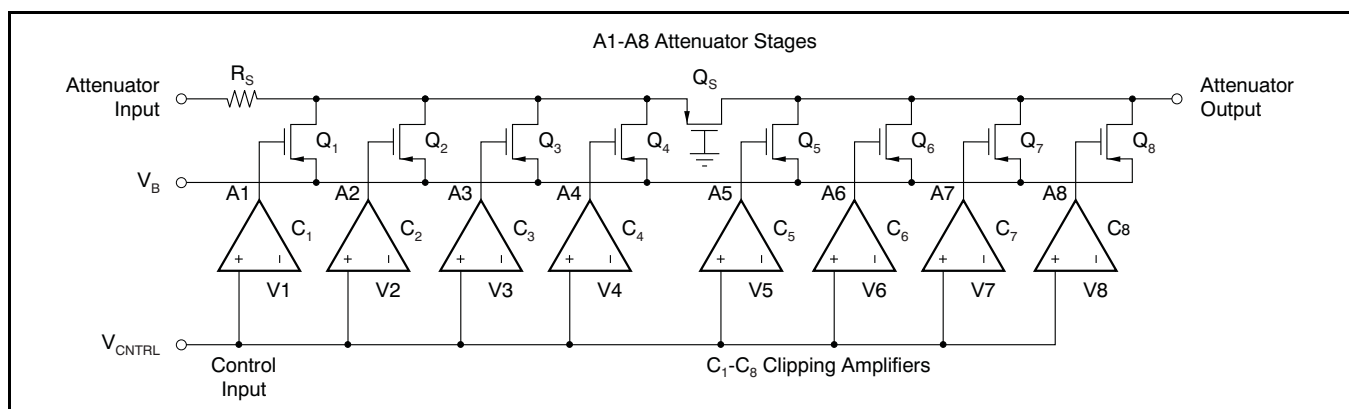

Figure 61. Voltage-Controlled Attenuator Simplified Schematic



## PROGRAMMABLE POST-GAIN AMPLIFIER (PGA)

Following the VCA is a programmable post-gain amplifier (PGA). Figure 62 shows a simplified schematic of the PGA, including the clamping stage. The gain of this PGA can be configured to four different gain settings: 20dB, 25dB, 27dB, and 30dB, programmable through the serial port; see Table 8.

The PGA structure consists of a differential, programmable-gain voltage-to-current converter stage followed by transimpedance amplifiers to create and buffer each side of the differential output. Low input noise is also a requirement for the PGA design as a result of the large amount of signal attenuation that can be applied in the preceding VCA stage. At minimum VCA attenuation (used for small input signals), the LNA noise dominates; at maximum VCA attenuation (large input signals), the attenuator and PGA noise dominates.

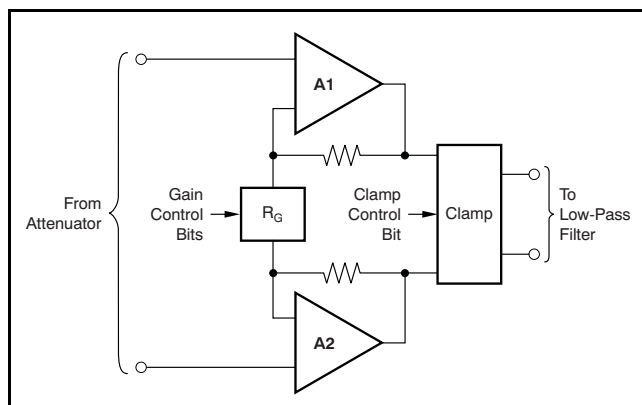

Figure 62. Post-Gain Amplifier (Simplified Schematic)

## PROGRAMMABLE CLAMPING

To further optimize the overload recovery behavior of a complete TGC channel, the VCA8500 integrates a programmable clamping stage, as shown in Figure 63. This clamping stage precedes the low-pass filter in order to prevent the filter circuit from being driven into overload, the result of which would be an extended recovery time. Programmable through the serial interface, the clamping level can be either set to clamp the output to approximately  $1.7V_{PP}$  differential, or be disabled. Disabling the clamp function increases the current consumption on the 3.3V analog supply (AVDD1) by about 3mA for the full device. Note that with the clamp function enabled, the third-harmonic distortion increases.

## LOW-PASS FILTER

As part of a typical data acquisition system, the signal bandwidth generally must be limited by the use of an anti-aliasing filter before the analog-to-digital converter (ADC). The VCA8500 integrates such an anti-aliasing filter in the form of a programmable low-pass filter (LPF) for each channel. The LPF is designed as a differential, active, second-order filter that approximates a Butterworth characteristic, with typically 12dB per octave roll-off. Figure 63 shows the simplified schematic of half the differential active low-pass filter. Programmable through the serial interface, the  $-3$ dB frequency corner can be set to either 10MHz or 15MHz. The filter is set for all channels simultaneously.

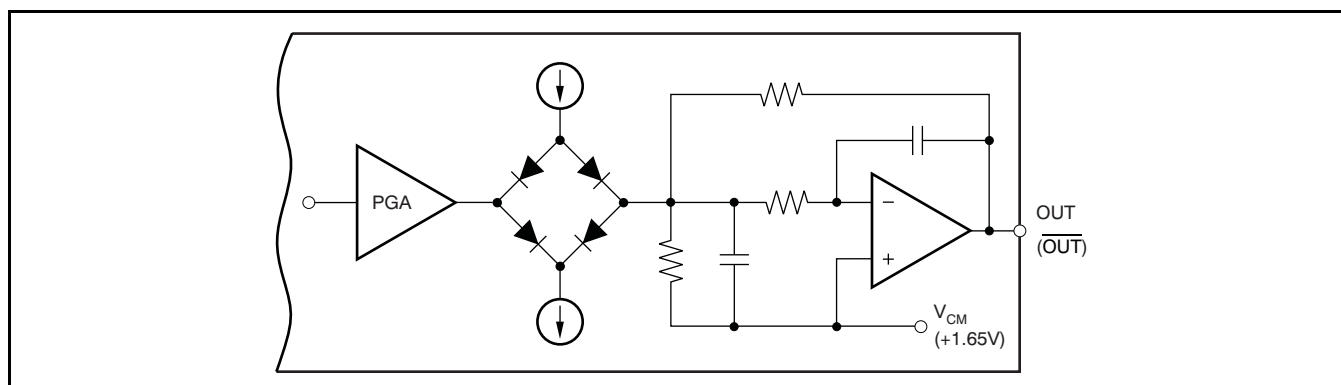

Figure 63. Clamping Stage and Low-Pass Filter (Simplified Schematic)

## APPLICATION INFORMATION

### ANALOG INPUT AND LNA

While the LNA is designed as a fully differential amplifier, it is optimized to perform a single-ended input to differential output conversion. A simplified schematic of an LNA channel is shown in [Figure 64](#). A bias voltage ( $V_B$ ) of +2.4V is internally applied to the LNA inputs through 8k $\Omega$  resistors. In addition, the dedicated signal input (IN pin) includes a pair of back-to-back diodes that provide a coarse input clamping function in case the input signal rises to very large levels, exceeding 0.7V<sub>pp</sub>. This configuration prevents the LNA from being driven into a severe overload state, which may otherwise cause an extended overload recovery time. The integrated diodes are designed to handle a dc current of up to approximately 5mA. Depending on the application requirements, the system overload characteristics may be improved by adding external Schottky diodes at the LNA input, as shown in [Figure 64](#).

As [Figure 64](#) also shows, the complementary LNA input ( $V_{BL}$  pin) is internally decoupled by a small capacitor. Furthermore, for each input channel, a separate  $V_{BL}$  pin is brought out for external bypassing. This bypassing should be done with a small, 0.1 $\mu$ F (typical) ceramic capacitor placed in close proximity to each  $V_{BL}$  pin. Attention should be given to provide a low-noise analog ground for this bypass capacitor. A noisy ground potential may cause noise to be picked up and injected into the signal path, leading to higher noise levels.

The LNA closed-loop architecture is internally compensated for maximum stability without the need of external compensation components (inductors or capacitors). At the same time, the total input capacitance is kept to a minimum with only 30pF.

This architecture minimizes any loading of the signal source that may otherwise lead to a frequency-dependent voltage divider. Moreover, the closed-loop design yields very low offsets and offset drift; this consideration is important because the LNA directly drives the subsequent voltage-controlled attenuator.

The LNA of the VCA8500 uses the benefits of a bipolar process technology to achieve an exceptionally low-noise voltage of 0.7nV/ $\sqrt{\text{Hz}}$ , and a low current noise of only 3pA/ $\sqrt{\text{Hz}}$ . With these input-referred noise specifications, the VCA8500 achieves very low noise figure numbers over a wide range of source resistances and frequencies (see [Figure 26](#) in the Typical Characteristics). The optimal noise power matching is achieved for source impedances of around 200 $\Omega$ .

Further details of the VCA8500 input and output noise performance are shown in the [Typical Characteristic](#) graphs; the input-referred noise voltage is derived by dividing the output-referred noise by the measured gain at each point along the gain control range.

#### Noise Figure versus Source Resistance ( $R_S$ )

$R_S$ ( $\Omega$ )	NOISE FIGURE (dB)
50	2.21
200	1.10
400	1.14
1000	2.06

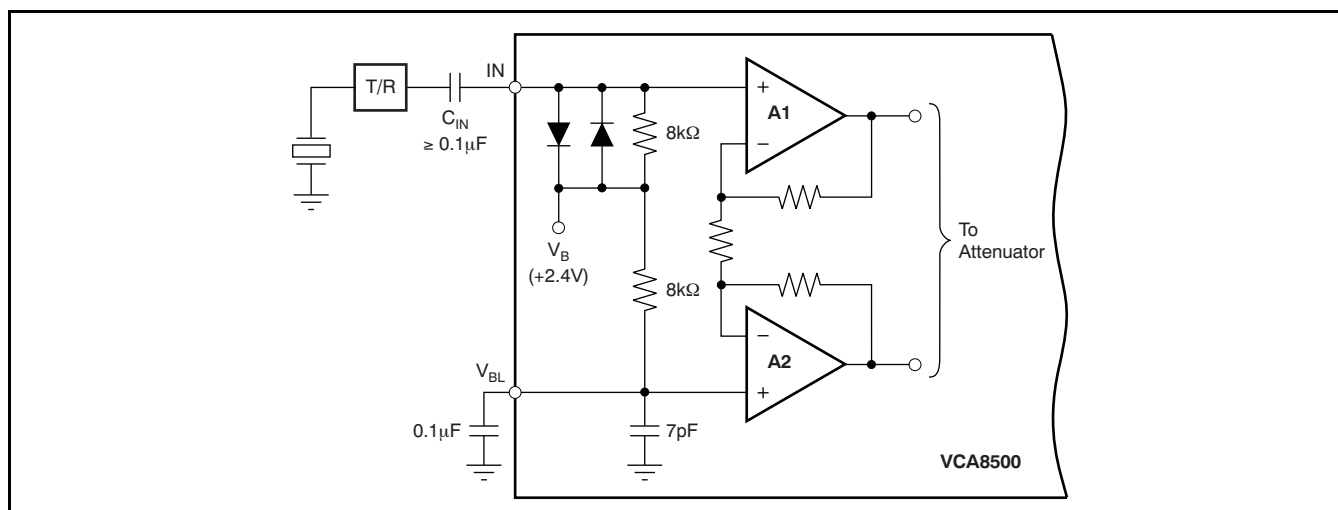

**Figure 64. LNA Channel (Simplified Schematic)**

## OVERLOAD RECOVERY

The VCA8500 is designed in particular for ultrasound applications where the front-end device is required to recover very quickly from an overload condition. Such an overload can either be the result of a transmit pulse feed-through or a strong echo, which can cause overload of the LNA, the PGA, or both. As discussed earlier, the LNA inputs are internally protected by a pair of back-to-back diodes to prevent severe overload of the LNA. [Figure 65](#) illustrates an ultrasound receive channel front-end that includes typical external overload protection elements. Here, four high-voltage switching diodes are configured in a bridge configuration and form the transmit/receive (T/R) switch. During the transmit period, high voltage pulses from the pulser are applied to the transducer elements and the T/R switch isolates the sensitive LNA input from being damaged by the high voltage signal. However, it is common that fast transients up to several volts leak through the T/R switch and potentially overload the receiver. Therefore, an additional pair of clamping diodes is placed between the T/R switch and the LNA input. In order to clamp the over-voltage to small levels, Schottky diodes (such as the BAS40 series by Infineon®) are commonly used. For example, clamping to levels of  $\pm 0.3\text{V}$  can significantly reduce the overall overload recovery performance. The T/R switch characteristics

are largely determined by the biasing current of the diodes, which can be set by adjusting the  $3\text{k}\Omega$  resistor values; for example, setting a higher current level may lead to an improved switching characteristic and reduced noise contribution. A typical front-end protection circuitry may add in the order of  $2\text{nV}/\sqrt{\text{Hz}}$  of noise to the signal path. This slight increase also depends on the value of the termination resistor ( $R_T$ ).

As [Figure 65](#) shows, the front-end circuitry should be capacitively coupled to the LNA signal input (IN). This coupling ensures that the LNA input bias voltage of  $+2.4\text{V}$  is maintained and decoupled from any other biasing voltage before the LNA.

Within the VCA8500, overload can occur in either the LNA or the PGA. LNA overload can occur as the result of T/R switch feed-through; and the PGA can be driven into an overload condition by a strong echo in the near-field while the signal gain is high. In any case, the VCA8500 is optimized for very short recovery times, as shown in [Figure 65](#).

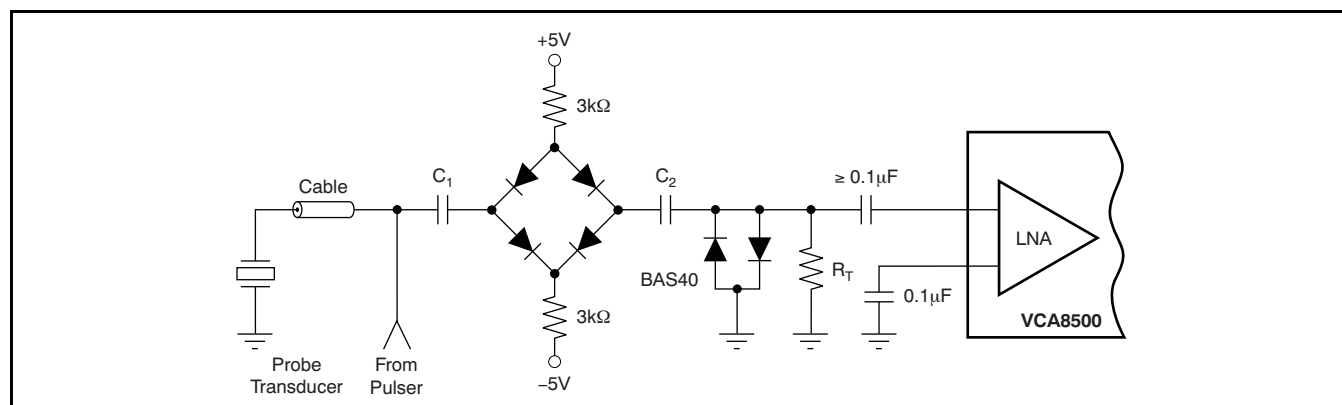

**Figure 65. Typical Input Overload Protection Circuit of an Ultrasound System**

## VCA—GAIN CONTROL

The attenuator (VCA) for each of the eight channels of the VCA8500 is controlled by a single-ended control signal input, the  $V_{\text{CNTRL}}$  pin. The control voltage range spans from 0V to 1.2V, referenced to ground. This control voltage varies the attenuation of the VCA based on its linear-in-dB characteristic with its maximum attenuation (minimum gain) at  $V_{\text{CNTRL}} = 0\text{V}$ , and minimum attenuation (maximum gain) at  $V_{\text{CNTRL}} = 1.2\text{V}$ . Table 12 shows the nominal gains for each of the four PGA gain settings. The total gain range is typically 46dB and remains constant independent of the PGA selected; the *Max Gain* column reflects the absolute gain of the full signal path comprised of the fixed LNA gain of 20dB and the programmable PGA gain.

**Table 12. Nominal Gain Control Ranges for Each of the Four PGA Gain Settings**

PGA GAIN	MIN GAIN AT $V_{\text{CNTRL}} = 0\text{V}$	MAX GAIN AT $V_{\text{CNTRL}} = 1.2\text{V}$
20dB	-4.5dB	41.5dB
25dB	-0.5dB	45.5dB
27dB	1.5dB	47.5dB
30dB	3.5dB	49.5dB

As previously discussed, the VCA architecture uses eight attenuator segments that are equally spaced in order to approximate the linear-in-dB gain-control slope. This approximation results in a monotonic slope; gain ripple is typically less than  $\pm 0.5\text{dB}$ .

The VCA8500 gain-control input has a -3dB bandwidth of approximately 1.5MHz. This wide bandwidth, although useful in many applications, can allow high-frequency noise to modulate the gain control input. In practice, this modulation can easily be avoided by additional external filtering ( $R_F$  and  $C_F$ ) of the control input, as Figure 66 shows. Stepping the control voltage from 0V to 1.2V, the gain control response time is typically less than 500ns to settle within 10% of the final signal level of a  $1V_{\text{PP}}$  output.

The control voltage input ( $V_{\text{CNTRL}}$  pin) represents a high-impedance input. Multiple VCA8500 devices can be connected in parallel with no significant loading effects using the  $V_{\text{CNTRL}}$  pin of each device. Note that when the  $V_{\text{CNTRL}}$  pin is left unconnected, it floats up to a potential of about +3.7V. For any voltage level above 1.2V and up to 5.0V, the VCA continues to operate at its minimum attenuation level; however, it is recommended to limit the voltage to approximately 1.5V or less.

When the VCA8500 operates in CW mode, the attenuator stage remains connected to the LNA outputs. Therefore, it is recommended to set the  $V_{\text{CNTRL}}$  voltage to +1.2V in order to minimize the internal loading of the LNA outputs. Small improvements in reduced power dissipation and improved distortion performance may also be realized.

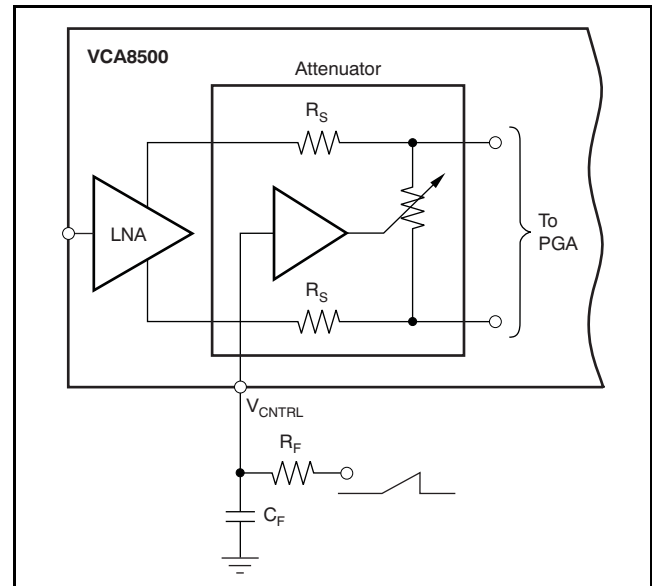

**Figure 66. External Filtering of the  $V_{\text{CNTRL}}$  Input**

## OUTPUT

The output stage of the VCA8500 delivers a differential output signal that swings symmetrically around a fixed common-mode output voltage of +1.65V. The design of the output stage includes a common-mode control loop to hold the output common-mode voltage stable over a wide range of operating conditions. At the same time the output offset and drift are kept to a minimum, allowing the VCA8500 to be dc-coupled directly to other devices (such as an ADC). In cases where the output of the VCA8500 drives devices with a non-matching input common-mode level, small ac-coupling capacitors (for instance, 0.1 $\mu\text{F}$ ) should be used.

It should be noted, however, that unlike many other high-speed operational amplifiers, the VCA8500 is designed to drive a typical output load of 1k $\Omega$  single-ended (from each output to ground) or 2k $\Omega$  differentially. For most applications, this consideration should not represent a limitation; many high-speed ADCs have input impedances in the k $\Omega$  range. For the VCA8500 to maintain the ability to provide the full  $2V_{\text{PP}}$  output swing, however, it is recommended to keep the output loading to 800 $\Omega$ , single-ended (1.6k $\Omega$  differential), or higher. In addition, care should be taken to keep the capacitive loading of the outputs to

a minimum ( $C_{LOAD} \leq 18\text{pF}$ , differential). The user should examine all factors that contribute to the total load ( $R_{L\text{TOTAL}} = R_L + X_L$ ). Depending on the overall system requirements, trade-offs can be made between the output loading and the desired distortion levels and output swing.

## INTERFACING TO ADCs

The VCA8500 is ideally suited to drive the [ADS5281](#), a low-power, octal, 12-bit ADC that can be operated at sampling rates of up to 50MSPS. The VCA outputs can be directly connected the ADC inputs without the need for any external components, as shown in [Figure 67](#). Observing proper layout considerations, the two devices can be placed in close proximity to each other and allow for a very compact printed circuit board (PCB) layout.

The ADS5281 features many performance characteristics that make it an excellent choice for ultrasound systems: low channel power of only 55mW/ch (at 40MSPS); high signal-to-noise ratio of 70dB; and fast overload recovery time of only one clock cycle. The VCA8500 can be configured to complement this level of performance by choosing the most suitable amplification setting of the post-gain amplifier. For example, the ADS5281 has a full-scale input of  $2V_{PP}$  and an input-referred noise of approximately  $50\text{nV}/\sqrt{\text{Hz}}$ . In order to achieve the highest combined dynamic range performance, the PGA gain can be set to 20dB. With this gain setting, the output-referred noise is dominated by the noise contribution of the attenuator and PGA and remains constant over most of the gain control range (approximately  $65\text{nV}/\sqrt{\text{Hz}}$ ). Only at the high end of the gain control range does the LNA and source-related noise contribution become the prevailing factor. Higher gain PGA settings may be chosen to interface to lower resolution ADCs that have a higher noise floor.

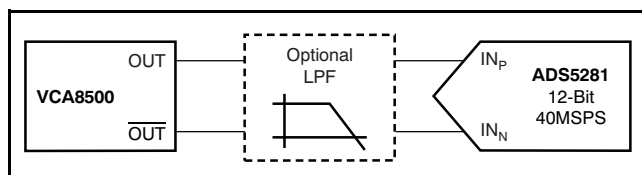

**Figure 67. The VCA8500 Can Be Interfaced to the ADS5281 Without the Need for External Components**

[Figure 68](#) shows the normalized frequency response of the low-pass filter. The 15MHz bandwidth is intended to be the upper bandwidth for a system that

uses sampling rates of up to 40MSPS. Here, the ratio of the bandwidth (BW) to the Nyquist frequency ( $f_S/2$ ) is approximately 0.75, which provides a good compromise between the passband area and the stop band attenuation. Choosing the lower 10MHz bandwidth setting may be considered if the sampling rate is reduced further, or if the input signal bandwidth is lower. In this case, the reduced noise bandwidth can potentially improve the noise floor.

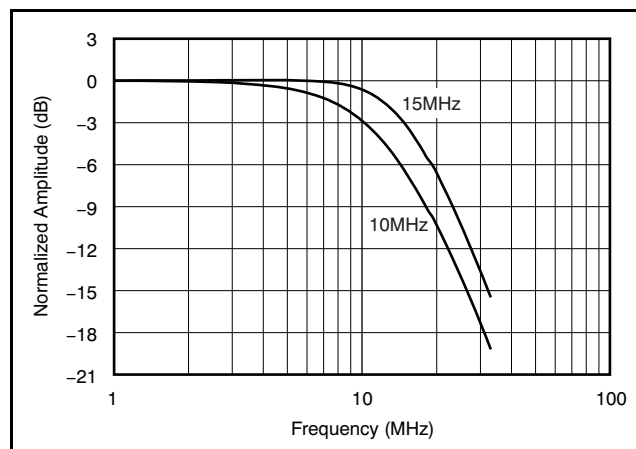

**Figure 68. Normalized Frequency Response of the 10MHz and 15MHz Low-Pass Filter**

## CW DOPPLER PROCESSING

The VCA8500 integrates many of the elements necessary to allow for the implementation of a CW doppler processing circuit, such as a V/I converter for each channel and a cross-point switch matrix with an 8-input into 10-output (8×10) configuration.

In order to switch the VCA8500 from the default TGC mode operation into CW mode, bit D5 of the control register must be updated to low ('0'). This setting also enables access to all other registers that determine the switch matrix configuration (see the [Input Register Bit Map](#) tables). In order to process CW signals, the LNA internally feeds into a differential V/I amplifier stage. The transconductance of the V/I amplifier is typically 16.4mA/V with a 100mV<sub>PP</sub> input signal. For proper operation, the CW outputs must be connected to an external bias voltage of +2.5V. Each CW output is designed to sink a small dc current of 0.9mA, and can deliver a signal current up to 2.9mA<sub>PP</sub>.

The resulting signal current then passes through the 8×10 switch matrix. Depending on the programmed configuration of the switch matrix, any V/I amplifier current output can be connected to any of 10 CW outputs. This design is a simple current-summing circuit such that each CW output can represent the sum of any or all of the channel currents. The CW outputs are typically routed to a passive LC delay line, allowing coherent summing of the signals.

After summing, the CW signal path further consists of a high dynamic range mixer for down-conversion to I/Q base-band signals. The I/Q signals are then band-limited (that is, low-frequency contents are removed) in a filter stage that precedes a pair of high-resolution, low sample rate ADCs.

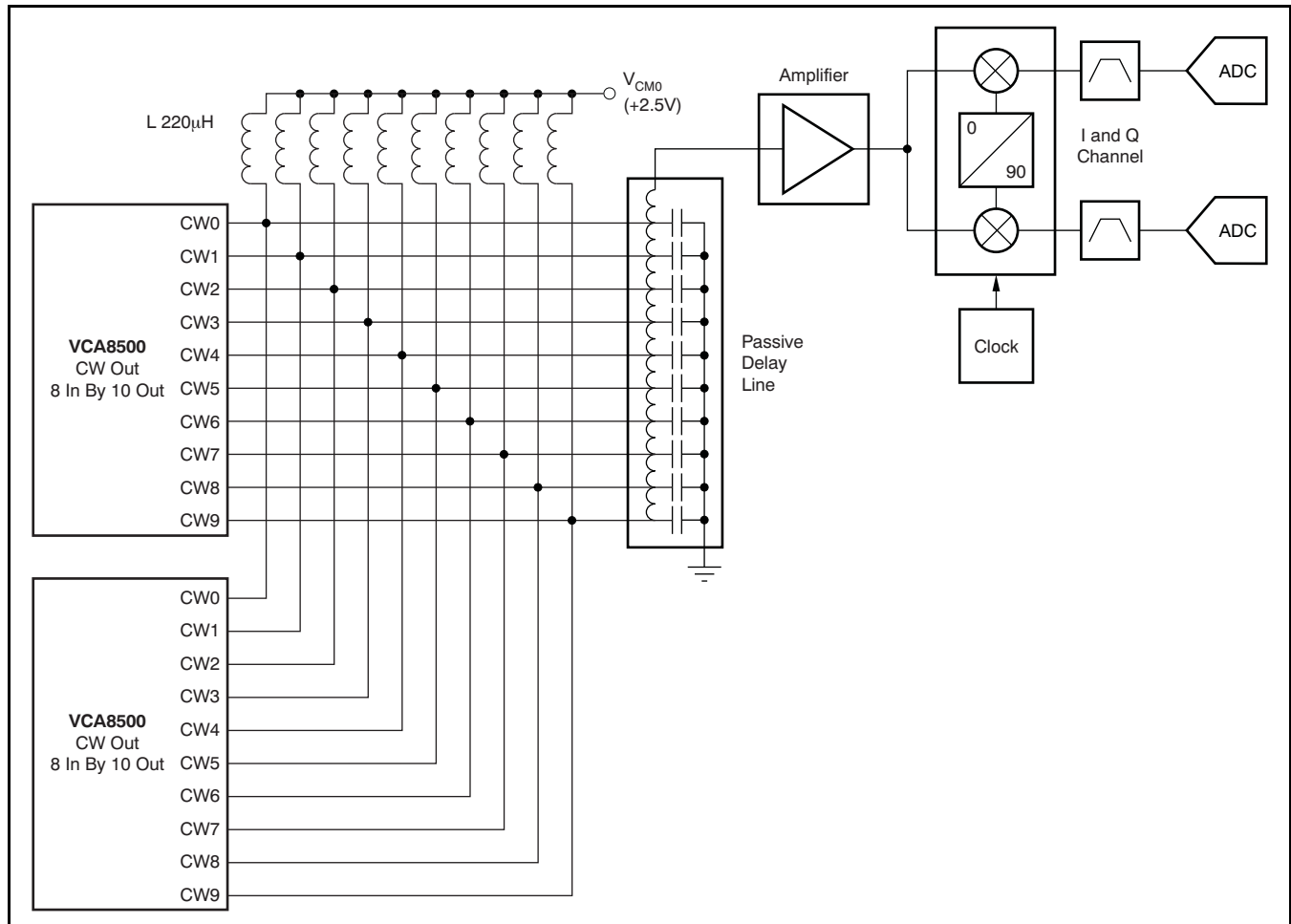

Figure 69. Conceptual CW Doppler Signal Path Using Current Summing and a Passive Delay Line for Beamforming

## POWER SUPPLIES

The VCA8500 operates on two supply rails, a +3.3V and a +5V supply. At initial power-up, the part operates in the TGC mode, with the registers in the default configurations (see [Table 2](#)).

In TGC mode, only the VCA (attenuator) draws a small current (typically 1.5mA) from the +5V supply. Switching into the CW mode, the internal V/I amplifiers are then powered from the +5V rails as well, raising the operating current on the +5V rail. At the same time, the post-gain amplifiers (PGA) are powered down, reducing the current consumption on the +3.3V rail (refer to the [Electrical Characteristics](#) table for details).

All supply rails for the VCA8500 should be clean, low-noise, analog supplies. This consideration includes the +3.3V digital supply DVDD (pin 59) that connects to the internal logic blocks of the VCA8500. It is recommended to tie the DVDD pin to the same +3.3V analog supply as the AVDD1 pins, rather than a different +3.3V rail that may also power other logic devices in the system. Transients and noise generated by those devices can couple into the VCA8500 and degrade performance.

While the VCA8500 uses a thermally-enhanced QFN package that includes a PowerPAD on its backside, the primary function of the PowerPAD is to provide a solid ground reference point. Care should be taken to use this package pad during the PCB layout phase as the main ground return point.

## POWER-DOWN MODES

The VCA8500 features two power-down modes—a standby mode and a shutdown mode. The standby mode function allows the VCA8500 to be rapidly placed in a low-power state. When in this mode, most amplifiers in the signal path are powered-down, while the internal references remain active. This state ensures that the external bypass capacitors retain the

respective charges, minimizing the wake-up response time. As an example, [Figure 59](#) illustrates the standby power-up/down response when the PD pin is toggled with a period of approximately 7.7ms (130Hz) with a 50% duty cycle. Here, the wake-up response time is approximately 40 $\mu$ s, while the power-down time is instantaneous ( $\leq 0.2\mu$ s). Factors such as the control voltage setting, input signal level, PD pin toggle time, and duty cycle primarily affect the wake-up response time. Therefore, the user should evaluate the VCA8500 performance under the desired system conditions.

When in standby mode, the part typically dissipates only 104mW, representing an 80% power reduction compared to the normal operating mode. This function is controlled through the PD pin (pin 49), which is designed to interface to +3.3V low-voltage logic. For normal operation, the PD pin should be tied to a logic low ('0'); pulling this pin high ('1') places the VCA into standby mode.

To achieve the lowest power dissipation of only 19mW, the VCA8500 can be placed in shutdown mode. This mode is controlled through the serial interface by setting bit D2 (PWR) of the control register to '1'. When in shutdown mode, all circuits (including references) within the VCA8500 are powered-down, causing the bypass capacitors to be discharged. Consequently, the wake-up time depends largely on the time needed to charge the bypass capacitors back up. Another factor is the elapsed time the VCA8500 spends in shutdown mode.

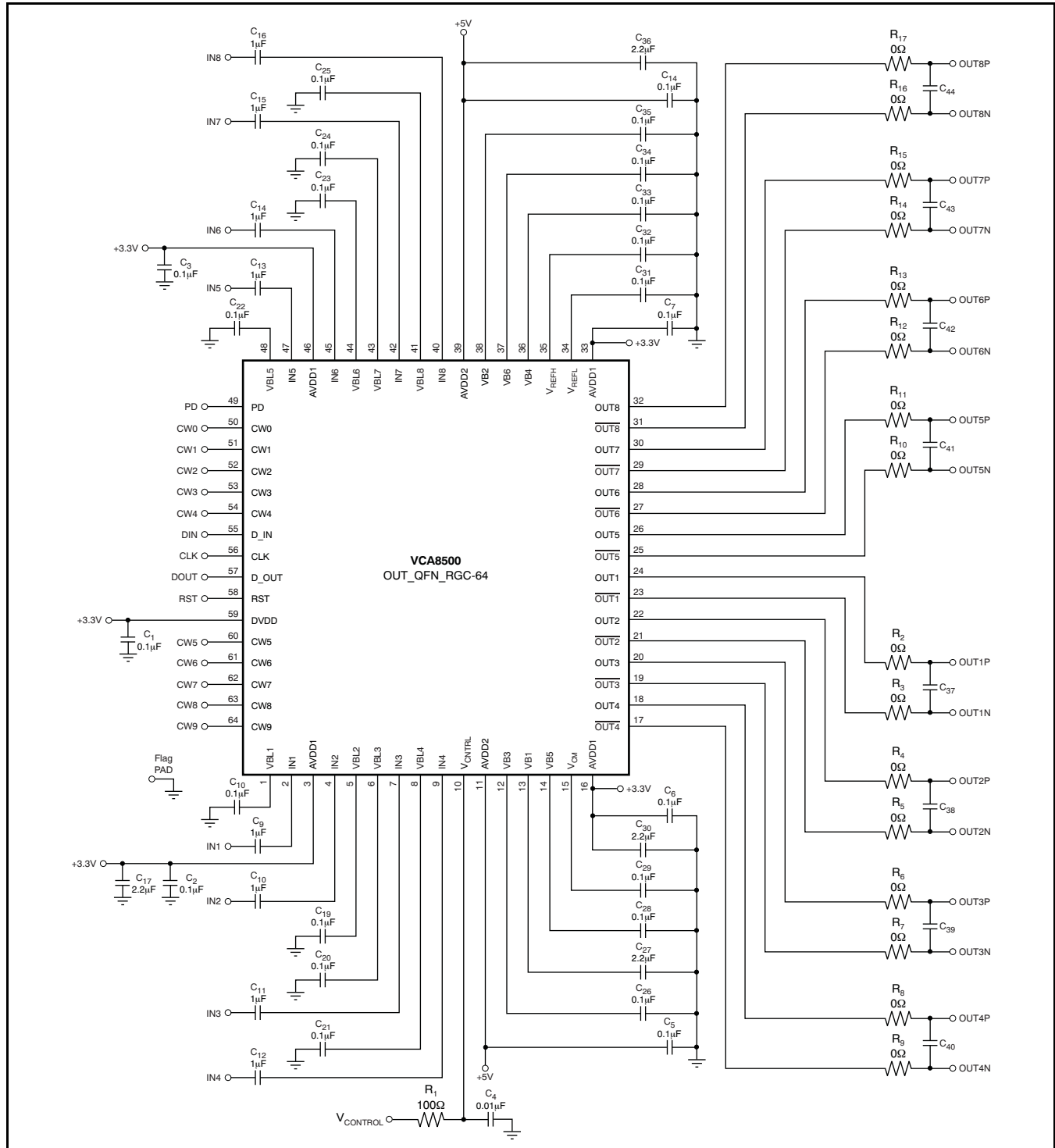

- (1) V<sub>CONTROL</sub>: Values for R<sub>1</sub> and C<sub>4</sub> should be selected for a desired time constant.
- (2) Optional components: Values for R<sub>2</sub> to R<sub>17</sub> and C<sub>37</sub> to C<sub>44</sub> should be selected based on the analog-to-digital converter selected.
- (3) The +3.3V supply connections for DVDD and AVDD1 should be joined to a low-noise +3.3V system supply. Consider filtering any supply noise with an LC filter.

**Figure 70. Typical Connection Diagram**



## GROUNDING AND BYPASSING

The VCA8500 uses a thermally-enhanced QFN package, with an exposed PowerPAD on the back side of the package. This backside pad is the only ground reference point of the VCA8500, and it should be connected to a low-noise system ground plane. All bypassing and power supplies for the VCA8500 should be referenced to this ground point.

All supply pins should be bypassed with 0.1 $\mu$ F ceramic chip capacitors (size 0603 or smaller). In order to minimize lead and trace inductance, the capacitors should be located as close to the supply pins as possible. Where double-sided component mounting is allowed, these capacitors are best placed directly under the package. In addition, larger bipolar decoupling capacitors (2.2 $\mu$ F to 10 $\mu$ F), effective at lower frequencies, may also be used on the main supply pins. They can be placed on the PCB in proximity to (less than 0.5in, or 12.7mm from) the VCA8500.

The VCA8500 internally generates a number of reference voltages, such as the bias voltages (VB1 through VB6). Note that in order to achieve the best low-noise performance, VB1 (pin 13) must be bypassed with a capacitor value of at least 1 $\mu$ F; the recommended value is 2.2 $\mu$ F. All other designated

reference pins can be bypassed with smaller capacitor values, typically 0.1 $\mu$ F. For best results choose low-inductance ceramic chip capacitors (size 402) and place them as close to the device pins as possible.

## BOARD LAYOUT

Proper grounding and bypassing, short lead length, and the use of ground planes are particularly important for high-frequency designs. Achieving optimum performance with a high gain amplifier such as the VCA8500 requires careful attention to the PCB layout to minimize the effect of board parasitics and optimize component placement. A multilayer PCB usually ensures best results and allows convenient component placement.

More details on the PowerPAD PCB layout and assembly process can be found in the Texas Instruments Application Reports, *Power-Pad Thermally-Enhanced Package* (SLMA002), and *QFN/SON PCB Attachment* (SLUA271A). These documents can be downloaded from the TI web site ([www.ti.com](http://www.ti.com)).

**PACKAGING INFORMATION**

Orderable Device	Status <sup>(1)</sup>	Package Type	Package Drawing	Pins	Package Qty	Eco Plan <sup>(2)</sup>	Lead/Ball Finish	MSL Peak Temp <sup>(3)</sup>
VCA8500IRGCR	ACTIVE	VQFN	RGC	64	2000	Green (RoHS & no Sb/Br)	CU NIPDAU	Level-3-260C-168 HR
VCA8500IRGCRG4	ACTIVE	VQFN	RGC	64	2000	Green (RoHS & no Sb/Br)	CU NIPDAU	Level-3-260C-168 HR
VCA8500IRGCT	ACTIVE	VQFN	RGC	64	250	Green (RoHS & no Sb/Br)	CU NIPDAU	Level-3-260C-168 HR
VCA8500IRGCTG4	ACTIVE	VQFN	RGC	64	250	Green (RoHS & no Sb/Br)	CU NIPDAU	Level-3-260C-168 HR

<sup>(1)</sup> The marketing status values are defined as follows:

**ACTIVE:** Product device recommended for new designs.

**LIFEBUY:** TI has announced that the device will be discontinued, and a lifetime-buy period is in effect.

**NRND:** Not recommended for new designs. Device is in production to support existing customers, but TI does not recommend using this part in a new design.

**PREVIEW:** Device has been announced but is not in production. Samples may or may not be available.

**OBSOLETE:** TI has discontinued the production of the device.

<sup>(2)</sup> Eco Plan - The planned eco-friendly classification: Pb-Free (RoHS), Pb-Free (RoHS Exempt), or Green (RoHS & no Sb/Br) - please check <http://www.ti.com/productcontent> for the latest availability information and additional product content details.

**TBD:** The Pb-Free/Green conversion plan has not been defined.

**Pb-Free (RoHS):** TI's terms "Lead-Free" or "Pb-Free" mean semiconductor products that are compatible with the current RoHS requirements for all 6 substances, including the requirement that lead not exceed 0.1% by weight in homogeneous materials. Where designed to be soldered at high temperatures, TI Pb-Free products are suitable for use in specified lead-free processes.

**Pb-Free (RoHS Exempt):** This component has a RoHS exemption for either 1) lead-based flip-chip solder bumps used between the die and package, or 2) lead-based die adhesive used between the die and leadframe. The component is otherwise considered Pb-Free (RoHS compatible) as defined above.

**Green (RoHS & no Sb/Br):** TI defines "Green" to mean Pb-Free (RoHS compatible), and free of Bromine (Br) and Antimony (Sb) based flame retardants (Br or Sb do not exceed 0.1% by weight in homogeneous material)

<sup>(3)</sup> MSL, Peak Temp. -- The Moisture Sensitivity Level rating according to the JEDEC industry standard classifications, and peak solder temperature.

**Important Information and Disclaimer:**The information provided on this page represents TI's knowledge and belief as of the date that it is provided. TI bases its knowledge and belief on information provided by third parties, and makes no representation or warranty as to the accuracy of such information. Efforts are underway to better integrate information from third parties. TI has taken and continues to take reasonable steps to provide representative and accurate information but may not have conducted destructive testing or chemical analysis on incoming materials and chemicals. TI and TI suppliers consider certain information to be proprietary, and thus CAS numbers and other limited information may not be available for release.

In no event shall TI's liability arising out of such information exceed the total purchase price of the TI part(s) at issue in this document sold by TI to Customer on an annual basis.

**TAPE AND REEL INFORMATION**
**REEL DIMENSIONS**

**TAPE DIMENSIONS**

A0	Dimension designed to accommodate the component width
B0	Dimension designed to accommodate the component length
K0	Dimension designed to accommodate the component thickness
W	Overall width of the carrier tape
P1	Pitch between successive cavity centers

**TAPE AND REEL INFORMATION**

\*All dimensions are nominal

Device	Package Type	Package Drawing	Pins	SPQ	Reel Diameter (mm)	Reel Width W1 (mm)	A0 (mm)	B0 (mm)	K0 (mm)	P1 (mm)	W (mm)	Pin1 Quadrant
VCA8500IRGCR	VQFN	RGC	64	2000	330.0	16.4	9.3	9.3	1.5	12.0	16.0	Q2
VCA8500IRGCT	VQFN	RGC	64	250	330.0	16.4	9.3	9.3	1.5	12.0	16.0	Q2

**TAPE AND REEL BOX DIMENSIONS**

\*All dimensions are nominal

Device	Package Type	Package Drawing	Pins	SPQ	Length (mm)	Width (mm)	Height (mm)
VCA8500IRGCR	VQFN	RGC	64	2000	336.6	336.6	28.6
VCA8500IRGCT	VQFN	RGC	64	250	336.6	336.6	28.6

# MECHANICAL DATA

RGC(S-PVQFN-N64) CUSTOM DEVICE PLASTIC QUAD FLATPACK NO-LEAD

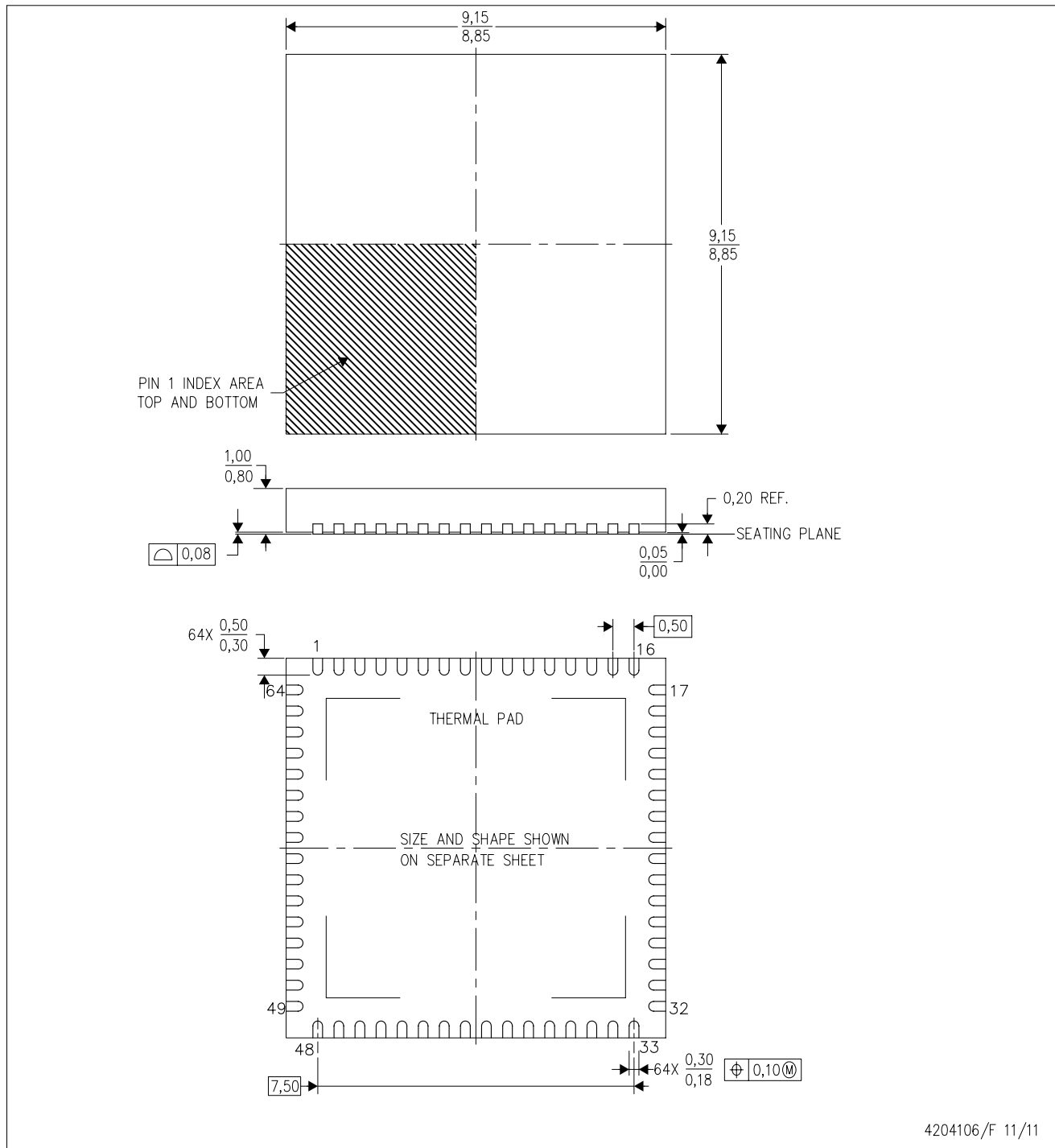

- NOTES:
- All linear dimensions are in millimeters. Dimensioning and tolerancing per ASME Y14.5-1994.
  - This drawing is subject to change without notice.
  - Quad Flatpack, No-leads (QFN) package configuration.
  - The package thermal pad must be soldered to the board for thermal and mechanical performance.
  - See the additional figure in the Product Data Sheet for details regarding the exposed thermal pad features and dimensions.

# THERMAL PAD MECHANICAL DATA

RGC (S-PVQFN-N64)

PLASTIC QUAD FLATPACK NO-LEAD

## THERMAL INFORMATION

This package incorporates an exposed thermal pad that is designed to be attached directly to an external heatsink. The thermal pad must be soldered directly to the printed circuit board (PCB). After soldering, the PCB can be used as a heatsink. In addition, through the use of thermal vias, the thermal pad can be attached directly to the appropriate copper plane shown in the electrical schematic for the device, or alternatively, can be attached to a special heatsink structure designed into the PCB. This design optimizes the heat transfer from the integrated circuit (IC).

For information on the Quad Flatpack No-Lead (QFN) package and its advantages, refer to Application Report, QFN/SON PCB Attachment, Texas Instruments Literature No. SLUA271. This document is available at [www.ti.com](http://www.ti.com).

The exposed thermal pad dimensions for this package are shown in the following illustration.

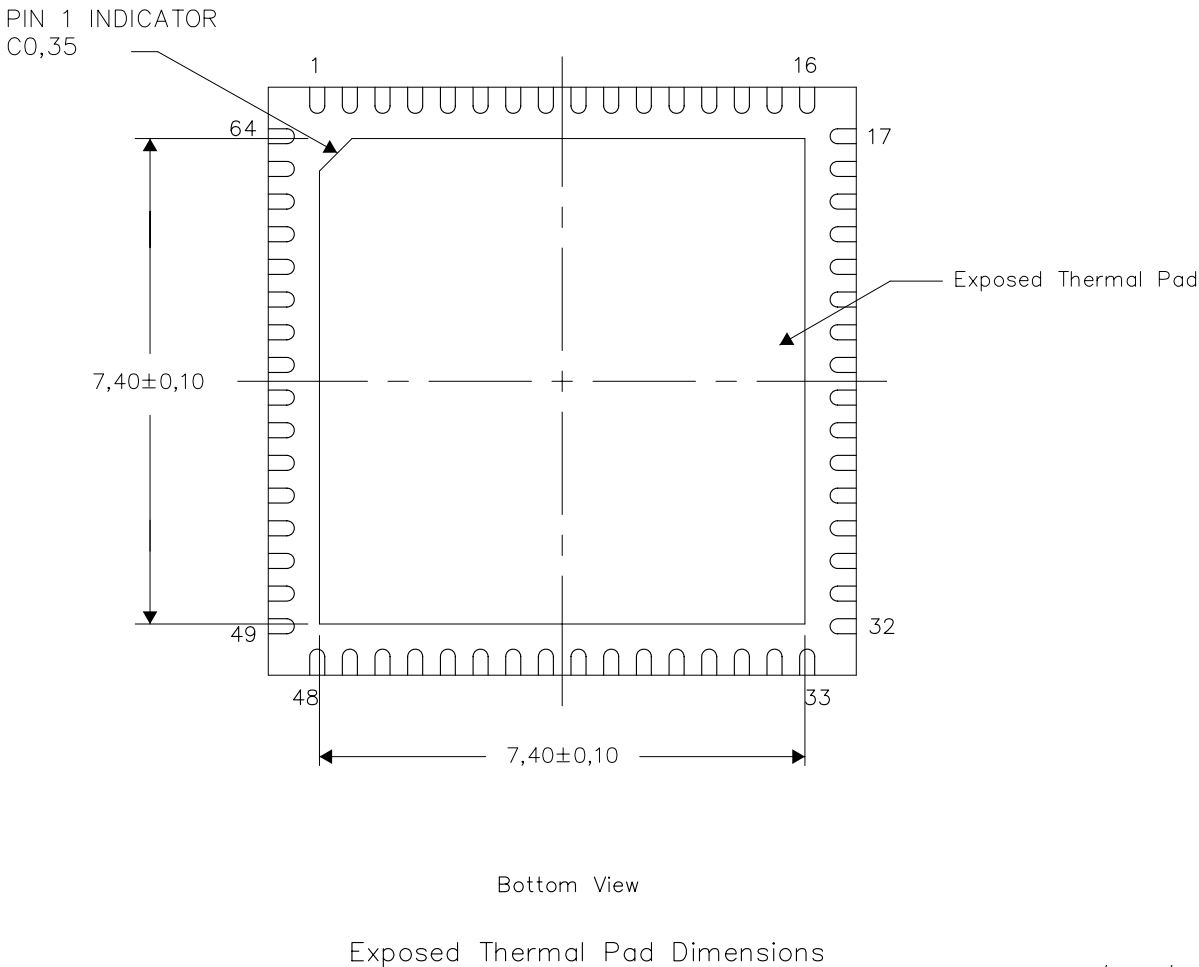

4206192-4/P 01/12

NOTE: A. All linear dimensions are in millimeters

RGC (S-PVQFN-N64)

PLASTIC QUAD FLATPACK NO-LEAD

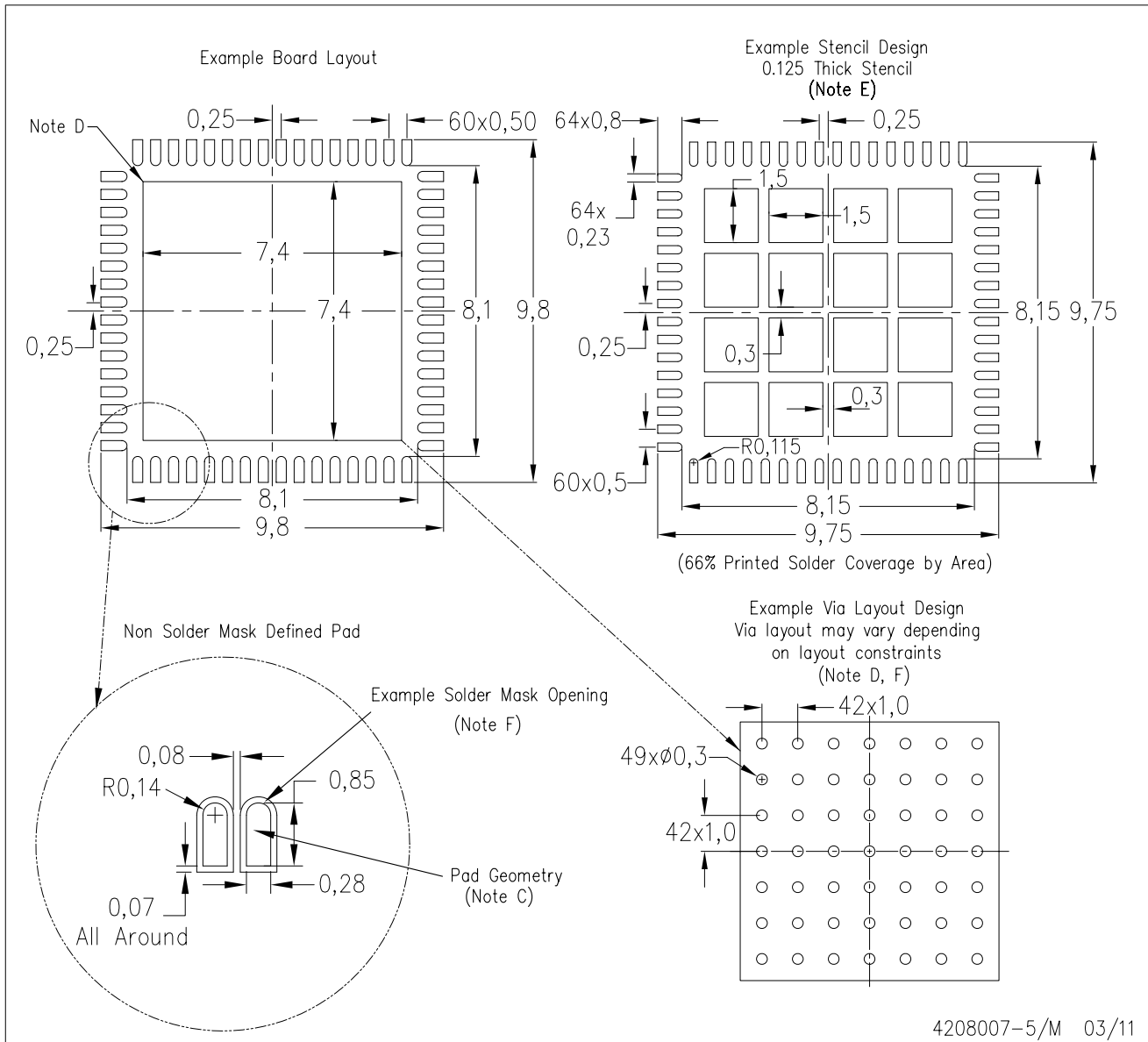

- NOTES:
- A. All linear dimensions are in millimeters.
  - B. This drawing is subject to change without notice.
  - C. Publication IPC-7351 is recommended for alternate designs.
  - D. This package is designed to be soldered to a thermal pad on the board. Refer to Application Note, Quad Flat-Pack Packages, Texas Instruments Literature No. SLUA271, and also the Product Data Sheets for specific thermal information, via requirements, and recommended board layout. These documents are available at [www.ti.com](http://www.ti.com) <<http://www.ti.com>>.
  - E. Laser cutting apertures with trapezoidal walls and also rounding corners will offer better paste release. Customers should contact their board assembly site for stencil design recommendations. Refer to IPC 7525 for stencil design considerations.
  - F. Customers should contact their board fabrication site for recommended solder mask tolerances and via tenting recommendations for vias placed in thermal pad.

## IMPORTANT NOTICE

Texas Instruments Incorporated and its subsidiaries (TI) reserve the right to make corrections, modifications, enhancements, improvements, and other changes to its products and services at any time and to discontinue any product or service without notice. Customers should obtain the latest relevant information before placing orders and should verify that such information is current and complete. All products are sold subject to TI's terms and conditions of sale supplied at the time of order acknowledgment.

TI warrants performance of its hardware products to the specifications applicable at the time of sale in accordance with TI's standard warranty. Testing and other quality control techniques are used to the extent TI deems necessary to support this warranty. Except where mandated by government requirements, testing of all parameters of each product is not necessarily performed.

TI assumes no liability for applications assistance or customer product design. Customers are responsible for their products and applications using TI components. To minimize the risks associated with customer products and applications, customers should provide adequate design and operating safeguards.

TI does not warrant or represent that any license, either express or implied, is granted under any TI patent right, copyright, mask work right, or other TI intellectual property right relating to any combination, machine, or process in which TI products or services are used. Information published by TI regarding third-party products or services does not constitute a license from TI to use such products or services or a warranty or endorsement thereof. Use of such information may require a license from a third party under the patents or other intellectual property of the third party, or a license from TI under the patents or other intellectual property of TI.

Reproduction of TI information in TI data books or data sheets is permissible only if reproduction is without alteration and is accompanied by all associated warranties, conditions, limitations, and notices. Reproduction of this information with alteration is an unfair and deceptive business practice. TI is not responsible or liable for such altered documentation. Information of third parties may be subject to additional restrictions.

Resale of TI products or services with statements different from or beyond the parameters stated by TI for that product or service voids all express and any implied warranties for the associated TI product or service and is an unfair and deceptive business practice. TI is not responsible or liable for any such statements.

TI products are not authorized for use in safety-critical applications (such as life support) where a failure of the TI product would reasonably be expected to cause severe personal injury or death, unless officers of the parties have executed an agreement specifically governing such use. Buyers represent that they have all necessary expertise in the safety and regulatory ramifications of their applications, and acknowledge and agree that they are solely responsible for all legal, regulatory and safety-related requirements concerning their products and any use of TI products in such safety-critical applications, notwithstanding any applications-related information or support that may be provided by TI. Further, Buyers must fully indemnify TI and its representatives against any damages arising out of the use of TI products in such safety-critical applications.

TI products are neither designed nor intended for use in military/aerospace applications or environments unless the TI products are specifically designated by TI as military-grade or "enhanced plastic." Only products designated by TI as military-grade meet military specifications. Buyers acknowledge and agree that any such use of TI products which TI has not designated as military-grade is solely at the Buyer's risk, and that they are solely responsible for compliance with all legal and regulatory requirements in connection with such use.

TI products are neither designed nor intended for use in automotive applications or environments unless the specific TI products are designated by TI as compliant with ISO/TS 16949 requirements. Buyers acknowledge and agree that, if they use any non-designated products in automotive applications, TI will not be responsible for any failure to meet such requirements.

Following are URLs where you can obtain information on other Texas Instruments products and application solutions:

### Products

Audio	<a href="http://www.ti.com/audio">www.ti.com/audio</a>
Amplifiers	<a href="http://amplifier.ti.com">amplifier.ti.com</a>
Data Converters	<a href="http://dataconverter.ti.com">dataconverter.ti.com</a>
DLP® Products	<a href="http://www.dlp.com">www.dlp.com</a>
DSP	<a href="http://dsp.ti.com">dsp.ti.com</a>
Clocks and Timers	<a href="http://www.ti.com/clocks">www.ti.com/clocks</a>
Interface	<a href="http://interface.ti.com">interface.ti.com</a>
Logic	<a href="http://logic.ti.com">logic.ti.com</a>
Power Mgmt	<a href="http://power.ti.com">power.ti.com</a>
Microcontrollers	<a href="http://microcontroller.ti.com">microcontroller.ti.com</a>
RFID	<a href="http://www.ti-rfid.com">www.ti-rfid.com</a>
OMAP Mobile Processors	<a href="http://www.ti.com/omap">www.ti.com/omap</a>
Wireless Connectivity	<a href="http://www.ti.com/wirelessconnectivity">www.ti.com/wirelessconnectivity</a>

### Applications

Automotive and Transportation	<a href="http://www.ti.com/automotive">www.ti.com/automotive</a>
Communications and Telecom	<a href="http://www.ti.com/communications">www.ti.com/communications</a>
Computers and Peripherals	<a href="http://www.ti.com/computers">www.ti.com/computers</a>
Consumer Electronics	<a href="http://www.ti.com/consumer-apps">www.ti.com/consumer-apps</a>
Energy and Lighting	<a href="http://www.ti.com/energy">www.ti.com/energy</a>
Industrial	<a href="http://www.ti.com/industrial">www.ti.com/industrial</a>
Medical	<a href="http://www.ti.com/medical">www.ti.com/medical</a>
Security	<a href="http://www.ti.com/security">www.ti.com/security</a>
Space, Avionics and Defense	<a href="http://www.ti.com/space-avionics-defense">www.ti.com/space-avionics-defense</a>
Video and Imaging	<a href="http://www.ti.com/video">www.ti.com/video</a>

TI E2E Community Home Page

[e2e.ti.com](http://e2e.ti.com)

Mailing Address: Texas Instruments, Post Office Box 655303, Dallas, Texas 75265  
Copyright © 2012, Texas Instruments Incorporated