

3V Video Amplifier with Internal Gain and Filter in SC70

Check for Samples: [OPA361-Q1](#)

FEATURES

- **Qualified for Automotive Applications**
- **Excellent Video Performance**
- **Internal Gain: 5.2V/V**
- **Supports TV-Detection**
- **Compatible with OMAP242x and DAVINCI™ Processors**
- **2-Pole Reconstruction Filter**
- **Input Range Includes Ground**
 - DC-Coupled Input
- **Integrated Level Shifter**
 - DC-Coupled Output⁽¹⁾
 - **No Output Capacitors Needed**
- **Rail-to-Rail Output**
- **Low Quiescent Current: 5.3mA**
- **Shutdown Current: 1.5μA**
- **Single-Supply: 2.5V to 3.3V**
- **SC70-6 Package: 2.0mm × 2.1mm**
- **RoHS Compliant**

⁽¹⁾ Internal circuitry avoids output saturation, even with 0V sync tip level at the input video signal.

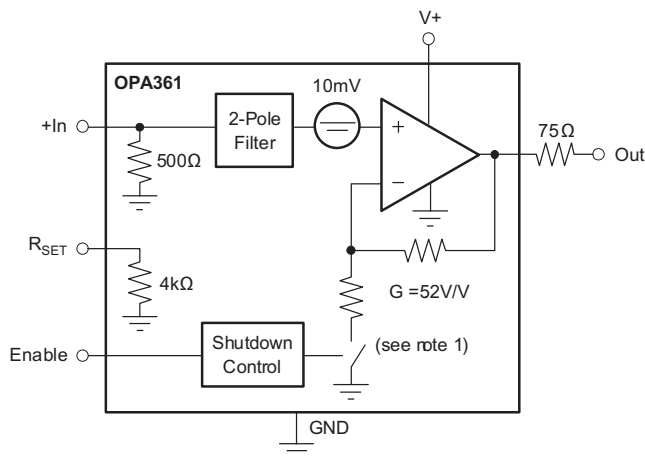

⁽¹⁾ Closed when enabled during normal operation; open when shut down.

DESCRIPTION

The OPA361-Q1 high-speed amplifier is optimized for 3V portable video applications. It is specifically designed to be compatible with the video encoders embedded in Texas Instruments' OMAP2420 and DaVinci processors or other application processors with 0.5V_{PP} video output. The input common-mode range includes GND, which allows a video-DAC (digital-to-analog converter) to be DC-coupled to the OPA361-Q1. The TV-detection feature simplifies the end-user interface significantly by facilitating the automatic start/stop of video transmission.

The output swings within 5mV of GND and 250mV to V+ with a standard back-terminated video load (150Ω). An internal level shift circuit prevents the output from saturating with 0V input, thus preventing sync-pulse clipping in common video circuits. Therefore, the OPA361-Q1 is ideally suited for DC-coupling to the video load.

The OPA361-Q1 has been optimized for space-sensitive applications by integrating internal gain setting resistors ($G = 5.2V/V$) and a 2-pole video-DAC reconstruction filter.

In shutdown mode, the quiescent current is reduced to < 1.5μA, dramatically reducing power consumption and prolonging battery life.

The OPA361-Q1 is available in the tiny 2mm × 2.1mm SC70-6 package.



Please be aware that an important notice concerning availability, standard warranty, and use in critical applications of Texas Instruments semiconductor products and disclaimers thereto appears at the end of this data sheet.

OPA361-Q1

SBOS552 – MARCH 2011

www.ti.com



These devices have limited built-in ESD protection. The leads should be shorted together or the device placed in conductive foam during storage or handling to prevent electrostatic damage to the MOS gates.

ORDERING INFORMATION⁽¹⁾

PRODUCT	PACKAGE	PACKAGE DESIGNATOR	PACKAGE MARKING
OPA361-Q1	SC70-6	DCK	QXP

- (1) For the most current package and ordering information, see the Package Option Addendum at the end of this datasheet, or see the TI website at www.ti.com.

PIN CONFIGURATION

DCK PACKAGE
(TOP VIEW)

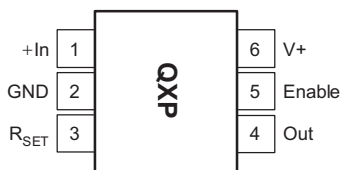

The location of pin 1 on the OPA361-Q1 is determined by orienting the package marking as shown in the diagram above.

ABSOLUTE MAXIMUM RATINGS⁽¹⁾

	VALUE	UNIT
Supply voltage, V+ to V-	+3.6	V
Signal input terminals	Voltage ⁽²⁾	-0.5 to (V+) + 0.5
	Current ⁽²⁾	±10
Output short-circuit through 75Ω to GND ⁽³⁾	Continuous	
Operating temperature	-40 to +125	°C
Storage temperature	-65 to +150	°C
Junction temperature	+160	°C

- (1) Stresses above these ratings may cause permanent damage. Exposure to absolute maximum conditions for extended periods may degrade device reliability. These are stress ratings only, and functional operation of the device at these or any other conditions beyond those specified is not implied.
- (2) Input terminals are diode-clamped to the power-supply rails. Input signals that can swing more than 0.5V beyond the supply rails should be current-limited to 10mA or less.
- (3) Short-circuit to ground.

ELECTRICAL CHARACTERISTICS: $V_S = +2.5V$ to $+3.3V$
Boldface limits apply over the temperature range, $T_A = -40^{\circ}C$ to $+125^{\circ}C$.

At $T_A = +25^{\circ}C$, $R_L = 150\Omega$ connected to GND, unless otherwise noted.

PARAMETER		TEST CONDITIONS	MIN	TYP	MAX	UNIT
OFFSET LEVEL-SHIFT VOLTAGE						
V_{OLS}	Output Level-Shift Voltage ⁽¹⁾	$V_S = +2.8V$, $V_{IN} = GND$	-3	11	55	mV
Over Temperature				20		mV
PSRR	vs Power Supply	$V_S = +2.5V$ to $+3.3V$		± 80		$\mu V/V$
INPUT VOLTAGE RANGE						
V_{CM}	Input Voltage Range ⁽²⁾	$V_S = 2.5V$	GND		0.42	V
		$V_S = 2.8V$	GND		0.48	V
		$V_S = 3.3V$	GND		0.55	V
R_{IN}	Input Resistance (+In)		450	510	550	Ω
R_{SET}	R_{SET} Resistance		3600	4070	4400	Ω
Matching of R_{IN} and R_{SET}			2%	0.5%		
VOLTAGE GAIN						
		$\Delta V_{OUT}/\Delta V_{IN}$, $V_S = +2.5V$, $V_{INMIN} = 0V$, $V_{INMAX} = 0.42V$	5.06	5.17	5.28	V/V
		$\Delta V_{OUT}/\Delta V_{IN}$, $V_S = +2.8V$, $V_{INMIN} = 0V$, $V_{INMAX} = 0.48V$	5.06	5.17	5.28	V/V
		$\Delta V_{OUT}/\Delta V_{IN}$, $V_S = +3.3V$, $V_{INMIN} = 0V$, $V_{INMAX} = 0.55V$	5.06	5.17	5.28	V/V
FREQUENCY RESPONSE						
Filter Response						
f-3dB	Cutoff Frequency			9		MHz
Normalized Gain:	$f_{IN} = 4.5MHz$	$V_O = 2V_{PP}$		-0.1		dB
	$f_{IN} = 27MHz$	$V_O = 2V_{PP}$		-18		dB
	$f_{IN} = 54MHz$	$V_O = 2V_{PP}$		-23		dB
Differential Gain Error		$R_L = 150\Omega$		1.2%		
Differential Phase Error		$R_L = 150\Omega$		1.6		degrees
Group Delay Variation		100kHz, 4.5MHz		26		ns
SNR	Signal-to-Noise Ratio	100% White Signal		65		dB
OUTPUT						
Positive Voltage Output Swing from Rail		$V_S = +2.8V$, $V_{IN} = 0.7V$, Ω to GND		130	250	mV
Negative Voltage Output Swing from Rail		$V_S = +2.8V$, $V_{IN} = -0.05V$, $R_L = 150\Omega$ to GND		0.15	5	mV
Positive Voltage Output Swing from Rail		$V_S = +2.8V$, $V_{IN} = 0.7V$, $R_L = 75\Omega$ to GND		260		mV
Negative Voltage Output Swing from Rail		$V_S = +2.8V$, $V_{IN} = -0.05V$, $R_L = 75\Omega$ to GND		2		mV
Output Leakage		$V_S = +2.8V$, Disabled, $V_O = 2V$		0.3	100	nA
I_O	Output Current ⁽³⁾	$V_S = +2.8V$		± 80		mA
POWER SUPPLY						
V_S	Specified Voltage Range		2.5		3.3	V
I_Q	Quiescent Current	$V_S = +2.8V$, Enabled, $I_O = 0$, $V_{OUT} = 1.4V$		5.3	7.5	mA
Over Temperature		Specified Temperature Range			9	mA
ENABLE/SHUTDOWN FUNCTION						
Disabled (logic-LOW threshold)			0		0.35	V
Enabled (logic-HIGH threshold)			1.3		V_S	V
Enable Time				1.5		μs
Disable Time				50		ns
Shutdown Current		$V_S = +2.8V$, Disabled		1.5	3	μA
TEMPERATURE RANGE						
Specified/Operating Range			-40		+125	$^{\circ}C$
Storage Range			-65		+150	$^{\circ}C$
θ_{JA}	Thermal Resistance			250		$^{\circ}C/W$
SC70						

(1) Output referred.

(2) Limited by output swing and internal $G = 5.2V/V$.

(3) See typical characteristics *Output Voltage Swing vs Output Current*.

TYPICAL CHARACTERISTICS: $V_S = 2.8\text{ V}$

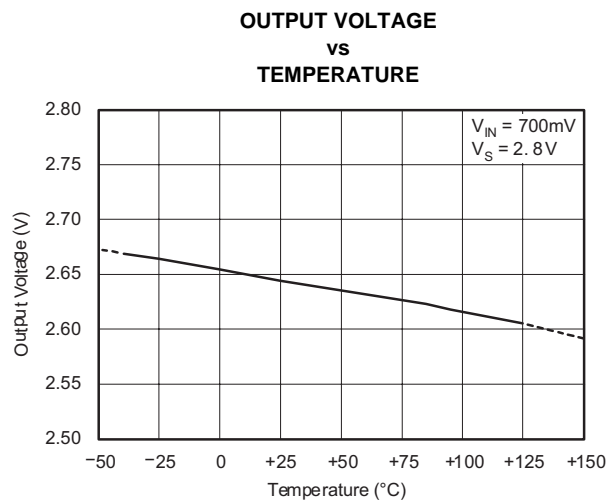
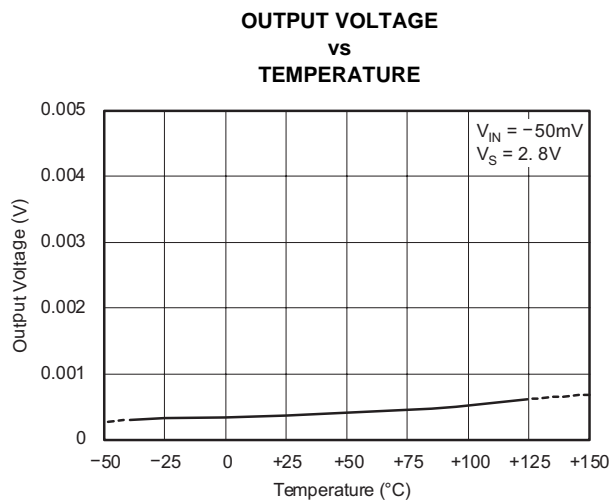
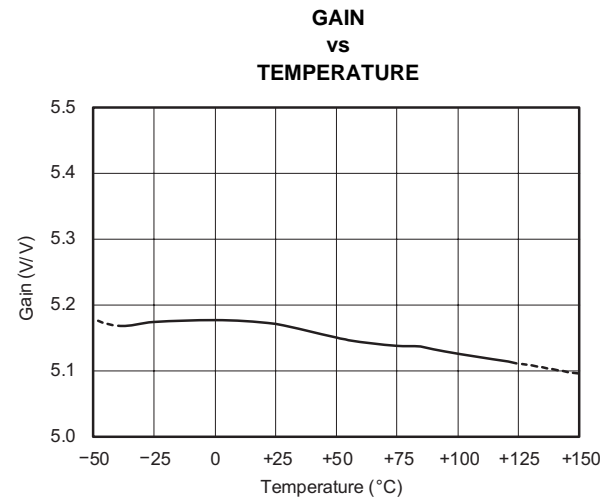
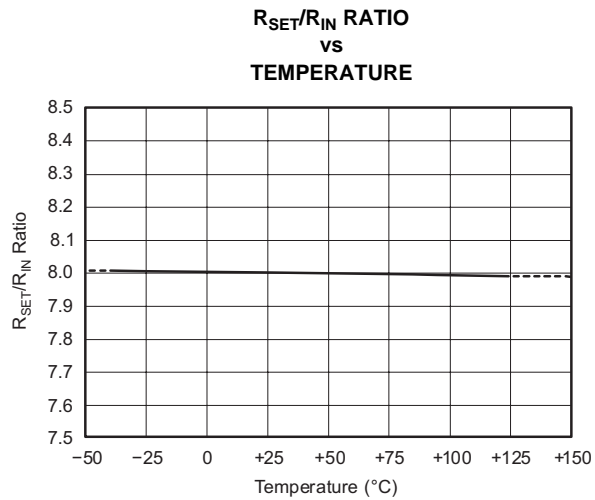
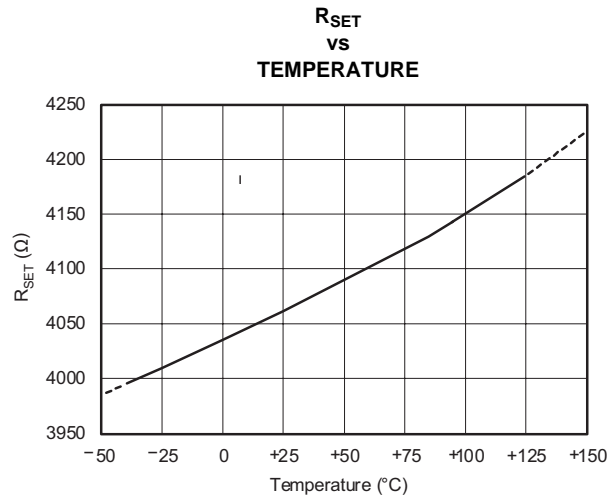
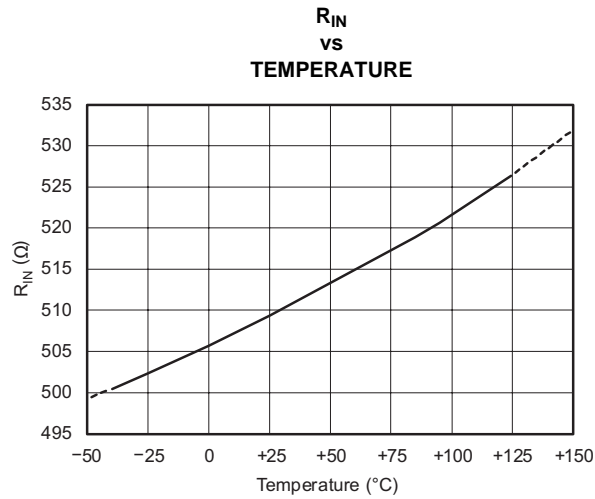
 At $T_A = +25^\circ\text{C}$ and $R_L = 150$, unless otherwise noted.

TYPICAL CHARACTERISTICS: $V_S = 2.8\text{ V}$ (continued)

At $T_A = +25^\circ\text{C}$ and $R_L = 150$, unless otherwise noted.

**V_{OUT} LEVEL SHIFT
vs
TEMPERATURE**

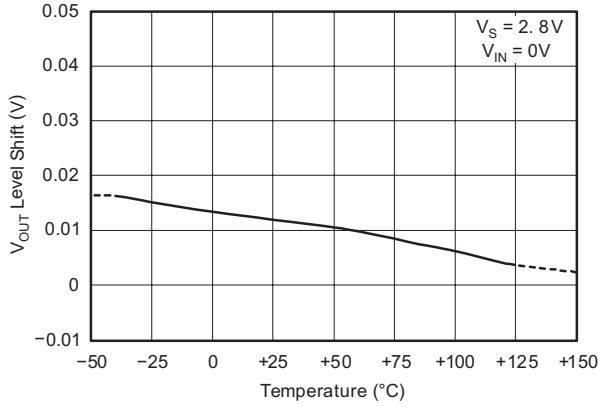

**QUIESCENT CURRENT
vs
TEMPERATURE**

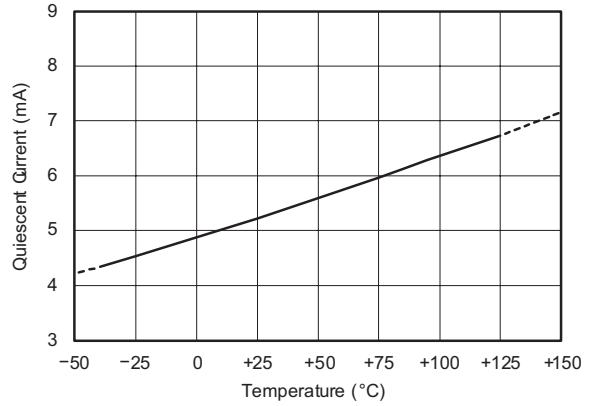

**OUTPUT LEAKAGE CURRENT
vs
TEMPERATURE**

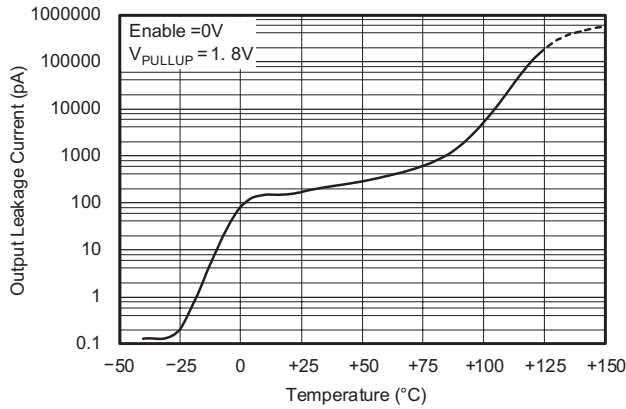

**OUTPUT LEAKAGE
vs
IN SHUTDOWN**

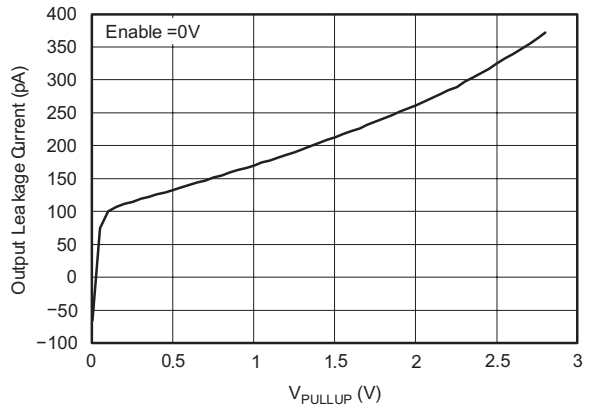

**SHUTDOWN QUIESCENT CURRENT HYSTERESIS
vs
TEMPERATURE**

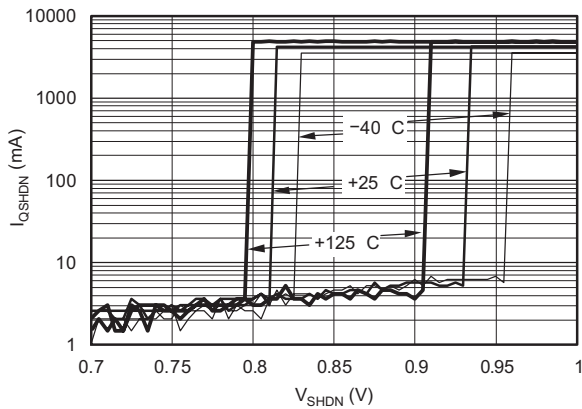

**AC RESPONSE
vs
AT VARIOUS TEMPERATURES**

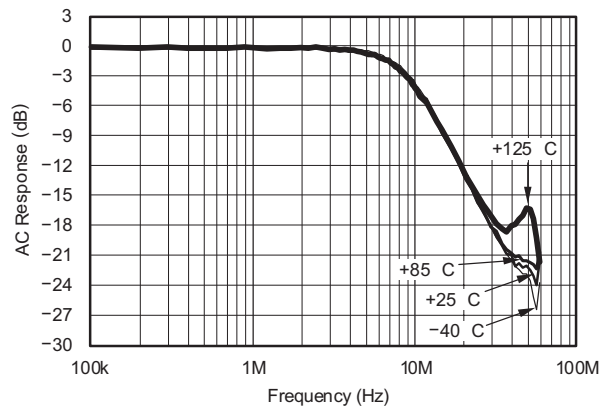

OPA361-Q1

SBOS552 – MARCH 2011

www.ti.com

TYPICAL CHARACTERISTICS: $V_S = 2.8\text{ V}$ (continued)

At $T_A = +25^\circ\text{C}$ and $R_L = 150$, unless otherwise noted.

TURN-ON TIME

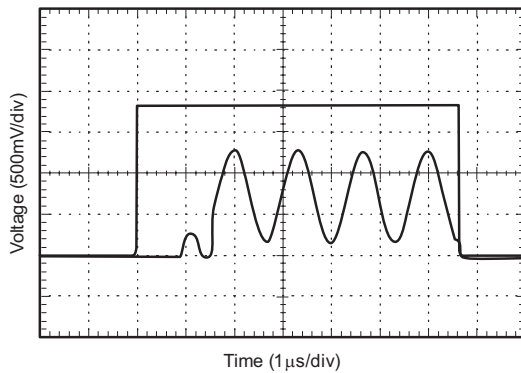

TURN-OFF TIME

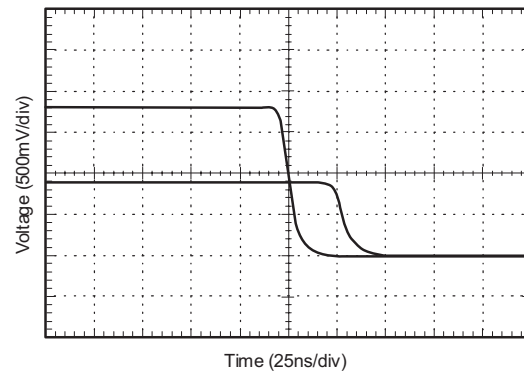

**OUTPUT VOLTAGE
vs
OUTPUT CURRENT**

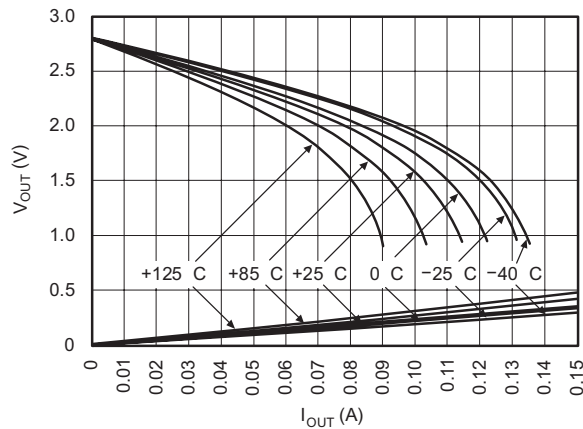

**GROUP DELAY
vs
FREQUENCY**

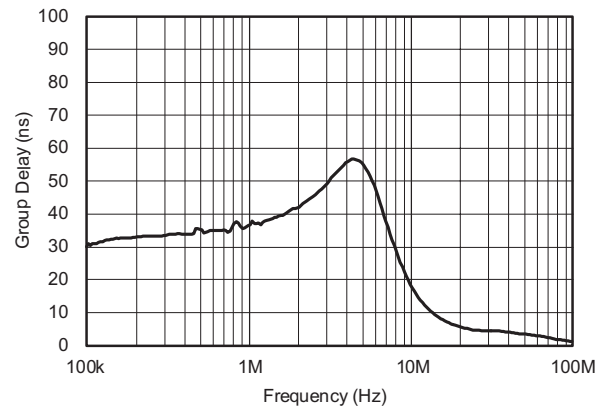

DIFFERENTIAL GAIN

INP = A - C		SYNC = INT	MTIME = 10s	LINE = 330
DG1	-0.6 %1	-5	0	+5
DG2	-1.0 %			
DG3	-1.1 %			
DG4	-1.2 %			
DG5	-0.8 %5			
STEPS		ZOOM		MODE
4 5		0 1 2		1

DIFFERENTIAL PHASE

IN P = A - C		SYNC = INT	MTIME = 10s	LINE = 330
DP1	1.1 dg1	-5	0	+5
DP2	1.6 dg			
DP3	1.6 dg			
DP4	1.5 dg			
DP5	1.1 dg5			
STEPS		ZOOM		MODE
4 5		0 1 2		1

APPLICATION INFORMATION

The OPA361-Q1 video amplifier has been optimized to fit seamlessly with Texas Instruments' OMAP242x Multimedia processor. The following features have been integrated to provide excellent video performance.

- Internal gain setting resistors ($G = 5.2V/V$) reduce the number of external components needed in the video circuit.
- Integration of the 500Ω video encoder load resistor and $4k\Omega$ RSET resistor used by the OMAP242x helps minimize the number of external components and also ensures excellent ratio and temperature tracking. This feature helps to keep the overall gain accurate and stable over temperature.
- TV-detection support in connection with an OMAP242x multimedia processor. This feature helps to automate start/stop operation of the TV-out function and minimizes power consumption.
- A 2-pole filter is incorporated for DAC signal reconstruction.
- The OPA361-Q1 employs an internal level shift circuit that avoids sync pulse clipping and allows DC-coupled output.
- A shutdown feature reduces quiescent current to less than $1.5\mu A$ —crucial for portable applications

Although OPA361-Q1 is optimized for the OMAP242x processor, it is also suitable to interface with any digital media processor that outputs a video signal on the order of $0.4V_{PP}$ to $0.5V_{PP}$.

Figure 1 shows a typical application drawing with the OMAP242x processor and the TWL92230 Energy Management Chip.

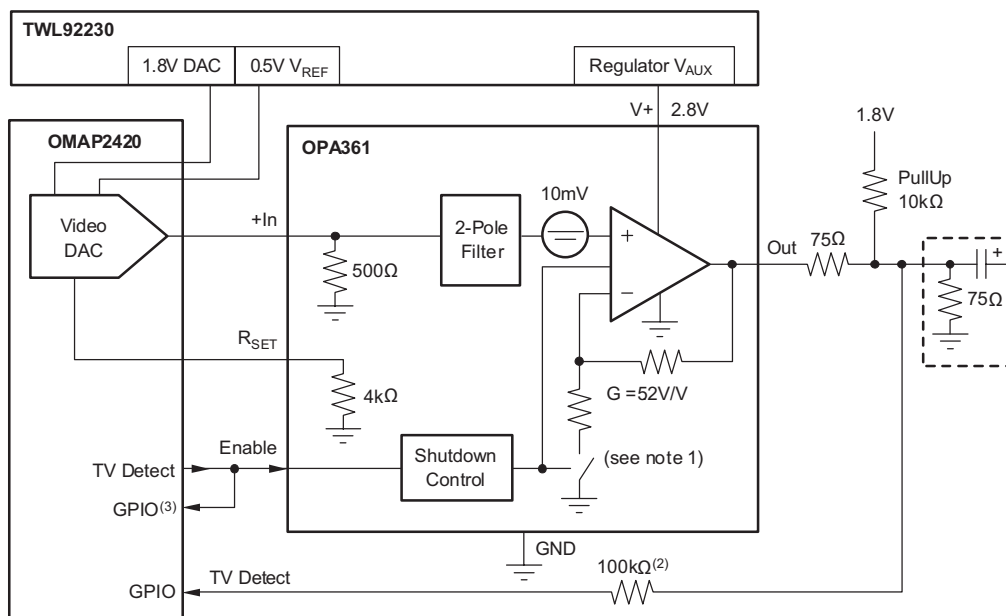

Figure 1. Typical Application using the OMAP242x and the TWL92230

OPERATING VOLTAGE

The OPA361-Q1 is fully specified from 2.5V to 3.3V over a temperature range of -40°C to $+125^{\circ}\text{C}$. Parameters that vary significantly with operating voltages or temperature are shown in the Typical Characteristics. Power-supply pins should be bypassed with 100nF ceramic capacitors.

INPUT VOLTAGE

The input common-mode range of the OPA361-Q1 series extends from GND to 0.55V on a 3.3V supply. The input range is limited by the internal gain in conjunction with the maximum output swing capability and the power-supply voltage.

INPUT OVERVOLTAGE PROTECTION

All OPA361-Q1 pins are static-protected with internal ESD protection diodes connected to the supplies. These diodes will provide input overdrive protection if the current is externally limited to 10mA.

ENABLE/SHUTDOWN

The OPA361-Q1 has a shutdown feature that disables the output and reduces the quiescent current to less than $1.5\mu\text{A}$. This feature is especially useful for portable video applications, where the device is infrequently connected to a television (TV) or other video device.

The Enable logic input voltage is referenced to the OPA361-Q1 GND pin. A logic level HIGH applied to the enable pin enables the op amp. The logic levels are compatible with 1.8V CMOS logic levels. A valid logic HIGH is defined as $> 1.3\text{V}$ above GND. A valid logic LOW is defined as $< 0.35\text{V}$ above GND. If the Enable pin is not connected, internal pull-up circuitry will enable the amplifier.

When disabling the OPA361-Q1, internal circuitry also disconnects the internal gain setting feedback. This feature is in support of the TV-detection function. See the *TV-Detect Function* section for more detailed information.

INTERNAL 2-POLE FILTER

The OPA361-Q1 filter is a Sallen-Key topology with a 9MHz cutoff frequency. [Figure 2](#) shows a detailed drawing of the filter components. This filter allows video signals to pass without any visible distortion, as shown in [Figure 3](#) through [Figure 6](#). The video encoder embedded in the OMAP242x processor typically samples at 54MHz. At this frequency, the attenuation is typically 23dB, which effectively attenuates the sampling aliases.

The internal 500Ω resistor on the input to GND converts the output current of the OMAP2420 internal video DAC into a voltage. It is also part of the Sallen-Key filter. Using an external resistor to adjust the input voltage range will also alter the filter characteristics.

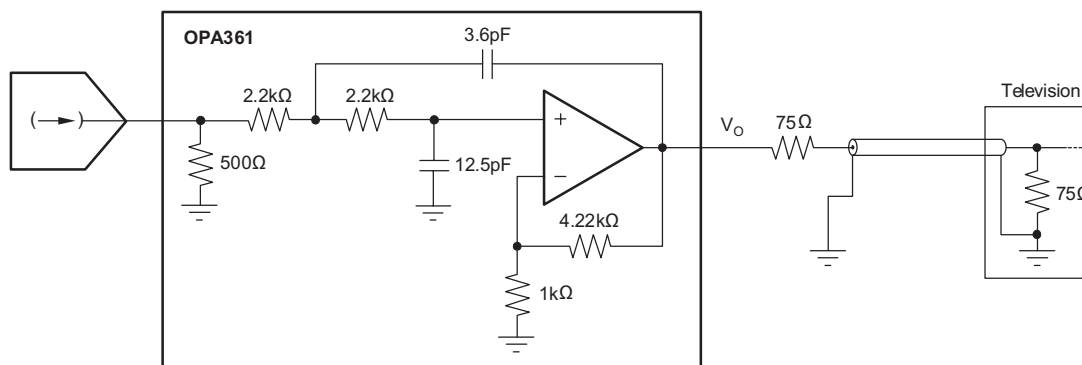

Figure 2. Filter Structure of the OPA361-Q1

Video Performance

The color bar signal in [Figure 3](#) shows excellent amplitude characteristics and no attenuation of colors with respect to the luminance signal.

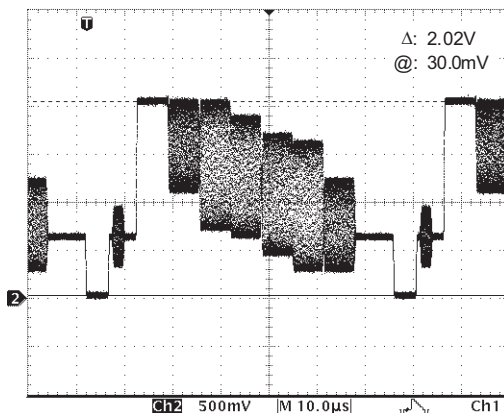

Figure 3. 100/75 Color Bar Signal at Output of OPA361-Q1

The CCIR330/5 test pattern requires one of the greatest dynamic ranges, and therefore tests the OPA361-Q1 output voltage swing capability. The scope plot shown in [Figure 4](#) has been taken with a 2.8V supply and shows no clipping on the top side of the signal.

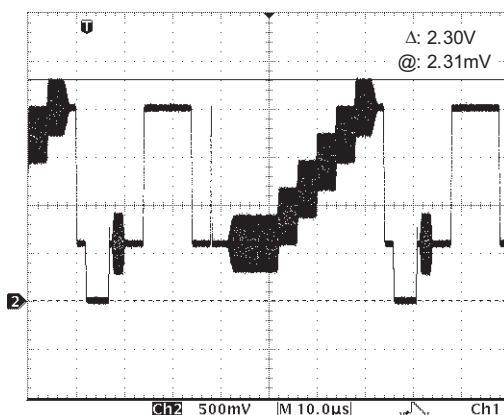

Figure 4. CCIR330/5: No Clipping, Even On 2.8V Supply

The multiburst test patterns have different sine-wave burst sections with the following frequencies: 0.5MHz, 1MHz, 2MHz, 4MHz, 4.8MHz and 5.8MHz with 420mVPP. There is no visible attenuation even at the highest frequencies, which indicates a very flat frequency response of the OPA361-Q1. As shown in [Figure 5](#) and [Figure 6](#), the top line illustrates the full signal and the bottom line is a more detailed view of the last three sine wave bursts.

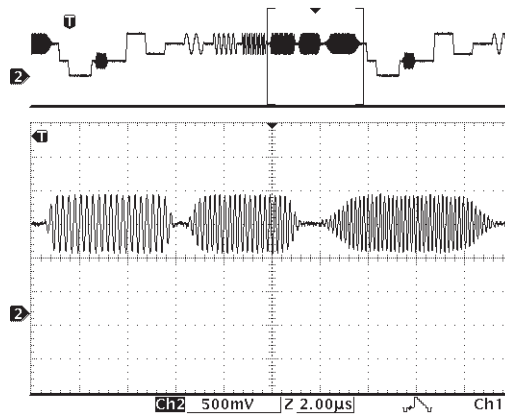

Figure 5. Multiburst Signal (CCIR 18/1) Shows Very Flat Frequency Response

The CCIR17 test pattern contains a 2T and a 20T pulse, as shown in [Figure 6](#). The 2T pulse is used to check for pulse distortion and reflection, and the 20T pulse is used to check for amplitude and group delay between chrominance and luminance. Neither pulse exhibits any distortion or group delay artifacts.

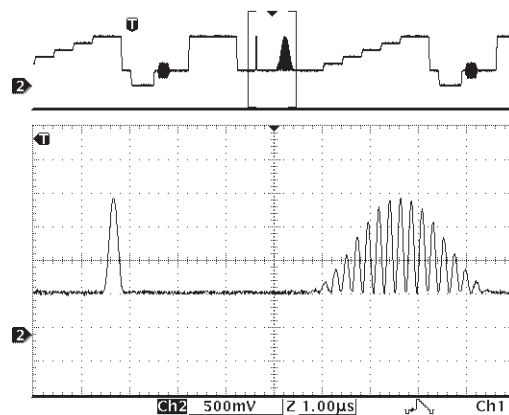

Figure 6. CCIR 17 2T and 20T Pulses Show No Visible Distortion

INTERNAL LEVEL SHIFT

Many common video DACs embedded in digital media processors, like the new OMAP242x processors, operate on a single supply (no negative supply). Typically, the lowest point of the sync pulse output by these video DACs is close to 0V. With a 0V input, the output of a common single-supply op amp saturates at a voltage > 0V. This effect would clip the sync pulse, and therefore degrade the video signal integrity. The OPA361-Q1 employs an internal level shift circuit to avoid clipping. The input signal is typically shifted by approximately 11mV. This shift is well within the linear output voltage range of the OPA361-Q1 with a standard 150Ω video load.

Output Swing Capability

[Figure 7](#) shows the true output swing capability of the OPA361-Q1 by taking the tip of the input sync pulse to a slightly negative voltage. Even when the output sync tip is at 3mV, the output after the 75Ω series termination still shows no clipping of the sync pulse.

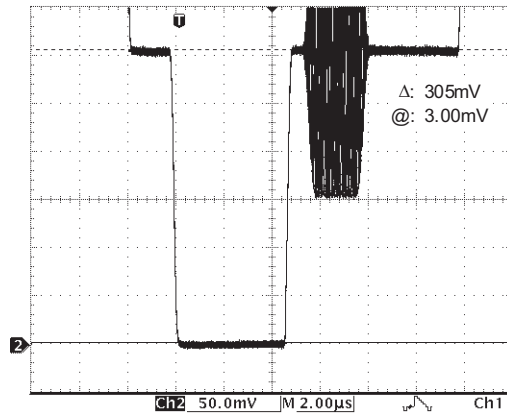

Figure 7. No Clipping of the Sync Pulse

TV-Detect Function

The TV-detection feature of the OPA361-Q1 works in conjunction with the OMAP242x (or other processors) to detect if a television is connected to the video output of the device. In order to detect a TV load, the OPA361-Q1 is briefly turned off, ideally during the first vertical sync pulse. For the detection, a simple pull-up resistor to the processor logic supply is used on the output of the OPA361-Q1. The voltage level is pulled LOW if the TV (or other video equipment) is connected, or HIGH if nothing is connected. A GPIO in the processor can be used to read this logic level and decide if a video load is connected. Figure 8 shows a scope plot with the TV disconnected and Figure 9 shows a scope plot with the TV connected; the upper line in both figures is the disable pulse. Figure 10 shows a circuit drawing using the TV-detect signal to disable or enable the OPA361-Q1.

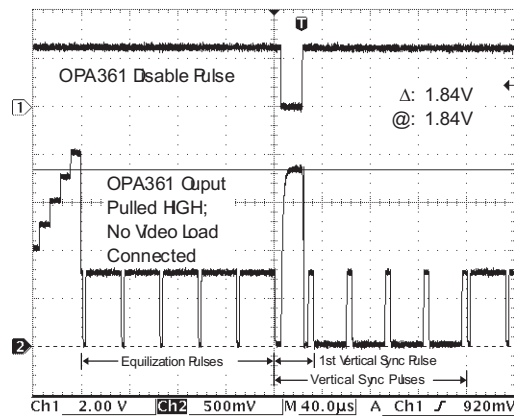

Figure 8. Output of OPA361-Q1 Pulled Up To 1.8V During Disable: TV Disconnected

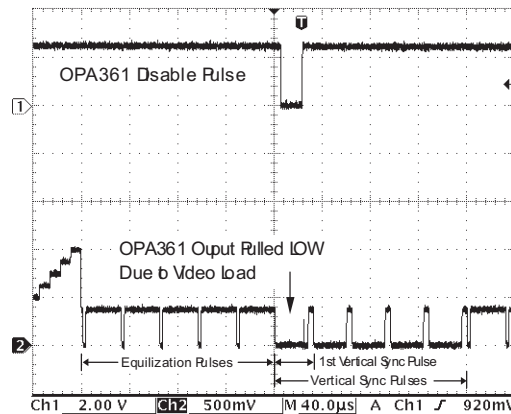

Figure 9. Output of OPA361-Q1 Pulled Down: TV Connected.

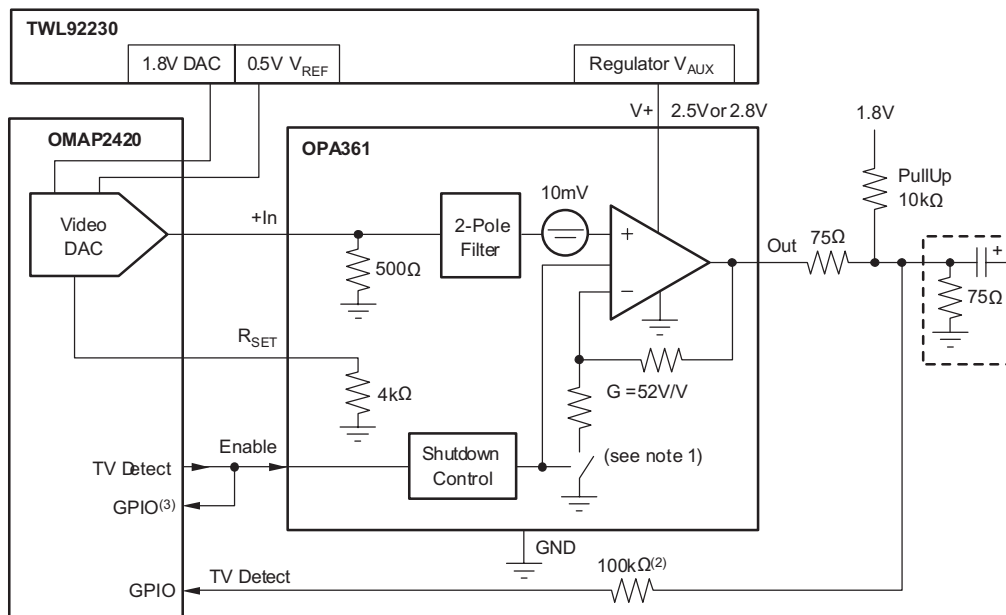

Figure 10. Using TV-Detect Signal to Disable/Enable the OPA361-Q1

Disabling the OPA361-Q1 also disconnects the internal feedback resistors' path to GND, and therefore there is no current flowing from the logic supply through the pull-up resistor to GND if no video load is connected; this helps to conserve battery life. The typical leakage when the output is pulled high and OPA361-Q1 is disabled is only about 300pA.

The following functionality can be achieved by implementing TV-detection:

- Automatic video start by polling the video line periodically.
- Automatic video stop if the TV (or other equipment) is disconnected.

Proper implementation allows to significantly simplify the user interface.

For more information, see Application Report SBOA109, *OPA361-Q1 and TV Detection*, available for download at www.ti.com.

PACKAGING INFORMATION

Orderable Device	Status ⁽¹⁾	Package Type	Package Drawing	Pins	Package Qty	Eco Plan ⁽²⁾	Lead/ Ball Finish	MSL Peak Temp ⁽³⁾	Samples (Requires Login)
OPA361AQDCKRQ1	ACTIVE	SC70	DCK	6	3000	Green (RoHS & no Sb/Br)	CU NIPDAU	Level-2-260C-1 YEAR	

⁽¹⁾ The marketing status values are defined as follows:

ACTIVE: Product device recommended for new designs.

LIFEBUY: TI has announced that the device will be discontinued, and a lifetime-buy period is in effect.

NRND: Not recommended for new designs. Device is in production to support existing customers, but TI does not recommend using this part in a new design.

PREVIEW: Device has been announced but is not in production. Samples may or may not be available.

OBSOLETE: TI has discontinued the production of the device.

⁽²⁾ Eco Plan - The planned eco-friendly classification: Pb-Free (RoHS), Pb-Free (RoHS Exempt), or Green (RoHS & no Sb/Br) - please check <http://www.ti.com/productcontent> for the latest availability information and additional product content details.

TBD: The Pb-Free/Green conversion plan has not been defined.

Pb-Free (RoHS): TI's terms "Lead-Free" or "Pb-Free" mean semiconductor products that are compatible with the current RoHS requirements for all 6 substances, including the requirement that lead not exceed 0.1% by weight in homogeneous materials. Where designed to be soldered at high temperatures, TI Pb-Free products are suitable for use in specified lead-free processes.

Pb-Free (RoHS Exempt): This component has a RoHS exemption for either 1) lead-based flip-chip solder bumps used between the die and package, or 2) lead-based die adhesive used between the die and leadframe. The component is otherwise considered Pb-Free (RoHS compatible) as defined above.

Green (RoHS & no Sb/Br): TI defines "Green" to mean Pb-Free (RoHS compatible), and free of Bromine (Br) and Antimony (Sb) based flame retardants (Br or Sb do not exceed 0.1% by weight in homogeneous material)

⁽³⁾ MSL, Peak Temp. -- The Moisture Sensitivity Level rating according to the JEDEC industry standard classifications, and peak solder temperature.

Important Information and Disclaimer: The information provided on this page represents TI's knowledge and belief as of the date that it is provided. TI bases its knowledge and belief on information provided by third parties, and makes no representation or warranty as to the accuracy of such information. Efforts are underway to better integrate information from third parties. TI has taken and continues to take reasonable steps to provide representative and accurate information but may not have conducted destructive testing or chemical analysis on incoming materials and chemicals. TI and TI suppliers consider certain information to be proprietary, and thus CAS numbers and other limited information may not be available for release.

In no event shall TI's liability arising out of such information exceed the total purchase price of the TI part(s) at issue in this document sold by TI to Customer on an annual basis.

OTHER QUALIFIED VERSIONS OF OPA361-Q1 :

- Catalog: [OPA361](#)

NOTE: Qualified Version Definitions:

- Catalog - TI's standard catalog product

TAPE AND REEL INFORMATION

QUADRANT ASSIGNMENTS FOR PIN 1 ORIENTATION IN TAPE

*All dimensions are nominal

Device	Package Type	Package Drawing	Pins	SPQ	Reel Diameter (mm)	Reel Width W1 (mm)	A0 (mm)	B0 (mm)	K0 (mm)	P1 (mm)	W (mm)	Pin1 Quadrant
OPA361AQDCKRQ1	SC70	DCK	6	3000	179.0	8.4	2.2	2.5	1.2	4.0	8.0	Q3

TAPE AND REEL BOX DIMENSIONS



*All dimensions are nominal

Device	Package Type	Package Drawing	Pins	SPQ	Length (mm)	Width (mm)	Height (mm)
OPA361AQDCKRQ1	SC70	DCK	6	3000	195.0	200.0	45.0

DCK (R-PDSO-G6)

PLASTIC SMALL-OUTLINE PACKAGE



- NOTES:
- A. All linear dimensions are in millimeters.
 - B. This drawing is subject to change without notice.
 - C. Body dimensions do not include mold flash or protrusion. Mold flash and protrusion shall not exceed 0.15 per side.
 - D. Falls within JEDEC MO-203 variation AB.

DCK (R-PDSO-G6)

PLASTIC SMALL OUTLINE



- NOTES:
- All linear dimensions are in millimeters.
 - This drawing is subject to change without notice.
 - Customers should place a note on the circuit board fabrication drawing not to alter the center solder mask defined pad.
 - Publication IPC-7351 is recommended for alternate designs.
 - Laser cutting apertures with trapezoidal walls and also rounding corners will offer better paste release. Customers should contact their board assembly site for stencil design recommendations. Example stencil design based on a 50% volumetric metal load solder paste. Refer to IPC-7525 for other stencil recommendations.

IMPORTANT NOTICE

Texas Instruments Incorporated and its subsidiaries (TI) reserve the right to make corrections, modifications, enhancements, improvements, and other changes to its products and services at any time and to discontinue any product or service without notice. Customers should obtain the latest relevant information before placing orders and should verify that such information is current and complete. All products are sold subject to TI's terms and conditions of sale supplied at the time of order acknowledgment.

TI warrants performance of its hardware products to the specifications applicable at the time of sale in accordance with TI's standard warranty. Testing and other quality control techniques are used to the extent TI deems necessary to support this warranty. Except where mandated by government requirements, testing of all parameters of each product is not necessarily performed.

TI assumes no liability for applications assistance or customer product design. Customers are responsible for their products and applications using TI components. To minimize the risks associated with customer products and applications, customers should provide adequate design and operating safeguards.

TI does not warrant or represent that any license, either express or implied, is granted under any TI patent right, copyright, mask work right, or other TI intellectual property right relating to any combination, machine, or process in which TI products or services are used. Information published by TI regarding third-party products or services does not constitute a license from TI to use such products or services or a warranty or endorsement thereof. Use of such information may require a license from a third party under the patents or other intellectual property of the third party, or a license from TI under the patents or other intellectual property of TI.

Reproduction of TI information in TI data books or data sheets is permissible only if reproduction is without alteration and is accompanied by all associated warranties, conditions, limitations, and notices. Reproduction of this information with alteration is an unfair and deceptive business practice. TI is not responsible or liable for such altered documentation. Information of third parties may be subject to additional restrictions.

Resale of TI products or services with statements different from or beyond the parameters stated by TI for that product or service voids all express and any implied warranties for the associated TI product or service and is an unfair and deceptive business practice. TI is not responsible or liable for any such statements.

TI products are not authorized for use in safety-critical applications (such as life support) where a failure of the TI product would reasonably be expected to cause severe personal injury or death, unless officers of the parties have executed an agreement specifically governing such use. Buyers represent that they have all necessary expertise in the safety and regulatory ramifications of their applications, and acknowledge and agree that they are solely responsible for all legal, regulatory and safety-related requirements concerning their products and any use of TI products in such safety-critical applications, notwithstanding any applications-related information or support that may be provided by TI. Further, Buyers must fully indemnify TI and its representatives against any damages arising out of the use of TI products in such safety-critical applications.

TI products are neither designed nor intended for use in military/aerospace applications or environments unless the TI products are specifically designated by TI as military-grade or "enhanced plastic." Only products designated by TI as military-grade meet military specifications. Buyers acknowledge and agree that any such use of TI products which TI has not designated as military-grade is solely at the Buyer's risk, and that they are solely responsible for compliance with all legal and regulatory requirements in connection with such use.

TI products are neither designed nor intended for use in automotive applications or environments unless the specific TI products are designated by TI as compliant with ISO/TS 16949 requirements. Buyers acknowledge and agree that, if they use any non-designated products in automotive applications, TI will not be responsible for any failure to meet such requirements.

Following are URLs where you can obtain information on other Texas Instruments products and application solutions:

Products

Audio	www.ti.com/audio
Amplifiers	amplifier.ti.com
Data Converters	dataconverter.ti.com
DLP® Products	www.dlp.com
DSP	dsp.ti.com
Clocks and Timers	www.ti.com/clocks
Interface	interface.ti.com
Logic	logic.ti.com
Power Mgmt	power.ti.com
Microcontrollers	microcontroller.ti.com
RFID	www.ti-rfid.com
RF/IF and ZigBee® Solutions	www.ti.com/lprf

Applications

Communications and Telecom	www.ti.com/communications
Computers and Peripherals	www.ti.com/computers
Consumer Electronics	www.ti.com/consumer-apps
Energy and Lighting	www.ti.com/energy
Industrial	www.ti.com/industrial
Medical	www.ti.com/medical
Security	www.ti.com/security
Space, Avionics and Defense	www.ti.com/space-avionics-defense
Transportation and Automotive	www.ti.com/automotive
Video and Imaging	www.ti.com/video
Wireless	www.ti.com/wireless-apps

TI E2E Community Home Page

e2e.ti.com

Mailing Address: Texas Instruments, Post Office Box 655303, Dallas, Texas 75265
Copyright © 2011, Texas Instruments Incorporated