

3-MHz, LOW-POWER, LOW-NOISE, RRI/O, 1.8-V CMOS OPERATIONAL AMPLIFIER

Check for Samples: [OPA2314-EP](#)

FEATURES

- Low I_Q : 150 $\mu\text{A}/\text{ch}$ (max)
- Wide Supply Range: 1.8 V to 5.5 V
- Low Noise: 14 $\text{nV}/\sqrt{\text{Hz}}$ at 1 kHz
- Gain Bandwidth: 3 MHz
- Low Input Bias Current: 0.2 pA
- Low Offset Voltage: 0.5 mV
- Unity-Gain Stable
- Internal RF/EMI Filter

APPLICATIONS

- Battery-Powered Instruments:
 - Consumer, Industrial, Medical
 - Notebooks, Portable Media Players
- Photodiode Amplifiers
- Active Filters
- Remote Sensing
- Wireless Metering
- Handheld Test Equipment

SUPPORTS DEFENSE, AEROSPACE, AND MEDICAL APPLICATIONS

- Controlled Baseline
- One Assembly or Test Site
- One Fabrication Site
- Available in Extended (-40°C to 150°C) Temperature Range ⁽¹⁾
- Extended Product Life Cycle
- Extended Product-Change Notification
- Product Traceability

(1) Additional temperature ranges available - contact factory

DESCRIPTION

The OPA2314 is a dual channel operational amplifier and represents a new generation of low-power, general-purpose CMOS amplifiers. Rail-to-rail input and output swings, low quiescent current (150 μA typ at 5.0 V_S) combined with a wide bandwidth of 3 MHz, and very low noise (14 $\text{nV}/\sqrt{\text{Hz}}$ at 1 kHz) make this family very attractive for a variety of battery-powered applications that require a good balance between cost and performance. The low input bias current supports applications with mega-ohm source impedances.

The robust design of the OPA2314 provides ease-of-use to the circuit designer: unity-gain stability with capacitive loads of up to 300 pF, an integrated RF/EMI rejection filter, no phase reversal in overdrive conditions, and high ESD protection (4-kV HBM).

This device is optimized for low-voltage operation as low as +1.8 V (± 0.9 V) and up to +5.5 V (± 2.75 V), and is specified over the full extended temperature range of -40°C to $+150^\circ\text{C}$.

The OPA2314 (dual) is offered in a DFN-8 package.



Please be aware that an important notice concerning availability, standard warranty, and use in critical applications of Texas Instruments semiconductor products and disclaimers thereto appears at the end of this data sheet.



This integrated circuit can be damaged by ESD. Texas Instruments recommends that all integrated circuits be handled with appropriate precautions. Failure to observe proper handling and installation procedures can cause damage.

ESD damage can range from subtle performance degradation to complete device failure. Precision integrated circuits may be more susceptible to damage because very small parametric changes could cause the device not to meet its published specifications.

ORDERING INFORMATION⁽¹⁾

T _A	PACKAGE	ORDERABLE PART NUMBER	TOP-SIDE MARKING	VID NUMBER
-40°C to 150°C	DFN-8 – DRB	OPA2314ASDRBTEP	OUVS	V62/12626-01XE

- (1) For the most current package and ordering information, see the Package Option Addendum at the end of this document, or see the TI website at www.ti.com.

ABSOLUTE MAXIMUM RATINGS⁽¹⁾

Over operating free-air temperature range, unless otherwise noted.

			UNIT
Supply voltage		7	V
Signal input terminals	Voltage ⁽²⁾	(V ₋) – 0.5 to (V ₊) + 0.5	V
	Current ⁽²⁾	±10	mA
Output short-circuit ⁽³⁾		Continuous	mA
Operating temperature, T _A		-40 to +150	°C
Storage temperature, T _{stg}		-65 to +150	°C
Junction temperature, T _J		+170	°C
ESD rating	Human body model (HBM)	4000	V
	Charged device model (CDM)	1000	V
	Machine model (MM)	200	V

- (1) Stresses above these ratings may cause permanent damage. Exposure to absolute maximum conditions for extended periods may degrade device reliability. These are stress ratings only, and functional operation of the device at these or any other conditions beyond those specified is not supported.
- (2) Input terminals are diode-clamped to the power-supply rails. Input signals that can swing more than 0.5 V beyond the supply rails should be current limited to 10 mA or less.
- (3) Short-circuit to ground, one amplifier per package.

ELECTRICAL CHARACTERISTICS: $V_S = +1.8\text{ V to }+5.5\text{ V}^{(1)}$
Boldface limits apply over the specified temperature range: $T_A = -40^\circ\text{C to }+150^\circ\text{C}$.

At $T_A = +25^\circ\text{C}$, $R_L = 10\text{ k}\Omega$ connected to $V_S/2$, $V_{CM} = V_S/2$, and $V_{OUT} = V_S/2$, unless otherwise noted.

PARAMETERS		TEST CONDITIONS	MIN	TYP	MAX	UNIT
OFFSET VOLTAGE						
V_{OS}	Input offset voltage	$V_{CM} = (V_{S+}) - 1.3\text{ V}$		0.5	2.5	mV
	Over temperature	$T_A = -40^\circ\text{C to }+150^\circ\text{C}$			3.5	mV
dV_{OS}/dT	vs Temperature			1		$\mu\text{V}/^\circ\text{C}$
PSRR	vs Power supply	$V_{CM} = (V_{S+}) - 1.3\text{ V}$	78	92		dB
	$V_S = 5.5\text{ V}$, $(V_{S-}) - 0.2\text{ V} < V_{CM} < (V_{S+}) - 1.3\text{ V}$	$T_A = -40^\circ\text{C to }+150^\circ\text{C}$	72			dB
	Channel separation, dc	At dc		10		$\mu\text{V}/\text{V}$
INPUT VOLTAGE RANGE						
V_{CM}	Common-mode voltage range		$(V_-) - 0.2$		$(V_+) + 0.2$	V
CMRR	Common-mode rejection ratio	$V_S = 1.8\text{ V}$, $(V_{S-}) - 0.2\text{ V} < V_{CM} < (V_{S+}) - 1.3\text{ V}$, $T_A = -40^\circ\text{C to }+150^\circ\text{C}$	68	86		dB
		$V_S = 5.5\text{ V}$, $(V_{S-}) - 0.2\text{ V} < V_{CM} < (V_{S+}) - 1.3\text{ V}$, $T_A = -40^\circ\text{C to }+150^\circ\text{C}$	71	90		dB
		$V_S = 5.5\text{ V}$, $V_{CM} = -0.2\text{ V to }5.7\text{ V}^{(2)}$, $T_A = -40^\circ\text{C to }+150^\circ\text{C}$	60			
INPUT BIAS CURRENT						
I_B	Input bias current			± 0.2	± 10	μA
	Over temperature	$T_A = -40^\circ\text{C to }+150^\circ\text{C}$			± 2	nA
I_{OS}	Input offset current			± 0.2	± 10	μA
	Over temperature	$T_A = -40^\circ\text{C to }+150^\circ\text{C}$			± 2	nA
NOISE						
	Input voltage noise (peak-to-peak)	$f = 0.1\text{ Hz to }10\text{ Hz}$		5		μV_{PP}
e_n	Input voltage noise density	$f = 10\text{ kHz}$		13		$\text{nV}/\sqrt{\text{Hz}}$
		$f = 1\text{ kHz}$		14		$\text{nV}/\sqrt{\text{Hz}}$
i_n	Input current noise density	$f = 1\text{ kHz}$		5		$\text{fA}/\sqrt{\text{Hz}}$
INPUT CAPACITANCE						
C_{IN}	Differential	$V_S = 5.0\text{ V}$		1		pF
	Common-mode	$V_S = 5.0\text{ V}$		5		pF
OPEN-LOOP GAIN						
A_{OL}	Open-Loop Voltage Gain	$V_S = 1.8\text{ V}$, $0.2\text{ V} < V_O < (V_+) - 0.2\text{ V}$, $R_L = 10\text{ k}\Omega$	90	115		dB
		$V_S = 5.5\text{ V}$, $0.2\text{ V} < V_O < (V_+) - 0.2\text{ V}$, $R_L = 10\text{ k}\Omega$	100	128		dB
		$V_S = 1.8\text{ V}$, $0.5\text{ V} < V_O < (V_+) - 0.5\text{ V}$, $R_L = 2\text{ k}\Omega$	90	100		dB
		$V_S = 5.5\text{ V}$, $0.5\text{ V} < V_O < (V_+) - 0.5\text{ V}$, $R_L = 2\text{ k}\Omega$	94	110		dB
	Over temperature	$V_S = 5.5\text{ V}$, $0.2\text{ V} < V_O < (V_+) - 0.2\text{ V}$, $R_L = 10\text{ k}\Omega$	90	110		dB
		$V_S = 5.5\text{ V}$, $0.5\text{ V} < V_O < (V_+) - 0.2\text{ V}$, $R_L = 2\text{ k}\Omega$		100		dB
	Phase margin	$V_S = 5.0\text{ V}$, $G = +1$, $R_L = 10\text{ k}\Omega$		65		deg

(1) Parameters with MIN and/or MAX specification limits are 100% production tested, unless otherwise noted.

(2) Limits are based on characterization and statistical analysis; not production tested.

ELECTRICAL CHARACTERISTICS: $V_S = +1.8\text{ V}$ to $+5.5\text{ V}$ ⁽¹⁾ (continued)
Boldface limits apply over the specified temperature range: $T_A = -40^\circ\text{C}$ to $+150^\circ\text{C}$.

 At $T_A = +25^\circ\text{C}$, $R_L = 10\text{ k}\Omega$ connected to $V_S/2$, $V_{CM} = V_S/2$, and $V_{OUT} = V_S/2$, unless otherwise noted.

PARAMETERS		TEST CONDITIONS	MIN	TYP	MAX	UNIT
FREQUENCY RESPONSE						
GBW	Gain-bandwidth product	$V_S = 1.8\text{ V}$, $R_L = 10\text{ k}\Omega$, $C_L = 10\text{ pF}$		2.7		MHz
		$V_S = 5.0\text{ V}$, $R_L = 10\text{ k}\Omega$, $C_L = 10\text{ pF}$		3		MHz
SR	Slew rate ⁽³⁾	$V_S = 5.0\text{ V}$, $G = +1$		1.5		V/ μs
t_S	Settling time	To 0.1%, $V_S = 5.0\text{ V}$, 2-V step, $G = +1$		2.3		μs
		To 0.01%, $V_S = 5.0\text{ V}$, 2-V step, $G = +1$		3.1		μs
	Overload recovery time	$V_S = 5.0\text{ V}$, $V_{IN} \times \text{Gain} > V_S$		5.2		μs
THD+N	Total harmonic distortion + noise ⁽⁴⁾	$V_S = 5.0\text{ V}$, $V_O = 1\text{ V}_{RMS}$, $G = +1$, $f = 1\text{ kHz}$, $R_L = 10\text{ k}\Omega$		0.001		%
OUTPUT						
V_O	Voltage output swing from supply rails	$V_S = 1.8\text{ V}$, $R_L = 10\text{ k}\Omega$		5	15	mV
		$V_S = 5.5\text{ V}$, $R_L = 10\text{ k}\Omega$		5	20	mV
		$V_S = 1.8\text{ V}$, $R_L = 2\text{ k}\Omega$		15	30	mV
		$V_S = 5.5\text{ V}$, $R_L = 2\text{ k}\Omega$		22	40	mV
	Over temperature	$V_S = 5.5\text{ V}$, $R_L = 10\text{ k}\Omega$			30	mV
$V_S = 5.5\text{ V}$, $R_L = 2\text{ k}\Omega$				60	mV	
I_{SC}	Short-circuit current	$V_S = 5.0\text{ V}$		± 20		mA
R_O	Open-loop output impedance	$V_S = 5.5\text{ V}$, $f = 100\text{ Hz}$		570		Ω
POWER SUPPLY						
V_S	Specified voltage range		1.8		5.5	V
I_Q	Quiescent current per amplifier	$V_S = 1.8\text{ V}$, $I_O = 0\text{ mA}$		130	180	μA
		$V_S = 5.0\text{ V}$, $I_O = 0\text{ mA}$		150	190	μA
	Over temperature	$V_S = 5.0\text{ V}$, $I_O = 0\text{ mA}$			220	μA
	Power-on time	$V_S = 0\text{ V}$ to 5 V , to 90% I_Q level		44		μs
TEMPERATURE						
	Specified range		-40		+150	$^\circ\text{C}$
	Operating range		-40		+150	$^\circ\text{C}$
	Storage range		-65		+150	$^\circ\text{C}$

(3) Signifies the slower value of the positive or negative slew rate.

(4) Third-order filter; bandwidth = 80 kHz at -3 dB.

THERMAL INFORMATION

THERMAL METRIC ⁽¹⁾		OPA2314ASDRBTEP	UNITS
		DRB (DFN)	
		8 PINS	
θ_{JA}	Junction-to-ambient thermal resistance	53.8	$^\circ\text{C/W}$
$\theta_{JC(top)}$	Junction-to-case(top) thermal resistance	69.2	
θ_{JB}	Junction-to-board thermal resistance	20.1	
Ψ_{JT}	Junction-to-top characterization parameter	3.8	
Ψ_{JB}	Junction-to-board characterization parameter	20.0	
$\theta_{JC(bottom)}$	Junction-to-case(bottom) thermal resistance	11.6	

 (1) For more information about traditional and new thermal metrics, see the *IC Package Thermal Metrics* application report, [SPRA953](#).

PIN CONFIGURATIONS

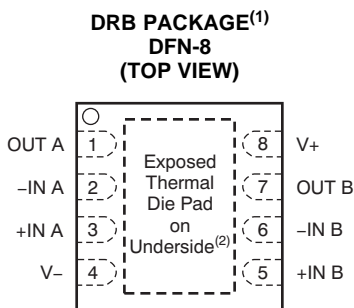

- (1) Pitch: 0,65mm.
- (2) Connect thermal pad to V-. Pad size: 1,8mm x 1,5mm.

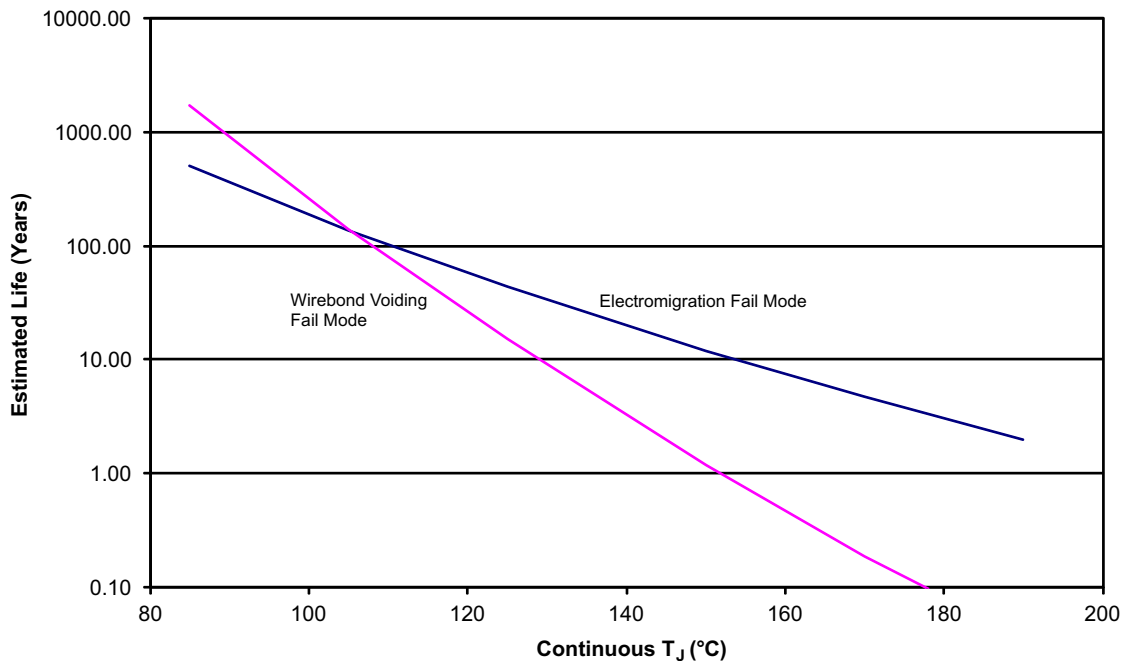

- (1) See datasheet for absolute maximum and minimum recommended operating conditions.
- (2) Silicon operating life design goal is 10 years at 105°C junction temperature (does not include package interconnect life).
- (3) Enhanced plastic product disclaimer applies.

Figure 1. OPA2314-EP Operating Life Derating Chart

TYPICAL CHARACTERISTICS

At $T_A = +25^\circ\text{C}$, $R_L = 10\text{ k}\Omega$ connected to $V_S/2$, $V_{CM} = V_S/2$, and $V_{OUT} = V_S/2$, unless otherwise noted.

OPEN-LOOP GAIN AND PHASE vs FREQUENCY

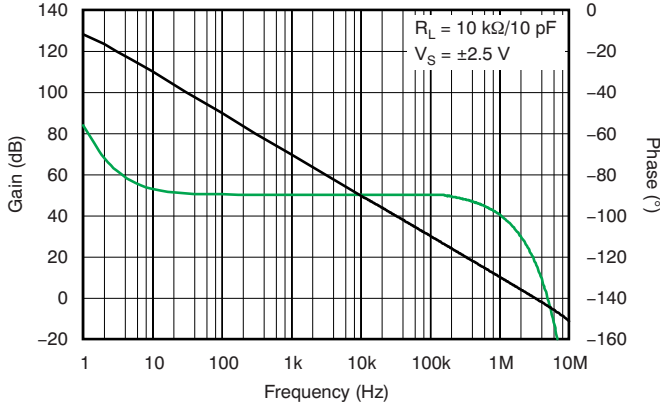

Figure 2.

OPEN-LOOP GAIN vs TEMPERATURE

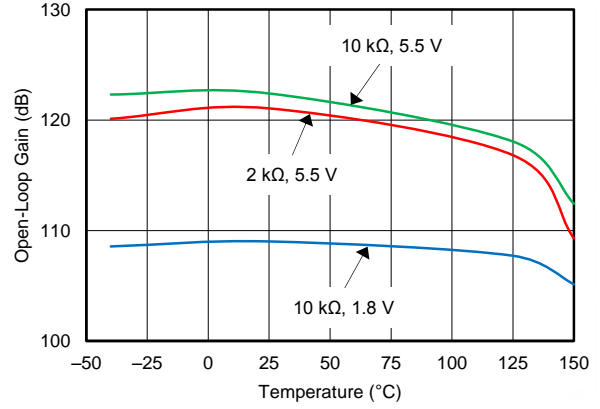

Figure 3.

QUIESCENT CURRENT vs SUPPLY

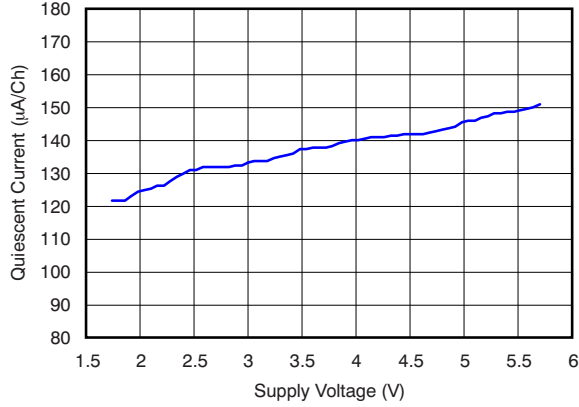

Figure 4.

QUIESCENT CURRENT vs TEMPERATURE

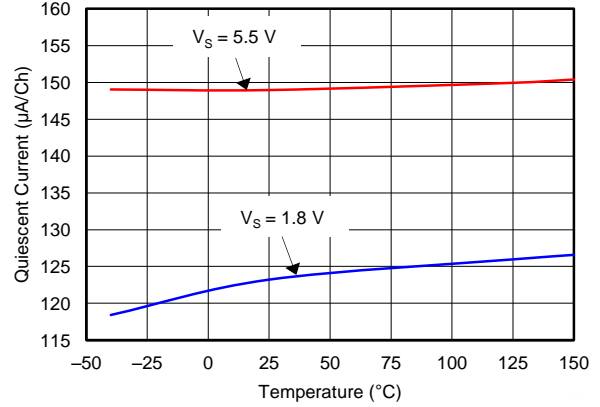

Figure 5.

OFFSET VOLTAGE PRODUCTION DISTRIBUTION

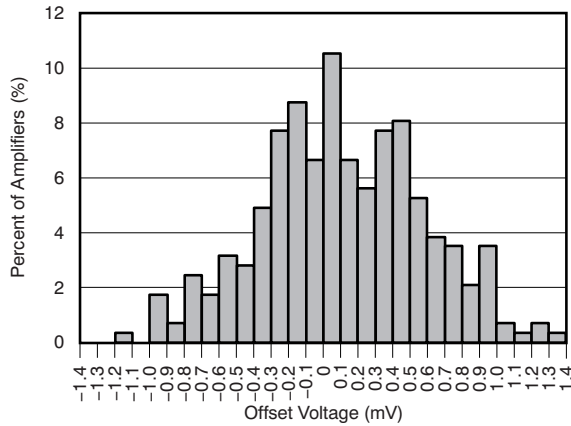

Figure 6.

OFFSET VOLTAGE DRIFT DISTRIBUTION

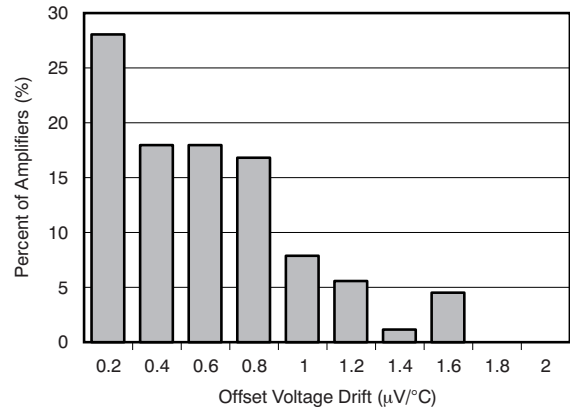

Figure 7.

TYPICAL CHARACTERISTICS (continued)

At $T_A = +25^\circ\text{C}$, $R_L = 10\text{ k}\Omega$ connected to $V_S/2$, $V_{CM} = V_S/2$, and $V_{OUT} = V_S/2$, unless otherwise noted.

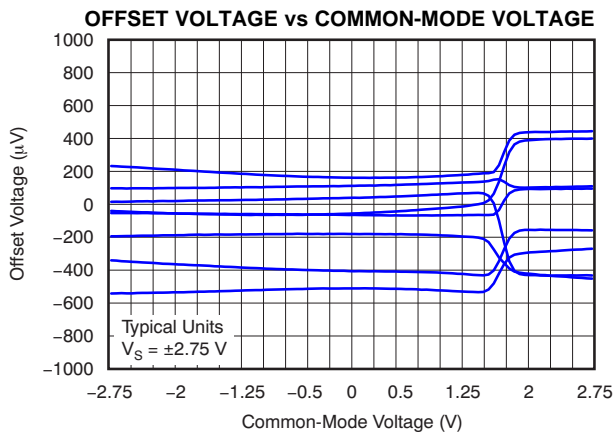

Figure 8.

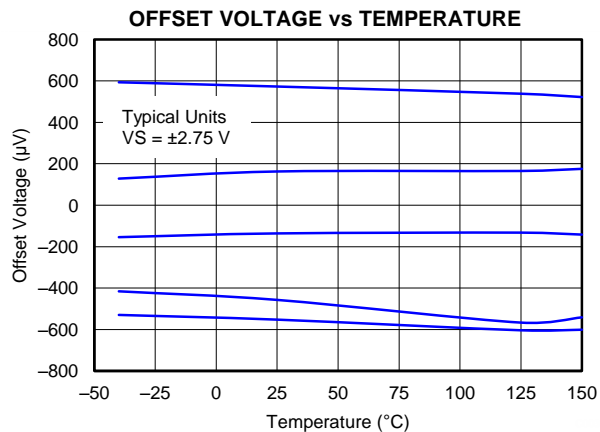

Figure 9.

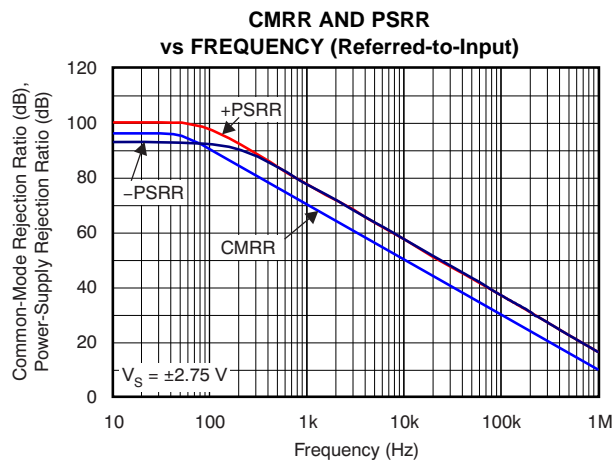

Figure 10.

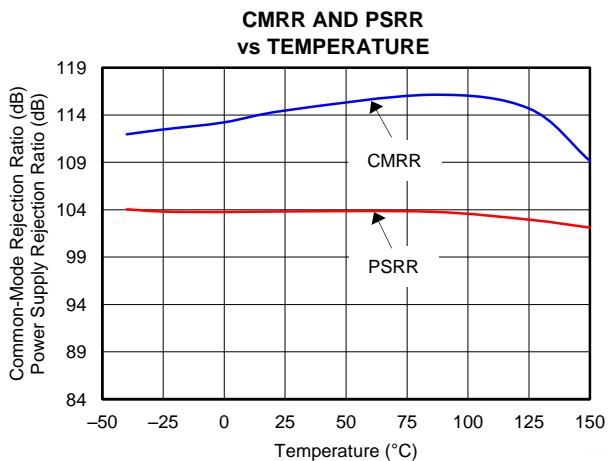

Figure 11.

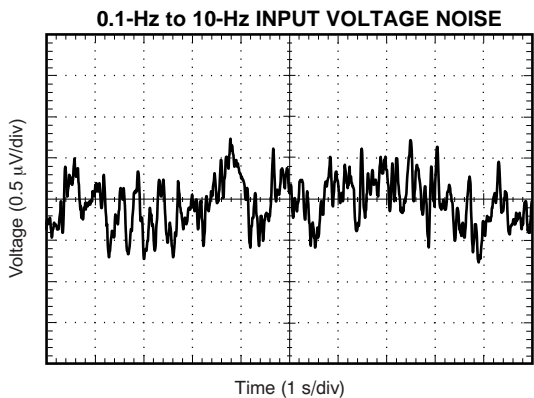

Figure 12.

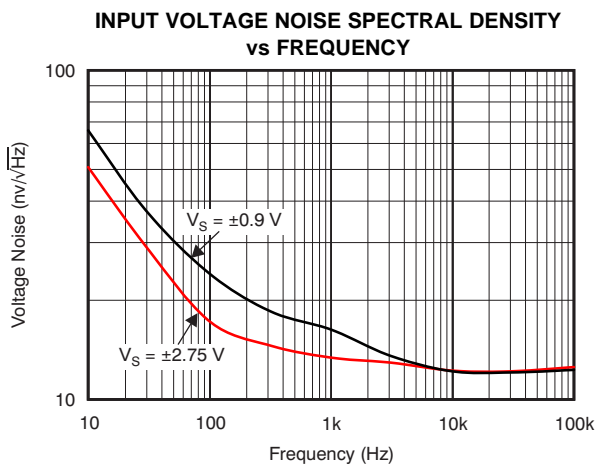

Figure 13.

TYPICAL CHARACTERISTICS (continued)

At $T_A = +25^\circ\text{C}$, $R_L = 10\text{ k}\Omega$ connected to $V_S/2$, $V_{CM} = V_S/2$, and $V_{OUT} = V_S/2$, unless otherwise noted.

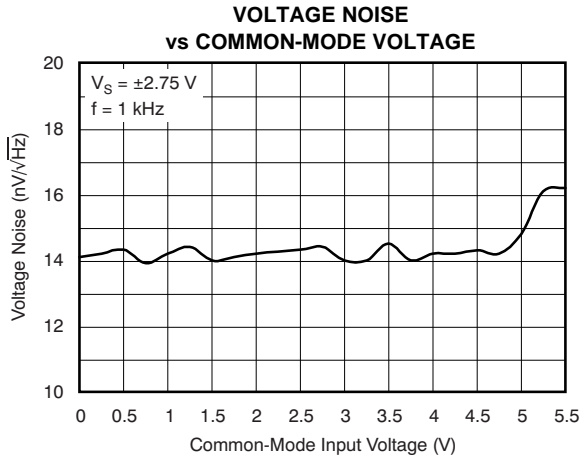

Figure 14.

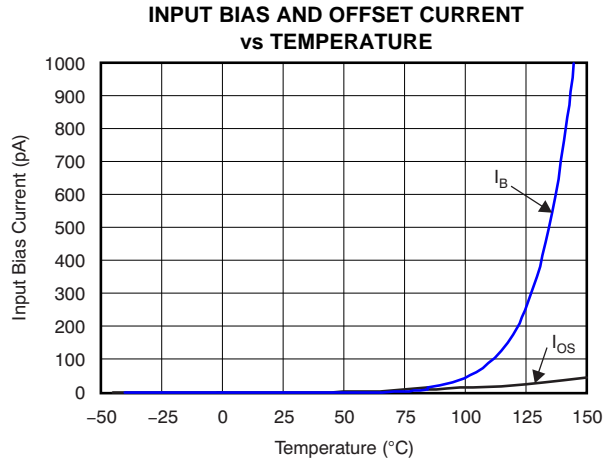

Figure 15.

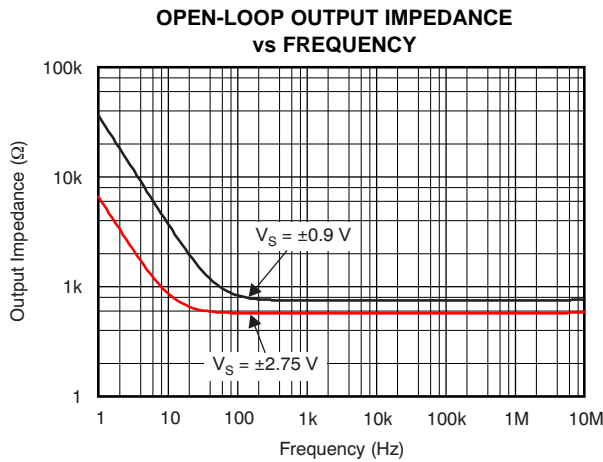

Figure 16.

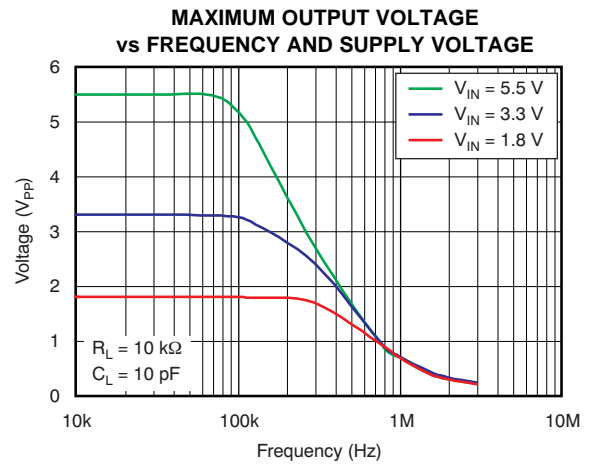

Figure 17.

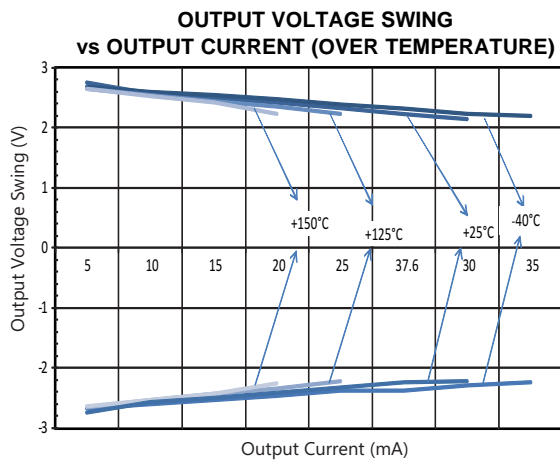

Figure 18.

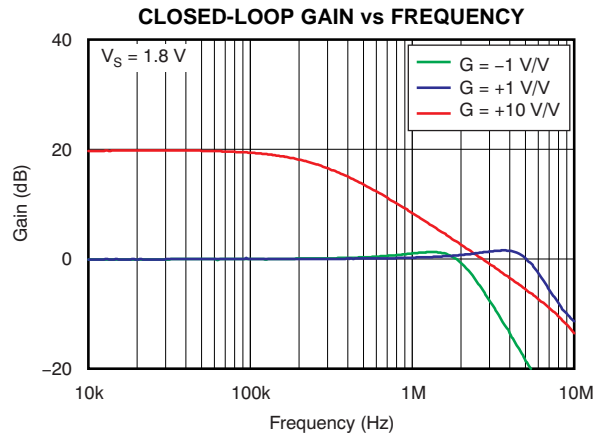

Figure 19.

TYPICAL CHARACTERISTICS (continued)

At $T_A = +25^\circ\text{C}$, $R_L = 10\text{ k}\Omega$ connected to $V_S/2$, $V_{CM} = V_S/2$, and $V_{OUT} = V_S/2$, unless otherwise noted.

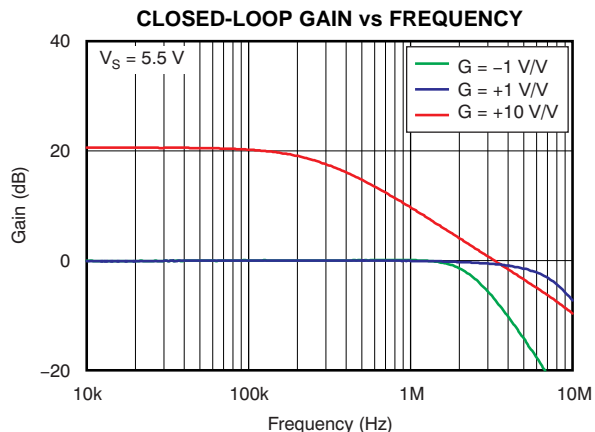

Figure 20.

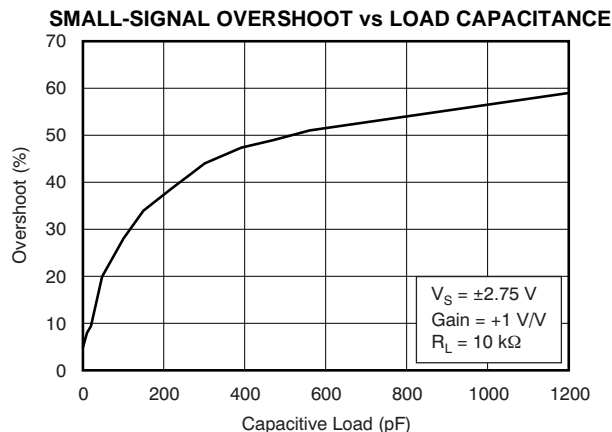

Figure 21.

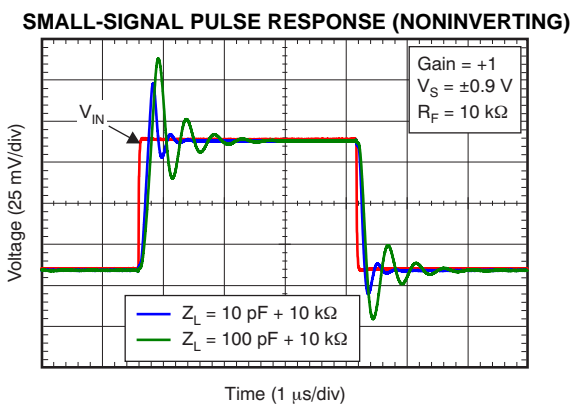

Figure 22.

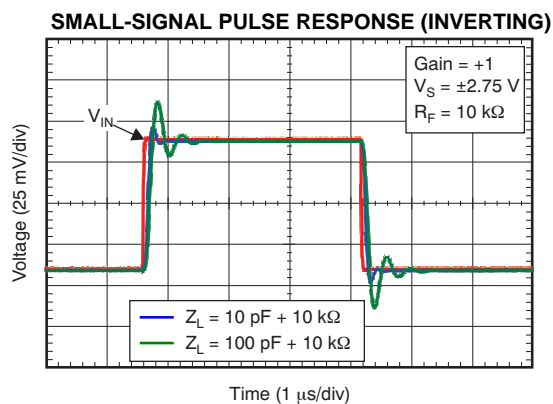

Figure 23.

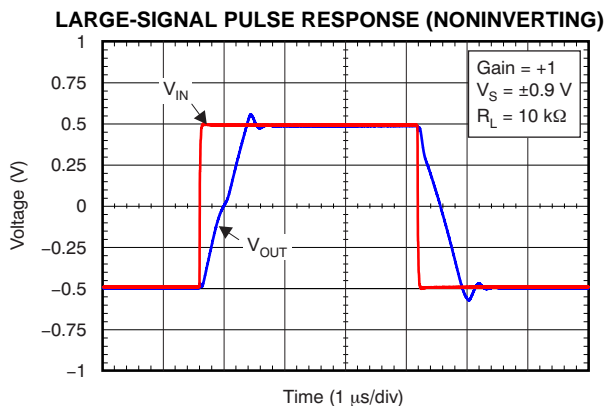

Figure 24.

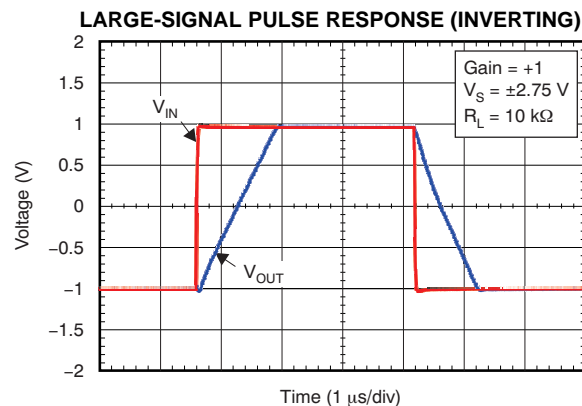

Figure 25.

TYPICAL CHARACTERISTICS (continued)

At $T_A = +25^\circ\text{C}$, $R_L = 10\text{ k}\Omega$ connected to $V_S/2$, $V_{CM} = V_S/2$, and $V_{OUT} = V_S/2$, unless otherwise noted.

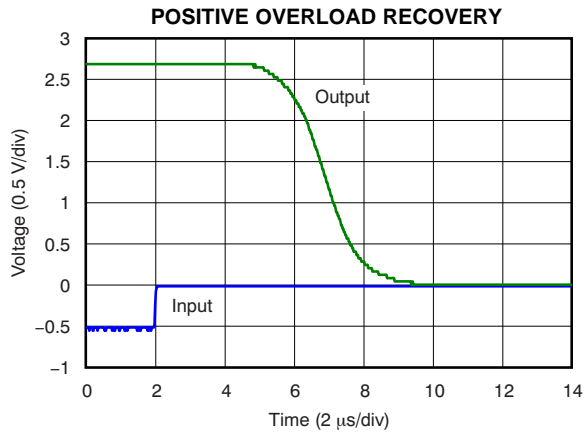

Figure 26.

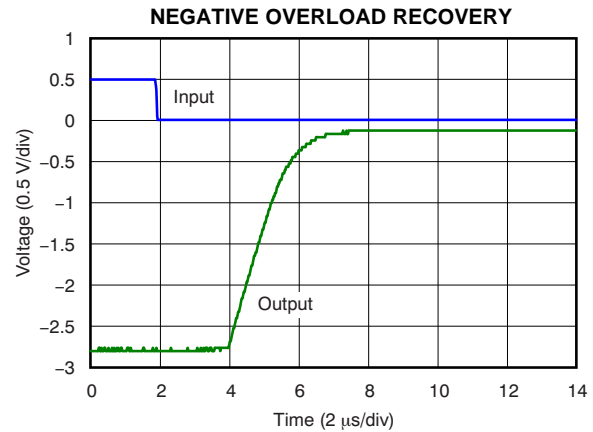

Figure 27.

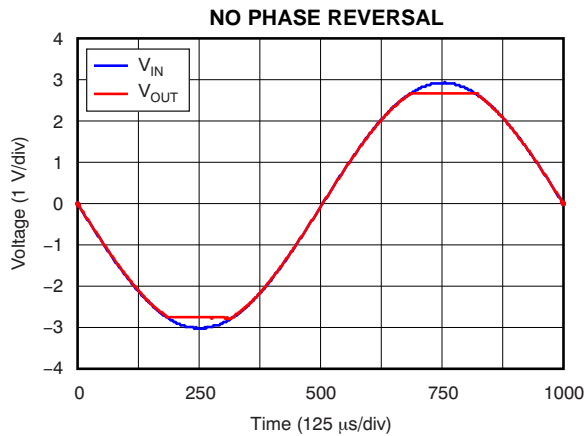

Figure 28.

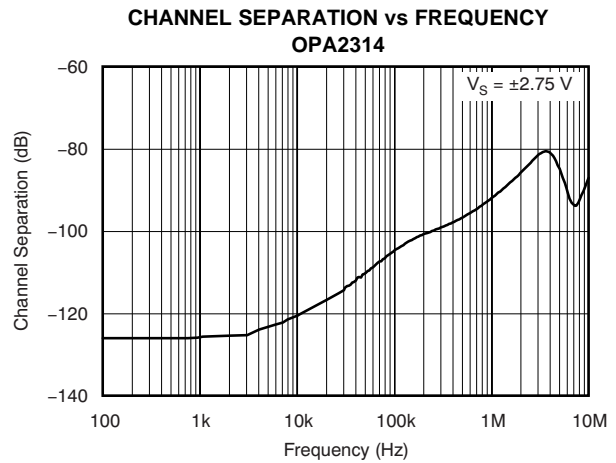

Figure 29.

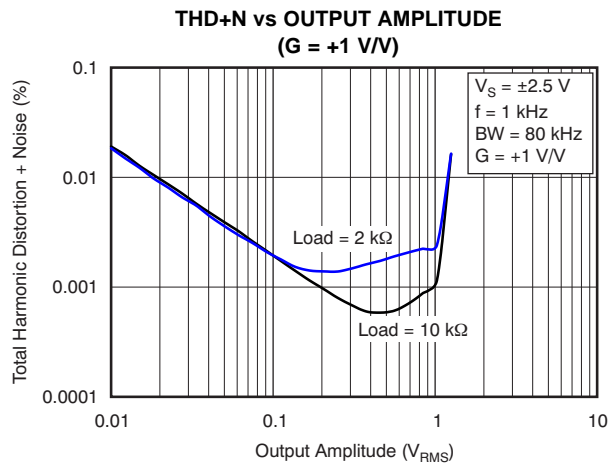

Figure 30.

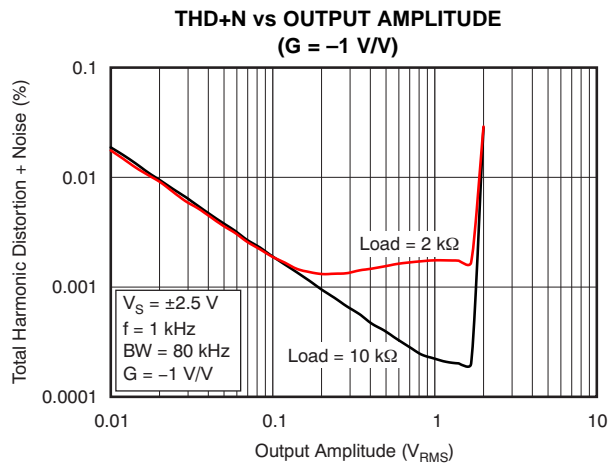

Figure 31.

TYPICAL CHARACTERISTICS (continued)

At $T_A = +25^\circ\text{C}$, $R_L = 10\text{ k}\Omega$ connected to $V_S/2$, $V_{CM} = V_S/2$, and $V_{OUT} = V_S/2$, unless otherwise noted.

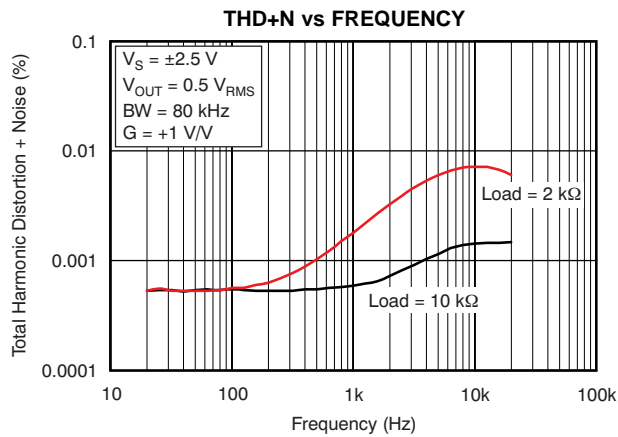

Figure 32.

**ELECTROMAGNETIC INTERFERENCE REJECTION RATIO
Referred to Noninverting Input (EMIRR IN+) vs FREQUENCY**

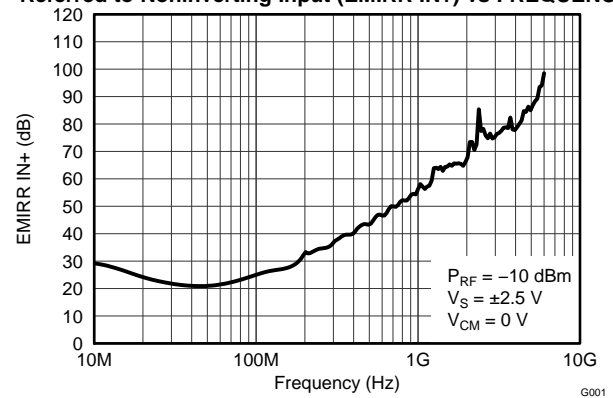

Figure 33.

APPLICATION INFORMATION

The OPA2314 is a low-power, rail-to-rail input/output operational amplifier specifically designed for portable applications. This device operates from 1.8 V to 5.5 V, is unity-gain stable, and suitable for a wide range of general-purpose applications. The class AB output stage is capable of driving $\leq 10\text{-k}\Omega$ loads connected to any point between $V+$ and ground. The input common-mode voltage range includes both rails, and allows the OPA2314 to be used in virtually any single-supply application. Rail-to-rail input and output swing significantly increases dynamic range, especially in low-supply applications, and makes them ideal for driving sampling analog-to-digital converters (ADCs).

The OPA2314 features 3-MHz bandwidth and $1.5\text{-V}/\mu\text{s}$ slew rate with only $150\text{-}\mu\text{A}$ supply current per channel, providing good ac performance at very low power consumption. DC applications are also well served with a very low input noise voltage of $14\text{ nV}/\sqrt{\text{Hz}}$ at 1 kHz, low input bias current (0.2 pA), and an input offset voltage of 0.5 mV (typical).

Operating Voltage

The OPA2314 is fully specified and ensured for operation from $+1.8\text{ V}$ to $+5.5\text{ V}$. In addition, many specifications apply from -40°C to $+150^\circ\text{C}$. Parameters that vary significantly with operating voltages or temperature are shown in the [Typical Characteristics](#) graphs. Power-supply pins should be bypassed with $0.01\text{-}\mu\text{F}$ ceramic capacitors.

Rail-to-Rail Input

The input common-mode voltage range of the OPA2314 extends 200 mV beyond the supply rails. This performance is achieved with a complementary input stage: an N-channel input differential pair in parallel with a P-channel differential pair, as shown in [Figure 34](#). The N-channel pair is active for input voltages close to the positive rail, typically $(V+) - 1.3\text{ V}$ to 200 mV above the positive supply, while the P-channel pair is on for inputs from 200 mV below the negative supply to approximately $(V+) - 1.3\text{ V}$. There is a small transition region, typically $(V+) - 1.4\text{ V}$ to $(V+) - 1.2\text{ V}$, in which both pairs are on. This 200-mV transition region can vary up to 300 mV with process variation. Thus, the transition region (both stages on) can range from $(V+) - 1.7\text{ V}$ to $(V+) - 1.5\text{ V}$ on the low end, up to $(V+) - 1.1\text{ V}$ to $(V+) - 0.9\text{ V}$ on the high end. Within this transition region, PSRR, CMRR, offset voltage, offset drift, and THD may be degraded compared to device operation outside this region.

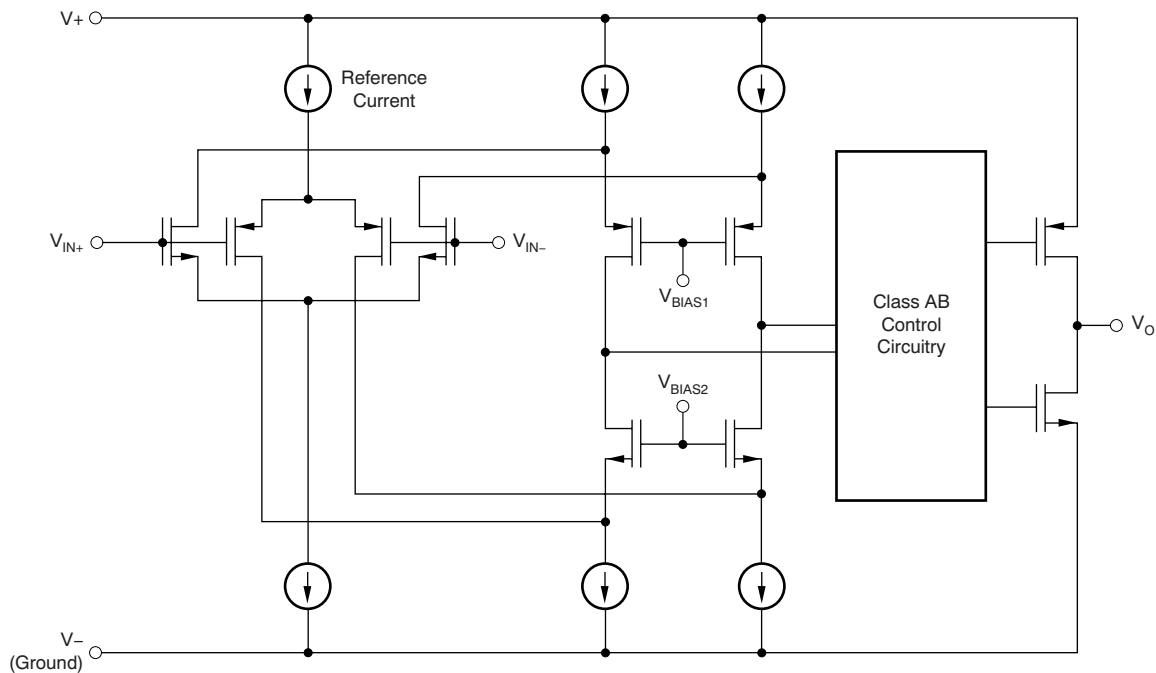

Figure 34. Simplified Schematic

Input and ESD Protection

The OPA2314 incorporates internal electrostatic discharge (ESD) protection circuits on all pins. In the case of input and output pins, this protection primarily consists of current steering diodes connected between the input and power-supply pins. These ESD protection diodes also provide in-circuit, input overdrive protection, as long as the current is limited to 10 mA as stated in the [Absolute Maximum Ratings](#). [Figure 35](#) shows how a series input resistor may be added to the driven input to limit the input current. The added resistor contributes thermal noise at the amplifier input and its value should be kept to a minimum in noise-sensitive applications.

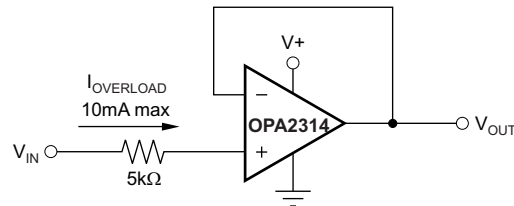

Figure 35. Input Current Protection

Common-Mode Rejection Ratio (CMRR)

CMRR for the OPA2314 is specified in several ways so the best match for a given application may be used; see the [Electrical Characteristics](#). First, the CMRR of the device in the common-mode range below the transition region [$V_{CM} < (V+) - 1.3 \text{ V}$] is given. This specification is the best indicator of the capability of the device when the application requires use of one of the differential input pairs. Second, the CMRR over the entire common-mode range is specified at ($V_{CM} = -0.2 \text{ V}$ to 5.7 V). This last value includes the variations seen through the transition region (see [Figure 8](#)).

EMI Susceptibility and Input Filtering

Operational amplifiers vary with regard to the susceptibility of the device to electromagnetic interference (EMI). If conducted EMI enters the op amp, the dc offset observed at the amplifier output may shift from its nominal value while EMI is present. This shift is a result of signal rectification associated with the internal semiconductor junctions. While all op amp pin functions can be affected by EMI, the signal input pins are likely to be the most susceptible. The OPA2314 operational amplifier incorporates an internal input low-pass filter that reduces the amplifiers response to EMI. Both common-mode and differential mode filtering are provided by this filter. The filter is designed for a cutoff frequency of approximately 80 MHz (-3 dB), with a roll-off of 20 dB per decade.

Texas Instruments has developed the ability to accurately measure and quantify the immunity of an operational amplifier over a broad frequency spectrum extending from 10 MHz to 6 GHz. The EMI rejection ratio (EMIRR) metric allows op amps to be directly compared by the EMI immunity. [Figure 33](#) shows the results of this testing on the OPAx314. Detailed information can also be found in the application report, *EMI Rejection Ratio of Operational Amplifiers* ([SBOA128](#)), available for download from the TI website.

Rail-to-Rail Output

Designed as a micro-power, low-noise operational amplifier, the OPA2314 delivers a robust output drive capability. A class AB output stage with common-source transistors is used to achieve full rail-to-rail output swing capability. For resistive loads up to 10 kΩ, the output swings typically to within 5 mV of either supply rail regardless of the power-supply voltage applied. Different load conditions change the ability of the amplifier to swing close to the rails, as can be seen in the typical characteristic graph, [Output Voltage Swing vs Output Current](#).

Capacitive Load and Stability

The OPA2314 is designed to be used in applications where driving a capacitive load is required. As with all op amps, there may be specific instances where the OPA2314 can become unstable. The particular op amp circuit configuration, layout, gain, and output loading are some of the factors to consider when establishing whether or not an amplifier is stable in operation. An op amp in the unity-gain (+1-V/V) buffer configuration that drives a capacitive load exhibits a greater tendency to be unstable than an amplifier operated at a higher noise gain. The capacitive load, in conjunction with the op amp output resistance, creates a pole within the feedback loop that degrades the phase margin. The degradation of the phase margin increases as the capacitive loading increases. When operating in the unity-gain configuration, the OPA2314 remains stable with a pure capacitive load up to approximately 1 nF. The equivalent series resistance (ESR) of some very large capacitors (C_L greater than 1 μ F) is sufficient to alter the phase characteristics in the feedback loop such that the amplifier remains stable. Increasing the amplifier closed-loop gain allows the amplifier to drive increasingly larger capacitance. This increased capability is evident when observing the overshoot response of the amplifier at higher voltage gains. See the typical characteristic graph, [Small-Signal Overshoot vs. Capacitive Load](#).

One technique for increasing the capacitive load drive capability of the amplifier operating in a unity-gain configuration is to insert a small resistor, typically 10 Ω to 20 Ω , in series with the output, as shown in [Figure 36](#). This resistor significantly reduces the overshoot and ringing associated with large capacitive loads. One possible problem with this technique, however, is that a voltage divider is created with the added series resistor and any resistor connected in parallel with the capacitive load. The voltage divider introduces a gain error at the output that reduces the output swing.

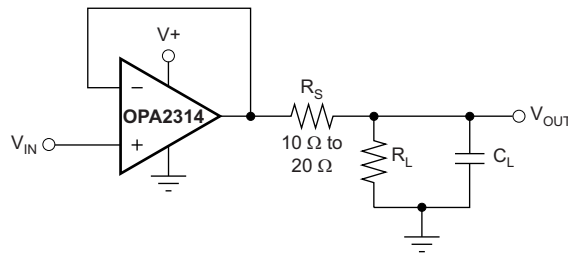

Figure 36. Improving Capacitive Load Drive

DFN Package

The OPA2314 (dual version) uses the DFN style package (also known as SON); this package is a QFN with contacts on only two sides of the package bottom. This leadless package maximizes printed circuit board (PCB) space and offers enhanced thermal and electrical characteristics through an exposed pad. One of the primary advantages of the DFN package is its low, 0.9-mm height. DFN packages are physically small, have a smaller routing area, improved thermal performance, reduced electrical parasitics, and use a pinout scheme that is consistent with other commonly-used packages, such as SO and MSOP. Additionally, the absence of external leads eliminates bent-lead issues.

The DFN package can easily be mounted using standard PCB assembly techniques. See Application Note, [QFN/SO_N PCB Attachment \(SLUA271\)](#) and Application Report, [Quad Flatpack No-Lead Logic Packages \(SCBA017\)](#), both available for download from the TI website at www.ti.com.

NOTE: The exposed leadframe die pad on the bottom of the DFN package should be connected to the most negative potential (V-).

APPLICATION EXAMPLES

General Configurations

When receiving low-level signals, limiting the bandwidth of the incoming signals into the system is often required. The simplest way to establish this limited bandwidth is to place an RC filter at the noninverting terminal of the amplifier, as [Figure 37](#) illustrates.

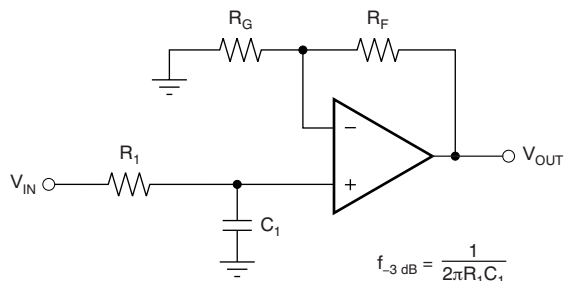

$$f_{-3\text{ dB}} = \frac{1}{2\pi R_1 C_1}$$

$$\frac{V_{\text{OUT}}}{V_{\text{IN}}} = \left(1 + \frac{R_F}{R_G}\right) \left(\frac{1}{1 + sR_1 C_1}\right)$$

Figure 37. Single-Pole Low-Pass Filter

If even more attenuation is needed, a multiple pole filter is required. The Sallen-Key filter can be used for this task, as [Figure 38](#) shows. For best results, the amplifier should have a bandwidth that is eight to 10 times the filter frequency bandwidth. Failure to follow this guideline can result in phase shift of the amplifier.

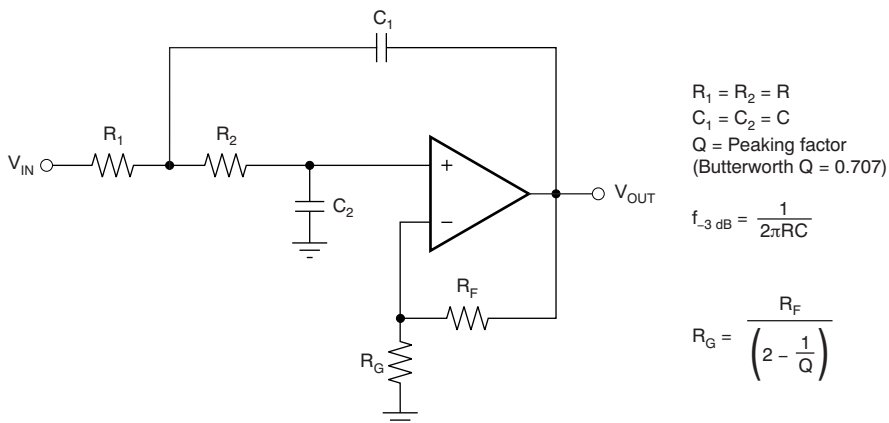

$$\begin{aligned} R_1 &= R_2 = R \\ C_1 &= C_2 = C \\ Q &= \text{Peaking factor} \\ &(\text{Butterworth } Q = 0.707) \end{aligned}$$

$$f_{-3\text{ dB}} = \frac{1}{2\pi RC}$$

$$R_G = \frac{R_F}{\left(2 - \frac{1}{Q}\right)}$$

Figure 38. Two-Pole Low-Pass Sallen-Key Filter

PACKAGING INFORMATION

Orderable Device	Status (1)	Package Type	Package Drawing	Pins	Package Qty	Eco Plan (2)	Lead/Ball Finish	MSL Peak Temp (3)	Op Temp (°C)	Top-Side Markings (4)	Samples
OPA2314ASDRBREP	PREVIEW	SON	DRB	8	3000	Green (RoHS & no Sb/Br)	CU NIPDAU	Level-2-260C-1 YEAR	-40 to 150	OUVS	
OPA2314ASDRBTEP	ACTIVE	SON	DRB	8	250	Green (RoHS & no Sb/Br)	CU NIPDAU	Level-2-260C-1 YEAR	-40 to 150	OUVS	Samples
V62/12626-01XE	ACTIVE	SON	DRB	8	250	Green (RoHS & no Sb/Br)	CU NIPDAU	Level-2-260C-1 YEAR	-40 to 150	OUVS	Samples

(1) The marketing status values are defined as follows:

ACTIVE: Product device recommended for new designs.

LIFEBUY: TI has announced that the device will be discontinued, and a lifetime-buy period is in effect.

NRND: Not recommended for new designs. Device is in production to support existing customers, but TI does not recommend using this part in a new design.

PREVIEW: Device has been announced but is not in production. Samples may or may not be available.

OBSOLETE: TI has discontinued the production of the device.

(2) Eco Plan - The planned eco-friendly classification: Pb-Free (RoHS), Pb-Free (RoHS Exempt), or Green (RoHS & no Sb/Br) - please check <http://www.ti.com/productcontent> for the latest availability information and additional product content details.

TBD: The Pb-Free/Green conversion plan has not been defined.

Pb-Free (RoHS): TI's terms "Lead-Free" or "Pb-Free" mean semiconductor products that are compatible with the current RoHS requirements for all 6 substances, including the requirement that lead not exceed 0.1% by weight in homogeneous materials. Where designed to be soldered at high temperatures, TI Pb-Free products are suitable for use in specified lead-free processes.

Pb-Free (RoHS Exempt): This component has a RoHS exemption for either 1) lead-based flip-chip solder bumps used between the die and package, or 2) lead-based die adhesive used between the die and leadframe. The component is otherwise considered Pb-Free (RoHS compatible) as defined above.

Green (RoHS & no Sb/Br): TI defines "Green" to mean Pb-Free (RoHS compatible), and free of Bromine (Br) and Antimony (Sb) based flame retardants (Br or Sb do not exceed 0.1% by weight in homogeneous material)

(3) MSL, Peak Temp. -- The Moisture Sensitivity Level rating according to the JEDEC industry standard classifications, and peak solder temperature.

(4) Only one of markings shown within the brackets will appear on the physical device.

Important Information and Disclaimer: The information provided on this page represents TI's knowledge and belief as of the date that it is provided. TI bases its knowledge and belief on information provided by third parties, and makes no representation or warranty as to the accuracy of such information. Efforts are underway to better integrate information from third parties. TI has taken and continues to take reasonable steps to provide representative and accurate information but may not have conducted destructive testing or chemical analysis on incoming materials and chemicals. TI and TI suppliers consider certain information to be proprietary, and thus CAS numbers and other limited information may not be available for release.

In no event shall TI's liability arising out of such information exceed the total purchase price of the TI part(s) at issue in this document sold by TI to Customer on an annual basis.

OTHER QUALIFIED VERSIONS OF OPA2314-EP :

- Catalog: [OPA2314](#)

NOTE: Qualified Version Definitions:

- Catalog - TI's standard catalog product

DRB (S-PVSON-N8)

PLASTIC SMALL OUTLINE NO-LEAD

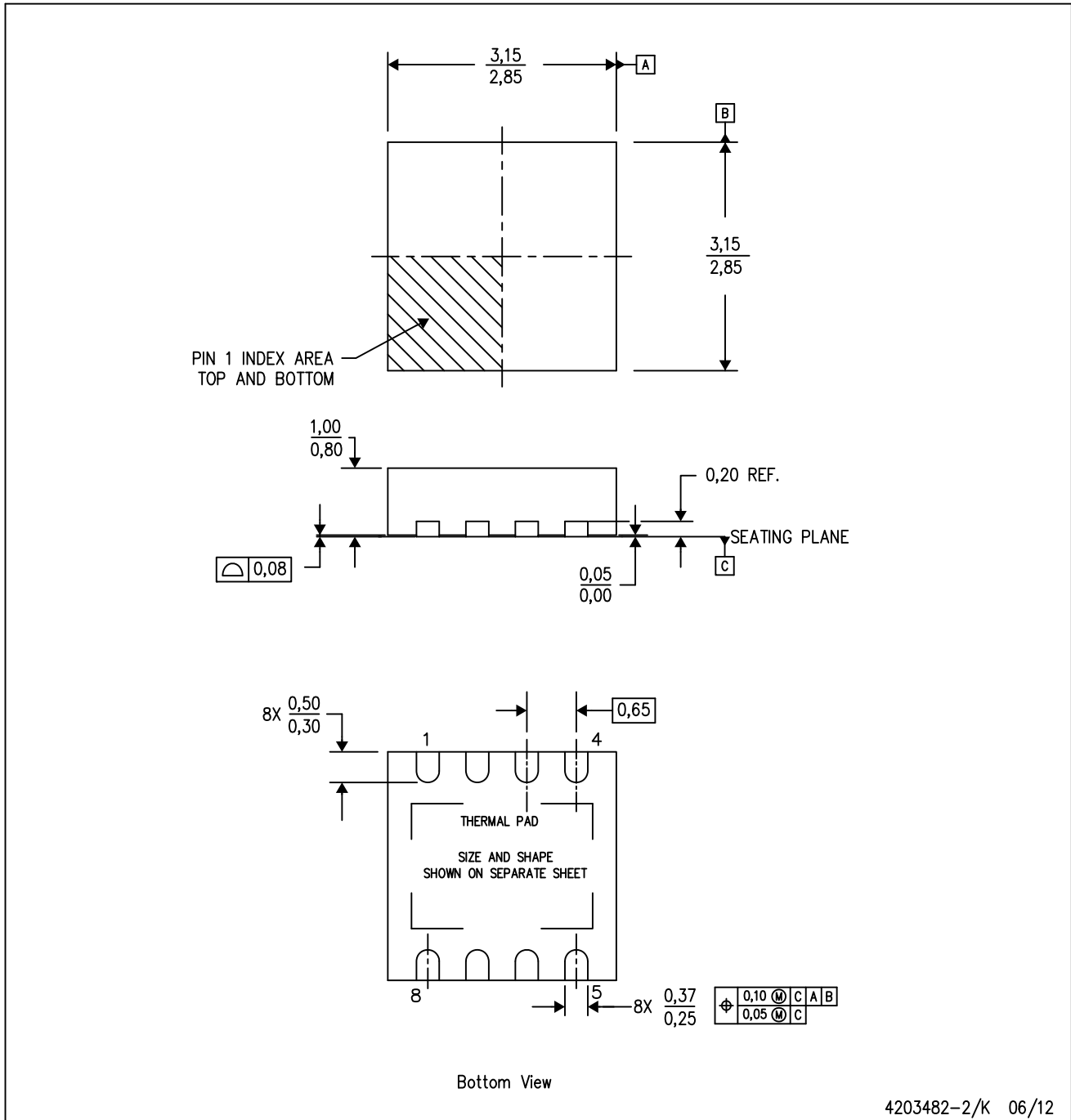

- NOTES:
- All linear dimensions are in millimeters. Dimensioning and tolerancing per ASME Y14.5M-1994.
 - This drawing is subject to change without notice.
 - Small Outline No-Lead (SON) package configuration.
 - The package thermal pad must be soldered to the board for thermal and mechanical performance.
 - See the additional figure in the Product Data Sheet for details regarding the exposed thermal pad features and dimensions.

THERMAL PAD MECHANICAL DATA

DRB (S-PVSON-N8)

PLASTIC SMALL OUTLINE NO-LEAD

THERMAL INFORMATION

This package incorporates an exposed thermal pad that is designed to be attached directly to an external heatsink. The thermal pad must be soldered directly to the printed circuit board (PCB). After soldering, the PCB can be used as a heatsink. In addition, through the use of thermal vias, the thermal pad can be attached directly to the appropriate copper plane shown in the electrical schematic for the device, or alternatively, can be attached to a special heatsink structure designed into the PCB. This design optimizes the heat transfer from the integrated circuit (IC).

For information on the Quad Flatpack No-Lead (QFN) package and its advantages, refer to Application Report, QFN/SON PCB Attachment, Texas Instruments Literature No. SLUA271. This document is available at www.ti.com.

The exposed thermal pad dimensions for this package are shown in the following illustration.

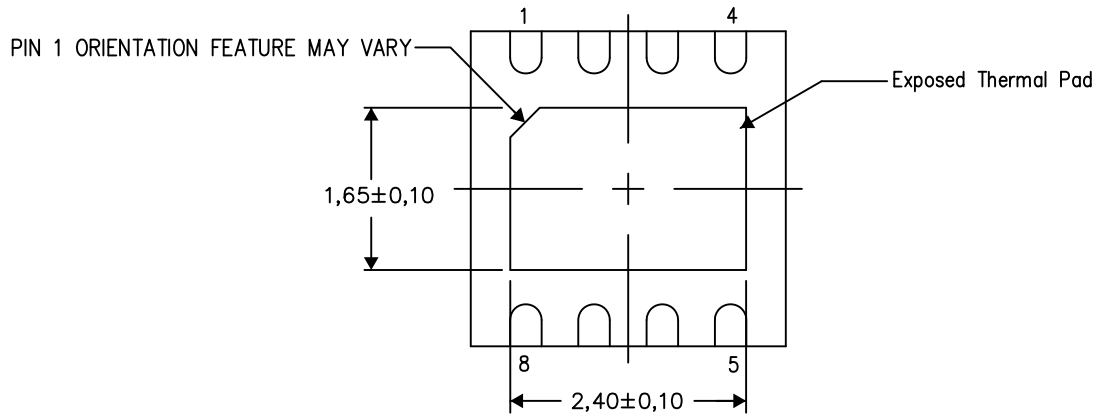

Bottom View

Exposed Thermal Pad Dimensions

4206340-3/N 09/12

NOTE: All linear dimensions are in millimeters

IMPORTANT NOTICE

Texas Instruments Incorporated and its subsidiaries (TI) reserve the right to make corrections, enhancements, improvements and other changes to its semiconductor products and services per JESD46, latest issue, and to discontinue any product or service per JESD48, latest issue. Buyers should obtain the latest relevant information before placing orders and should verify that such information is current and complete. All semiconductor products (also referred to herein as "components") are sold subject to TI's terms and conditions of sale supplied at the time of order acknowledgment.

TI warrants performance of its components to the specifications applicable at the time of sale, in accordance with the warranty in TI's terms and conditions of sale of semiconductor products. Testing and other quality control techniques are used to the extent TI deems necessary to support this warranty. Except where mandated by applicable law, testing of all parameters of each component is not necessarily performed.

TI assumes no liability for applications assistance or the design of Buyers' products. Buyers are responsible for their products and applications using TI components. To minimize the risks associated with Buyers' products and applications, Buyers should provide adequate design and operating safeguards.

TI does not warrant or represent that any license, either express or implied, is granted under any patent right, copyright, mask work right, or other intellectual property right relating to any combination, machine, or process in which TI components or services are used. Information published by TI regarding third-party products or services does not constitute a license to use such products or services or a warranty or endorsement thereof. Use of such information may require a license from a third party under the patents or other intellectual property of the third party, or a license from TI under the patents or other intellectual property of TI.

Reproduction of significant portions of TI information in TI data books or data sheets is permissible only if reproduction is without alteration and is accompanied by all associated warranties, conditions, limitations, and notices. TI is not responsible or liable for such altered documentation. Information of third parties may be subject to additional restrictions.

Resale of TI components or services with statements different from or beyond the parameters stated by TI for that component or service voids all express and any implied warranties for the associated TI component or service and is an unfair and deceptive business practice. TI is not responsible or liable for any such statements.

Buyer acknowledges and agrees that it is solely responsible for compliance with all legal, regulatory and safety-related requirements concerning its products, and any use of TI components in its applications, notwithstanding any applications-related information or support that may be provided by TI. Buyer represents and agrees that it has all the necessary expertise to create and implement safeguards which anticipate dangerous consequences of failures, monitor failures and their consequences, lessen the likelihood of failures that might cause harm and take appropriate remedial actions. Buyer will fully indemnify TI and its representatives against any damages arising out of the use of any TI components in safety-critical applications.

In some cases, TI components may be promoted specifically to facilitate safety-related applications. With such components, TI's goal is to help enable customers to design and create their own end-product solutions that meet applicable functional safety standards and requirements. Nonetheless, such components are subject to these terms.

No TI components are authorized for use in FDA Class III (or similar life-critical medical equipment) unless authorized officers of the parties have executed a special agreement specifically governing such use.

Only those TI components which TI has specifically designated as military grade or "enhanced plastic" are designed and intended for use in military/aerospace applications or environments. Buyer acknowledges and agrees that any military or aerospace use of TI components which have **not** been so designated is solely at the Buyer's risk, and that Buyer is solely responsible for compliance with all legal and regulatory requirements in connection with such use.

TI has specifically designated certain components as meeting ISO/TS16949 requirements, mainly for automotive use. In any case of use of non-designated products, TI will not be responsible for any failure to meet ISO/TS16949.

Products

Audio	www.ti.com/audio
Amplifiers	amplifier.ti.com
Data Converters	dataconverter.ti.com
DLP® Products	www.dlp.com
DSP	dsp.ti.com
Clocks and Timers	www.ti.com/clocks
Interface	interface.ti.com
Logic	logic.ti.com
Power Mgmt	power.ti.com
Microcontrollers	microcontroller.ti.com
RFID	www.ti-rfid.com
OMAP Applications Processors	www.ti.com/omap
Wireless Connectivity	www.ti.com/wirelessconnectivity

Applications

Automotive and Transportation	www.ti.com/automotive
Communications and Telecom	www.ti.com/communications
Computers and Peripherals	www.ti.com/computers
Consumer Electronics	www.ti.com/consumer-apps
Energy and Lighting	www.ti.com/energy
Industrial	www.ti.com/industrial
Medical	www.ti.com/medical
Security	www.ti.com/security
Space, Avionics and Defense	www.ti.com/space-avionics-defense
Video and Imaging	www.ti.com/video

TI E2E Community

e2e.ti.com