

1A, Low-Dropout Voltage Regulator for C2000™

Check for Samples: [TPS73734](#)

FEATURES

- Optimal Output Voltage for I/O Rail of C2000
- Good Line/Load Transient Response for MCUs
- 1A LDO Voltage Regulator with Enable
- Very Low Drop Out Voltage: 130mV (typ) at 1A
- Reverse Current Protection
- Stable with 1µF Ceramic Capacitor
- 1% Initial Accuracy
- 5-Pin SOT-223 Package

APPLICATIONS

- C2000 I/O Power Rail Supply

DESCRIPTION

The TPS73734 is a low-dropout (LDO) voltage regulator that offers very good line and load transient response, even with a small 1.0µF ceramic output capacitor. The TPS73734 is suitable for driving C2000 MCUs from Texas Instruments. The device offers very low dropout voltage which helps to reduce power loss.

In combination with a voltage supervisor such as the [TPS3808G01](#), the TPS73734 can deliver tight V_{IO} voltages and generate accurate power-good signals that meet or exceed power requirements for the C2000.

The TPS73734 is available in a 5-pin SOT-223 package.

DCQ PACKAGE
SOT223
(TOP VIEW)

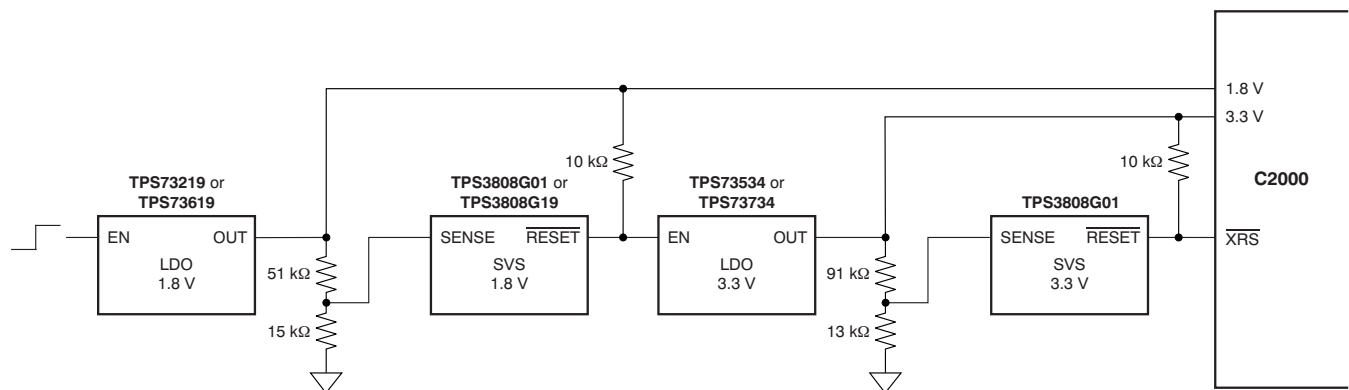
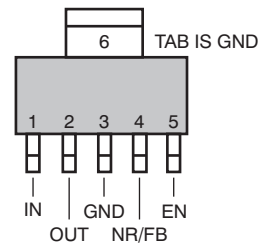

Figure 1. Typical Application



Please be aware that an important notice concerning availability, standard warranty, and use in critical applications of Texas Instruments semiconductor products and disclaimers thereto appears at the end of this data sheet.

C2000 is a trademark of Texas Instruments.

All other trademarks are the property of their respective owners.



This integrated circuit can be damaged by ESD. Texas Instruments recommends that all integrated circuits be handled with appropriate precautions. Failure to observe proper handling and installation procedures can cause damage.

ESD damage can range from subtle performance degradation to complete device failure. Precision integrated circuits may be more susceptible to damage because very small parametric changes could cause the device not to meet its published specifications.

ORDERING INFORMATION⁽¹⁾

PRODUCT	V _{OUT} ⁽²⁾
TPS737xx yy yz	XX is nominal output voltage (for example, 25 = 2.5V ⁽³⁾). YYY is package designator. Z is package quantity.

- (1) For the most current package and ordering information see the Package Option Addendum at the end of this document, or visit the device product folder at www.ti.com.
- (2) Most output voltages of 1.25V and 1.3V to 5.0V in 100mV increments are available on a quick-turn basis using innovative factory package-level programming. Minimum order quantities apply; contact factory for details and availability.
- (3) For fixed 1.20V operation, tie FB to OUT.

ABSOLUTE MAXIMUM RATINGS⁽¹⁾

Over operating free-air temperature range unless otherwise noted.

PARAMETER	TPS73734	UNIT
V _{IN} range	–0.3 to +6.0	V
V _{EN} range	–0.3 to +6.0	V
V _{OUT} range	–0.3 to +5.5	V
V _{NR} , V _{FB} range	–0.3 to +6.0	V
Peak output current	Internally limited	
Output short-circuit duration	Indefinite	
Continuous total power dissipation	See Thermal Information table	
Junction temperature range, T _J	–55 to +150	°C
Storage temperature range	–65 to +150	°C
ESD rating, HBM	2	kV
ESD rating, CDM	500	V

- (1) Stresses beyond those listed under *Absolute Maximum Ratings* may cause permanent damage to the device. These are stress ratings only, and functional operation of the device at these or any other conditions beyond those indicated under the *Electrical Characteristics* is not implied. Exposure to absolute maximum rated conditions for extended periods may affect device reliability.

THERMAL INFORMATION

THERMAL METRIC ⁽¹⁾		TPS73734 ⁽²⁾	UNITS
		DCQ ⁽³⁾	
		6 PINS	
θ_{JA}	Junction-to-ambient thermal resistance ⁽⁴⁾	70.4	°C/W
θ_{JcTop}	Junction-to-case (top) thermal resistance ⁽⁵⁾	70	
θ_{JB}	Junction-to-board thermal resistance ⁽⁶⁾	N/A	
ψ_{JT}	Junction-to-top characterization parameter ⁽⁷⁾	6.8	
ψ_{JB}	Junction-to-board characterization parameter ⁽⁸⁾	30.1	
θ_{JcBot}	Junction-to-case (bottom) thermal resistance ⁽⁹⁾	6.3	

(1) For more information about traditional and new thermal metrics, see the *IC Package Thermal Metrics* application report, [SPRA953A](#).

(2) Thermal data for the DRB, DCQ, and DRV packages are derived by thermal simulations based on JEDEC-standard methodology as specified in the JESD51 series. The following assumptions are used in the simulations:

(a) The exposed pad is connected to the PCB ground layer through a 3x2 thermal via array.

(b) Each of top and bottom copper layers has a dedicated pattern for 20% copper coverage.

(c) These data were generated with only a single device at the center of a JEDEC high-K (2s2p) board with 3in × 3in copper area. To understand the effects of the copper area on thermal performance, see the [Power Dissipation](#) and [Estimating Junction Temperature](#) sections of this data sheet.

(3) Power dissipation may limit operating range.

(4) The junction-to-ambient thermal resistance under natural convection is obtained in a simulation on a JEDEC-standard, high-K board, as specified in JESD51-7, in an environment described in JESD51-2a.

(5) The junction-to-case (top) thermal resistance is obtained by simulating a cold plate test on the top of the package. No specific JEDEC-standard test exists, but a close description can be found in the ANSI SEMI standard G30-88.

(6) The junction-to-board thermal resistance is obtained by simulating in an environment with a ring cold plate fixture to control the PCB temperature, as described in JESD51-8.

(7) The junction-to-top characterization parameter, ψ_{JT} , estimates the junction temperature of a device in a real system and is extracted from the simulation data to obtain θ_{JA} using a procedure described in JESD51-2a (sections 6 and 7).

(8) The junction-to-board characterization parameter, ψ_{JB} , estimates the junction temperature of a device in a real system and is extracted from the simulation data to obtain θ_{JA} using a procedure described in JESD51-2a (sections 6 and 7).

(9) The junction-to-case (bottom) thermal resistance is obtained by simulating a cold plate test on the exposed (power) pad. No specific JEDEC standard test exists, but a close description can be found in the ANSI SEMI standard G30-88.

ELECTRICAL CHARACTERISTICS

Over operating temperature range ($T_J = -40^\circ\text{C}$ to $+125^\circ\text{C}$), $V_{IN} = 4.4\text{V}$, $I_{OUT} = 10\text{mA}$, $V_{EN} = 2.2\text{V}$, and $C_{OUT} = 2.2\mu\text{F}$, unless otherwise noted. Typical values are at $T_J = +25^\circ\text{C}$.

PARAMETER		TEST CONDITIONS	TPS73734			UNIT
			MIN	TYP	MAX	
V_{IN}	Input voltage range		3.9		5.5	V
V_{OUT}	Accuracy	Nominal	$T_J = +25^\circ\text{C}$			%
		Over V_{IN} , I_{OUT} , and T	$V_{OUT} + 0.5\text{V} \leq V_{IN} \leq 5.5\text{V}$; $10\text{mA} \leq I_{OUT} \leq 1\text{A}$	-1.0	± 0.5	
$\Delta V_{OUT}\%/\Delta V_{IN}$	Line regulation	$V_{OUT(nom)} + 0.5\text{V} \leq V_{IN} \leq 5.5\text{V}$		0.01		%/V
$\Delta V_{OUT}\%/\Delta I_{OUT}$	Load regulation	$1\text{mA} \leq I_{OUT} \leq 1\text{A}$		0.002		%/mA
		$10\text{mA} \leq I_{OUT} \leq 1\text{A}$		0.0005		
V_{DO}	Dropout voltage ($V_{IN} = V_{OUT(nom)} - 0.1\text{V}$)	$I_{OUT} = 1\text{A}$		130	500	mV
$Z_O(\text{DO})$	Output impedance in dropout	$2.2\text{V} \leq V_{IN} \leq V_{OUT} + V_{DO}$		0.25		Ω
I_{CL}	Output current limit	$V_{OUT} = 0.9 \times V_{OUT(nom)}$	1.05	1.6	2.2	A
I_{SC}	Short-circuit current	$V_{OUT} = 0\text{V}$		450		mA
I_{REV}	Reverse leakage current ⁽¹⁾ ($-I_{IN}$)	$V_{EN} \leq 0.5\text{V}$, $0\text{V} \leq V_{IN} \leq V_{OUT}$		0.1		μA
I_{GND}	GND pin current	$I_{OUT} = 10\text{mA}$ (I_Q)		400		μA
		$I_{OUT} = 1\text{A}$		1300		
I_{SHDN}	Shutdown current (I_{GND})	$V_{EN} \leq 0.5\text{V}$, $V_{OUT} \leq V_{IN} \leq 5.5$		20		nA
PSRR	Power-supply rejection ratio (ripple rejection)	$f = 100\text{Hz}$, $I_{OUT} = 1\text{A}$		58		dB
		$f = 10\text{kHz}$, $I_{OUT} = 1\text{A}$		37		
V_N	Output noise voltage BW = 10Hz to 100kHz	$C_{OUT} = 10\mu\text{F}$		$27 \times V_{OUT}$		μV_{RMS}
t_{STR}	Startup time	$V_{OUT} = 3\text{V}$, $R_L = 30\Omega$, $C_{OUT} = 1\mu\text{F}$		600		μs
$V_{EN(HI)}$	EN pin high (enabled)		1.7		V_{IN}	V
$V_{EN(LO)}$	EN pin low (shutdown)		0		0.5	V
$I_{EN(HI)}$	EN pin current (enabled)	$V_{EN} = 5.5\text{V}$		20		nA
T_{SD}	Thermal shutdown temperature	Shutdown, temperature increasing		+160		$^\circ\text{C}$
		Reset, temperature decreasing		+140		
T_J	Operating junction temperature		-40		+125	$^\circ\text{C}$

(1) Fixed-voltage versions only; refer to the [Applications](#) section for more information.

FUNCTIONAL BLOCK DIAGRAM

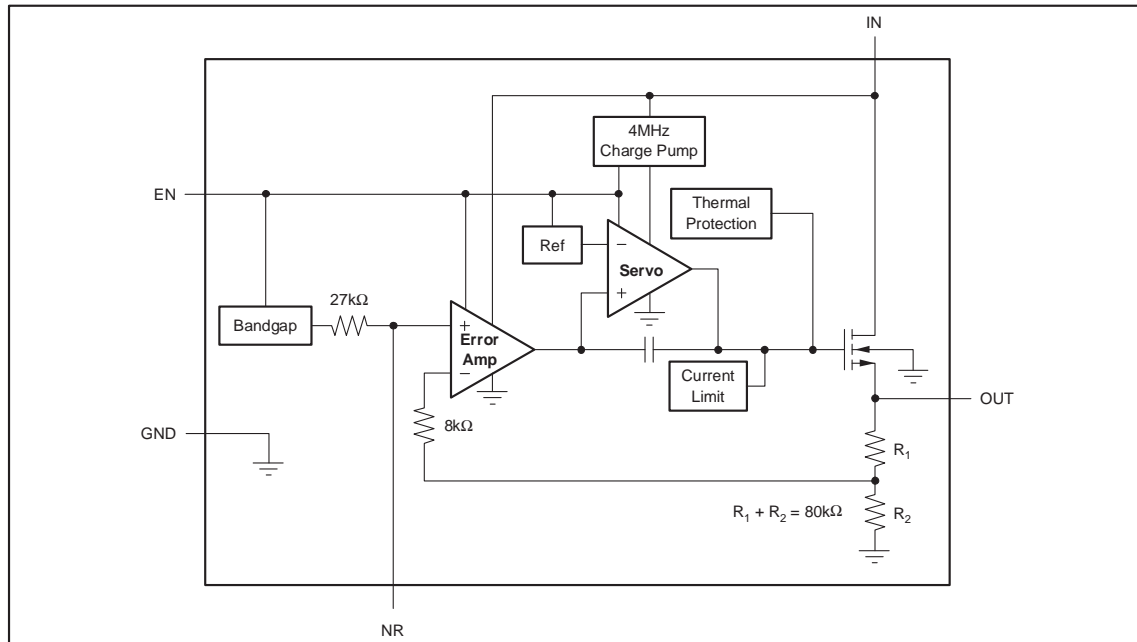

Figure 2. Fixed Voltage Version

PIN CONFIGURATION

DCQ PACKAGE
SOT223-6
(TOP VIEW)

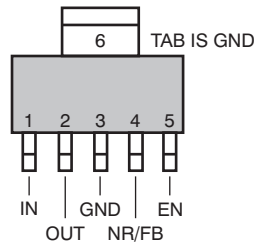

Table 1. Pin Descriptions

PIN NAME	SOT223 (DCQ) PIN NO.	DESCRIPTION
IN	1	Unregulated input supply
GND	3, 6	Ground
EN	5	Driving the enable pin (EN) high turns on the regulator. Driving this pin low puts the regulator into shutdown mode. Refer to the Shutdown section under Applications Information for more details. EN must not be left floating and can be connected to IN if not used.
NR	4	Fixed voltage versions only—connecting an external capacitor to this pin bypasses noise generated by the internal bandgap, reducing output noise to very low levels.
FB	4	Adjustable voltage version only—this is the input to the control loop error amplifier, and is used to set the output voltage of the device.
OUT	2	Regulator output. A 1.0μF or larger capacitor of any type is required for stability.
NC	—	Not connected

TYPICAL CHARACTERISTICS

For all voltage versions at $T_J = +25^\circ\text{C}$, $V_{IN} = 4.4\text{V}$, $I_{OUT} = 10\text{mA}$, $V_{EN} = 2.2\text{V}$, and $C_{OUT} = 2.2\mu\text{F}$, unless otherwise noted.

LOAD REGULATION

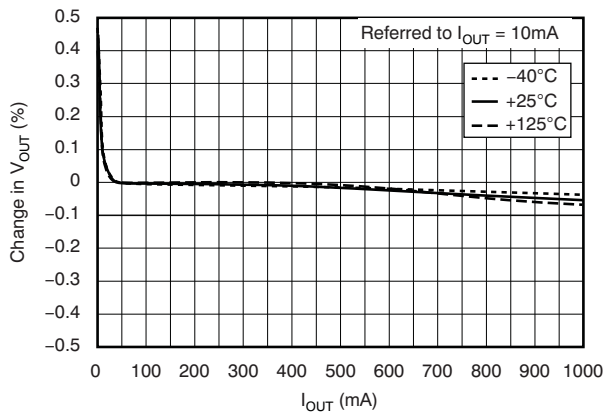

Figure 3.

LINE REGULATION

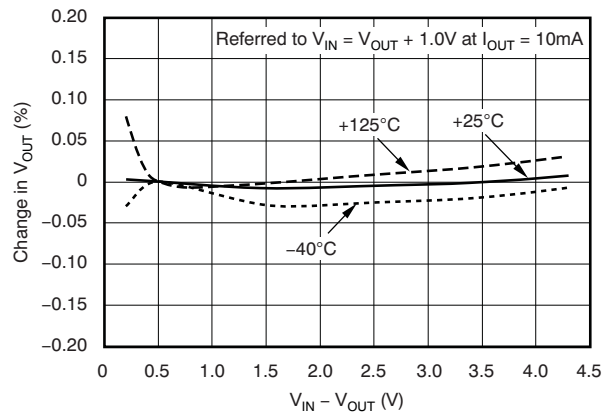

Figure 4.

DROPOUT VOLTAGE vs OUTPUT CURRENT

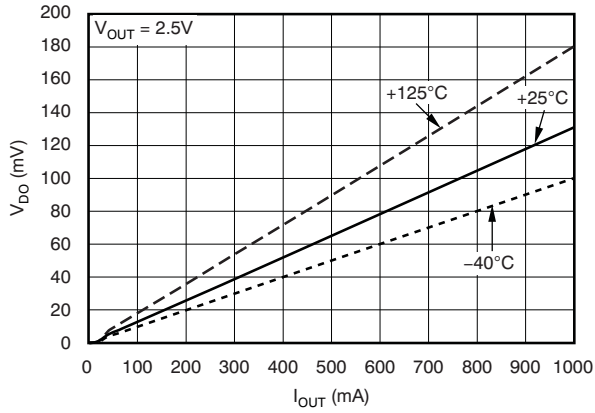

Figure 5.

DROPOUT VOLTAGE vs TEMPERATURE

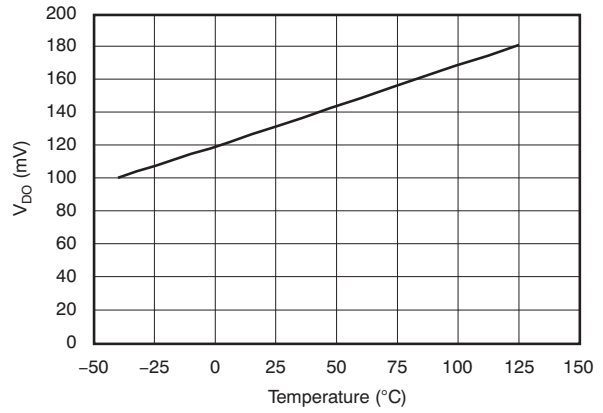

Figure 6.

OUTPUT VOLTAGE HISTOGRAM

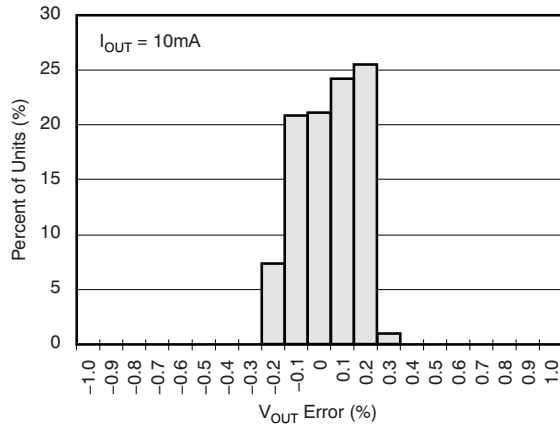

Figure 7.

DROPOUT VOLTAGE DRIFT HISTOGRAM

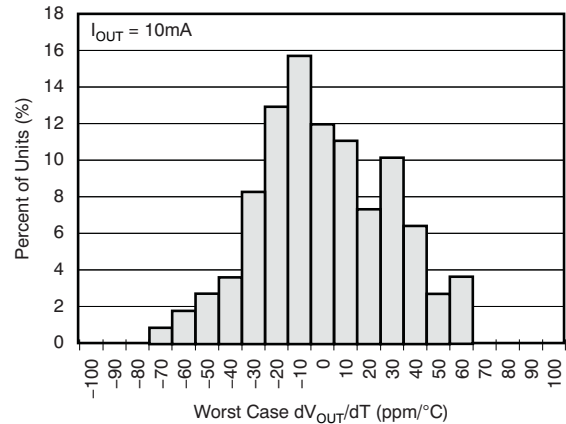

Figure 8.

TYPICAL CHARACTERISTICS (continued)

For all voltage versions at $T_J = +25^\circ\text{C}$, $V_{IN} = 4.4\text{V}$, $I_{OUT} = 10\text{mA}$, $V_{EN} = 2.2\text{V}$, and $C_{OUT} = 2.2\mu\text{F}$, unless otherwise noted.

GROUND PIN CURRENT vs OUTPUT CURRENT

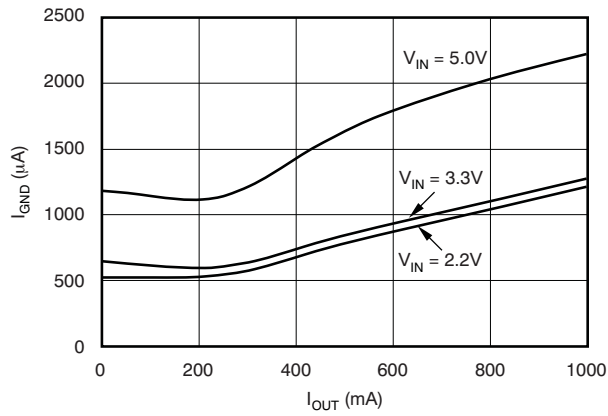

Figure 9.

GROUND PIN CURRENT vs TEMPERATURE

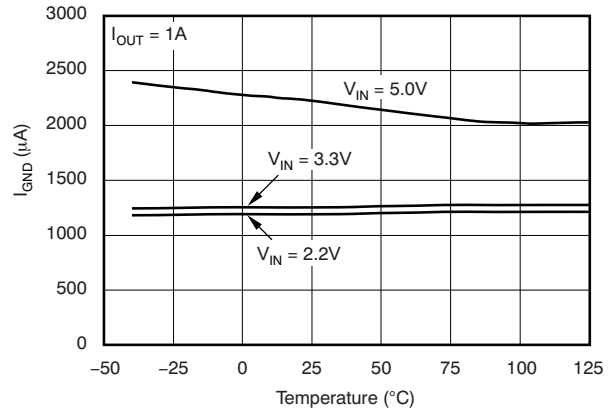

Figure 10.

GROUND PIN CURRENT IN SHUTDOWN vs TEMPERATURE

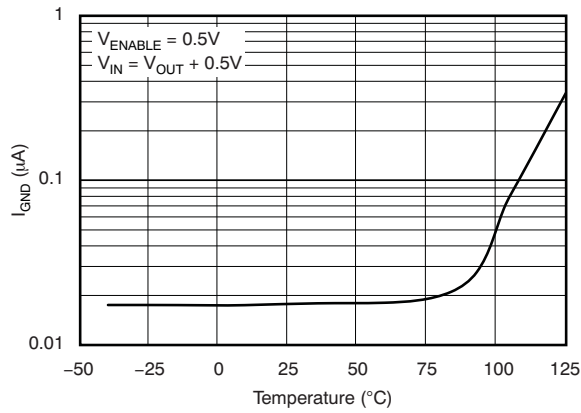

Figure 11.

CURRENT LIMIT vs V_{OUT} (FOLDBACK)

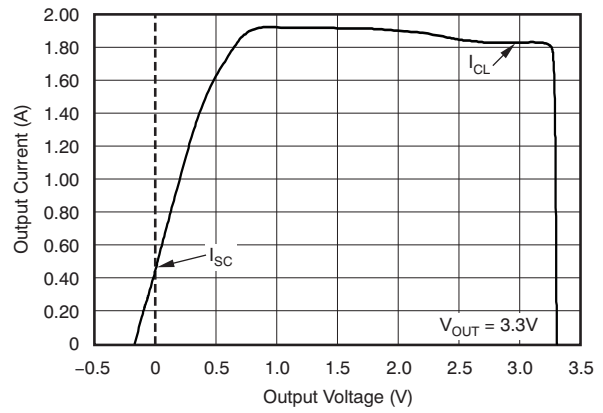

Figure 12.

CURRENT LIMIT vs V_{IN}

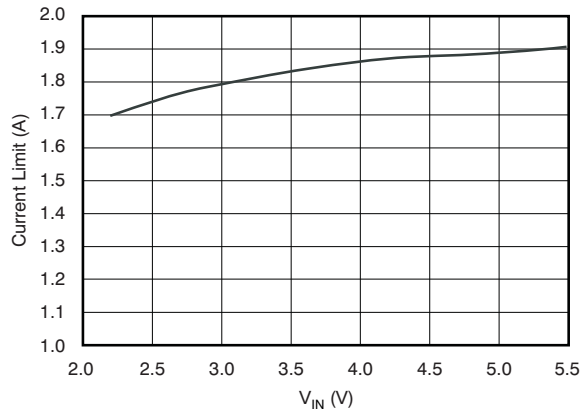

Figure 13.

CURRENT LIMIT vs TEMPERATURE

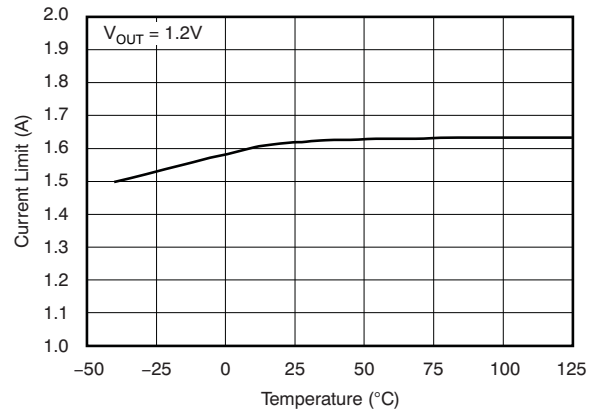

Figure 14.

TYPICAL CHARACTERISTICS (continued)

For all voltage versions at $T_J = +25^\circ\text{C}$, $V_{IN} = 4.4\text{V}$, $I_{OUT} = 10\text{mA}$, $V_{EN} = 2.2\text{V}$, and $C_{OUT} = 2.2\mu\text{F}$, unless otherwise noted.

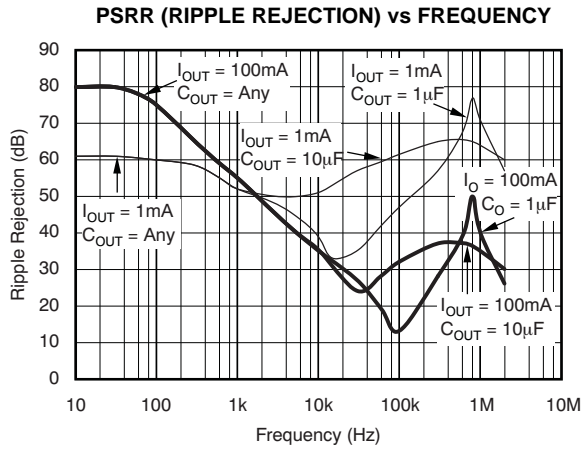

Figure 15.

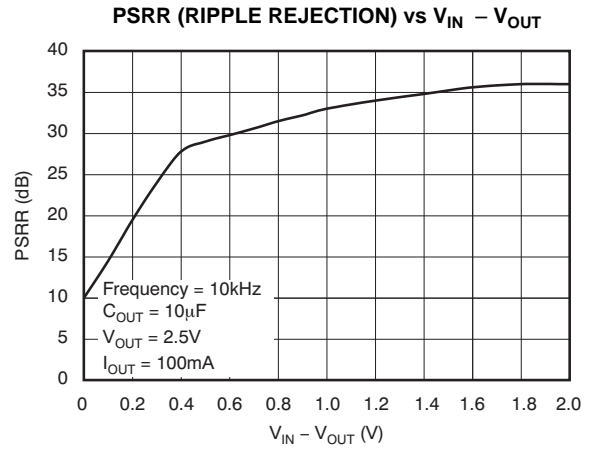

Figure 16.

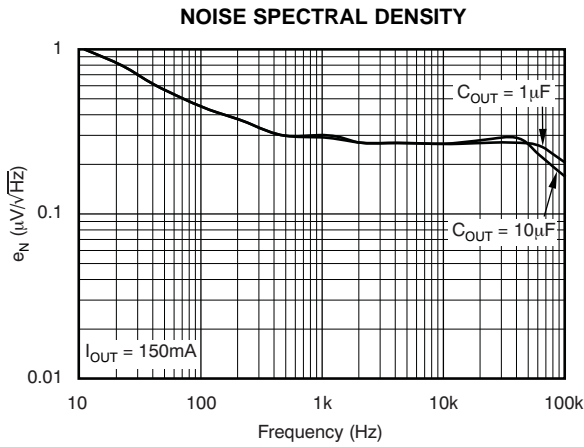

Figure 17.

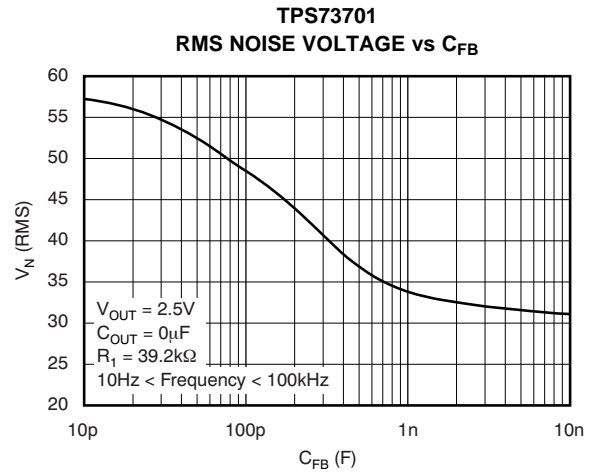

Figure 18.

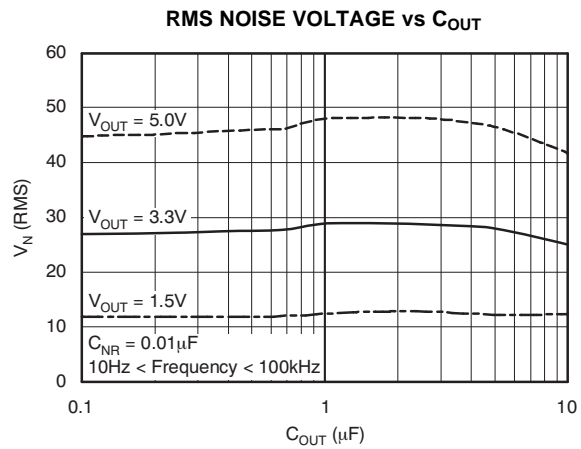

Figure 19.

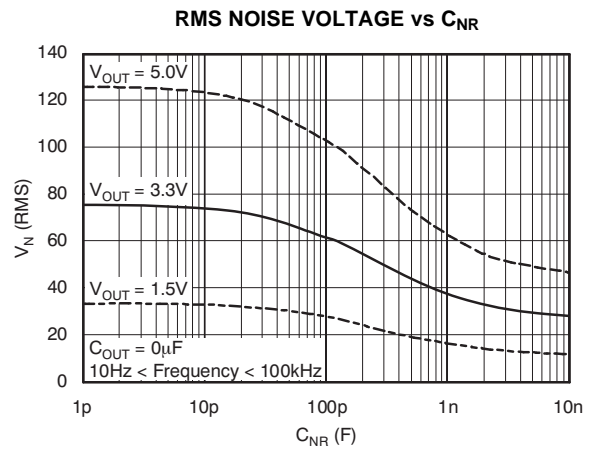

Figure 20.

TYPICAL CHARACTERISTICS (continued)

For all voltage versions at $T_J = +25^\circ\text{C}$, $V_{IN} = 4.4\text{V}$, $I_{OUT} = 10\text{mA}$, $V_{EN} = 2.2\text{V}$, and $C_{OUT} = 2.2\mu\text{F}$, unless otherwise noted.

**TPS73733
LOAD TRANSIENT RESPONSE**

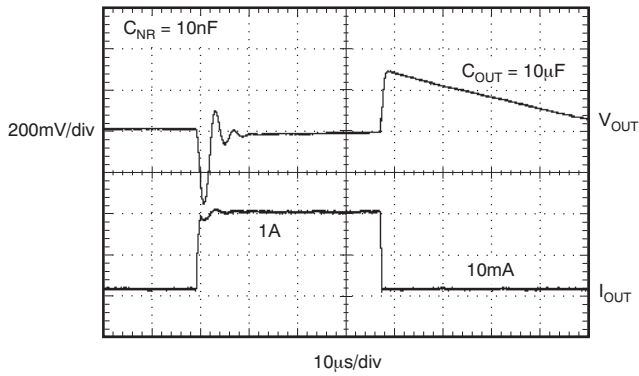

Figure 21.

**TPS73733
LINE TRANSIENT RESPONSE**

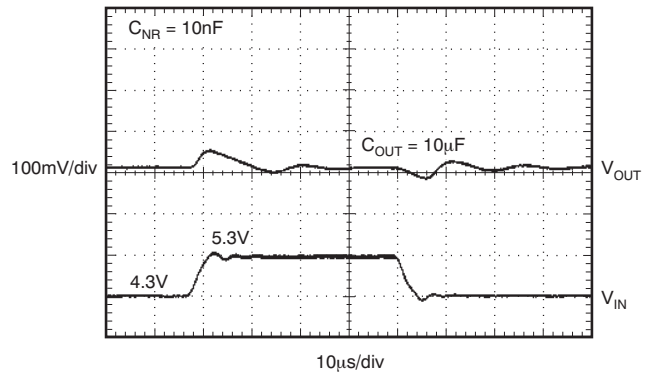

Figure 22.

**TPS73701
TURN-ON RESPONSE**

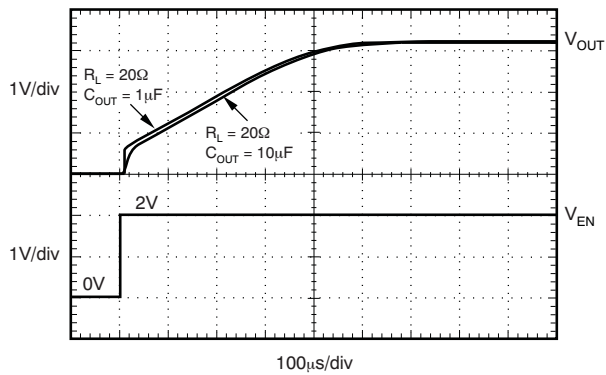

Figure 23.

**TPS73701
TURN-OFF RESPONSE**

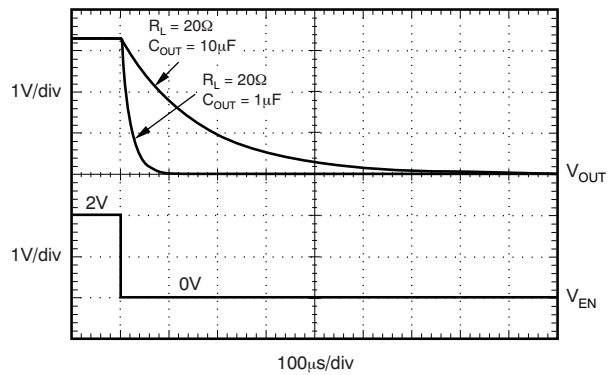

Figure 24.

**TPS73701, V_OUT = 3.3V
POWER-UP/POWER-DOWN**

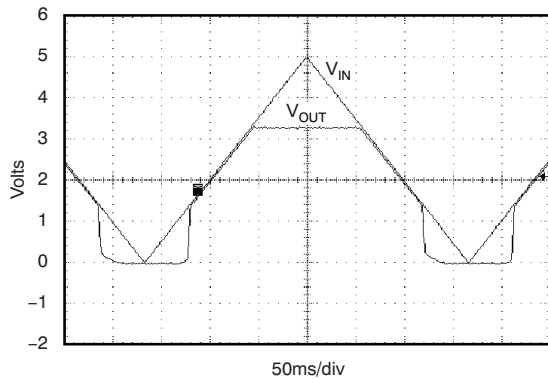

Figure 25.

I_ENABLE VS TEMPERATURE

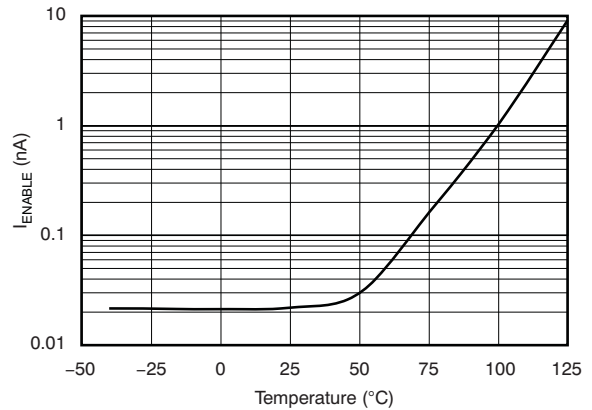

Figure 26.

TYPICAL CHARACTERISTICS (continued)

For all voltage versions at $T_J = +25^\circ\text{C}$, $V_{IN} = 4.4\text{V}$, $I_{OUT} = 10\text{mA}$, $V_{EN} = 2.2\text{V}$, and $C_{OUT} = 2.2\mu\text{F}$, unless otherwise noted.

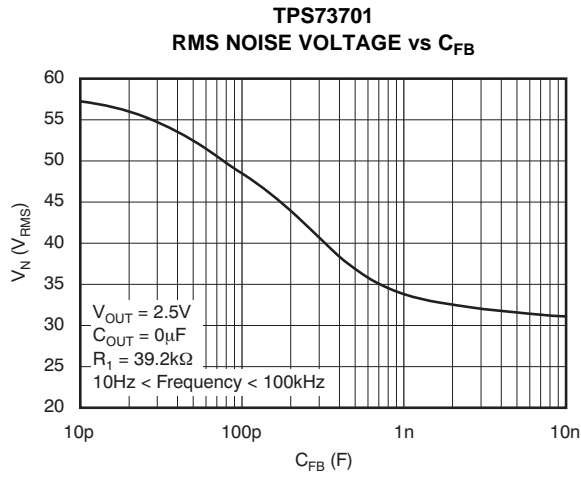

Figure 27.

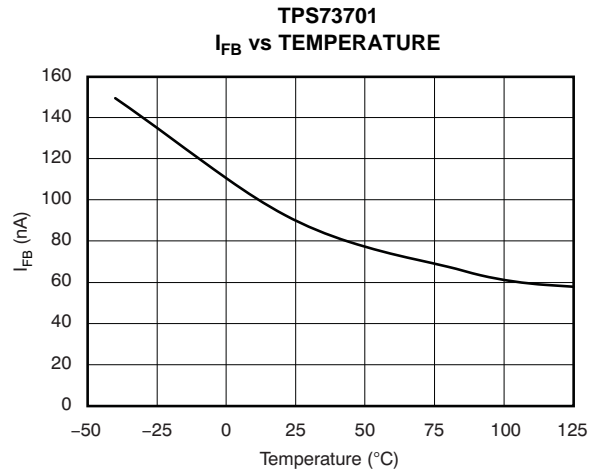

Figure 28.

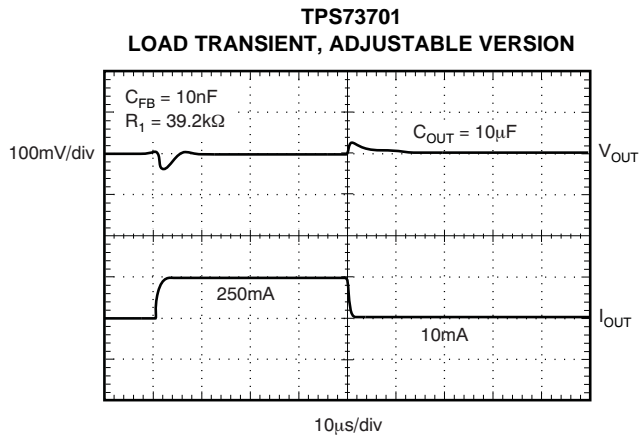

Figure 29.

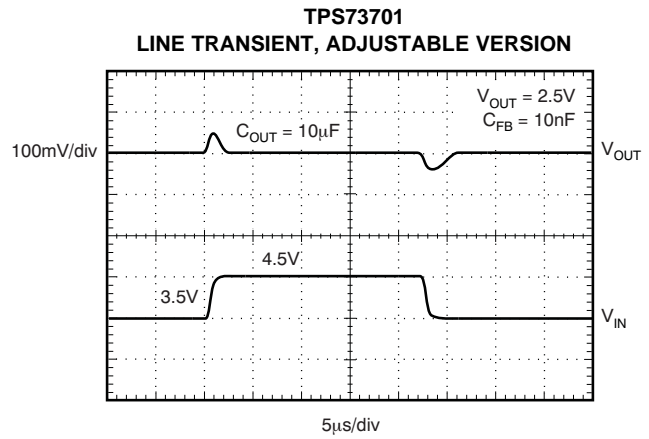

Figure 30.

APPLICATION INFORMATION

The TPS73734 belongs to a family of new generation LDO regulators that use an NMOS pass transistor to achieve ultra-low-dropout performance, reverse current blockage, and freedom from output capacitor constraints. These features combined with an enable input make the TPS73734 ideal for portable applications. This regulator offers a wide selection of fixed output voltage versions and an adjustable output version. All versions have thermal and over-current protection, including foldback current limit.

Figure 31 shows the basic circuit connections for the fixed voltage models.

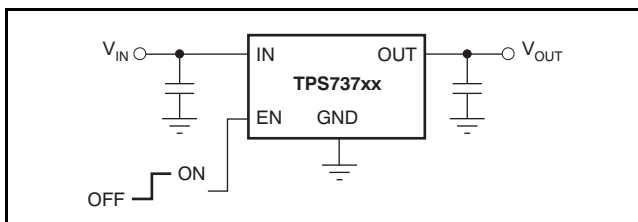

Figure 31. Typical Application Circuit for Fixed-Voltage Version

INPUT AND OUTPUT CAPACITOR REQUIREMENTS

Although an input capacitor is not required for stability if input impedance is very low, it is good analog design practice to connect a 0.1 μ F to 1 μ F low equivalent series resistance (ESR) capacitor across the input supply near the regulator. This capacitor counteracts reactive input sources and improves

transient response, noise rejection, and ripple rejection. A higher-value capacitor may be necessary if large, fast rise-time load transients are anticipated or the device is located several inches from the power source.

The TPS73734 requires a 1.0 μ F output capacitor for stability. It is designed to be stable for all available types and values of capacitors. In applications where multiple low ESR capacitors are in parallel, ringing may occur when the product of C_{OUT} and total ESR drops below 50n Ω F. Total ESR includes all parasitic resistances, including capacitor ESR and board, socket, and solder joint resistance. In most applications, the sum of capacitor ESR and trace resistance will meet this requirement.

OUTPUT NOISE

A precision bandgap reference is used to generate the internal reference voltage, V_{REF} . This reference is the dominant noise source within the TPS73734 and it generates approximately $32\mu V_{RMS}$ (10Hz to 100kHz) at the reference output (NR). The regulator control loop gains up the reference noise with the same gain as the reference voltage, so that the noise voltage of the regulator is approximately given by:

$$V_N = 32\mu V_{RMS} \times \frac{(R_1 + R_2)}{R_2} = 32\mu V_{RMS} \times \frac{V_{OUT}}{V_{REF}} \quad (1)$$

Since the value of V_{REF} is 1.2V, this relationship reduces to:

$$V_N(\mu V_{RMS}) = 27 \left(\frac{\mu V_{RMS}}{V} \right) \times V_{OUT} (V) \quad (2)$$

for the case of no C_{NR} .

An internal 27kΩ resistor in series with the noise reduction pin (NR) forms a low-pass filter for the voltage reference when an external noise reduction capacitor, C_{NR} , is connected from NR to ground. For $C_{NR} = 10\text{nF}$, the total noise in the 10Hz to 100kHz bandwidth is reduced by a factor of ~3.2, giving the approximate relationship:

$$V_N(\mu\text{V}_{\text{RMS}}) = 8.5 \left(\frac{\mu\text{V}_{\text{RMS}}}{\text{V}} \right) \times V_{\text{OUT}}(\text{V}) \quad (3)$$

for $C_{NR} = 10\text{nF}$.

This noise reduction effect is shown as RMS Noise Voltage vs C_{NR} in the [Typical Characteristics](#) section.

The TPS73734 uses an internal charge pump to develop an internal supply voltage sufficient to drive the gate of the NMOS pass element above V_{OUT} . The charge pump generates ~250μV of switching noise at ~4MHz; however, charge-pump noise contribution is negligible at the output of the regulator for most values of I_{OUT} and C_{OUT} .

BOARD LAYOUT RECOMMENDATION TO IMPROVE PSRR AND NOISE PERFORMANCE

To improve ac performance such as PSRR, output noise, and transient response, it is recommended that the printed circuit board (PCB) be designed with separate ground planes for V_{IN} and V_{OUT} , with each ground plane connected only at the GND pin of the device. In addition, the ground connection for the bypass capacitor should connect directly to the GND pin of the device.

INTERNAL CURRENT LIMIT

The TPS73734 internal current limit helps protect the regulator during fault conditions. Foldback current limit helps to protect the regulator from damage during output short-circuit conditions by reducing current limit when V_{OUT} drops below 0.5V. See [Figure 12](#) in the [Typical Characteristics](#) section.

Note from [Figure 12](#) that approximately –0.2V of V_{OUT} results in a current limit of 0mA. Therefore, if OUT is forced below –0.2V before EN goes high, the device may not start up. In applications that work with both a positive and negative voltage supply, the TPS73734 should be enabled first.

ENABLE PIN AND SHUTDOWN

The enable pin (EN) is active high and is compatible with standard TTL-CMOS levels. A V_{EN} below 0.5V (max) turns the regulator off and drops the GND pin current to approximately 10nA. When EN is used to shutdown the regulator, all charge is removed from the pass transistor gate, and the output ramps back up to a regulated V_{OUT} (see [Figure 23](#)).

When shutdown capability is not required, EN can be

connected to V_{IN} . However, the pass gate may not be discharged using this configuration, and the pass transistor may be left on (enhanced) for a significant time after V_{IN} has been removed. This scenario can result in reverse current flow (if the IN pin is low impedance) and faster ramp times upon power-up. In addition, for V_{IN} ramp times slower than a few milliseconds, the output may overshoot upon power-up.

Note that current limit foldback can prevent device start-up under some conditions. See the [Internal Current Limit](#) section for more information.

DROPOUT VOLTAGE

The TPS73734 uses an NMOS pass transistor to achieve extremely low dropout. When $(V_{\text{IN}} - V_{\text{OUT}})$ is less than the dropout voltage (V_{DO}), the NMOS pass device is in its linear region of operation and the input-to-output resistance is the $R_{\text{DS, ON}}$ of the NMOS pass element.

For large step changes in load current, the TPS73734 requires a larger voltage drop from V_{IN} to V_{OUT} to avoid degraded transient response. The boundary of this transient dropout region is approximately twice the dc dropout. Values of $V_{\text{IN}} - V_{\text{OUT}}$ above this line ensure normal transient response.

Operating in the transient dropout region can cause an increase in recovery time. The time required to recover from a load transient is a function of the magnitude of the change in load current rate, the rate of change in load current, and the available headroom (V_{IN} to V_{OUT} voltage drop). Under worst-case conditions [full-scale instantaneous load change with $(V_{\text{IN}} - V_{\text{OUT}})$ close to dc dropout levels], the TPS73734 can take a couple of hundred microseconds to return to the specified regulation accuracy.

TRANSIENT RESPONSE

The low open-loop output impedance provided by the NMOS pass element in a voltage follower configuration allows operation without a 1.0μF output capacitor. As with any regulator, the addition of additional capacitance from the OUT pin to ground reduces undershoot magnitude but increases its duration. In the adjustable version, the addition of a capacitor, C_{FB} , from the OUT pin to the FB pin will also improve the transient response.

The TPS73734 does not have active pull-down when the output is over-voltage. This architecture allows applications that connect higher voltage sources, such as alternate power supplies, to the output. This architecture also results in an output overshoot of several percent if the load current quickly drops to zero when a capacitor is connected to the output. The

duration of overshoot can be reduced by adding a load resistor. The overshoot decays at a rate determined by output capacitor C_{OUT} and the internal/external load resistance. The rate of decay is given by:

$$\frac{dV}{dT} = \frac{V_{OUT}}{C_{OUT} \times 80k\Omega \parallel R_{LOAD}} \quad (4)$$

REVERSE CURRENT

The NMOS pass element of the TPS73734 provides inherent protection against current flow from the output of the regulator to the input when the gate of the pass device is pulled low. To ensure that all charge is removed from the gate of the pass element, the EN pin must be driven low before the input voltage is removed. If this is not done, the pass element may be left on because of stored charge on the gate.

After the EN pin is driven low, no bias voltage is needed on any pin for reverse current blocking. Note that reverse current is specified as the current flowing out of the IN pin because of voltage applied on the OUT pin. There will be additional current flowing into the OUT pin as a result of the 80k Ω internal resistor divider to ground (see [Figure 2](#)).

THERMAL PROTECTION

Thermal protection disables the output when the junction temperature rises to approximately +160°C, allowing the device to cool. When the junction temperature cools to approximately +140°C, the output circuitry is again enabled. Depending on power dissipation, thermal resistance, and ambient temperature, the thermal protection circuit may cycle on and off. This cycling limits the dissipation of the regulator, protecting it from damage due to overheating.

Any tendency to activate the thermal protection circuit indicates excessive power dissipation or an inadequate heatsink. For reliable operation, junction temperature should be limited to +125°C maximum. To estimate the margin of safety in a complete design (including heatsink), increase the ambient temperature until the thermal protection is triggered; use worst-case loads and signal conditions. For good reliability, thermal protection should trigger at least +35°C above the maximum expected ambient condition of your application. This produces a worst-case junction temperature of +125°C at the highest expected ambient temperature and worst-case load.

The internal protection circuitry of the TPS73734 has been designed to protect against overload conditions. It was not intended to replace proper heatsinking. Continuously running the TPS73734 into thermal shutdown degrades device reliability.

POWER DISSIPATION

Knowing the device power dissipation and proper sizing of the thermal plane that is connected to the tab or pad is critical to avoiding thermal shutdown and ensuring reliable operation.

Power dissipation of the device depends on input voltage and load conditions and can be calculated using Equation 5:

$$P_D = (V_{IN} - V_{OUT}) \times I_{OUT} \quad (5)$$

Power dissipation can be minimized and greater efficiency can be achieved by using the lowest possible input voltage necessary to achieve the required output voltage regulation.

On both SON (DRB) and SON (DRV) packages, the primary conduction path for heat is through the exposed pad to the printed circuit board (PCB). The pad can be connected to ground or be left floating; however, it should be attached to an appropriate amount of copper PCB area to ensure the device does not overheat. On the SOT-223 (DCQ) package, the primary conduction path for heat is through the tab to the PCB. That tab should be connected to ground. The maximum junction-to-ambient thermal resistance depends on the maximum ambient temperature, maximum device junction temperature, and power dissipation of the device and can be calculated using Equation 6:

$$R_{\theta JA} = \frac{(+125^{\circ}\text{C} - T_A)}{P_D} \quad (6)$$

Knowing the maximum $R_{\theta JA}$, the minimum amount of PCB copper area needed for appropriate heatsinking can be estimated using Figure 32.

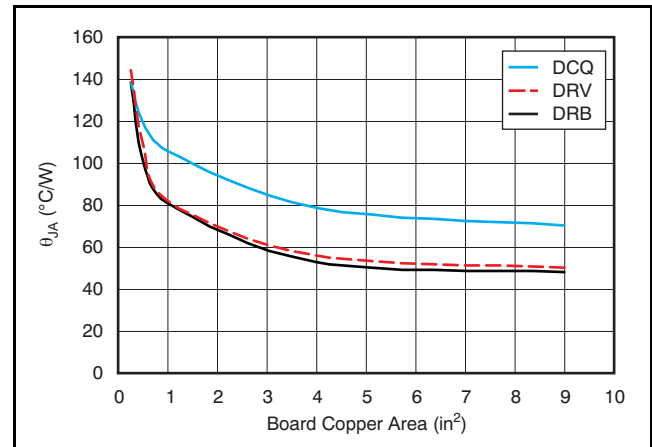

Note: θ_{JA} value at board size of 9in² (that is, 3in × 3in) is a JEDEC standard.

Figure 32. θ_{JA} vs Board Size

Figure 32 shows the variation of θ_{JA} as a function of ground plane copper area in the board. It is intended only as a guideline to demonstrate the effects of heat spreading in the ground plane and should not be used to estimate actual thermal performance in real application environments.

NOTE: When the device is mounted on an application PCB, it is strongly recommended to use Ψ_{JT} and Ψ_{JB} , as explained in the [Estimating Junction Temperature](#) section.

ESTIMATING JUNCTION TEMPERATURE

Using the thermal metrics Ψ_{JT} and Ψ_{JB} , as shown in the [Thermal Information](#) table, the junction temperature can be estimated with corresponding formulas (given in [Equation 7](#)). For backwards compatibility, an older $\theta_{JC,Top}$ parameter is listed as well.

$$\Psi_{JT}: T_J = T_T + \Psi_{JT} \cdot P_D$$

$$\Psi_{JB}: T_J = T_B + \Psi_{JB} \cdot P_D \quad (7)$$

Where P_D is the power dissipation shown by [Equation 5](#), T_T is the temperature at the center-top of the IC package, and T_B is the PCB temperature measured 1mm away from the IC package *on the PCB surface* (as [Figure 34](#) shows).

NOTE: Both T_T and T_B can be measured on actual application boards using a thermo-gun (an infrared thermometer).

For more information about measuring T_T and T_B , see the application note [SBVA025, Using New Thermal Metrics](#), available for download at [www.ti.com](#).

By looking at [Figure 33](#), the new thermal metrics (Ψ_{JT} and Ψ_{JB}) have very little dependency on board size. That is, using Ψ_{JT} or Ψ_{JB} with [Equation 7](#) is a good way to estimate T_J by simply measuring T_T or T_B , regardless of the application board size.

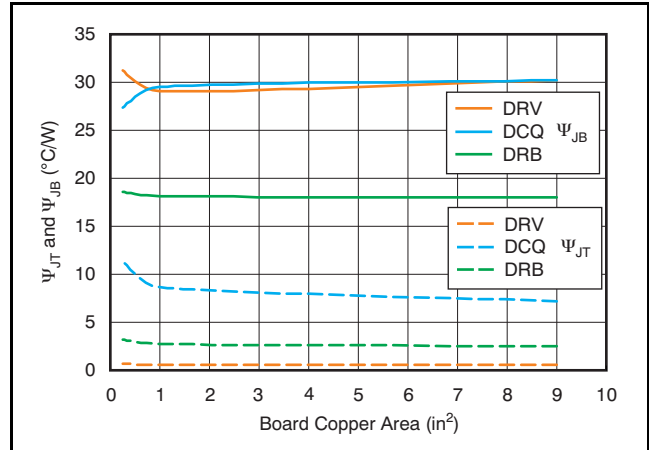
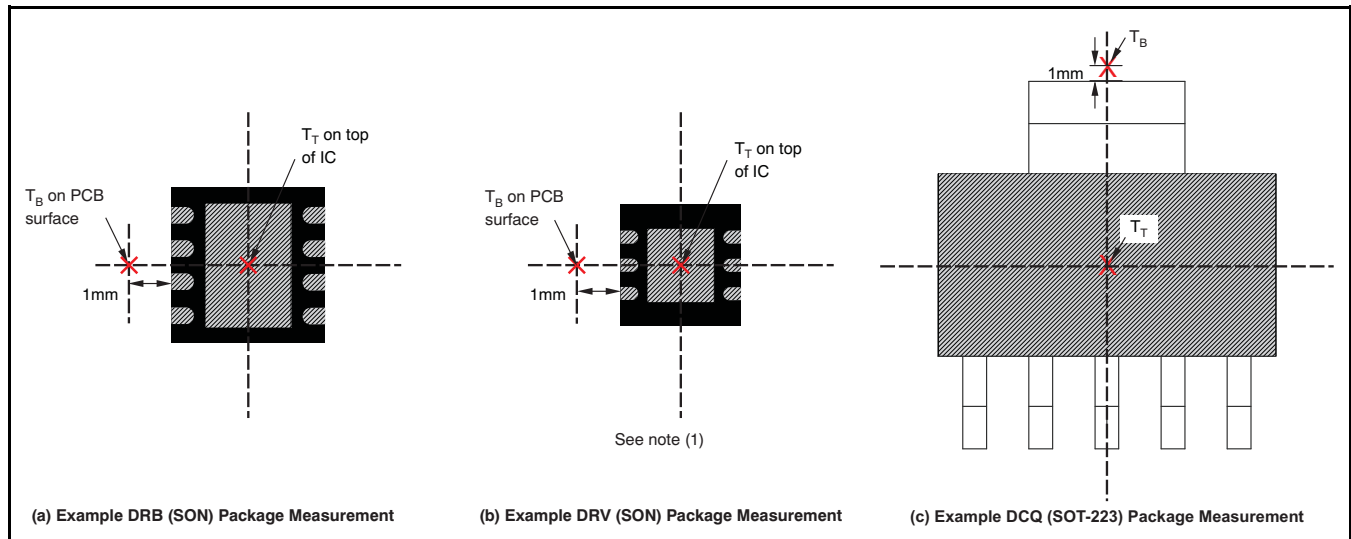

Figure 33. Ψ_{JT} and Ψ_{JB} vs Board Size

For a more detailed discussion of why TI does not recommend using $\theta_{JC(top)}$ to determine thermal characteristics, refer to application report [SBVA025, Using New Thermal Metrics](#), available for download at [www.ti.com](#). For further information, refer to application report [SPRA953, IC Package Thermal Metrics](#), also available on the TI website.



(1) Power dissipation may limit operating range. Check [Thermal Information](#) table.

Figure 34. Measuring Points for T_T and T_B

PACKAGING INFORMATION

Orderable Device	Status ⁽¹⁾	Package Type	Package Drawing	Pins	Package Qty	Eco Plan ⁽²⁾	Lead/ Ball Finish	MSL Peak Temp ⁽³⁾	Samples (Requires Login)
TPS73734DCQ	ACTIVE	SOT-223	DCQ	6	78	Green (RoHS & no Sb/Br)	CU NIPDAU	Level-2-260C-1 YEAR	
TPS73734DCQR	ACTIVE	SOT-223	DCQ	6	2500	Green (RoHS & no Sb/Br)	CU NIPDAU	Level-2-260C-1 YEAR	

⁽¹⁾ The marketing status values are defined as follows:

ACTIVE: Product device recommended for new designs.

LIFEBUY: TI has announced that the device will be discontinued, and a lifetime-buy period is in effect.

NRND: Not recommended for new designs. Device is in production to support existing customers, but TI does not recommend using this part in a new design.

PREVIEW: Device has been announced but is not in production. Samples may or may not be available.

OBsolete: TI has discontinued the production of the device.

⁽²⁾ Eco Plan - The planned eco-friendly classification: Pb-Free (RoHS), Pb-Free (RoHS Exempt), or Green (RoHS & no Sb/Br) - please check <http://www.ti.com/productcontent> for the latest availability information and additional product content details.

TBD: The Pb-Free/Green conversion plan has not been defined.

Pb-Free (RoHS): TI's terms "Lead-Free" or "Pb-Free" mean semiconductor products that are compatible with the current RoHS requirements for all 6 substances, including the requirement that lead not exceed 0.1% by weight in homogeneous materials. Where designed to be soldered at high temperatures, TI Pb-Free products are suitable for use in specified lead-free processes.

Pb-Free (RoHS Exempt): This component has a RoHS exemption for either 1) lead-based flip-chip solder bumps used between the die and package, or 2) lead-based die adhesive used between the die and leadframe. The component is otherwise considered Pb-Free (RoHS compatible) as defined above.

Green (RoHS & no Sb/Br): TI defines "Green" to mean Pb-Free (RoHS compatible), and free of Bromine (Br) and Antimony (Sb) based flame retardants (Br or Sb do not exceed 0.1% by weight in homogeneous material)

⁽³⁾ MSL, Peak Temp. -- The Moisture Sensitivity Level rating according to the JEDEC industry standard classifications, and peak solder temperature.

Important Information and Disclaimer: The information provided on this page represents TI's knowledge and belief as of the date that it is provided. TI bases its knowledge and belief on information provided by third parties, and makes no representation or warranty as to the accuracy of such information. Efforts are underway to better integrate information from third parties. TI has taken and continues to take reasonable steps to provide representative and accurate information but may not have conducted destructive testing or chemical analysis on incoming materials and chemicals. TI and TI suppliers consider certain information to be proprietary, and thus CAS numbers and other limited information may not be available for release.

In no event shall TI's liability arising out of such information exceed the total purchase price of the TI part(s) at issue in this document sold by TI to Customer on an annual basis.

TAPE AND REEL INFORMATION

QUADRANT ASSIGNMENTS FOR PIN 1 ORIENTATION IN TAPE

*All dimensions are nominal

Device	Package Type	Package Drawing	Pins	SPQ	Reel Diameter (mm)	Reel Width W1 (mm)	A0 (mm)	B0 (mm)	K0 (mm)	P1 (mm)	W (mm)	Pin1 Quadrant
TPS73734DCQR	SOT-223	DCQ	6	2500	330.0	12.4	6.8	7.3	1.88	8.0	12.0	Q3

TAPE AND REEL BOX DIMENSIONS



*All dimensions are nominal

Device	Package Type	Package Drawing	Pins	SPQ	Length (mm)	Width (mm)	Height (mm)
TPS73734DCQR	SOT-223	DCQ	6	2500	358.0	335.0	35.0

DCQ (R-PDSO-G6)

PLASTIC SMALL-OUTLINE

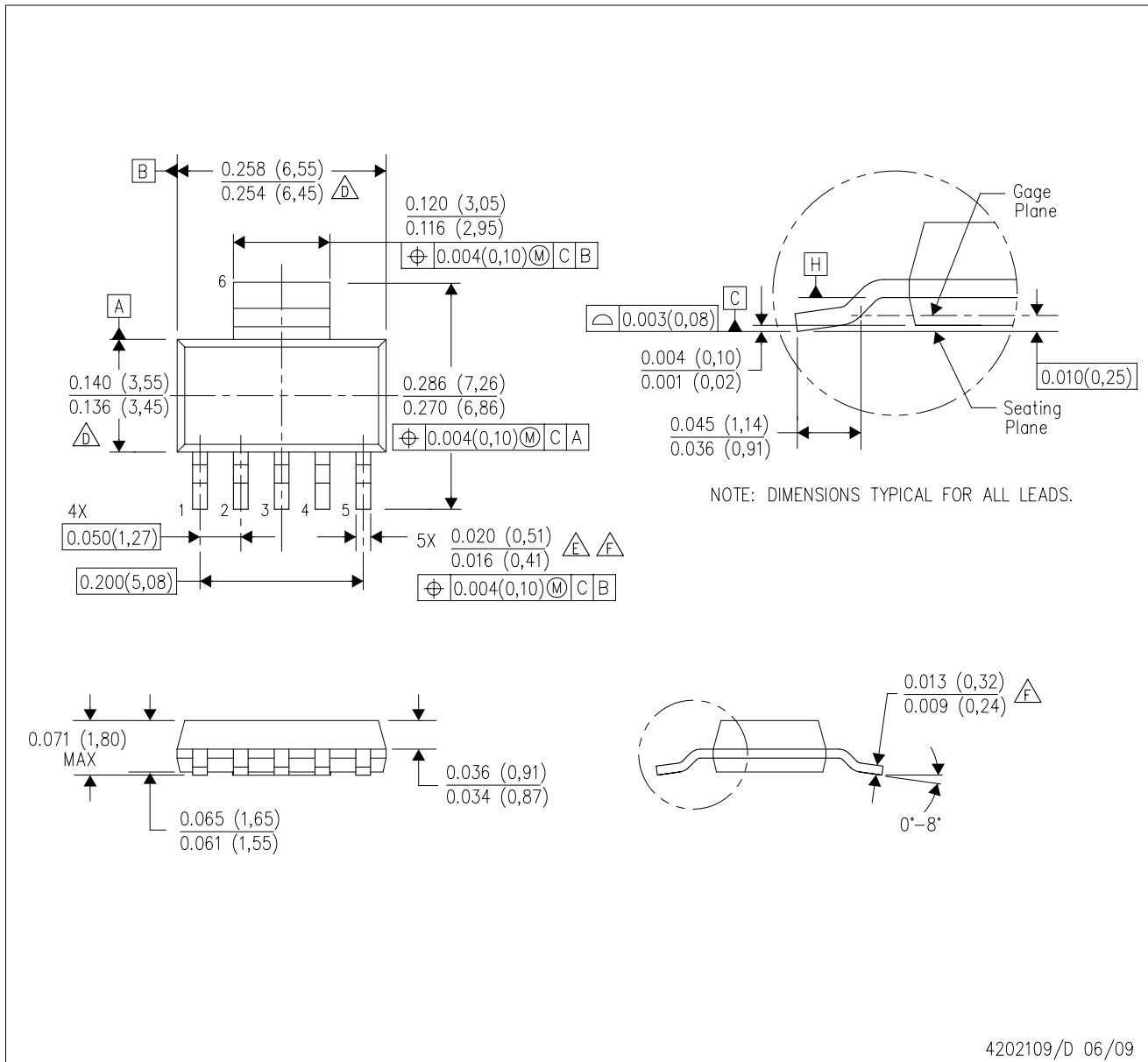

4202109/D 06/09

- NOTES:
- A. All linear dimensions are in inches (millimeters).
 - B. This drawing is subject to change without notice.
 - C. Controlling dimension in inches.
 - $\triangle D$ Body length and width dimensions are determined at the outermost extremes of the plastic body exclusive of mold flash, tie bar burrs, gate burrs, and interlead flash, but including any mismatch between the top and the bottom of the plastic body.
 - $\triangle E$ Lead width dimension does not include dambar protrusion.
 - $\triangle F$ Lead width and thickness dimensions apply to solder plated leads.
 - G. Interlead flash allow 0.008 inch max.
 - H. Gate burr/protrusion max. 0.006 inch.
 - I. Datums A and B are to be determined at Datum H.

DCQ (R-PDSO-G6)

PLASTIC SMALL OUTLINE

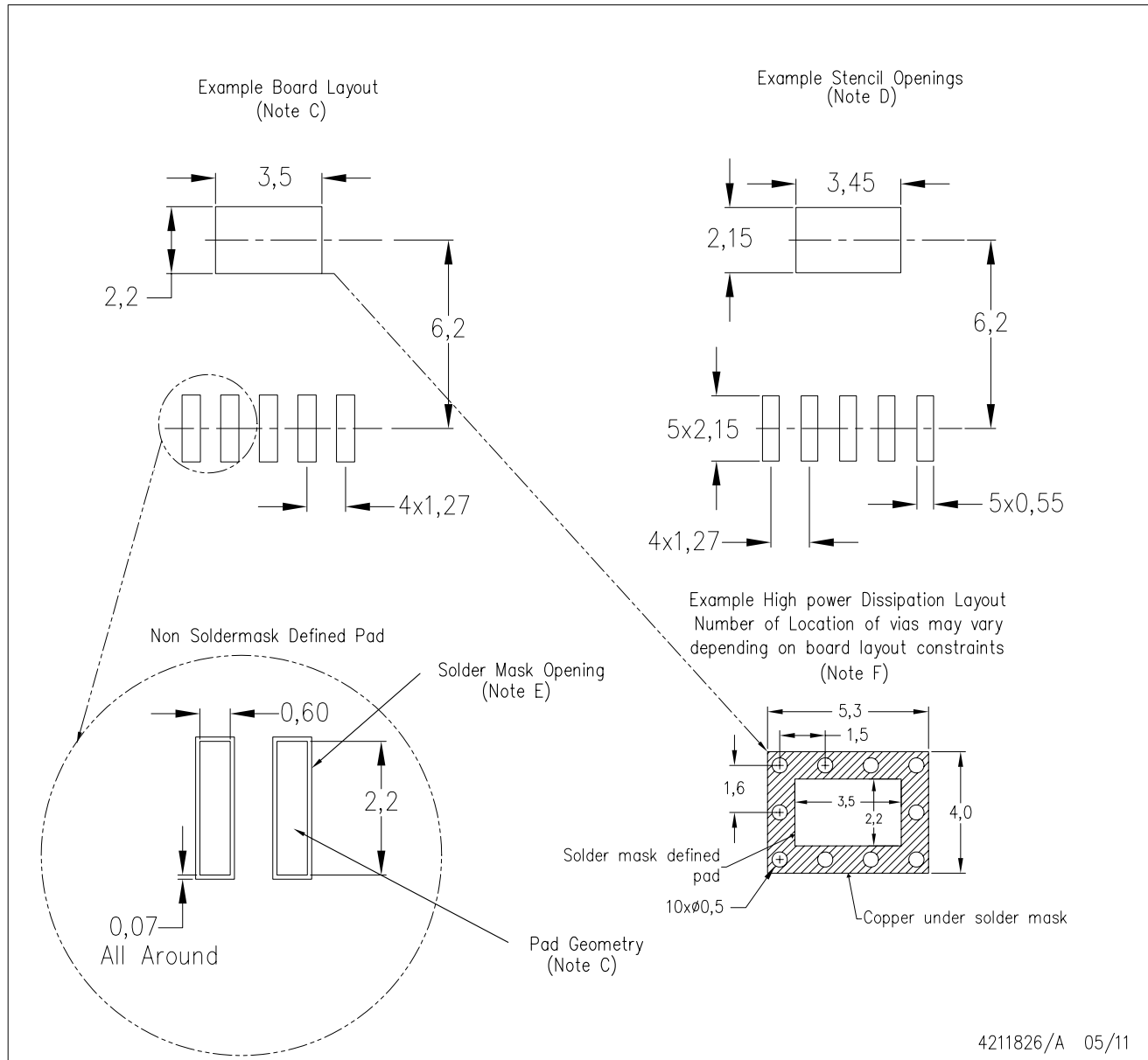

- NOTES:
- All linear dimensions are in millimeters.
 - This drawing is subject to change without notice.
 - Publication IPC-SM-782 is recommended for alternate designs.
 - Laser cutting apertures with trapezoidal walls and also rounding corners will offer better paste release. Customers should contact their board assembly site for stencil design recommendations.
 - Customers should contact their board fabrication site for solder mask tolerances between and around signal pads.
 - Please refer to the product data sheet for specific via and thermal dissipation requirements.

IMPORTANT NOTICE

Texas Instruments Incorporated and its subsidiaries (TI) reserve the right to make corrections, modifications, enhancements, improvements, and other changes to its products and services at any time and to discontinue any product or service without notice. Customers should obtain the latest relevant information before placing orders and should verify that such information is current and complete. All products are sold subject to TI's terms and conditions of sale supplied at the time of order acknowledgment.

TI warrants performance of its hardware products to the specifications applicable at the time of sale in accordance with TI's standard warranty. Testing and other quality control techniques are used to the extent TI deems necessary to support this warranty. Except where mandated by government requirements, testing of all parameters of each product is not necessarily performed.

TI assumes no liability for applications assistance or customer product design. Customers are responsible for their products and applications using TI components. To minimize the risks associated with customer products and applications, customers should provide adequate design and operating safeguards.

TI does not warrant or represent that any license, either express or implied, is granted under any TI patent right, copyright, mask work right, or other TI intellectual property right relating to any combination, machine, or process in which TI products or services are used. Information published by TI regarding third-party products or services does not constitute a license from TI to use such products or services or a warranty or endorsement thereof. Use of such information may require a license from a third party under the patents or other intellectual property of the third party, or a license from TI under the patents or other intellectual property of TI.

Reproduction of TI information in TI data books or data sheets is permissible only if reproduction is without alteration and is accompanied by all associated warranties, conditions, limitations, and notices. Reproduction of this information with alteration is an unfair and deceptive business practice. TI is not responsible or liable for such altered documentation. Information of third parties may be subject to additional restrictions.

Resale of TI products or services with statements different from or beyond the parameters stated by TI for that product or service voids all express and any implied warranties for the associated TI product or service and is an unfair and deceptive business practice. TI is not responsible or liable for any such statements.

TI products are not authorized for use in safety-critical applications (such as life support) where a failure of the TI product would reasonably be expected to cause severe personal injury or death, unless officers of the parties have executed an agreement specifically governing such use. Buyers represent that they have all necessary expertise in the safety and regulatory ramifications of their applications, and acknowledge and agree that they are solely responsible for all legal, regulatory and safety-related requirements concerning their products and any use of TI products in such safety-critical applications, notwithstanding any applications-related information or support that may be provided by TI. Further, Buyers must fully indemnify TI and its representatives against any damages arising out of the use of TI products in such safety-critical applications.

TI products are neither designed nor intended for use in military/aerospace applications or environments unless the TI products are specifically designated by TI as military-grade or "enhanced plastic." Only products designated by TI as military-grade meet military specifications. Buyers acknowledge and agree that any such use of TI products which TI has not designated as military-grade is solely at the Buyer's risk, and that they are solely responsible for compliance with all legal and regulatory requirements in connection with such use.

TI products are neither designed nor intended for use in automotive applications or environments unless the specific TI products are designated by TI as compliant with ISO/TS 16949 requirements. Buyers acknowledge and agree that, if they use any non-designated products in automotive applications, TI will not be responsible for any failure to meet such requirements.

Following are URLs where you can obtain information on other Texas Instruments products and application solutions:

Products

Audio	www.ti.com/audio
Amplifiers	amplifier.ti.com
Data Converters	dataconverter.ti.com
DLP® Products	www.dlp.com
DSP	dsp.ti.com
Clocks and Timers	www.ti.com/clocks
Interface	interface.ti.com
Logic	logic.ti.com
Power Mgmt	power.ti.com
Microcontrollers	microcontroller.ti.com
RFID	www.ti-rfid.com
RF/IF and ZigBee® Solutions	www.ti.com/lprf

Applications

Communications and Telecom	www.ti.com/communications
Computers and Peripherals	www.ti.com/computers
Consumer Electronics	www.ti.com/consumer-apps
Energy and Lighting	www.ti.com/energy
Industrial	www.ti.com/industrial
Medical	www.ti.com/medical
Security	www.ti.com/security
Space, Avionics and Defense	www.ti.com/space-avionics-defense
Transportation and Automotive	www.ti.com/automotive
Video and Imaging	www.ti.com/video
Wireless	www.ti.com/wireless-apps

TI E2E Community Home Page

e2e.ti.com

Mailing Address: Texas Instruments, Post Office Box 655303, Dallas, Texas 75265
Copyright © 2011, Texas Instruments Incorporated