

SN54BCT2828A, SN74BCT2828B 10-BIT BUS/MOS MEMORY DRIVERS WITH 3-STATE OUTPUTS

SCBS058A – APRIL 1987 – REVISED NOVEMBER 1993

- State-of-the-Art BiCMOS Design Significantly Reduces I_{CCZ}
- ESD Protection Exceeds 2000 V Per MIL-STD-883C, Method 3015
- Output Ports Have Equivalent 33- Ω Series Resistors, So No External Resistors Are Required
- 3-State Inverting Outputs Drive Bus Lines or Buffer Memory Address Registers
- Flow-Through Architecture Optimizes PCB Layout
- Package Options Include Plastic Small-Outline (DW) Packages, Ceramic Chip Carriers (FK) and Flatpacks, and Standard Plastic and Ceramic 300-mil DIPs (JT, NT)

SN54BCT2828A . . . JT OR W PACKAGE
SN74BCT2828B . . . DW OR NT PACKAGE
(TOP VIEW)

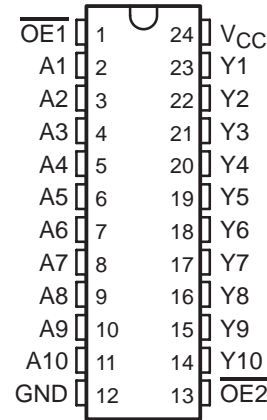

SN54BCT2828A . . . FK PACKAGE
(TOP VIEW)

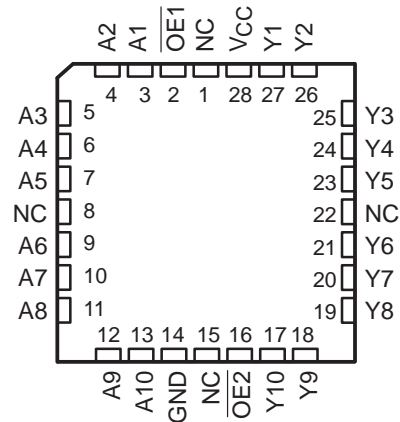

NC – No internal connection

description

These 10-bit bus/MOS memory drivers provide a high-performance bus interface for wide data paths or buses carrying parity.

The 3-state control gate is a 2-input AND gate with active-low inputs so that if either output-enable ($\overline{OE1}$ or $\overline{OE2}$) input is high, all ten outputs are in the high-impedance state. The outputs are also in the high-impedance state during power-up and power-down conditions. The outputs remain in the high-impedance state while the device is powered down.

The outputs, which are designed to source or sink up to 12 mA, include 33- Ω series resistors to reduce overshoot and undershoot.

The SN54BCT2828A is characterized for operation over the full military temperature range of -55°C to 125°C . The SN74BCT2828B is characterized for operation from 0°C to 70°C .

FUNCTION TABLE

INPUTS			OUTPUT
$\overline{OE1}$	$\overline{OE2}$	A	Y
L	L	L	H
L	L	H	L
H	X	X	Z
X	H	X	Z

PRODUCTION DATA information is current as of publication date. Products conform to specifications per the terms of Texas Instruments standard warranty. Production processing does not necessarily include testing of all parameters.

 **TEXAS
INSTRUMENTS**

POST OFFICE BOX 655303 • DALLAS, TEXAS 75265
POST OFFICE BOX 1443 • HOUSTON, TEXAS 77251-1443

Copyright © 1993, Texas Instruments Incorporated

SN54BCT2828A, SN74BCT2828B 10-BIT BUS/MOS MEMORY DRIVERS WITH 3-STATE OUTPUTS

SCBS058A – APRIL 1987 – REVISED NOVEMBER 1993

logic symbol†

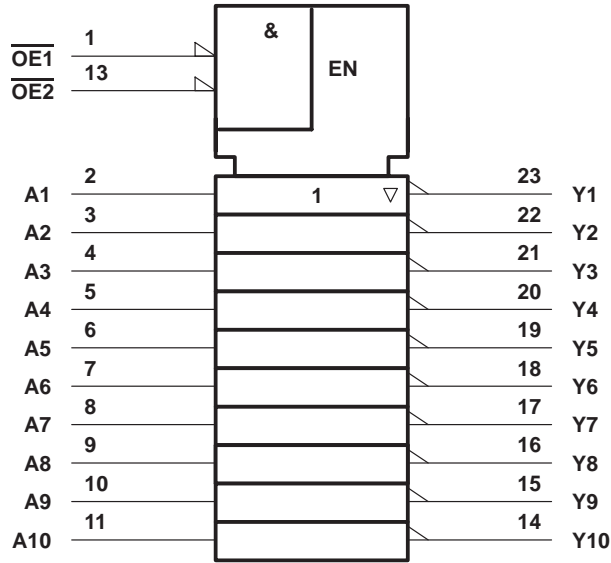

logic diagram (positive logic)

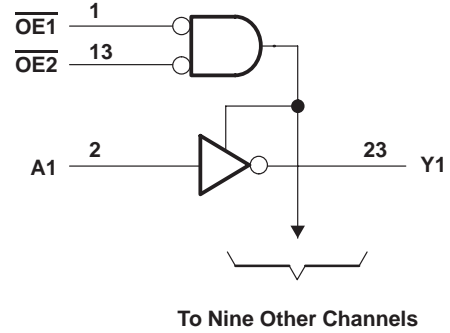

† This symbol is in accordance with ANSI/IEEE Std 91-1984 and IEC Publication 617-12.

Pin numbers shown are for the DW, JT, NT, and W packages.

schematic of each output

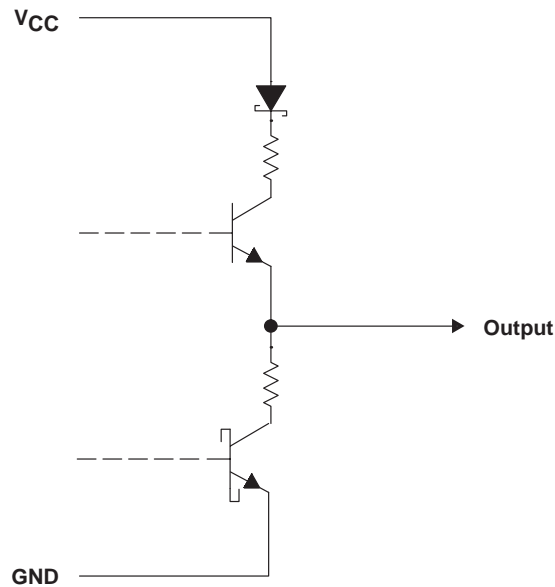

SN54BCT2828A, SN74BCT2828B 10-BIT BUS/MOS MEMORY DRIVERS WITH 3-STATE OUTPUTS

SCBS058A – APRIL 1987 – REVISED NOVEMBER 1993

absolute maximum ratings over operating free-air temperature range (unless otherwise noted)†

Supply voltage range, V_{CC}	–0.5 V to 7 V
Input voltage range, V_I (see Note 1)	–0.5 V to 7 V
Voltage range applied to any output in the disabled or power-off state, V_O	–0.5 V to 7 V
Voltage range applied to any output in the high state, V_O	–0.5 V to V_{CC}
Input clamp current, I_{IK} ($V_I < 0$)	–30 mA
Current into any output in the low state, I_O	24 mA
Operating free-air temperature range: SN54BCT2828A	–55°C to 125°C
SN74BCT2828B	0°C to 70°C
Storage temperature range	–65°C to 150°C

† Stresses beyond those listed under “absolute maximum ratings” may cause permanent damage to the device. These are stress ratings only, and functional operation of the device at these or any other conditions beyond those indicated under “recommended operating conditions” is not implied. Exposure to absolute-maximum-rated conditions for extended periods may affect device reliability.

NOTE 1: The input negative-voltage rating may be exceeded if the input clamp-current rating is observed.

recommended operating conditions (see Note 2)

	SN54BCT2828A			SN74BCT2828B			UNIT
	MIN	NOM	MAX	MIN	NOM	MAX	
V_{CC} Supply voltage	4.5	5	5.5	4.5	5	5.5	V
V_{IH} High-level input voltage	2			2			V
V_{IL} Low-level input voltage			0.8			0.8	V
I_{IK} Input clamp current			–18			–18	mA
I_{OH} High-level output current			–1			–1	mA
I_{OL} Low-level output current			12			12	mA
T_A Operating free-air temperature	–55		125	0		70	°C

NOTE 2: Unused or floating inputs must be held high or low.

electrical characteristics over recommended operating free-air temperature range (unless otherwise noted)

PARAMETER	TEST CONDITIONS	SN54BCT2828A			SN74BCT2828B			UNIT
		MIN	TYP‡	MAX	MIN	TYP‡	MAX	
V_{IK}	$V_{CC} = 4.5$ V, $I_I = -18$ mA			–1.2			–1.2	V
V_{OH}	$V_{CC} = 4.5$ V to 5.5 V, $I_{OH} = -1$ mA	$V_{CC}-2$			$V_{CC}-2$			V
V_{OL}	$V_{CC} = 4.5$ V, $I_{OL} = 1$ mA		0.35	0.5		0.35	0.5	V
						0.42	0.8	
I_I	$V_{CC} = 5.5$ V, $V_I = 7$ V			0.1			0.1	mA
I_{IH}	$V_{CC} = 5.5$ V, $V_I = 2.7$ V			20			20	μA
I_{IL}	$V_{CC} = 5.5$ V, $V_I = 0.5$ V			–0.2			–0.2	mA
I_{OZH}	$V_{CC} = 5.5$ V, $V_O = 2.7$ V			20			20	μA
I_{OZL}	$V_{CC} = 5.5$ V, $V_O = 0.5$ V			–20			–20	μA
I_{OL}	$V_{CC} = 4.5$ V, $V_O = 2$ V	50			50			mA
$I_{O§}$	$V_{CC} = 5.5$ V, $V_O = 2.25$ V	–30		–112	–30		–112	mA
I_{CCL}	$V_{CC} = 5.5$ V, Outputs open		28		28	40		mA
I_{CCZ}	$V_{CC} = 5.5$ V, Outputs open		3.5		3.5	6		mA
C_i	$V_{CC} = 5$ V, $V_I = 2.5$ V or 0.5 V		5		5			pF
C_o	$V_{CC} = 5$ V, $V_O = 2.5$ V or 0.5 V		8		8			pF

‡ All typical values are at $V_{CC} = 5$ V, $T_A = 25$ °C.

§ Not more than one output should be tested at a time, and the duration of the test should not exceed one second.



SN54BCT2828A, SN74BCT2828B
10-BIT BUS/MOS MEMORY DRIVERS
WITH 3-STATE OUTPUTS

SCBS058A – APRIL 1987 – REVISED NOVEMBER 1993

switching characteristics over recommended ranges of supply voltage and operating free-air temperature, $C_L = 50$ pF (unless otherwise noted) (see Note 3)

PARAMETER	FROM (INPUT)	TO (OUTPUT)	$V_{CC} = 5$ V, $T_A = 25^\circ$ C			SN54BCT2828A		SN74BCT2828B		UNIT
			MIN	TYP	MAX	MIN	MAX	MIN	MAX	
t_{PLH}	A	Y	1.8	2.7	5.9	1.5	10	1.3	6.6	ns
t_{PHL}			1.2	3.1	4.8	1.5	9	0.9	5	
t_{PZH}	\overline{OE}	Y	3.6	5.8	7.8	2	15	2.9	9	ns
t_{PZL}			5.5	7.9	10.2	2	21	4.8	11.5	
t_{PHZ}	\overline{OE}	Y	4.7	7.2	9.3	2	18	3.8	10.8	ns
t_{PLZ}			3.3	5.4	7.2	2	15	2.7	8.7	

NOTE 3: Load circuits and voltage waveforms are shown in Section 1.



PACKAGING INFORMATION

Orderable Device	Status ⁽¹⁾	Package Type	Package Drawing	Pins	Package Qty	Eco Plan ⁽²⁾	Lead/Ball Finish	MSL Peak Temp ⁽³⁾
SN74BCT2828BDW	OBSOLETE	SOIC	DW	24		TBD	Call TI	Call TI
SN74BCT2828BNT	OBSOLETE	PDIP	NT	24		TBD	Call TI	Call TI
SNJ54BCT2828AFK	OBSOLETE	LCCC	FK	28		TBD	Call TI	Call TI
SNJ54BCT2828AJT	OBSOLETE	CDIP	JT	24		TBD	Call TI	Call TI
SNJ54BCT2828AW	OBSOLETE	CFP	W	24		TBD	Call TI	Call TI

⁽¹⁾ The marketing status values are defined as follows:

ACTIVE: Product device recommended for new designs.

LIFEBUY: TI has announced that the device will be discontinued, and a lifetime-buy period is in effect.

NRND: Not recommended for new designs. Device is in production to support existing customers, but TI does not recommend using this part in a new design.

PREVIEW: Device has been announced but is not in production. Samples may or may not be available.

OBSOLETE: TI has discontinued the production of the device.

⁽²⁾ Eco Plan - The planned eco-friendly classification: Pb-Free (RoHS), Pb-Free (RoHS Exempt), or Green (RoHS & no Sb/Br) - please check <http://www.ti.com/productcontent> for the latest availability information and additional product content details.

TBD: The Pb-Free/Green conversion plan has not been defined.

Pb-Free (RoHS): TI's terms "Lead-Free" or "Pb-Free" mean semiconductor products that are compatible with the current RoHS requirements for all 6 substances, including the requirement that lead not exceed 0.1% by weight in homogeneous materials. Where designed to be soldered at high temperatures, TI Pb-Free products are suitable for use in specified lead-free processes.

Pb-Free (RoHS Exempt): This component has a RoHS exemption for either 1) lead-based flip-chip solder bumps used between the die and package, or 2) lead-based die adhesive used between the die and leadframe. The component is otherwise considered Pb-Free (RoHS compatible) as defined above.

Green (RoHS & no Sb/Br): TI defines "Green" to mean Pb-Free (RoHS compatible), and free of Bromine (Br) and Antimony (Sb) based flame retardants (Br or Sb do not exceed 0.1% by weight in homogeneous material)

⁽³⁾ MSL, Peak Temp. -- The Moisture Sensitivity Level rating according to the JEDEC industry standard classifications, and peak solder temperature.

Important Information and Disclaimer:The information provided on this page represents TI's knowledge and belief as of the date that it is provided. TI bases its knowledge and belief on information provided by third parties, and makes no representation or warranty as to the accuracy of such information. Efforts are underway to better integrate information from third parties. TI has taken and continues to take reasonable steps to provide representative and accurate information but may not have conducted destructive testing or chemical analysis on incoming materials and chemicals. TI and TI suppliers consider certain information to be proprietary, and thus CAS numbers and other limited information may not be available for release.

In no event shall TI's liability arising out of such information exceed the total purchase price of the TI part(s) at issue in this document sold by TI to Customer on an annual basis.

JT (R-GDIP-T**)

CERAMIC DUAL-IN-LINE

24 LEADS SHOWN



4040110/C 08/96

- NOTES: A. All linear dimensions are in inches (millimeters).
 B. This drawing is subject to change without notice.
 C. This package can be hermetically sealed with a ceramic lid using glass frit.
 D. Index point is provided on cap for terminal identification.
 E. Falls within MIL STD 1835 GDIP3-T24, GDIP4-T28, and JEDEC MO-058 AA, MO-058 AB

W (R-GDFP-F24)

CERAMIC DUAL FLATPACK

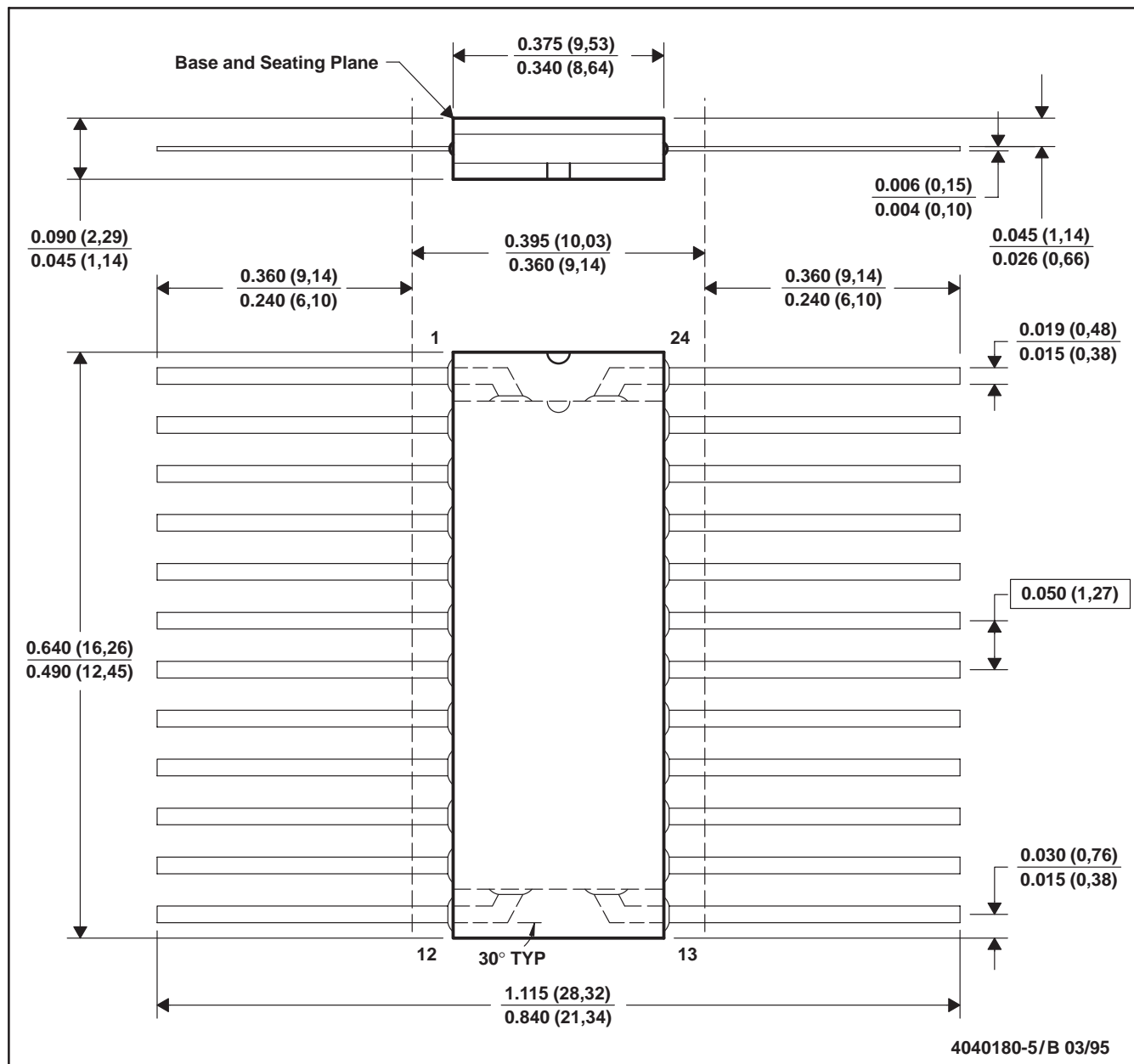

- NOTES:
- All linear dimensions are in inches (millimeters).
 - This drawing is subject to change without notice.
 - This package can be hermetically sealed with a ceramic lid using glass frit.
 - Falls within MIL-STD-1835 GDFP2-F24 and JEDEC MO-070AD
 - Index point is provided on cap for terminal identification only.

FK (S-CQCC-N**)

LEADLESS CERAMIC CHIP CARRIER

28 TERMINAL SHOWN



NO. OF TERMINALS **	A		B	
	MIN	MAX	MIN	MAX
20	0.342 (8,69)	0.358 (9,09)	0.307 (7,80)	0.358 (9,09)
28	0.442 (11,23)	0.458 (11,63)	0.406 (10,31)	0.458 (11,63)
44	0.640 (16,26)	0.660 (16,76)	0.495 (12,58)	0.560 (14,22)
52	0.740 (18,78)	0.761 (19,32)	0.495 (12,58)	0.560 (14,22)
68	0.938 (23,83)	0.962 (24,43)	0.850 (21,6)	0.858 (21,8)
84	1.141 (28,99)	1.165 (29,59)	1.047 (26,6)	1.063 (27,0)



4040140/D 01/11

- NOTES:
- All linear dimensions are in inches (millimeters).
 - This drawing is subject to change without notice.
 - This package can be hermetically sealed with a metal lid.
 - Falls within JEDEC MS-004

MECHANICAL DATA

NT (R-PDIP-T**) 24 PINS SHOWN

PLASTIC DUAL-IN-LINE PACKAGE



- NOTES:
- A. All linear dimensions are in millimeters. Dimensioning and tolerancing per ASME Y14.5M-1994.
 - B. This drawing is subject to change without notice.
 -  The 28 pin end lead shoulder width is a vendor option, either half or full width.

DW (R-PDSO-G24)

PLASTIC SMALL OUTLINE



- NOTES:
- A. All linear dimensions are in inches (millimeters). Dimensioning and tolerancing per ASME Y14.5M-1994.
 - B. This drawing is subject to change without notice.
 - C. Body dimensions do not include mold flash or protrusion not to exceed 0.006 (0,15).
 - D. Falls within JEDEC MS-013 variation AD.

IMPORTANT NOTICE

Texas Instruments Incorporated and its subsidiaries (TI) reserve the right to make corrections, enhancements, improvements and other changes to its semiconductor products and services per JESD46C and to discontinue any product or service per JESD48B. Buyers should obtain the latest relevant information before placing orders and should verify that such information is current and complete. All semiconductor products (also referred to herein as "components") are sold subject to TI's terms and conditions of sale supplied at the time of order acknowledgment.

TI warrants performance of its components to the specifications applicable at the time of sale, in accordance with the warranty in TI's terms and conditions of sale of semiconductor products. Testing and other quality control techniques are used to the extent TI deems necessary to support this warranty. Except where mandated by applicable law, testing of all parameters of each component is not necessarily performed.

TI assumes no liability for applications assistance or the design of Buyers' products. Buyers are responsible for their products and applications using TI components. To minimize the risks associated with Buyers' products and applications, Buyers should provide adequate design and operating safeguards.

TI does not warrant or represent that any license, either express or implied, is granted under any patent right, copyright, mask work right, or other intellectual property right relating to any combination, machine, or process in which TI components or services are used. Information published by TI regarding third-party products or services does not constitute a license to use such products or services or a warranty or endorsement thereof. Use of such information may require a license from a third party under the patents or other intellectual property of the third party, or a license from TI under the patents or other intellectual property of TI.

Reproduction of significant portions of TI information in TI data books or data sheets is permissible only if reproduction is without alteration and is accompanied by all associated warranties, conditions, limitations, and notices. TI is not responsible or liable for such altered documentation. Information of third parties may be subject to additional restrictions.

Resale of TI components or services with statements different from or beyond the parameters stated by TI for that component or service voids all express and any implied warranties for the associated TI component or service and is an unfair and deceptive business practice. TI is not responsible or liable for any such statements.

Buyer acknowledges and agrees that it is solely responsible for compliance with all legal, regulatory and safety-related requirements concerning its products, and any use of TI components in its applications, notwithstanding any applications-related information or support that may be provided by TI. Buyer represents and agrees that it has all the necessary expertise to create and implement safeguards which anticipate dangerous consequences of failures, monitor failures and their consequences, lessen the likelihood of failures that might cause harm and take appropriate remedial actions. Buyer will fully indemnify TI and its representatives against any damages arising out of the use of any TI components in safety-critical applications.

In some cases, TI components may be promoted specifically to facilitate safety-related applications. With such components, TI's goal is to help enable customers to design and create their own end-product solutions that meet applicable functional safety standards and requirements. Nonetheless, such components are subject to these terms.

No TI components are authorized for use in FDA Class III (or similar life-critical medical equipment) unless authorized officers of the parties have executed a special agreement specifically governing such use.

Only those TI components which TI has specifically designated as military grade or "enhanced plastic" are designed and intended for use in military/aerospace applications or environments. Buyer acknowledges and agrees that any military or aerospace use of TI components which have **not** been so designated is solely at the Buyer's risk, and that Buyer is solely responsible for compliance with all legal and regulatory requirements in connection with such use.

TI has specifically designated certain components which meet ISO/TS16949 requirements, mainly for automotive use. Components which have not been so designated are neither designed nor intended for automotive use; and TI will not be responsible for any failure of such components to meet such requirements.

Products

Audio	www.ti.com/audio
Amplifiers	amplifier.ti.com
Data Converters	dataconverter.ti.com
DLP® Products	www.dlp.com
DSP	dsp.ti.com
Clocks and Timers	www.ti.com/clocks
Interface	interface.ti.com
Logic	logic.ti.com
Power Mgmt	power.ti.com
Microcontrollers	microcontroller.ti.com
RFID	www.ti-rfid.com
OMAP Mobile Processors	www.ti.com/omap
Wireless Connectivity	www.ti.com/wirelessconnectivity

Applications

Automotive and Transportation	www.ti.com/automotive
Communications and Telecom	www.ti.com/communications
Computers and Peripherals	www.ti.com/computers
Consumer Electronics	www.ti.com/consumer-apps
Energy and Lighting	www.ti.com/energy
Industrial	www.ti.com/industrial
Medical	www.ti.com/medical
Security	www.ti.com/security
Space, Avionics and Defense	www.ti.com/space-avionics-defense
Video and Imaging	www.ti.com/video

TI E2E Community e2e.ti.com