

FEATURES

- Available in the Texas Instruments NanoFree™ Package
- Optimized for 1.8-V Operation and Is 3.6-V I/O Tolerant to Support Mixed-Mode Signal Operation
- I_{off} Supports Partial-Power-Down Mode Operation
- Sub-1-V Operable
- Max t_{pd} of 1.7 ns at 1.8 V
- Low Power Consumption, 10- μ A Max I_{CC}
- ± 8 -mA Output Drive at 1.8 V
- Latch-Up Performance Exceeds 100 mA Per JESD 78, Class II
- ESD Protection Exceeds JESD 22
 - 2000-V Human-Body Model (A114-A)
 - 200-V Machine Model (A115-A)
 - 1000-V Charged-Device Model (C101)

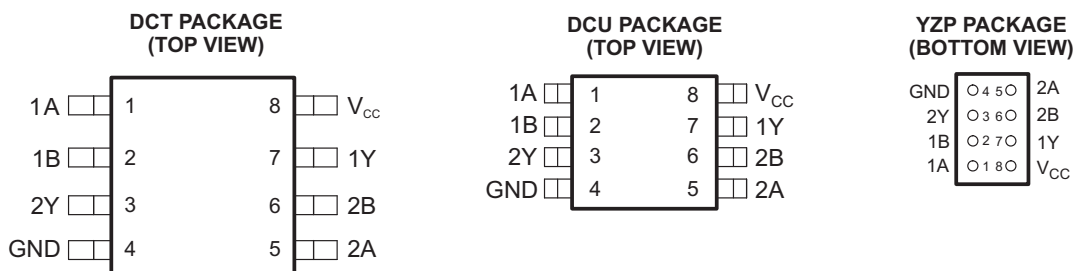

See mechanical drawings for dimensions.

DESCRIPTION/ORDERING INFORMATION

This dual 2-input exclusive-OR gate is operational at 0.8-V to 2.7-V V_{CC} , but is designed specifically for 1.65-V to 1.95-V V_{CC} operation.

The SN74AUC2G86 performs the Boolean function $Y = A \oplus B$ or $Y = \bar{A}B + A\bar{B}$ in positive logic.

A common application is as a true/complement element. If the input is low, the other input is reproduced in true form at the output. If the input is high, the signal on the other input is reproduced inverted at the output.

NanoFree™ package technology is a major breakthrough in IC packaging concepts, using the die as the package.

This device is fully specified for partial-power-down applications using I_{off} . The I_{off} circuitry disables the outputs, preventing damaging current backflow through the device when it is powered down.

ORDERING INFORMATION

| T_A | PACKAGE ⁽¹⁾ | | ORDERABLE PART NUMBER | TOP-SIDE MARKING ⁽²⁾ |
|---------------|--|--------------|-----------------------|---------------------------------|
| –40°C to 85°C | NanoFree™ – WCSP (DSBGA) 0.23-mm Large Bump – YZP (Pb-free) | Reel of 3000 | SN74AUC2G86YZPR | __ _UH_ |
| | SSOP – DCT | Reel of 3000 | SN74AUC2G86DCTR | U86_ _ _ |
| | VSSOP – DCU | Reel of 3000 | SN74AUC2G86DCUR | U86_ |

(1) Package drawings, standard packing quantities, thermal data, symbolization, and PCB design guidelines are available at www.ti.com/sc/package.

(2) DCT: The actual top-side marking has three additional characters that designate the year, month, and assembly/test site.
DCU: The actual top-side marking has one additional character that designates the assembly/test site.

YZP: The actual top-side marking has three preceding characters to denote year, month, and sequence code, and one following character to designate the assembly/test site.



Please be aware that an important notice concerning availability, standard warranty, and use in critical applications of Texas Instruments semiconductor products and disclaimers thereto appears at the end of this data sheet.

NanoFree is a trademark of Texas Instruments.

FUNCTION TABLE
(each gate)

| INPUTS | | OUTPUT Y |
|--------|---|-------------|
| A | B | |
| L | L | L |
| L | H | H |
| H | L | H |
| H | H | L |

EXCLUSIVE-OR LOGIC

An exclusive-OR gate has many applications, some of which can be represented better by alternative logic symbols.

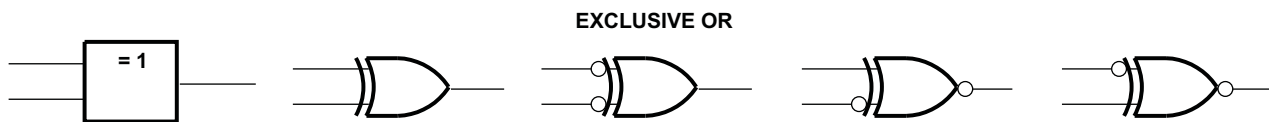

These are five equivalent exclusive-OR symbols valid for an SN74AUC2G86 gate in positive logic; negation may be shown at any two ports.

LOGIC-IDENTITY ELEMENT

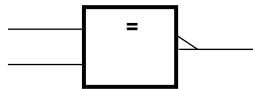

The output is active (low) if all inputs stand at the same logic level (i.e., $A = B$).

EVEN-PARITY ELEMENT

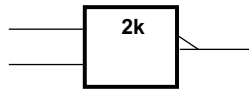

The output is active (low) if an even number of inputs (i.e., 0 or 2) are active.

ODD-PARITY ELEMENT

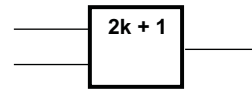

The output is active (high) if an odd number of inputs (i.e., only 1 of the 2) are active.

Absolute Maximum Ratings⁽¹⁾

over operating free-air temperature range (unless otherwise noted)

| | | MIN | MAX | UNIT |
|---------------|---|-------------|----------------|--------------------|
| V_{CC} | Supply voltage range | -0.5 | 3.6 | V |
| V_I | Input voltage range ⁽²⁾ | -0.5 | 3.6 | V |
| V_O | Voltage range applied to any output in the high-impedance or power-off state ⁽²⁾ | -0.5 | 3.6 | V |
| V_O | Output voltage range ⁽²⁾ | -0.5 | $V_{CC} + 0.5$ | V |
| I_{IK} | Input clamp current | $V_I < 0$ | | -50 mA |
| I_{OK} | Output clamp current | $V_O < 0$ | | -50 mA |
| I_O | Continuous output current | | | ± 20 mA |
| | Continuous current through V_{CC} or GND | | | ± 100 mA |
| θ_{JA} | Package thermal impedance ⁽³⁾ | DCT package | | 220 |
| | | DCU package | | 227 |
| | | YZP package | | 102 |
| T_{stg} | Storage temperature range | -65 | 150 | $^{\circ}\text{C}$ |

- (1) Stresses beyond those listed under "absolute maximum ratings" may cause permanent damage to the device. These are stress ratings only, and functional operation of the device at these or any other conditions beyond those indicated under "recommended operating conditions" is not implied. Exposure to absolute-maximum-rated conditions for extended periods may affect device reliability.
- (2) The input negative-voltage and output voltage ratings may be exceeded if the input and output current ratings are observed.
- (3) The package thermal impedance is calculated in accordance with JESD 51-7.

Recommended Operating Conditions⁽¹⁾

| | | MIN | MAX | UNIT |
|-----------------|------------------------------------|-----------------------------------|------------------------|------|
| V _{CC} | Supply voltage | 0.8 | 2.7 | V |
| V _{IH} | High-level input voltage | V _{CC} = 0.8 V | V _{CC} | V |
| | | V _{CC} = 1.1 V to 1.95 V | 0.65 × V _{CC} | |
| | | V _{CC} = 2.3 V to 2.7 V | 1.7 | |
| V _{IL} | Low-level input voltage | V _{CC} = 0.8 V | 0 | V |
| | | V _{CC} = 1.1 V to 1.95 V | 0.35 × V _{CC} | |
| | | V _{CC} = 2.3 V to 2.7 V | 0.7 | |
| V _I | Input voltage | 0 | 3.6 | V |
| V _O | Output voltage | 0 | V _{CC} | V |
| I _{OH} | High-level output current | V _{CC} = 0.8 V | –0.7 | mA |
| | | V _{CC} = 1.1 V | –3 | |
| | | V _{CC} = 1.4 V | –5 | |
| | | V _{CC} = 1.65 V | –8 | |
| | | V _{CC} = 2.3 V | –9 | |
| I _{OL} | Low-level output current | V _{CC} = 0.8 V | 0.7 | mA |
| | | V _{CC} = 1.1 V | 3 | |
| | | V _{CC} = 1.4 V | 5 | |
| | | V _{CC} = 1.65 V | 8 | |
| | | V _{CC} = 2.3 V | 9 | |
| Δt/Δv | Input transition rise or fall rate | | 20 | ns/V |
| T _A | Operating free-air temperature | –40 | 85 | °C |

(1) All unused inputs of the device must be held at V_{CC} or GND to ensure proper device operation. Refer to the TI application report, *Implications of Slow or Floating CMOS Inputs*, literature number SCBA004.

Electrical Characteristics

over recommended operating free-air temperature range (unless otherwise noted)

| PARAMETER | TEST CONDITIONS | V _{CC} | MIN | TYP ⁽¹⁾ | MAX | UNIT |
|------------------|---------------------------|---|-----------------------|--------------------|------|------|
| V _{OH} | I _{OH} = –100 μA | 0.8 V to 2.7 V | V _{CC} – 0.1 | | | V |
| | I _{OH} = –0.7 mA | 0.8 V | | 0.55 | | |
| | I _{OH} = –3 mA | 1.1 V | | 0.8 | | |
| | I _{OH} = –5 mA | 1.4 V | | 1 | | |
| | I _{OH} = –8 mA | 1.65 V | | 1.2 | | |
| | I _{OH} = –9 mA | 2.3 V | | 1.8 | | |
| V _{OL} | I _{OL} = 100 μA | 0.8 V to 2.7 V | | | 0.2 | V |
| | I _{OL} = 0.7 mA | 0.8 V | | 0.25 | | |
| | I _{OL} = 3 mA | 1.1 V | | | 0.3 | |
| | I _{OL} = 5 mA | 1.4 V | | | 0.4 | |
| | I _{OL} = 8 mA | 1.65 V | | | 0.45 | |
| | I _{OL} = 9 mA | 2.3 V | | | 0.6 | |
| I _I | A or B inputs | V _I = V _{CC} or GND | 0 to 2.7 V | | ±5 | μA |
| I _{off} | | V _I or V _O = 2.7 V | 0 | | ±10 | μA |
| I _{CC} | | V _I = V _{CC} or GND, I _O = 0 | 0.8 V to 2.7 V | | 10 | μA |
| C _i | | V _I = V _{CC} or GND | 2.5 V | | 2.5 | pF |

(1) All typical values are at T_A = 25°C.

SN74AUC2G86

DUAL 2-INPUT EXCLUSIVE-OR GATE

SCES479B – AUGUST 2003 – REVISED JANUARY 2007

Switching Characteristics

over recommended operating free-air temperature range, $C_L = 15$ pF (unless otherwise noted) (see [Figure 1](#))

| PARAMETER | FROM (INPUT) | TO (OUTPUT) | $V_{CC} = 0.8$ V | $V_{CC} = 1.2$ V ± 0.1 V | | $V_{CC} = 1.5$ V ± 0.1 V | | $V_{CC} = 1.8$ V ± 0.15 V | | | $V_{CC} = 2.5$ V ± 0.2 V | | UNIT |
|-----------|--------------|-------------|------------------|---------------------------------|-----|---------------------------------|-----|----------------------------------|-----|-----|---------------------------------|-----|------|
| | | | TYP | MIN | MAX | MIN | MAX | MIN | TYP | MAX | MIN | MAX | |
| t_{pd} | A or B | Y | 5.3 | 0.8 | 3.8 | 0.5 | 2.6 | 0.4 | 1 | 1.7 | 0.3 | 1.3 | ns |

Switching Characteristics

over recommended operating free-air temperature range, $C_L = 30$ pF (unless otherwise noted) (see [Figure 1](#))

| PARAMETER | FROM (INPUT) | TO (OUTPUT) | $V_{CC} = 1.8$ V ± 0.15 V | | | $V_{CC} = 2.5$ V ± 0.2 V | | UNIT |
|-----------|--------------|-------------|----------------------------------|-----|-----|---------------------------------|-----|------|
| | | | MIN | TYP | MAX | MIN | MAX | |
| t_{pd} | A or B | Y | 0.8 | 1.5 | 2.6 | 0.7 | 2 | ns |

Operating Characteristics

$T_A = 25^\circ\text{C}$

| PARAMETER | TEST CONDITIONS | $V_{CC} = 0.8$ V | $V_{CC} = 1.2$ V | $V_{CC} = 1.5$ V | $V_{CC} = 1.8$ V | $V_{CC} = 2.5$ V | UNIT |
|-----------|---|------------------|------------------|------------------|------------------|------------------|------|
| | | TYP | TYP | TYP | TYP | TYP | |
| C_{pd} | Power dissipation capacitance f = 10 MHz | 15 | 15 | 16 | 19 | 27 | pF |

PARAMETER MEASUREMENT INFORMATION



| TEST | S1 |
|-------------------|-------------------|
| t_{PLH}/t_{PHL} | Open |
| t_{PZL}/t_{PZH} | $2 \times V_{CC}$ |
| t_{PHZ}/t_{PZH} | GND |

| V_{CC} | C_L | R_L | V_A |
|----------------|-------|-------|--------|
| 0.8 V | 15 pF | 2 kΩ | 0.1 V |
| 1.2 V ± 0.1 V | 15 pF | 2 kΩ | 0.1 V |
| 1.5 V ± 0.1 V | 15 pF | 2 kΩ | 0.1 V |
| 1.8 V ± 0.15 V | 15 pF | 2 kΩ | 0.15 V |
| 2.5 V ± 0.2 V | 15 pF | 2 kΩ | 0.15 V |
| 1.8 V ± 0.15 V | 30 pF | 1 kΩ | 0.15 V |
| 2.5 V ± 0.2 V | 30 pF | 500 Ω | 0.15 V |



- NOTES: A. C_L includes probe and jig capacitance.
 B. Waveform 1 is for an output with internal conditions such that the output is low, except when disabled by the output control. Waveform 2 is for an output with internal conditions such that the output is high, except when disabled by the output control.
 C. All input pulses are supplied by generators having the following characteristics: PRR ≤ 10 MHz, $Z_o = 50 \Omega$, slew rate ≥ 1 V/ns.
 D. The outputs are measured one at a time, with one transition per measurement.
 E. t_{PZL} and t_{PZH} are the same as t_{dis} .
 F. t_{PZL} and t_{PZH} are the same as t_{en} .
 G. t_{PLH} and t_{PHL} are the same as t_{pd} .

Figure 1. Load Circuit and Voltage Waveforms

PACKAGING INFORMATION

| Orderable Device | Status (1) | Package Type | Package Drawing | Pins | Package Qty | Eco Plan (2) | Lead/Ball Finish | MSL Peak Temp (3) | Op Temp (°C) | Top-Side Markings (4) | Samples |
|-------------------|---------------|--------------|-----------------|------|-------------|-------------------------|------------------|----------------------|--------------|--------------------------|-------------------------|
| SN74AUC2G86DCTR | ACTIVE | SM8 | DCT | 8 | 3000 | Green (RoHS & no Sb/Br) | CU NIPDAU | Level-1-260C-UNLIM | -40 to 85 | U86 Z | Samples |
| SN74AUC2G86DCTRE4 | ACTIVE | SM8 | DCT | 8 | 3000 | Green (RoHS & no Sb/Br) | CU NIPDAU | Level-1-260C-UNLIM | -40 to 85 | U86 Z | Samples |
| SN74AUC2G86DCTRG4 | ACTIVE | SM8 | DCT | 8 | 3000 | Green (RoHS & no Sb/Br) | CU NIPDAU | Level-1-260C-UNLIM | -40 to 85 | U86 Z | Samples |
| SN74AUC2G86DCUR | ACTIVE | US8 | DCU | 8 | 3000 | Green (RoHS & no Sb/Br) | CU NIPDAU | Level-1-260C-UNLIM | -40 to 85 | U86R | Samples |
| SN74AUC2G86DCURE4 | ACTIVE | US8 | DCU | 8 | 3000 | Green (RoHS & no Sb/Br) | CU NIPDAU | Level-1-260C-UNLIM | -40 to 85 | U86R | Samples |
| SN74AUC2G86DCURG4 | ACTIVE | US8 | DCU | 8 | 3000 | Green (RoHS & no Sb/Br) | CU NIPDAU | Level-1-260C-UNLIM | -40 to 85 | U86R | Samples |
| SN74AUC2G86YZPR | ACTIVE | DSBGA | YZP | 8 | 3000 | Green (RoHS & no Sb/Br) | SNAGCU | Level-1-260C-UNLIM | -40 to 85 | (UH7 ~ UHN) | Samples |

(1) The marketing status values are defined as follows:

ACTIVE: Product device recommended for new designs.

LIFEBUY: TI has announced that the device will be discontinued, and a lifetime-buy period is in effect.

NRND: Not recommended for new designs. Device is in production to support existing customers, but TI does not recommend using this part in a new design.

PREVIEW: Device has been announced but is not in production. Samples may or may not be available.

OBSELETE: TI has discontinued the production of the device.

(2) Eco Plan - The planned eco-friendly classification: Pb-Free (RoHS), Pb-Free (RoHS Exempt), or Green (RoHS & no Sb/Br) - please check <http://www.ti.com/productcontent> for the latest availability information and additional product content details.

TBD: The Pb-Free/Green conversion plan has not been defined.

Pb-Free (RoHS): TI's terms "Lead-Free" or "Pb-Free" mean semiconductor products that are compatible with the current RoHS requirements for all 6 substances, including the requirement that lead not exceed 0.1% by weight in homogeneous materials. Where designed to be soldered at high temperatures, TI Pb-Free products are suitable for use in specified lead-free processes.

Pb-Free (RoHS Exempt): This component has a RoHS exemption for either 1) lead-based flip-chip solder bumps used between the die and package, or 2) lead-based die adhesive used between the die and leadframe. The component is otherwise considered Pb-Free (RoHS compatible) as defined above.

Green (RoHS & no Sb/Br): TI defines "Green" to mean Pb-Free (RoHS compatible), and free of Bromine (Br) and Antimony (Sb) based flame retardants (Br or Sb do not exceed 0.1% by weight in homogeneous material)

(3) MSL, Peak Temp. -- The Moisture Sensitivity Level rating according to the JEDEC industry standard classifications, and peak solder temperature.

(4) Multiple Top-Side Markings will be inside parentheses. Only one Top-Side Marking contained in parentheses and separated by a "~" will appear on a device. If a line is indented then it is a continuation of the previous line and the two combined represent the entire Top-Side Marking for that device.

Important Information and Disclaimer: The information provided on this page represents TI's knowledge and belief as of the date that it is provided. TI bases its knowledge and belief on information provided by third parties, and makes no representation or warranty as to the accuracy of such information. Efforts are underway to better integrate information from third parties. TI has taken and continues to take reasonable steps to provide representative and accurate information but may not have conducted destructive testing or chemical analysis on incoming materials and chemicals. TI and TI suppliers consider certain information to be proprietary, and thus CAS numbers and other limited information may not be available for release.

In no event shall TI's liability arising out of such information exceed the total purchase price of the TI part(s) at issue in this document sold by TI to Customer on an annual basis.

TAPE AND REEL INFORMATION



QUADRANT ASSIGNMENTS FOR PIN 1 ORIENTATION IN TAPE



*All dimensions are nominal

| Device | Package Type | Package Drawing | Pins | SPQ | Reel Diameter (mm) | Reel Width W1 (mm) | A0 (mm) | B0 (mm) | K0 (mm) | P1 (mm) | W (mm) | Pin1 Quadrant |
|-----------------|--------------|-----------------|------|------|--------------------|--------------------|---------|---------|---------|---------|--------|---------------|
| SN74AUC2G86DCUR | US8 | DCU | 8 | 3000 | 180.0 | 8.4 | 2.25 | 3.35 | 1.05 | 4.0 | 8.0 | Q3 |
| SN74AUC2G86YZPR | DSBGA | YZP | 8 | 3000 | 178.0 | 9.2 | 1.02 | 2.02 | 0.63 | 4.0 | 8.0 | Q1 |

TAPE AND REEL BOX DIMENSIONS

*All dimensions are nominal

| Device | Package Type | Package Drawing | Pins | SPQ | Length (mm) | Width (mm) | Height (mm) |
|-----------------|--------------|-----------------|------|------|-------------|------------|-------------|
| SN74AUC2G86DCUR | US8 | DCU | 8 | 3000 | 202.0 | 201.0 | 28.0 |
| SN74AUC2G86YZPR | DSBGA | YZP | 8 | 3000 | 220.0 | 220.0 | 35.0 |

DCT (R-PDSO-G8)

PLASTIC SMALL-OUTLINE PACKAGE



4188781/C 09/02

- NOTES: A. All linear dimensions are in millimeters.
 B. This drawing is subject to change without notice.
 C. Body dimensions do not include mold flash or protrusion.
 D. Falls within JEDEC MO-187 variation DA.

DCT (R-PDSO-G8)

PLASTIC SMALL OUTLINE

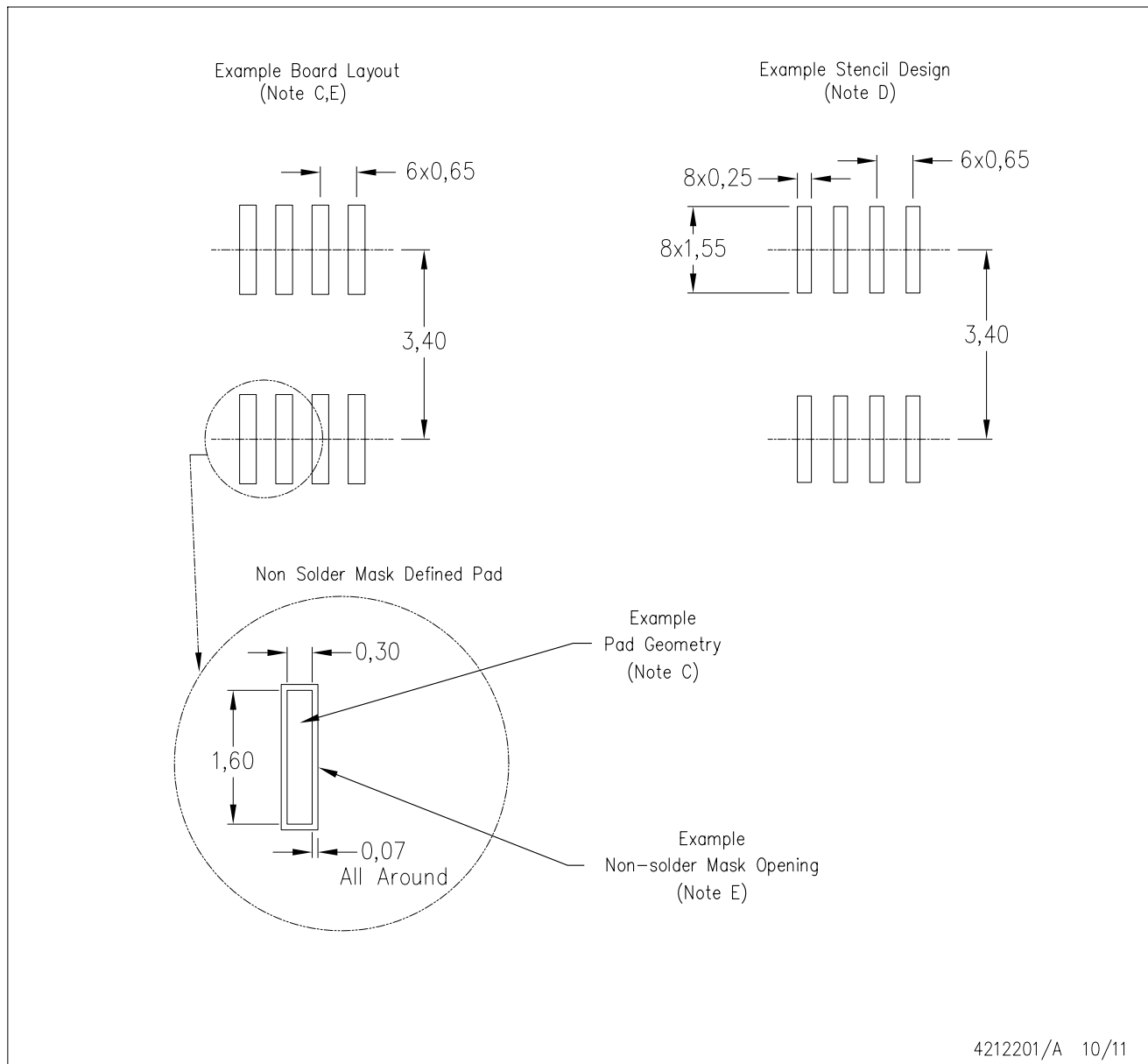

- NOTES:
- A. All linear dimensions are in millimeters.
 - B. This drawing is subject to change without notice.
 - C. Publication IPC-7351 is recommended for alternate designs.
 - D. Laser cutting apertures with trapezoidal walls and also rounding corners will offer better paste release. Customers should contact their board assembly site for stencil design recommendations. Refer to IPC-7525.
 - E. Customers should contact their board fabrication site for solder mask tolerances between and around signal pads.

DCU (R-PDSO-G8)

PLASTIC SMALL-OUTLINE PACKAGE (DIE DOWN)

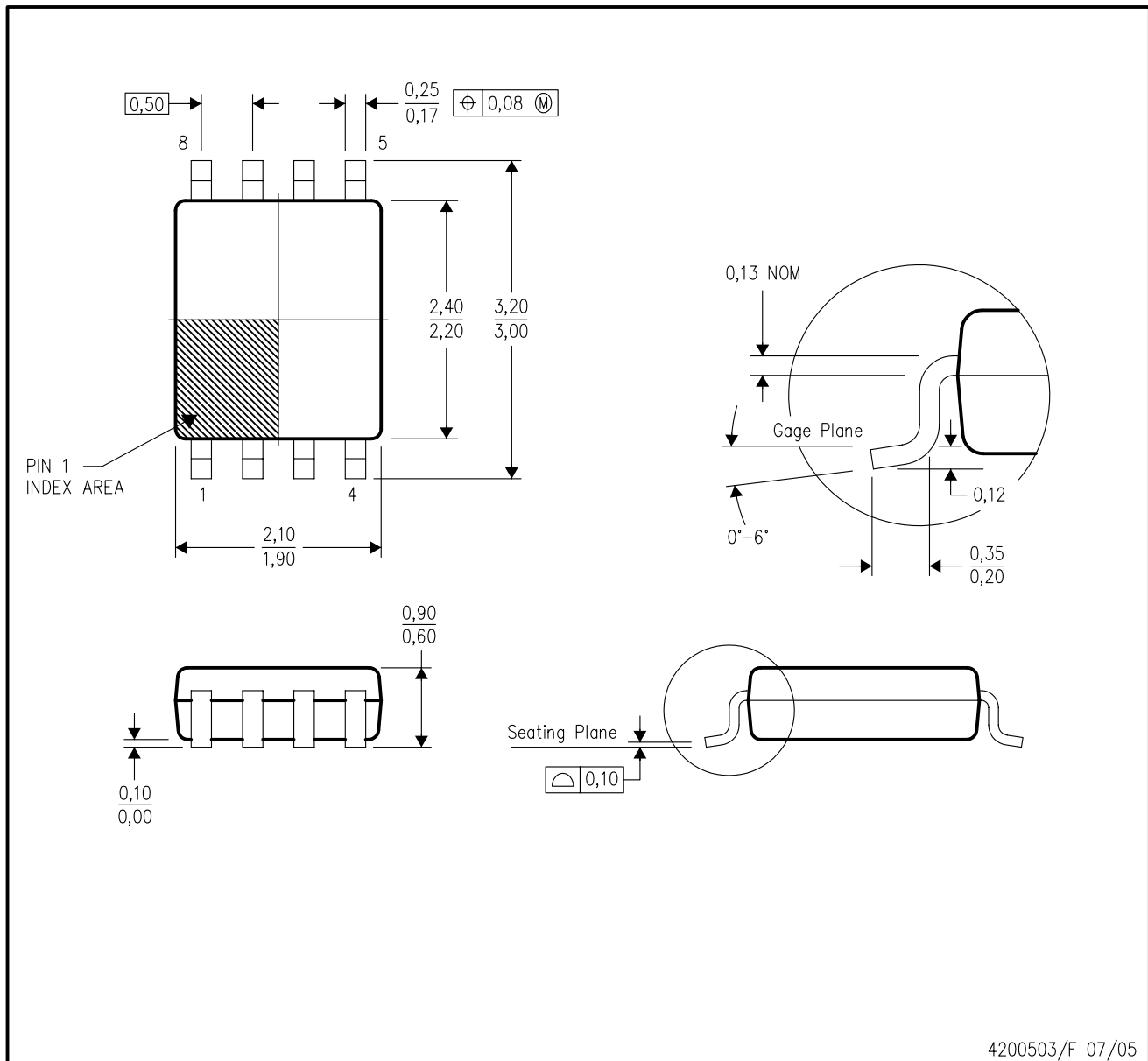

- NOTES:
- All linear dimensions are in millimeters.
 - This drawing is subject to change without notice.
 - Body dimensions do not include mold flash or protrusion. Mold flash and protrusion shall not exceed 0.15 per side.
 - Falls within JEDEC MO-187 variation CA.

DCU (S-PDSO-G8)

PLASTIC SMALL OUTLINE PACKAGE (DIE DOWN)



4210064/C 04/12

- NOTES:
- A. All linear dimensions are in millimeters.
 - B. This drawing is subject to change without notice.
 - C. Publication IPC-7351 is recommended for alternate designs.
 - D. Laser cutting apertures with trapezoidal walls and also rounding corners will offer better paste release. Customers should contact their board assembly site for stencil design recommendations. Refer to IPC-7525 for other stencil recommendations.
 - E. Customers should contact their board fabrication site for solder mask tolerances between and around signal pads.

YZP (R-XBGA-N8)

DIE-SIZE BALL GRID ARRAY

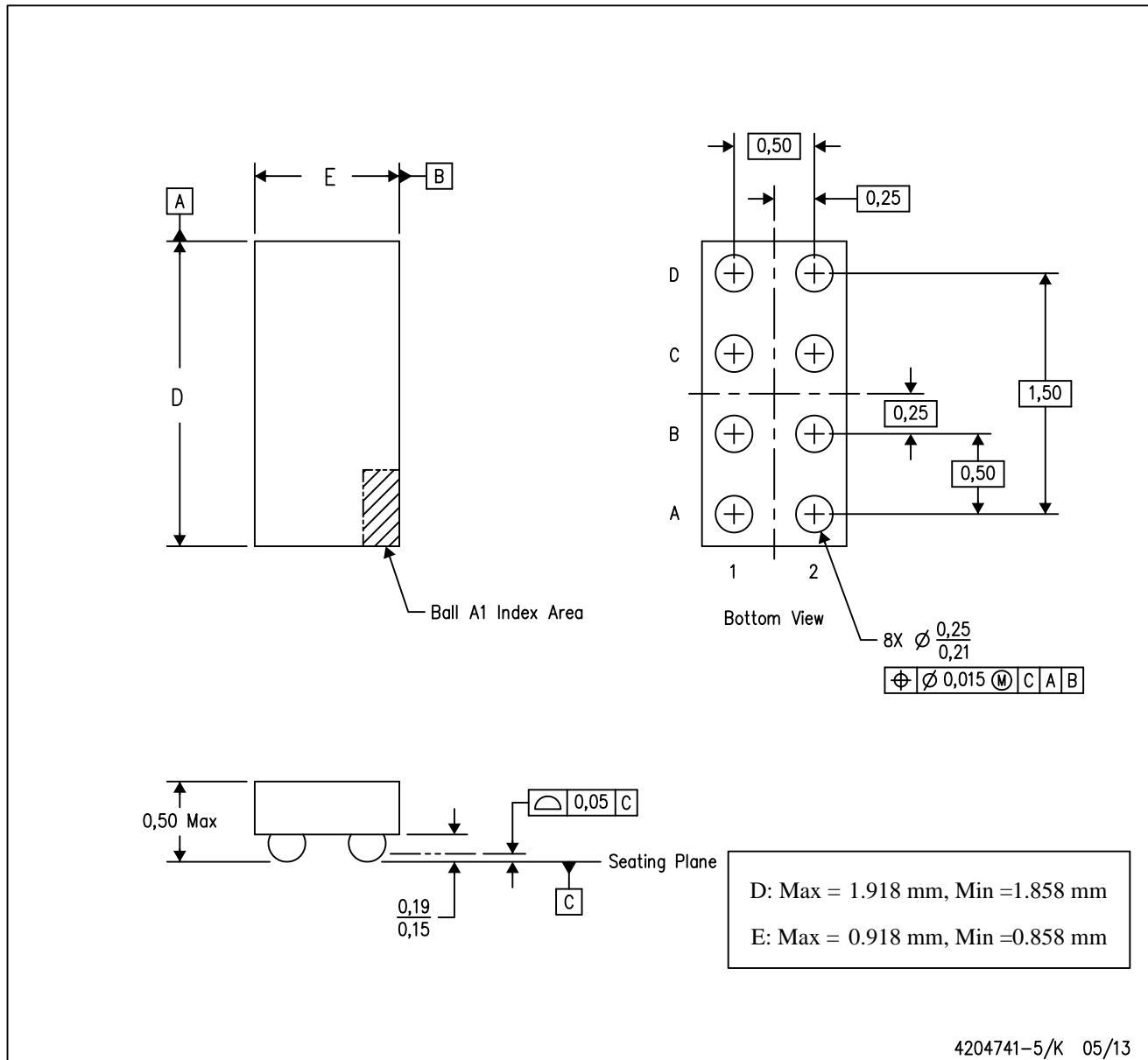

- NOTES:
- A. All linear dimensions are in millimeters. Dimensioning and tolerancing per ASME Y14.5M-1994.
 - B. This drawing is subject to change without notice.
 - C. NanoFree™ package configuration.

NanoFree is a trademark of Texas Instruments.

IMPORTANT NOTICE

Texas Instruments Incorporated and its subsidiaries (TI) reserve the right to make corrections, enhancements, improvements and other changes to its semiconductor products and services per JESD46, latest issue, and to discontinue any product or service per JESD48, latest issue. Buyers should obtain the latest relevant information before placing orders and should verify that such information is current and complete. All semiconductor products (also referred to herein as "components") are sold subject to TI's terms and conditions of sale supplied at the time of order acknowledgment.

TI warrants performance of its components to the specifications applicable at the time of sale, in accordance with the warranty in TI's terms and conditions of sale of semiconductor products. Testing and other quality control techniques are used to the extent TI deems necessary to support this warranty. Except where mandated by applicable law, testing of all parameters of each component is not necessarily performed.

TI assumes no liability for applications assistance or the design of Buyers' products. Buyers are responsible for their products and applications using TI components. To minimize the risks associated with Buyers' products and applications, Buyers should provide adequate design and operating safeguards.

TI does not warrant or represent that any license, either express or implied, is granted under any patent right, copyright, mask work right, or other intellectual property right relating to any combination, machine, or process in which TI components or services are used. Information published by TI regarding third-party products or services does not constitute a license to use such products or services or a warranty or endorsement thereof. Use of such information may require a license from a third party under the patents or other intellectual property of the third party, or a license from TI under the patents or other intellectual property of TI.

Reproduction of significant portions of TI information in TI data books or data sheets is permissible only if reproduction is without alteration and is accompanied by all associated warranties, conditions, limitations, and notices. TI is not responsible or liable for such altered documentation. Information of third parties may be subject to additional restrictions.

Resale of TI components or services with statements different from or beyond the parameters stated by TI for that component or service voids all express and any implied warranties for the associated TI component or service and is an unfair and deceptive business practice. TI is not responsible or liable for any such statements.

Buyer acknowledges and agrees that it is solely responsible for compliance with all legal, regulatory and safety-related requirements concerning its products, and any use of TI components in its applications, notwithstanding any applications-related information or support that may be provided by TI. Buyer represents and agrees that it has all the necessary expertise to create and implement safeguards which anticipate dangerous consequences of failures, monitor failures and their consequences, lessen the likelihood of failures that might cause harm and take appropriate remedial actions. Buyer will fully indemnify TI and its representatives against any damages arising out of the use of any TI components in safety-critical applications.

In some cases, TI components may be promoted specifically to facilitate safety-related applications. With such components, TI's goal is to help enable customers to design and create their own end-product solutions that meet applicable functional safety standards and requirements. Nonetheless, such components are subject to these terms.

No TI components are authorized for use in FDA Class III (or similar life-critical medical equipment) unless authorized officers of the parties have executed a special agreement specifically governing such use.

Only those TI components which TI has specifically designated as military grade or "enhanced plastic" are designed and intended for use in military/aerospace applications or environments. Buyer acknowledges and agrees that any military or aerospace use of TI components which have **not** been so designated is solely at the Buyer's risk, and that Buyer is solely responsible for compliance with all legal and regulatory requirements in connection with such use.

TI has specifically designated certain components as meeting ISO/TS16949 requirements, mainly for automotive use. In any case of use of non-designated products, TI will not be responsible for any failure to meet ISO/TS16949.

Products

| | |
|------------------------------|--|
| Audio | www.ti.com/audio |
| Amplifiers | amplifier.ti.com |
| Data Converters | dataconverter.ti.com |
| DLP® Products | www.dlp.com |
| DSP | dsp.ti.com |
| Clocks and Timers | www.ti.com/clocks |
| Interface | interface.ti.com |
| Logic | logic.ti.com |
| Power Mgmt | power.ti.com |
| Microcontrollers | microcontroller.ti.com |
| RFID | www.ti-rfid.com |
| OMAP Applications Processors | www.ti.com/omap |
| Wireless Connectivity | www.ti.com/wirelessconnectivity |

Applications

| | |
|-------------------------------|--|
| Automotive and Transportation | www.ti.com/automotive |
| Communications and Telecom | www.ti.com/communications |
| Computers and Peripherals | www.ti.com/computers |
| Consumer Electronics | www.ti.com/consumer-apps |
| Energy and Lighting | www.ti.com/energy |
| Industrial | www.ti.com/industrial |
| Medical | www.ti.com/medical |
| Security | www.ti.com/security |
| Space, Avionics and Defense | www.ti.com/space-avionics-defense |
| Video and Imaging | www.ti.com/video |

TI E2E Community

e2e.ti.com