

SINGLE-BIT DUAL-SUPPLY BUS TRANSCEIVER WITH CONFIGURABLE VOLTAGE TRANSLATION AND 3-STATE OUTPUTS

Check for Samples: [SN74LVC1T45-Q1](#)

FEATURES

- **Qualified for Automotive Applications**
- **Customer-Specific Configuration Control Can Be Supported Along With Major-Change Approval**
- **Fully Configurable Dual-Rail Design Allows Each Port to Operate Over the Full 1.65-V to 5.5-V Power-Supply Range**
- **V_{CC} Isolation Feature – If Either V_{CC} Input Is at GND, Both Ports Are in the High-Impedance State**
- **DIR Input Circuit Referenced to V_{CCA}**
- **± 24 -mA Output Drive at 3.3 V**
- **I_{off} Supports Partial-Power-Down Mode Operation**
- **Maximum Data Rates**
 - **420 Mbps (3.3-V to 5-V Translation)**
 - **210 Mbps (Translate to 3.3 V)**
 - **140 Mbps (Translate to 2.5 V)**
 - **75 Mbps (Translate to 1.8 V)**

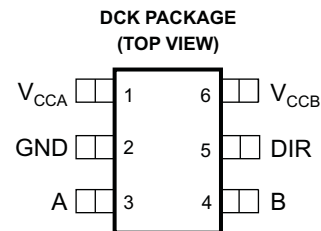

See mechanical drawings for dimensions.

DESCRIPTION/ORDERING INFORMATION

This single-bit noninverting bus transceiver uses two separate configurable power-supply rails. The A port is designed to track V_{CCA} . V_{CCA} accepts any supply voltage from 1.65 V to 5.5 V. The B port is designed to track V_{CCB} . V_{CCB} accepts any supply voltage from 1.65 V to 5.5 V. This allows for universal low-voltage bidirectional translation between any of the 1.8-V, 2.5-V, 3.3-V, and 5-V voltage nodes.

The SN74LVC1T45 is designed for asynchronous communication between two data buses. The logic levels of the direction-control (DIR) input activate either the B-port outputs or the A-port outputs. The device transmits data from the A bus to the B bus when the B-port outputs are activated and from the B bus to the A bus when the A-port outputs are activated. The input circuitry on both A and B ports always is active and must have a logic HIGH or LOW level applied to prevent excess I_{CC} and I_{CCZ} .

The SN74LVC1T45 is designed so that the DIR input is powered by V_{CCA} .

This device is fully specified for partial-power-down applications using I_{off} . The I_{off} circuitry disables the outputs, preventing damaging current backflow through the device when it is powered down.

The V_{CC} isolation feature ensures that if either V_{CC} input is at GND, then both ports are in the high-impedance state.

ORDERING INFORMATION⁽¹⁾

T _A	PACKAGE ⁽²⁾	ORDERABLE PART NUMBER	TOP-SIDE MARKING
–40°C to 105°C	SOT (SC-70) – DCK	Reel of 3000 SN74LVC1T45TDCKRQ1	5TR

(1) For the most current package and ordering information, see the Package Option Addendum at the end of this document, or see the TI web site at www.ti.com.

(2) Package drawings, thermal data, and symbolization are available at www.ti.com/packaging.



Please be aware that an important notice concerning availability, standard warranty, and use in critical applications of Texas Instruments semiconductor products and disclaimers thereto appears at the end of this data sheet.

FUNCTION TABLE⁽¹⁾

INPUT DIR	OPERATION
L	B data to A bus
H	A data to B bus

(1) Input circuits of the data I/Os always are active.

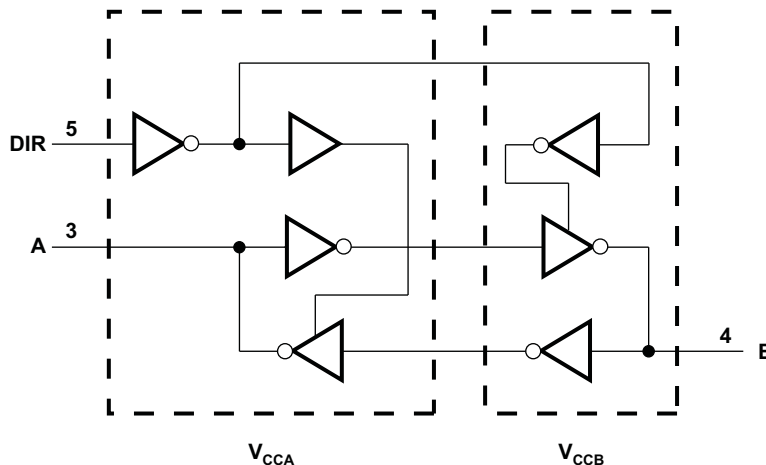
LOGIC DIAGRAM (POSITIVE LOGIC)**Absolute Maximum Ratings⁽¹⁾**

over operating free-air temperature range (unless otherwise noted)

		MIN	MAX	UNIT	
V_{CCA} V_{CCB}	Supply voltage range	-0.5	6.5	V	
V_I	Input voltage range ⁽²⁾	-0.5	6.5	V	
V_O	Voltage range applied to any output in the high-impedance or power-off state ⁽²⁾	-0.5	6.5	V	
V_O	Voltage range applied to any output in the high or low state ⁽²⁾ (3)	A port	-0.5	$V_{CCA} + 0.5$	V
		B port	-0.5	$V_{CCB} + 0.5$	
I_{IK}	Input clamp current		-50	mA	
I_{OK}	Output clamp current		-50	mA	
I_O	Continuous output current		±50	mA	
	Continuous current through V_{CC} or GND		±100	mA	
θ_{JA}	Package thermal impedance ⁽⁴⁾		259	°C/W	
	DCK package				
T_{stg}	Storage temperature range	-65	150	°C	

- (1) Stresses beyond those listed under "absolute maximum ratings" may cause permanent damage to the device. These are stress ratings only, and functional operation of the device at these or any other conditions beyond those indicated under "recommended operating conditions" is not implied. Exposure to absolute-maximum-rated conditions for extended periods may affect device reliability.
- (2) The input and output negative-voltage ratings may be exceeded if the input and output clamp-current ratings are observed.
- (3) The value of V_{CC} is provided in the recommended operating conditions table.
- (4) The package thermal impedance is calculated in accordance with JESD 51-7.

Recommended Operating Conditions^{(1) (2) (3)}

			V _{CCI}	V _{CCO}	MIN	MAX	UNIT
V _{CCA}	Supply voltage				1.65	5.5	V
V _{CCB}					1.65	5.5	
V _{IH}	High-level input voltage	Data inputs ⁽⁴⁾	1.65 V to 1.95 V		V _{CCI} × 0.65		V
			2.3 V to 2.7 V		1.7		
			3 V to 3.6 V		2		
			4.5 V to 5.5 V		V _{CCI} × 0.7		
V _{IL}	Low-level input voltage	Data inputs ⁽⁴⁾	1.65 V to 1.95 V		V _{CCI} × 0.35		V
			2.3 V to 2.7 V		0.7		
			3 V to 3.6 V		0.8		
			4.5 V to 5.5 V		V _{CCI} × 0.3		
V _{IH}	High-level input voltage	DIR (referenced to V _{CCA}) ⁽⁵⁾	1.65 V to 1.95 V		V _{CCA} × 0.65		V
			2.3 V to 2.7 V		1.7		
			3 V to 3.6 V		2		
			4.5 V to 5.5 V		V _{CCA} × 0.7		
V _{IL}	Low-level input voltage	DIR (referenced to V _{CCA}) ⁽⁵⁾	1.65 V to 1.95 V		V _{CCA} × 0.35		V
			2.3 V to 2.7 V		0.7		
			3 V to 3.6 V		0.8		
			4.5 V to 5.5 V		V _{CCA} × 0.3		
V _I	Input voltage				0	5.5	V
V _O	Output voltage				0	V _{CCO}	V
I _{OH}	High-level output current			1.65 V to 1.95 V		–4	mA
				2.3 V to 2.7 V		–8	
				3 V to 3.6 V		–24	
				4.5 V to 5.5 V		–32	
I _{OL}	Low-level output current			1.65 V to 1.95 V		4	mA
				2.3 V to 2.7 V		8	
				3 V to 3.6 V		24	
				4.5 V to 5.5 V		32	
Δt/Δv	Input transition rise or fall rate	Data inputs	1.65 V to 1.95 V			20	ns/V
			2.3 V to 2.7 V			20	
			3 V to 3.6 V			10	
			4.5 V to 5.5 V			5	
		Control inputs	1.65 V to 5.5 V			5	
T _A	Operating free-air temperature				–40	105	°C

(1) V_{CCI} is the V_{CC} associated with the input port.

(2) V_{CCO} is the V_{CC} associated with the output port.

(3) All unused data inputs of the device must be held at V_{CCI} or GND to ensure proper device operation. Refer to the TI application report, *Implications of Slow or Floating CMOS Inputs*, literature number SCBA004.

(4) For V_{CCI} values not specified in the data sheet, V_{IH} min = V_{CCI} × 0.7 V, V_{IL} max = V_{CCI} × 0.3 V.

(5) For V_{CCI} values not specified in the data sheet, V_{IH} min = V_{CCA} × 0.7 V, V_{IL} max = V_{CCA} × 0.3 V.

Electrical Characteristics^{(1) (2)}

over recommended operating free-air temperature range (unless otherwise noted)

PARAMETER	TEST CONDITIONS	V _{CCA}	V _{CCB}	T _A = 25°C			T _A = -40°C to 105°C		UNIT	
				MIN	TYP	MAX	MIN	MAX		
V _{OH}	I _{OH} = -100 μA I _{OH} = -4 mA I _{OH} = -8 mA I _{OH} = -24 mA I _{OH} = -32 mA	V _I = V _{IH}	1.65 V to 4.5 V	1.65 V to 4.5 V				V _{CCO} - 0.1	V	
			1.65 V	1.65 V			1.2			
			2.3 V	2.3 V			1.9			
			3 V	3 V			2.3			
			4.5 V	4.5 V			3.8			
V _{OL}	I _{OL} = 100 μA I _{OL} = 4 mA I _{OL} = 8 mA I _{OL} = 24 mA I _{OL} = 32 mA	V _I = V _{IL}	1.65 V to 4.5 V	1.65 V to 4.5 V				0.1	V	
			1.65 V	1.65 V			0.45			
			2.3 V	2.3 V			0.4			
			3 V	3 V			0.65			
			4.5 V	4.5 V			0.65			
I _I	DIR	V _I = V _{CCA} or GND	1.65 V to 5.5 V	1.65 V to 5.5 V			±1	±4	μA	
I _{off}	A port	V _I or V _O = 0 to 5.5 V	0 V	0 to 5.5 V			±1	±10	μA	
	B port		0 to 5.5 V	0 V			±1	±10		
I _{OZ}	A or B port	V _O = V _{CCO} or GND	1.65 V to 5.5 V	1.65 V to 5.5 V			±1	±10	μA	
I _{CCA}	V _I = V _{CCI} or GND, I _O = 0	1.65 V to 5.5 V	1.65 V to 5.5 V					10	μA	
		5.5 V	0 V					4		
		0 V	5.5 V					-10		
I _{CCB}	V _I = V _{CCI} or GND, I _O = 0	1.65 V to 5.5 V	1.65 V to 5.5 V					10	μA	
		5.5 V	0 V					-10		
		0 V	5.5 V					4		
I _{CCA} + I _{CCB}	V _I = V _{CCI} or GND, I _O = 0	1.65 V to 5.5 V	1.65 V to 5.5 V					20	μA	
ΔI _{CCA}	A port	A port at V _{CCA} - 0.6 V, DIR at V _{CCA} , B port = open	3 V to 5.5 V	3 V to 5.5 V					50	μA
	DIR	DIR at V _{CCA} - 0.6 V, B port = open, A port at V _{CCA} or GND							50	
ΔI _{CCB}	B port	B port at V _{CCB} - 0.6 V, DIR at GND, A port = open	3 V to 5.5 V	3 V to 5.5 V					50	μA
C _i	DIR	V _I = V _{CCA} or GND	3.3 V	3.3 V		2.5				pF
C _{io}	A or B port	V _O = V _{CCA/B} or GND	3.3 V	3.3 V		6				pF

(1) V_{CCO} is the V_{CC} associated with the output port.(2) V_{CCI} is the V_{CC} associated with the input port.

Switching Characteristics

over recommended operating free-air temperature range, $V_{CCA} = 1.8\text{ V} \pm 0.15\text{ V}$ (see [Figure 1](#))

PARAMETER	FROM (INPUT)	TO (OUTPUT)	$V_{CCB} = 1.8\text{ V} \pm 0.15\text{ V}$		$V_{CCB} = 2.5\text{ V} \pm 0.2\text{ V}$		$V_{CCB} = 3.3\text{ V} \pm 0.3\text{ V}$		$V_{CCB} = 5\text{ V} \pm 0.5\text{ V}$		UNIT
			MIN	MAX	MIN	MAX	MIN	MAX	MIN	MAX	
t_{PLH}	A	B	3	20.7	2.2	13.3	1.7	11.3	1.4	10.2	ns
t_{PHL}			2.8	17.3	2.2	11.5	1.8	10.1	1.7	10	
t_{PLH}	B	A	3	20.7	2.3	19	2.1	18.5	1.9	18.1	ns
t_{PHL}			2.8	17.3	2.1	15.9	2	15.6	1.8	15.2	
t_{PHZ}	DIR	A	5.2	22.7	4.8	21.5	4.7	21.4	5.1	20.1	ns
t_{PLZ}			2.3	13.5	2.1	13.5	2.4	13.7	3.1	13.9	
t_{PHZ}	DIR	B	7.4	27.9	4.9	14.5	3.6	13.3	2.3	11.2	ns
t_{PLZ}			4.2	19	2.2	12.2	2.3	11.4	2.0	9.4	
$t_{PZH}^{(1)}$	DIR	A		39.7		31.2		29.9		27.5	ns
$t_{PZL}^{(1)}$				45.2		30.4		28.9		26.4	
$t_{PZH}^{(1)}$	DIR	B		34.2		26.8		25		24.1	ns
$t_{PZL}^{(1)}$				40.7		33		31.5		30.1	

(1) The enable time is a calculated value, derived using the formula shown in the *enable times* section.

Switching Characteristics

over recommended operating free-air temperature range, $V_{CCA} = 2.5\text{ V} \pm 0.2\text{ V}$ (see [Figure 1](#))

PARAMETER	FROM (INPUT)	TO (OUTPUT)	$V_{CCB} = 1.8\text{ V} \pm 0.15\text{ V}$		$V_{CCB} = 2.5\text{ V} \pm 0.2\text{ V}$		$V_{CCB} = 3.3\text{ V} \pm 0.3\text{ V}$		$V_{CCB} = 5\text{ V} \pm 0.5\text{ V}$		UNIT
			MIN	MAX	MIN	MAX	MIN	MAX	MIN	MAX	
t_{PLH}	A	B	2.3	19	1.5	11.5	1.3	9.4	1.1	8.1	ns
t_{PHL}			2.1	15.9	1.4	10.5	1.3	8.4	0.9	7.6	
t_{PLH}	B	A	2.2	13.3	1.5	11.5	1.4	11	1	10.5	ns
t_{PHL}			2.2	11.5	1.4	10.7	1.3	10	0.9	9.2	
t_{PHZ}	DIR	A	3	11.1	2.1	11.1	2.3	11.1	3.2	11.1	ns
t_{PLZ}			1.3	8.9	1.3	8.9	1.3	8.9	1	8.8	
t_{PHZ}	DIR	B	6.5	26.7	4.1	14.4	3.0	13.2	1.9	10.1	ns
t_{PLZ}			3.5	21.9	2.2	12.6	2.5	11.4	1.6	8.3	
$t_{PZH}^{(1)}$	DIR	A		35.2		24.1		22.4		18.8	ns
$t_{PZL}^{(1)}$				38.2		24.9		23.2		19.3	
$t_{PZH}^{(1)}$	DIR	B		27.9		20.4		18.3		16.9	ns
$t_{PZL}^{(1)}$				27		21.6		19.5		18.7	

(1) The enable time is a calculated value, derived using the formula shown in the *enable times* section.

Switching Characteristics

over recommended operating free-air temperature range, $V_{CCA} = 3.3 \text{ V} \pm 0.3 \text{ V}$ (see [Figure 1](#))

PARAMETER	FROM (INPUT)	TO (OUTPUT)	$V_{CCB} = 1.8 \text{ V}$ $\pm 0.15 \text{ V}$		$V_{CCB} = 2.5 \text{ V}$ $\pm 0.2 \text{ V}$		$V_{CCB} = 3.3 \text{ V}$ $\pm 0.3 \text{ V}$		$V_{CCB} = 5 \text{ V}$ $\pm 0.5 \text{ V}$		UNIT
			MIN	MAX	MIN	MAX	MIN	MAX	MIN	MAX	
t_{PLH}	A	B	2.1	18.5	1.4	11	0.7	8.8	0.7	7.4	ns
t_{PHL}			2	15.6	1.3	10	0.8	8	0.7	7	
t_{PLH}	B	A	1.7	11.3	1.3	9.4	0.7	8.8	0.6	8.4	ns
t_{PHL}			1.8	10.1	1.3	8.4	0.8	8	0.7	7.5	
t_{PHZ}	DIR	A	2.3	10.3	2.4	10.3	1.5	10.3	2.4	10.3	ns
t_{PLZ}			1.8	8.6	1.6	8.6	1.9	8.7	2.0	8.7	
t_{PHZ}	DIR	B	5.4	27.5	3.9	13.1	2.9	11.8	1.7	9.8	ns
t_{PLZ}			2.3	17.5	2.1	10.8	2.4	10.1	1.5	7.9	
$t_{PZH}^{(1)}$	DIR	A		28.8		20.2		18.9		16.3	ns
$t_{PZL}^{(1)}$				37.6		21.5		19.8		17.3	
$t_{PZH}^{(1)}$	DIR	B		27.1		19.6		17.5		16.1	ns
$t_{PZL}^{(1)}$				25.9		20.3		18.3		17.3	

(1) The enable time is a calculated value, derived using the formula shown in the *enable times* section.

Switching Characteristics

over recommended operating free-air temperature range, $V_{CCA} = 5 \text{ V} \pm 0.5 \text{ V}$ (see [Figure 1](#))

PARAMETER	FROM (INPUT)	TO (OUTPUT)	$V_{CCB} = 1.8 \text{ V}$ $\pm 0.15 \text{ V}$		$V_{CCB} = 2.5 \text{ V}$ $\pm 0.2 \text{ V}$		$V_{CCB} = 3.3 \text{ V}$ $\pm 0.3 \text{ V}$		$V_{CCB} = 5 \text{ V}$ $\pm 0.5 \text{ V}$		UNIT
			MIN	MAX	MIN	MAX	MIN	MAX	MIN	MAX	
t_{PLH}	A	B	1.9	18.1	1	10.5	0.6	8.4	0.5	6.9	ns
t_{PHL}			1.8	15.2	0.9	9.2	0.7	7.5	0.5	6.5	
t_{PLH}	B	A	1.4	10.2	1	8.1	0.7	7.4	0.5	6.9	ns
t_{PHL}			1.7	10	0.9	7.6	0.7	7	0.5	6.5	
t_{PHZ}	DIR	A	2.1	8.4	2.0	8.4	2.2	8.5	2.0	8.4	ns
t_{PLZ}			0.9	6.8	1	6.8	1	6.7	0.9	6.7	
t_{PHZ}	DIR	B	4.8	26.2	2.5	14.8	1	11.5	1.7	9.5	ns
t_{PLZ}			2.6	17.8	2.0	10.4	2.5	10	1.6	7.5	
$t_{PZH}^{(1)}$	DIR	A		28		18.5		17.4		14.4	ns
$t_{PZL}^{(1)}$				36.2		22.4		18.5		16	
$t_{PZH}^{(1)}$	DIR	B		24.9		17.3		15.1		13.6	ns
$t_{PZL}^{(1)}$				23.6		17.6		16		14.9	

(1) The enable time is a calculated value, derived using the formula shown in the *enable times* section.

Operating Characteristics

 $T_A = 25^\circ\text{C}$

PARAMETER		TEST CONDITIONS	$V_{CCA} =$ $V_{CCB} = 1.8\text{ V}$	$V_{CCA} =$ $V_{CCB} = 2.5\text{ V}$	$V_{CCA} =$ $V_{CCB} = 3.3\text{ V}$	$V_{CCA} =$ $V_{CCB} = 5\text{ V}$	UNIT
			TYP	TYP	TYP	TYP	
C_{pdA} (1)	A-port input, B-port output	$C_L = 0\text{ pF}$, $f = 10\text{ MHz}$, $t_r = t_f = 1\text{ ns}$	3	4	4	4	pF
	B-port input, A-port output		18	19	20	21	
C_{pdB} (1)	A-port input, B-port output	$C_L = 0\text{ pF}$, $f = 10\text{ MHz}$, $t_r = t_f = 1\text{ ns}$	18	19	20	21	pF
	B-port input, A-port output		3	4	4	4	

(1) Power dissipation capacitance per transceiver

Power-Up Considerations

A proper power-up sequence always should be followed to avoid excessive supply current, bus contention, oscillations, or other anomalies. To guard against such power-up problems, take the following precautions:

1. Connect ground before any supply voltage is applied.
2. Power up V_{CCA} .
3. V_{CCB} can be ramped up along with or after V_{CCA} .

TYPICAL CHARACTERISTICS

TYPICAL PROPAGATION DELAY (A to B) vs LOAD CAPACITANCE
 $T_A = 25^\circ\text{C}, V_{CCA} = 1.8\text{ V}$

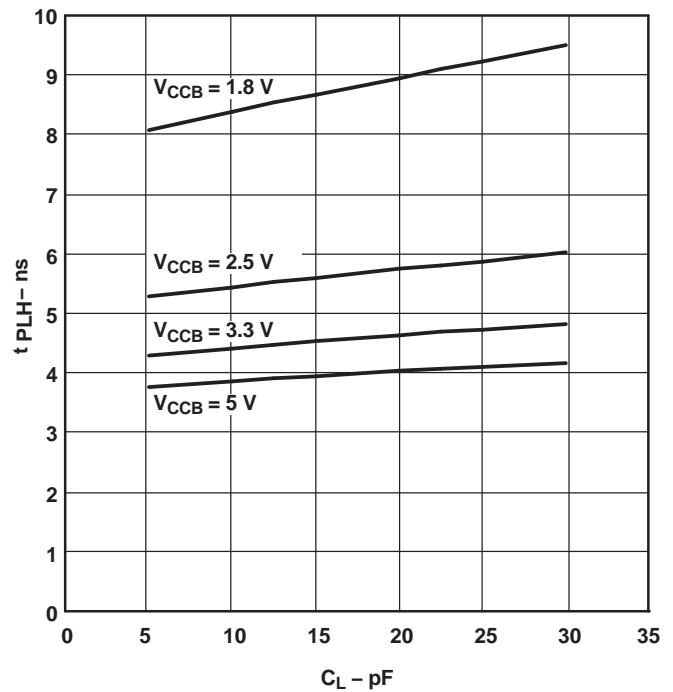
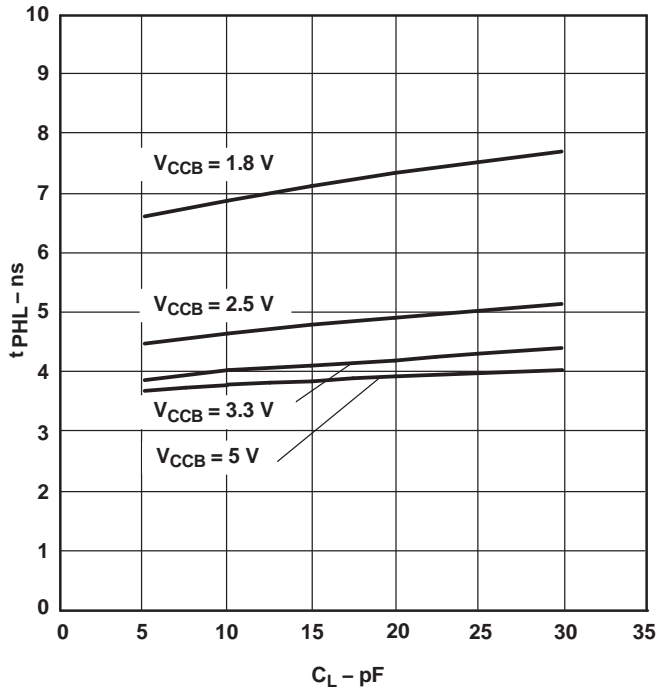

TYPICAL PROPAGATION DELAY (B to A) vs LOAD CAPACITANCE
 $T_A = 25^\circ\text{C}, V_{CCA} = 1.8\text{ V}$

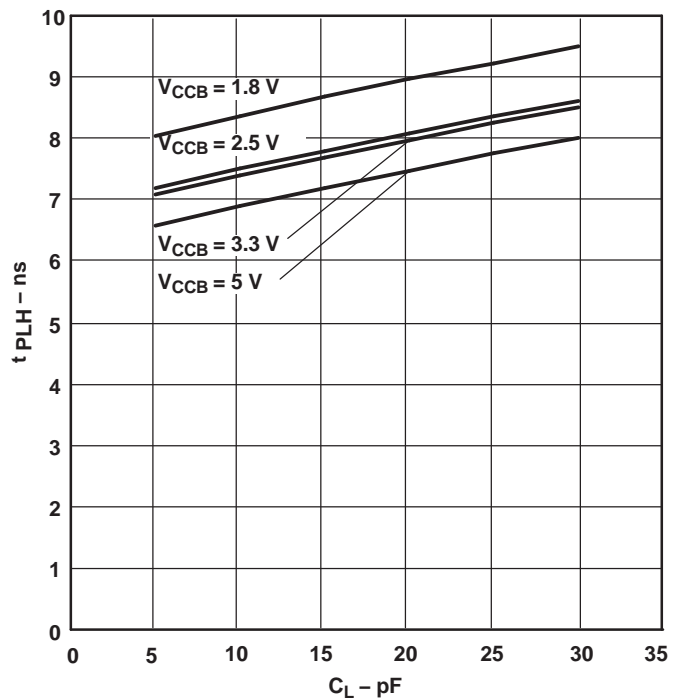
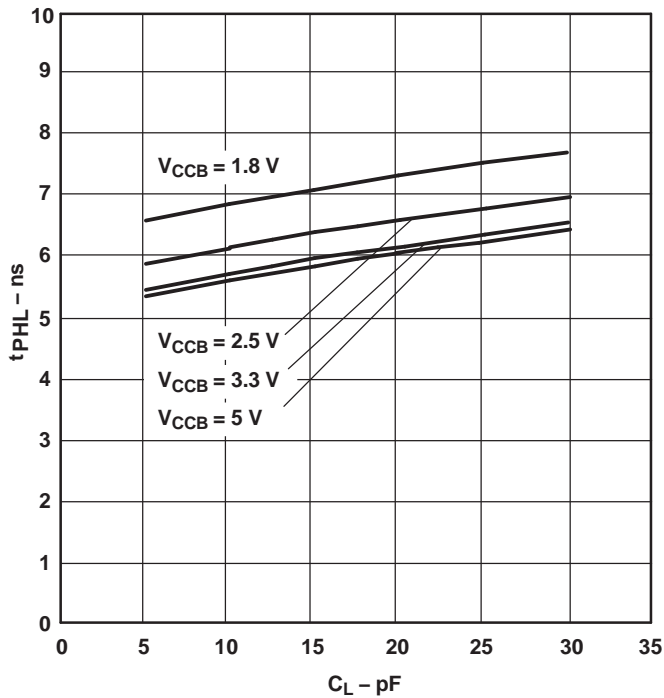

TYPICAL CHARACTERISTICS (continued)
TYPICAL PROPAGATION DELAY (A to B) vs LOAD CAPACITANCE
 $T_A = 25^\circ\text{C}, V_{CCA} = 2.5\text{ V}$

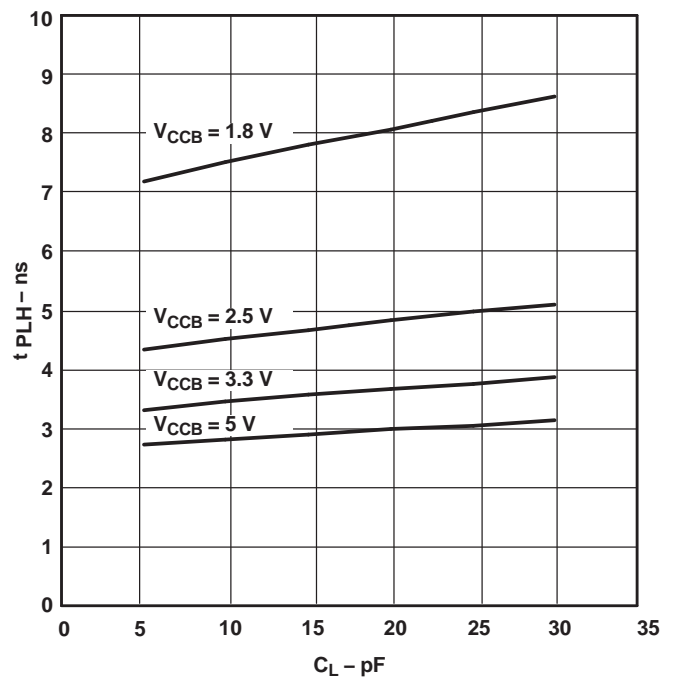
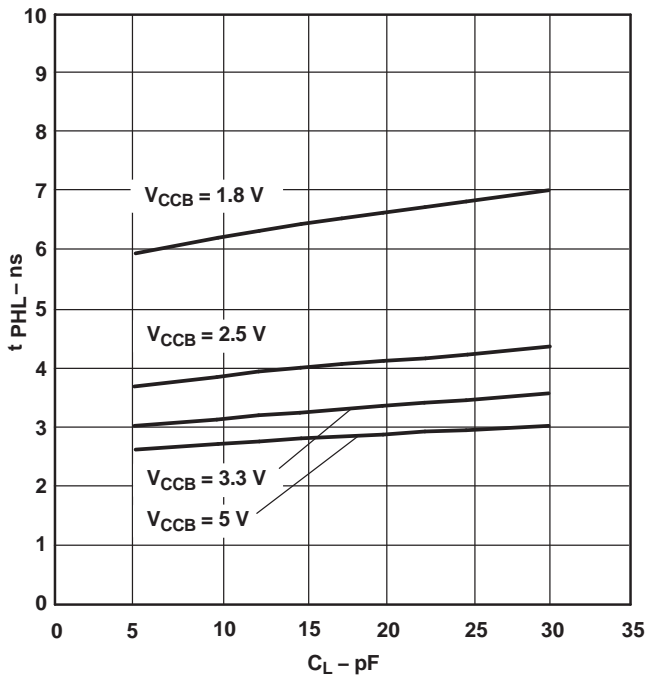

TYPICAL PROPAGATION DELAY (B to A) vs LOAD CAPACITANCE
 $T_A = 25^\circ\text{C}, V_{CCA} = 2.5\text{ V}$

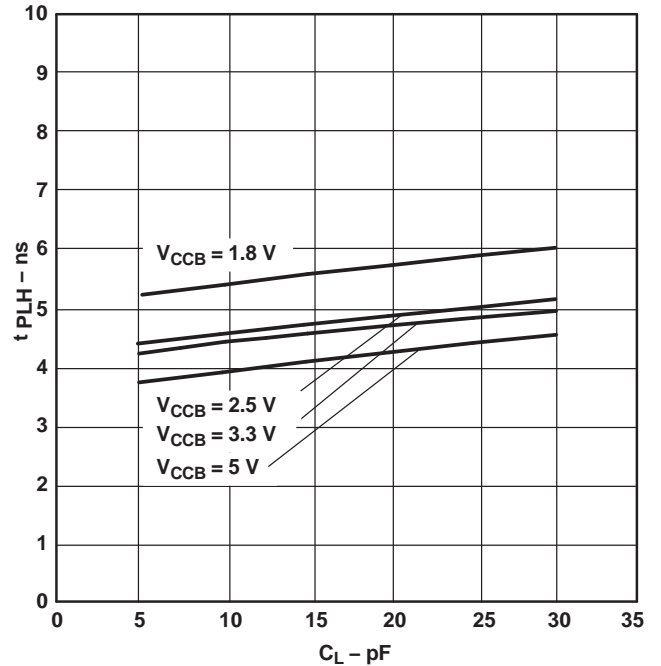
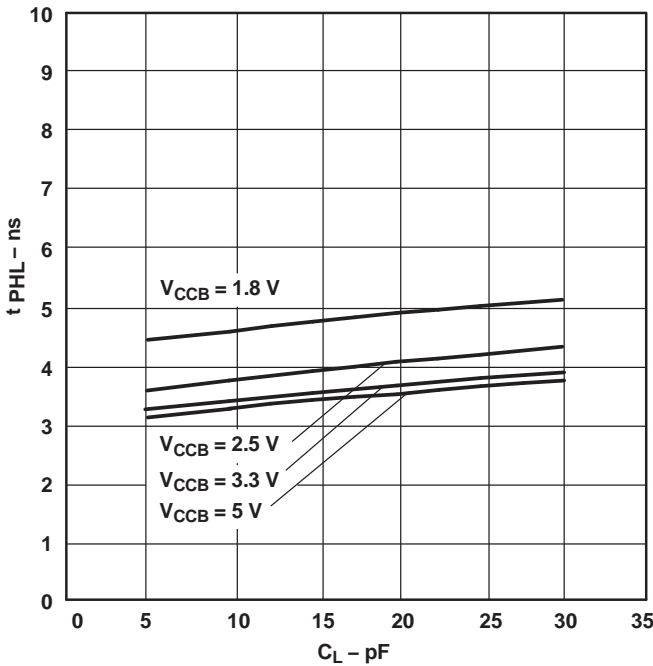

TYPICAL CHARACTERISTICS (continued)
TYPICAL PROPAGATION DELAY (A to B) vs LOAD CAPACITANCE
 $T_A = 25^\circ\text{C}, V_{CCA} = 3.3\text{ V}$

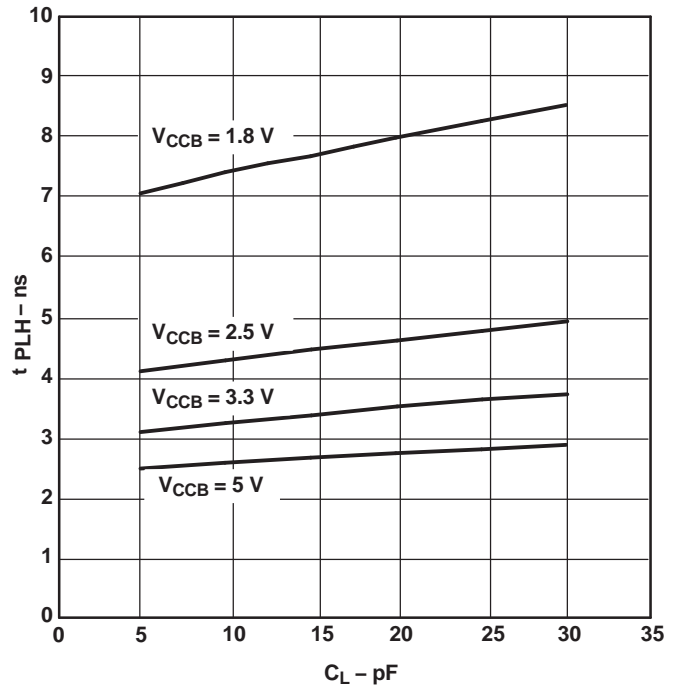
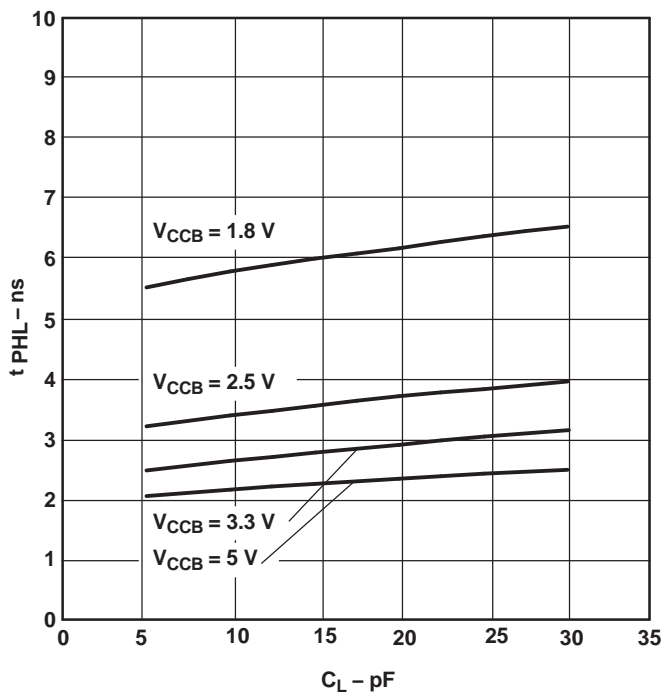

TYPICAL PROPAGATION DELAY (B to A) vs LOAD CAPACITANCE
 $T_A = 25^\circ\text{C}, V_{CCA} = 3.3\text{ V}$

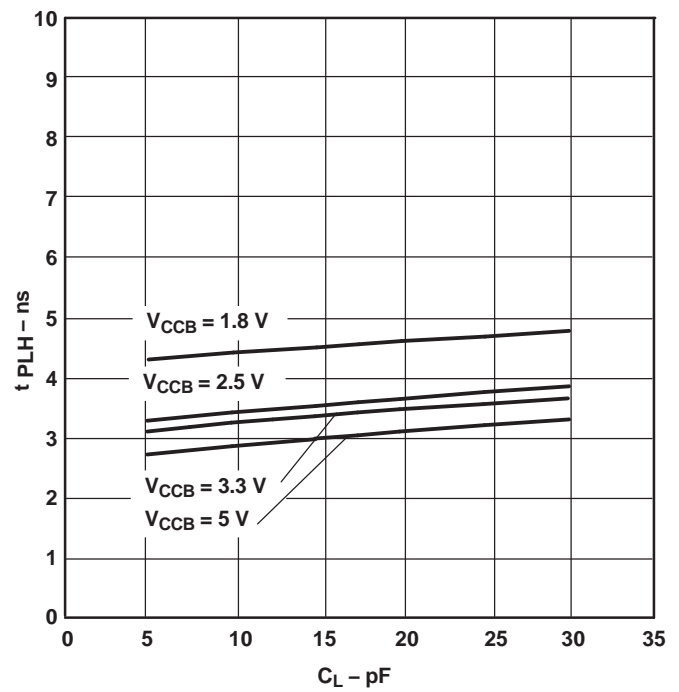
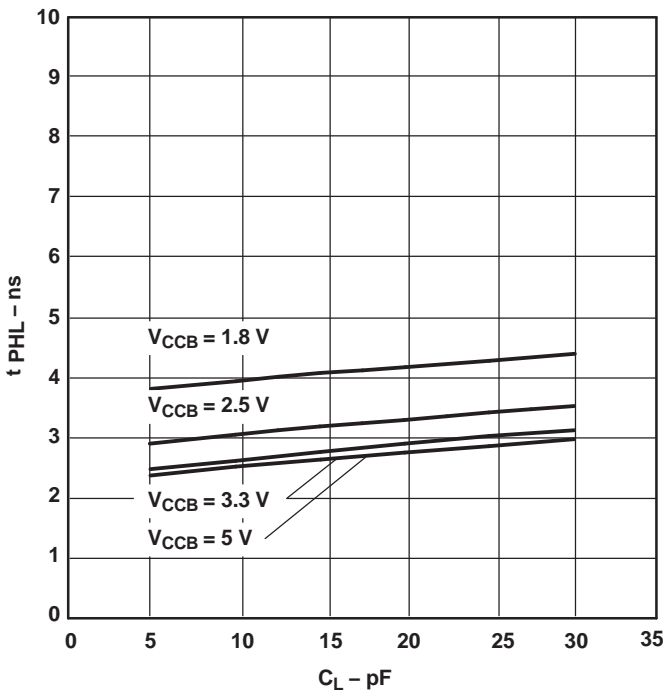

TYPICAL CHARACTERISTICS (continued)
TYPICAL PROPAGATION DELAY (A to B) vs LOAD CAPACITANCE
 $T_A = 25^\circ\text{C}, V_{CCA} = 5\text{ V}$

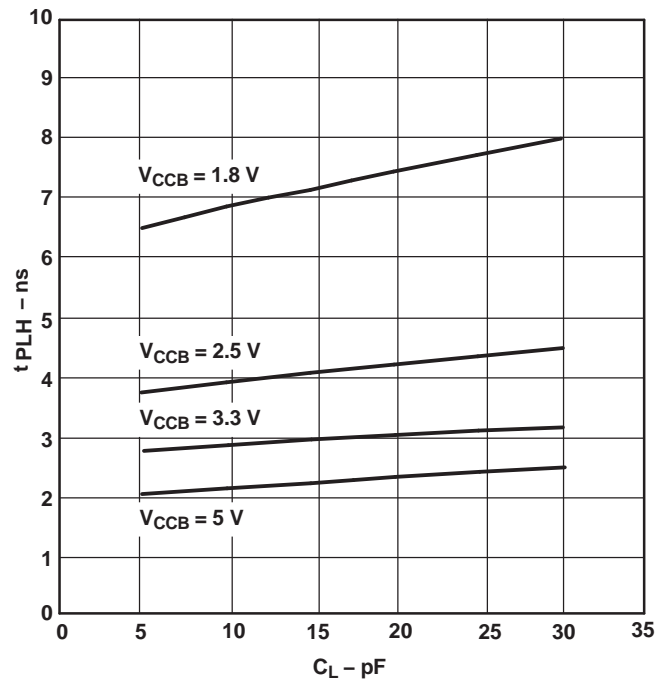
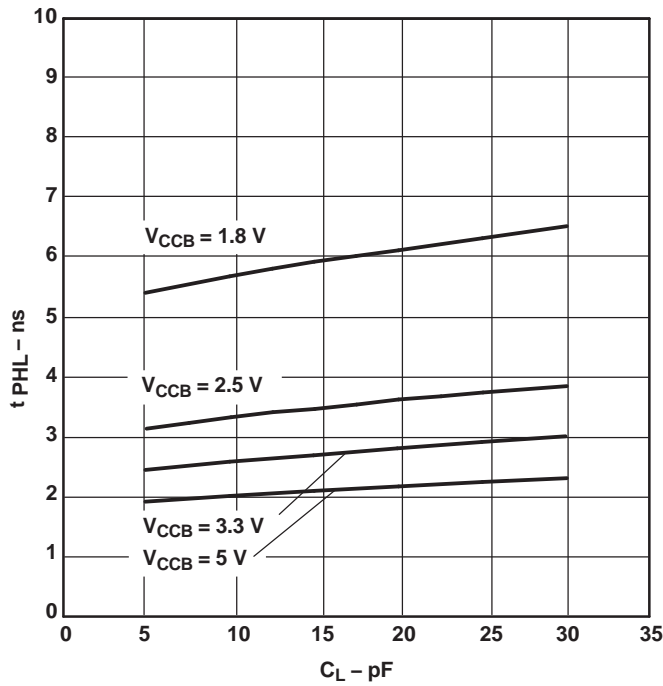

TYPICAL PROPAGATION DELAY (B to A) vs LOAD CAPACITANCE
 $T_A = 25^\circ\text{C}, V_{CCA} = 5\text{ V}$

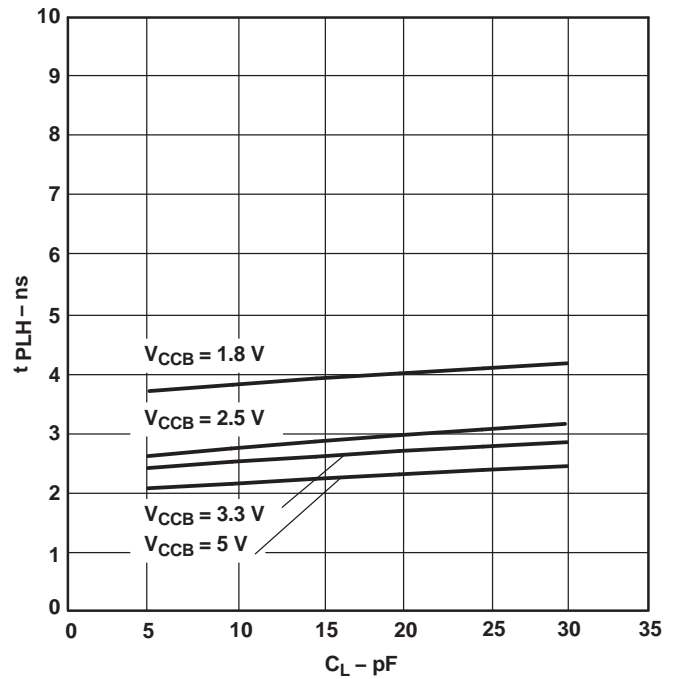
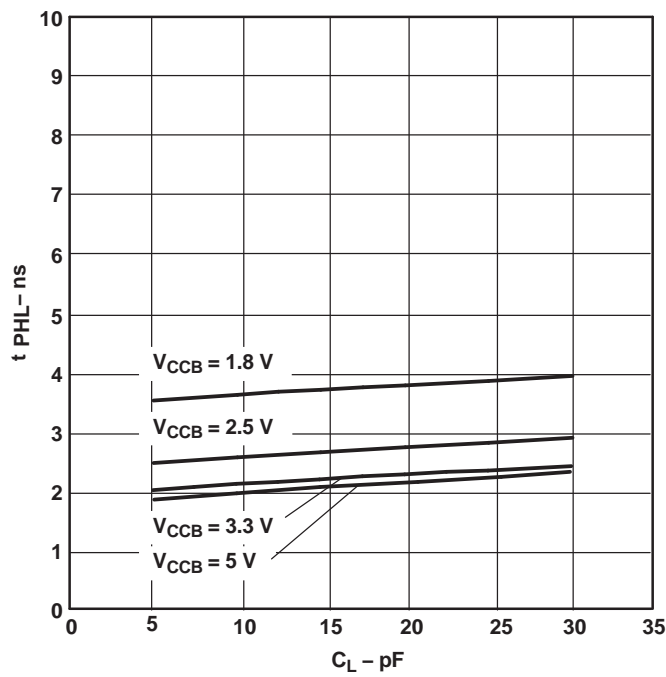

PARAMETER MEASUREMENT INFORMATION

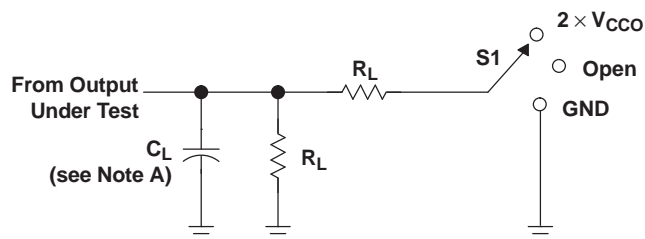

LOAD CIRCUIT

TEST	S1
t_{pd}	Open
t_{PLZ}/t_{PZL}	$2 \times V_{CCO}$
t_{PHZ}/t_{PZH}	GND

V_{CCO}	C_L	R_L	V_{TP}
$1.8\text{ V} \pm 0.15\text{ V}$	15 pF	2 k Ω	0.15 V
$2.5\text{ V} \pm 0.2\text{ V}$	15 pF	2 k Ω	0.15 V
$3.3\text{ V} \pm 0.3\text{ V}$	15 pF	2 k Ω	0.3 V
$5\text{ V} \pm 0.5\text{ V}$	15 pF	2 k Ω	0.3 V

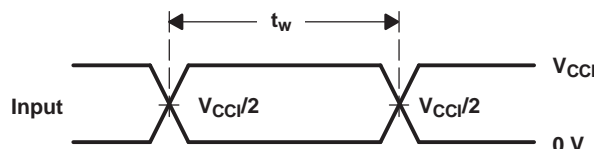

VOLTAGE WAVEFORMS PULSE DURATION

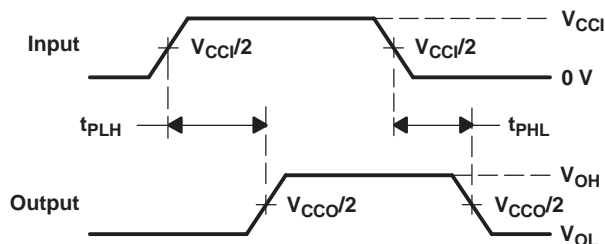

VOLTAGE WAVEFORMS PROPAGATION DELAY TIMES

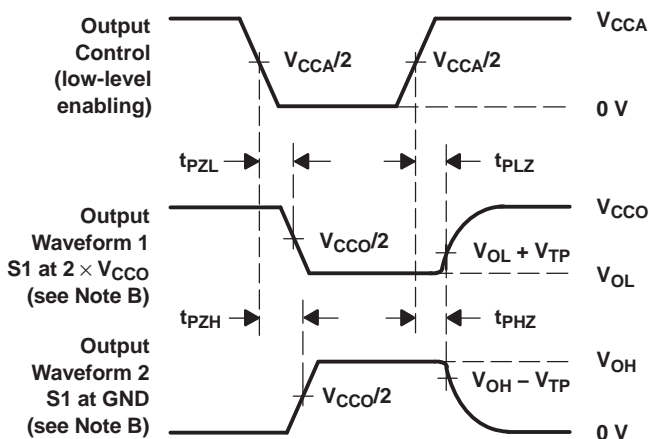

VOLTAGE WAVEFORMS ENABLE AND DISABLE TIMES

- NOTES:
- A. C_L includes probe and jig capacitance.
 - B. Waveform 1 is for an output with internal conditions such that the output is low, except when disabled by the output control. Waveform 2 is for an output with internal conditions such that the output is high, except when disabled by the output control.
 - C. All input pulses are supplied by generators having the following characteristics: PRR \leq 10 MHz, $Z_O = 50\ \Omega$, $dv/dt \geq 1\text{ V/ns}$.
 - D. The outputs are measured one at a time, with one transition per measurement.
 - E. t_{PLZ} and t_{PHZ} are the same as t_{dis} .
 - F. t_{PZL} and t_{PZH} are the same as t_{en} .
 - G. t_{PLH} and t_{PHL} are the same as t_{pd} .
 - H. V_{CCI} is the V_{CC} associated with the input port.
 - I. V_{CCO} is the V_{CC} associated with the output port.
 - J. All parameters and waveforms are not applicable to all devices.

Figure 1. Load Circuit and Voltage Waveforms

APPLICATION INFORMATION

Figure 2 shows an example of the SN74LVC1T45 being used in a unidirectional logic level-shifting application.

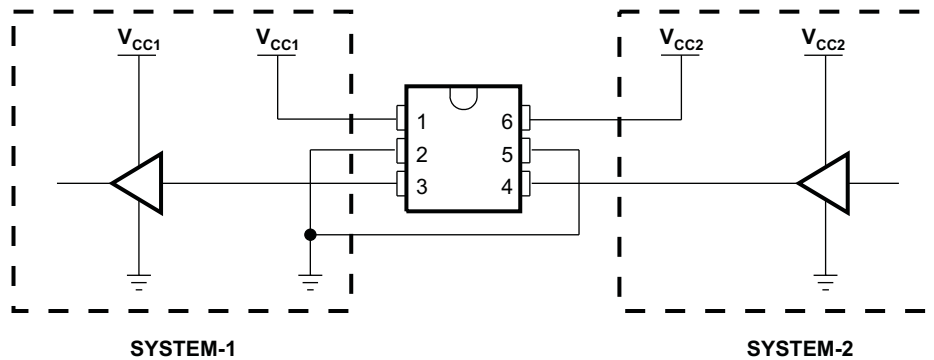

PIN	NAME	FUNCTION	DESCRIPTION
1	V _{CCA}	V _{CC1}	SYSTEM-1 supply voltage (1.65 V to 5.5 V)
2	GND	GND	Device GND
3	A	OUT	Output level depends on V _{CC1} voltage.
4	B	IN	Input threshold value depends on V _{CC2} voltage.
5	DIR	DIR	GND (low level) determines B-port to A-port direction.
6	V _{CCB}	V _{CC2}	SYSTEM-2 supply voltage (1.65 V to 5.5 V)

Figure 2. Unidirectional Logic Level-Shifting Application

Figure 3 shows the SN74LVC1T45 being used in a bidirectional logic level-shifting application. Since the SN74LVC1T45 does not have an output-enable (OE) pin, the system designer should take precautions to avoid bus contention between SYSTEM-1 and SYSTEM-2 when changing directions.

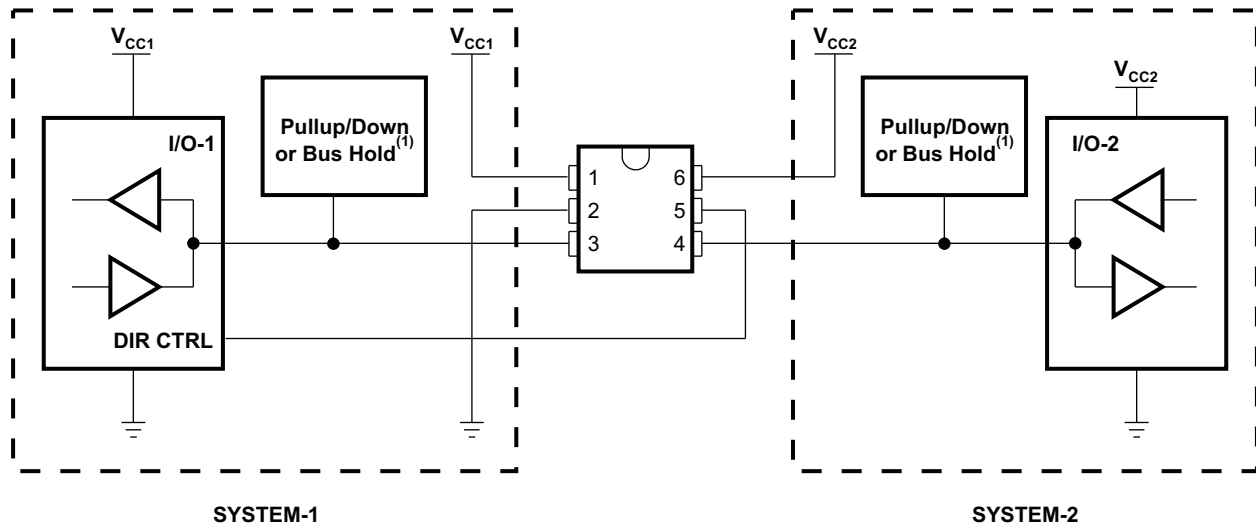

The following table shows data transmission from SYSTEM-1 to SYSTEM-2 and then from SYSTEM-2 to SYSTEM-1.

STATE	DIR CTRL	I/O-1	I/O-2	DESCRIPTION
1	H	Out	In	SYSTEM-1 data to SYSTEM-2
2	H	Hi-Z	Hi-Z	SYSTEM-2 is getting ready to send data to SYSTEM-1. I/O-1 and I/O-2 are disabled. The bus-line state depends on pullup or pulldown. ⁽¹⁾
3	L	Hi-Z	Hi-Z	DIR bit is flipped. I/O-1 and I/O-2 still are disabled. The bus-line state depends on pullup or pulldown. ⁽¹⁾
4	L	Out	In	SYSTEM-2 data to SYSTEM-1

(1) SYSTEM-1 and SYSTEM-2 must use the same conditions, i.e., both pullup or both pulldown.

Figure 3. Bidirectional Logic Level-Shifting Application

Enable Times

Calculate the enable times for the SN74LVC1T45 using the following formulas:

- $t_{PZH} \text{ (DIR to A)} = t_{PLZ} \text{ (DIR to B)} + t_{PLH} \text{ (B to A)}$
- $t_{PZL} \text{ (DIR to A)} = t_{PHZ} \text{ (DIR to B)} + t_{PHL} \text{ (B to A)}$
- $t_{PZH} \text{ (DIR to B)} = t_{PLZ} \text{ (DIR to A)} + t_{PLH} \text{ (A to B)}$
- $t_{PZL} \text{ (DIR to B)} = t_{PHZ} \text{ (DIR to A)} + t_{PHL} \text{ (A to B)}$

In a bidirectional application, these enable times provide the maximum delay from the time the DIR bit is switched until an output is expected. For example, if the SN74LVC1T45 initially is transmitting from A to B, then the DIR bit is switched; the B port of the device must be disabled before presenting it with an input. After the B port has been disabled, an input signal applied to it appears on the corresponding A port after the specified propagation delay.

PACKAGING INFORMATION

Orderable Device	Status ⁽¹⁾	Package Type	Package Drawing	Pins	Package Qty	Eco Plan ⁽²⁾	Lead/ Ball Finish	MSL Peak Temp ⁽³⁾	Samples (Requires Login)
SN74LVC1T45QDCKRQ1	ACTIVE	SC70	DCK	6	3000	Green (RoHS & no Sb/Br)	CU NIPDAU	Level-1-260C-UNLIM	

⁽¹⁾ The marketing status values are defined as follows:

ACTIVE: Product device recommended for new designs.

LIFEBUY: TI has announced that the device will be discontinued, and a lifetime-buy period is in effect.

NRND: Not recommended for new designs. Device is in production to support existing customers, but TI does not recommend using this part in a new design.

PREVIEW: Device has been announced but is not in production. Samples may or may not be available.

OBSOLETE: TI has discontinued the production of the device.

⁽²⁾ Eco Plan - The planned eco-friendly classification: Pb-Free (RoHS), Pb-Free (RoHS Exempt), or Green (RoHS & no Sb/Br) - please check <http://www.ti.com/productcontent> for the latest availability information and additional product content details.

TBD: The Pb-Free/Green conversion plan has not been defined.

Pb-Free (RoHS): TI's terms "Lead-Free" or "Pb-Free" mean semiconductor products that are compatible with the current RoHS requirements for all 6 substances, including the requirement that lead not exceed 0.1% by weight in homogeneous materials. Where designed to be soldered at high temperatures, TI Pb-Free products are suitable for use in specified lead-free processes.

Pb-Free (RoHS Exempt): This component has a RoHS exemption for either 1) lead-based flip-chip solder bumps used between the die and package, or 2) lead-based die adhesive used between the die and leadframe. The component is otherwise considered Pb-Free (RoHS compatible) as defined above.

Green (RoHS & no Sb/Br): TI defines "Green" to mean Pb-Free (RoHS compatible), and free of Bromine (Br) and Antimony (Sb) based flame retardants (Br or Sb do not exceed 0.1% by weight in homogeneous material)

⁽³⁾ MSL, Peak Temp. -- The Moisture Sensitivity Level rating according to the JEDEC industry standard classifications, and peak solder temperature.

Important Information and Disclaimer: The information provided on this page represents TI's knowledge and belief as of the date that it is provided. TI bases its knowledge and belief on information provided by third parties, and makes no representation or warranty as to the accuracy of such information. Efforts are underway to better integrate information from third parties. TI has taken and continues to take reasonable steps to provide representative and accurate information but may not have conducted destructive testing or chemical analysis on incoming materials and chemicals. TI and TI suppliers consider certain information to be proprietary, and thus CAS numbers and other limited information may not be available for release.

In no event shall TI's liability arising out of such information exceed the total purchase price of the TI part(s) at issue in this document sold by TI to Customer on an annual basis.

OTHER QUALIFIED VERSIONS OF SN74LVC1T45-Q1 :

● Catalog: [SN74LVC1T45](#)

● Enhanced Product: [SN74LVC1T45-EP](#)

NOTE: Qualified Version Definitions:

- Catalog - TI's standard catalog product
- Enhanced Product - Supports Defense, Aerospace and Medical Applications

TAPE AND REEL INFORMATION



QUADRANT ASSIGNMENTS FOR PIN 1 ORIENTATION IN TAPE



*All dimensions are nominal

Device	Package Type	Package Drawing	Pins	SPQ	Reel Diameter (mm)	Reel Width W1 (mm)	A0 (mm)	B0 (mm)	K0 (mm)	P1 (mm)	W (mm)	Pin1 Quadrant
SN74LVC1T45QDCKRQ1	SC70	DCK	6	3000	180.0	8.4	2.25	2.4	1.22	4.0	8.0	Q3

TAPE AND REEL BOX DIMENSIONS



*All dimensions are nominal

Device	Package Type	Package Drawing	Pins	SPQ	Length (mm)	Width (mm)	Height (mm)
SN74LVC1T45QDCKRQ1	SC70	DCK	6	3000	202.0	201.0	28.0

DCK (R-PDSO-G6)

PLASTIC SMALL-OUTLINE PACKAGE

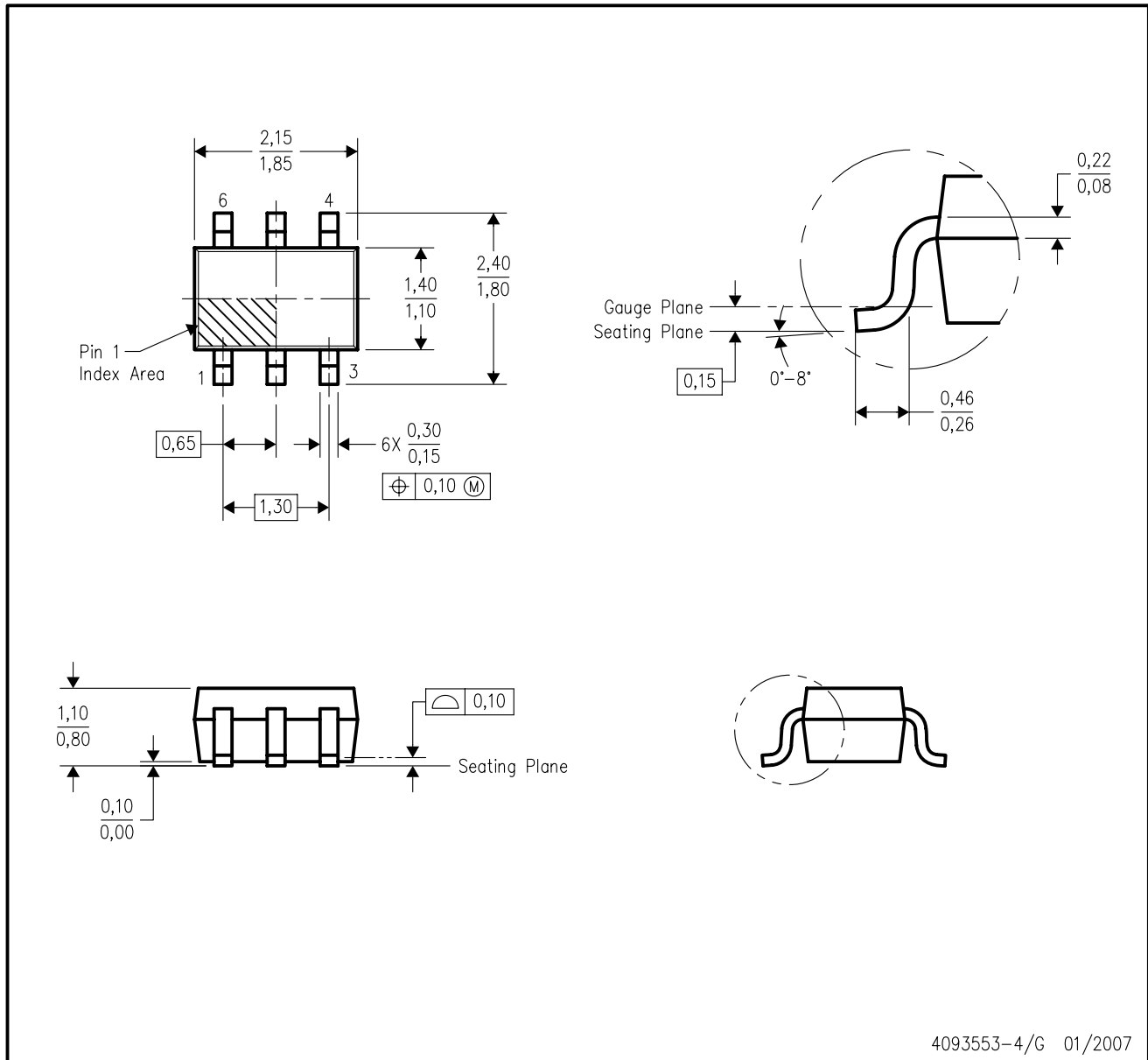

- NOTES:
- A. All linear dimensions are in millimeters.
 - B. This drawing is subject to change without notice.
 - C. Body dimensions do not include mold flash or protrusion. Mold flash and protrusion shall not exceed 0.15 per side.
 - D. Falls within JEDEC MO-203 variation AB.

IMPORTANT NOTICE

Texas Instruments Incorporated and its subsidiaries (TI) reserve the right to make corrections, enhancements, improvements and other changes to its semiconductor products and services per JESD46, latest issue, and to discontinue any product or service per JESD48, latest issue. Buyers should obtain the latest relevant information before placing orders and should verify that such information is current and complete. All semiconductor products (also referred to herein as "components") are sold subject to TI's terms and conditions of sale supplied at the time of order acknowledgment.

TI warrants performance of its components to the specifications applicable at the time of sale, in accordance with the warranty in TI's terms and conditions of sale of semiconductor products. Testing and other quality control techniques are used to the extent TI deems necessary to support this warranty. Except where mandated by applicable law, testing of all parameters of each component is not necessarily performed.

TI assumes no liability for applications assistance or the design of Buyers' products. Buyers are responsible for their products and applications using TI components. To minimize the risks associated with Buyers' products and applications, Buyers should provide adequate design and operating safeguards.

TI does not warrant or represent that any license, either express or implied, is granted under any patent right, copyright, mask work right, or other intellectual property right relating to any combination, machine, or process in which TI components or services are used. Information published by TI regarding third-party products or services does not constitute a license to use such products or services or a warranty or endorsement thereof. Use of such information may require a license from a third party under the patents or other intellectual property of the third party, or a license from TI under the patents or other intellectual property of TI.

Reproduction of significant portions of TI information in TI data books or data sheets is permissible only if reproduction is without alteration and is accompanied by all associated warranties, conditions, limitations, and notices. TI is not responsible or liable for such altered documentation. Information of third parties may be subject to additional restrictions.

Resale of TI components or services with statements different from or beyond the parameters stated by TI for that component or service voids all express and any implied warranties for the associated TI component or service and is an unfair and deceptive business practice. TI is not responsible or liable for any such statements.

Buyer acknowledges and agrees that it is solely responsible for compliance with all legal, regulatory and safety-related requirements concerning its products, and any use of TI components in its applications, notwithstanding any applications-related information or support that may be provided by TI. Buyer represents and agrees that it has all the necessary expertise to create and implement safeguards which anticipate dangerous consequences of failures, monitor failures and their consequences, lessen the likelihood of failures that might cause harm and take appropriate remedial actions. Buyer will fully indemnify TI and its representatives against any damages arising out of the use of any TI components in safety-critical applications.

In some cases, TI components may be promoted specifically to facilitate safety-related applications. With such components, TI's goal is to help enable customers to design and create their own end-product solutions that meet applicable functional safety standards and requirements. Nonetheless, such components are subject to these terms.

No TI components are authorized for use in FDA Class III (or similar life-critical medical equipment) unless authorized officers of the parties have executed a special agreement specifically governing such use.

Only those TI components which TI has specifically designated as military grade or "enhanced plastic" are designed and intended for use in military/aerospace applications or environments. Buyer acknowledges and agrees that any military or aerospace use of TI components which have **not** been so designated is solely at the Buyer's risk, and that Buyer is solely responsible for compliance with all legal and regulatory requirements in connection with such use.

TI has specifically designated certain components which meet ISO/TS16949 requirements, mainly for automotive use. Components which have not been so designated are neither designed nor intended for automotive use; and TI will not be responsible for any failure of such components to meet such requirements.

Products

Audio	www.ti.com/audio
Amplifiers	amplifier.ti.com
Data Converters	dataconverter.ti.com
DLP® Products	www.dlp.com
DSP	dsp.ti.com
Clocks and Timers	www.ti.com/clocks
Interface	interface.ti.com
Logic	logic.ti.com
Power Mgmt	power.ti.com
Microcontrollers	microcontroller.ti.com
RFID	www.ti-rfid.com
OMAP Applications Processors	www.ti.com/omap
Wireless Connectivity	www.ti.com/wirelessconnectivity

Applications

Automotive and Transportation	www.ti.com/automotive
Communications and Telecom	www.ti.com/communications
Computers and Peripherals	www.ti.com/computers
Consumer Electronics	www.ti.com/consumer-apps
Energy and Lighting	www.ti.com/energy
Industrial	www.ti.com/industrial
Medical	www.ti.com/medical
Security	www.ti.com/security
Space, Avionics and Defense	www.ti.com/space-avionics-defense
Video and Imaging	www.ti.com/video

TI E2E Community

e2e.ti.com