

## CMOS Low-Power Monostable/Astable Multivibrator

High Voltage Types (20-Volt Rating)

■ CD4047B consists of a gatatable astable multivibrator with logic techniques incorporated to permit positive or negative edge-triggered monostable multivibrator action with retriggering and external counting options.

Inputs include +TRIGGER, -TRIGGER, ASTABLE, ASTABLE, RETRIGGER, and EXTERNAL RESET. Buffered outputs are Q, Q, and OSCILLATOR. In all modes of operation, and external capacitor must be connected between C-Timing and RC-Common terminals, and an external resistor must be connected between the R-Timing and RC-Common terminals.

Astable operation is enabled by a high level on the ASTABLE input or a low level on the ASTABLE input, or both. The period of the square wave at the Q and Q Outputs in this mode of operation is a function of the external components employed. "True" input pulses on the ASTABLE input or "Complement" pulses on the ASTABLE input allow the circuit to be used as a gatatable multivibrator. The OSCILLATOR output period will be half of the Q terminal output in the astable mode. However, a 50% duty cycle is not guaranteed at this output.

The CD4047B triggers in the monostable mode when a positive-going edge occurs on the + TRIGGER-input while the -TRIGGER is held low. Input pulses may be of any duration relative to the output pulse.

If retrigger capability is desired, the RETRIGGER input is pulsed. The retriggerable mode of operation is limited to positive-going edge. The CD4047B will retrigger as long as the RETRIGGER-input is high, with or without transitions (See Fig. 34).

An external countdown option can be implemented by coupling "Q" to an external "N" counter and resetting the counter with the trigger pulse. The counter output pulse is fed back to the ASTABLE input and has a duration equal to N times the period of the multivibrator.

A high level on the EXTERNAL RESET input assures no output pulse during an "ON" power condition. This input can also be activated to terminate the output pulse at any time. For monostable operation, whenever V<sub>DD</sub> is applied, an internal power-on reset circuit will clock the Q output low within one output period (t<sub>M</sub>).

The CD4047B-Series types are supplied in 14-lead hermetic dual-in-line ceramic packages (F3A suffix), 14-lead dual-in-line plastic packages (E suffix), 14-lead small-outline packages (M, MT, M96, and NSR suffixes), and 14-lead thin shrink small-outline packages (PW and PWR suffixes).

### Features:

- Low power consumption: special CMOS oscillator configuration
- Monostable (one-shot) or astable (free-running) operation
- True and complemented buffered outputs
- Only one external R and C required
- Buffered inputs
- 100% tested for quiescent current at 20 V
- Standardized, symmetrical output characteristics
- 5-V, 10-V, and 15-V parametric ratings
- Meets all requirements of JEDEC Tentative Standard No. 13B, "Standard Specifications for Description of 'B' Series CMOS Devices"

### Monostable Multivibrator Features:

- Positive- or negative-edge trigger
- Output pulse width independent of trigger pulse duration
- Retriggerable option for pulse width expansion
- Internal power-on reset circuit
- Long pulse widths possible using small RC components by means of external counter provision
- Fast recovery time essentially independent of pulse width
- Pulse-width accuracy maintained at duty cycles approaching 100%

### Astable Multivibrator Features:

- Free-running or gatatable operating modes
- 50% duty cycle

- Oscillator output available
- Good astable frequency stability:  
Frequency deviation:  
= ± 2% + 0.03%/°C @ 100 kHz  
= ± 0.5% + 0.015%/°C @ 10 kHz  
(circuits "trimmed" to frequency V<sub>DD</sub> = 10 V ± 10%)

### Applications:

Digital equipment where low-power dissipation and/or high noise immunity are primary design requirements:

- Envelope detection
- Frequency multiplication
- Frequency division
- Frequency discriminators
- Timing circuits
- Time-delay applications

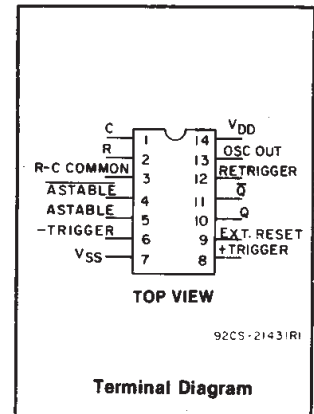

### RECOMMENDED OPERATING CONDITIONS

For maximum reliability, nominal operating conditions should be selected so that operation is always within the following ranges:

| CHARACTERISTIC   | LIMITS |      | UNITS |
|--|--------|------|-------|
|  | MIN.   | MAX. |       |
| Supply-Voltage Range (For T <sub>A</sub> = Full Package-Temperature Range) | 3      | 18   | V     |

NOTE: IF AT 15 V OPERATION A 10 MΩ RESISTOR IS USED THE OPERATING TEMPERATURE SHOULD BE BETWEEN -25°C and 100°C

### MAXIMUM RATINGS, Absolute-Maximum Values:

|   |                                     |
|---|-------------------------------------|
| DC SUPPLY-VOLTAGE RANGE, (V <sub>DD</sub> )<br>Voltages referenced to V <sub>SS</sub> Terminal                      | -0.5V to +20V                       |
| INPUT VOLTAGE RANGE, ALL INPUTS   | -0.5V to V <sub>DD</sub> + 0.5V     |
| DC INPUT CURRENT, ANY ONE INPUT   | ±10mA                               |
| POWER DISSIPATION PER PACKAGE (P <sub>D</sub> ):<br>For T <sub>A</sub> = -55°C to +100°C                            | 500mW                               |
| For T <sub>A</sub> = +100°C to +125°C   | Derate Linearly at 12mW/°C to 200mW |
| DEVICE DISSIPATION PER OUTPUT TRANSISTOR<br>FOR T <sub>A</sub> = FULL PACKAGE-TEMPERATURE RANGE (All Package Types) | 100mW                               |
| OPERATING-TEMPERATURE RANGE (T <sub>A</sub> )   | -55°C to +125°C                     |
| STORAGE TEMPERATURE RANGE (T <sub>stg</sub> )   | -65°C to +150°C                     |
| LEAD TEMPERATURE (DURING SOLDERING):<br>At distance 1/16 ± 1/32 inch (1.59 ± 0.79mm) from case for 10s max          | +265°C                              |

# CD4047B Types

## CD4047B FUNCTIONAL TERMINAL CONNECTIONS

NOTE: IN ALL CASES EXTERNAL RESISTOR BETWEEN TERMINALS 2 AND 3▲  
EXTERNAL CAPACITOR BETWEEN TERMINALS 1 AND 3▲

| FUNCTION   | TERMINAL CONNECTIONS |                    |          | OUTPUT PULSE FROM | OUTPUT PERIOD OR PULSE WIDTH |
|--|----------------------|--------------------|----------|-------------------|------------------------------|
|  | TO V <sub>DD</sub>   | TO V <sub>SS</sub> | INPUT TO |                   |                              |
| Astable Multivibrator:<br>Free Running             | 4,5,6,14             | 7,8,9,12           | —        | 10,11,13          | $t_A(10,11) = 4.40 RC$       |
| True Gating  | 4,6,14               | 7,8,9,12           | 5        | 10,11,13          | $t_A(13) = 2.20 RC^*$        |
| Complement Gating                                  | 6,14                 | 5,7,8,9,12         | 4        | 10,11,13          |                              |
| Monostable Multivibrator:<br>Positive-Edge Trigger | 4,14                 | 5,6,7,9,12         | 8        | 10,11             | $t_M(10,11) = 2.48 RC$       |
| Negative-Edge Trigger                              | 4,8,14               | 5,7,9,12           | 6        | 10,11             |                              |
| Retriggerable                                      | 4,14                 | 5,6,7,9            | 8,12     | 10,11             |                              |
| External Countdown*                                | 14                   | 5,6,7,8,9,12       | —        | 10,11             |                              |

▲ See Text.

\* First positive 1/2 cycle pulse-width = 2.48 RC, see Note on Page 3-134.

\* Input Pulse to Reset of External Counting Chip External Counting Chip Output To Terminal 4

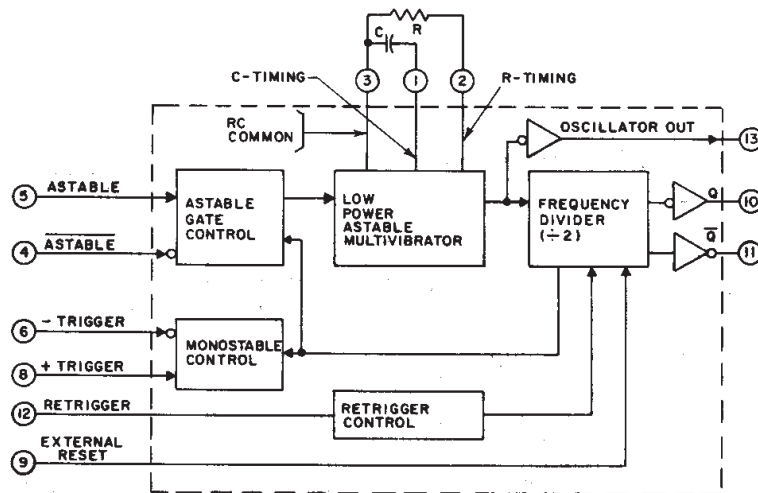

Fig. 1—CD4047B logic block diagram.

92CS-29071

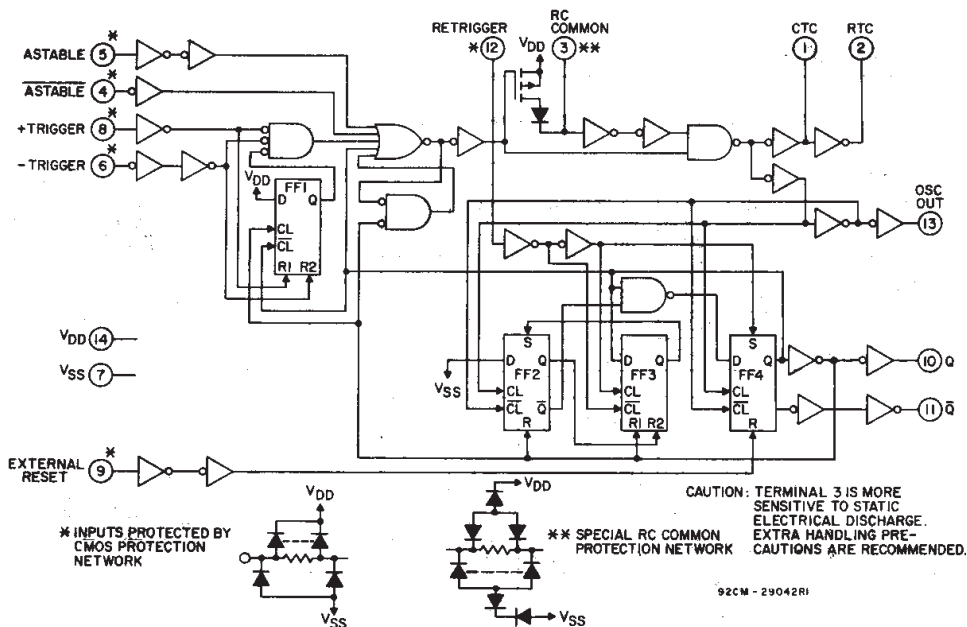

Fig. 2—CD4047B logic diagram.

92CM-29042R1

# CD4047B Types

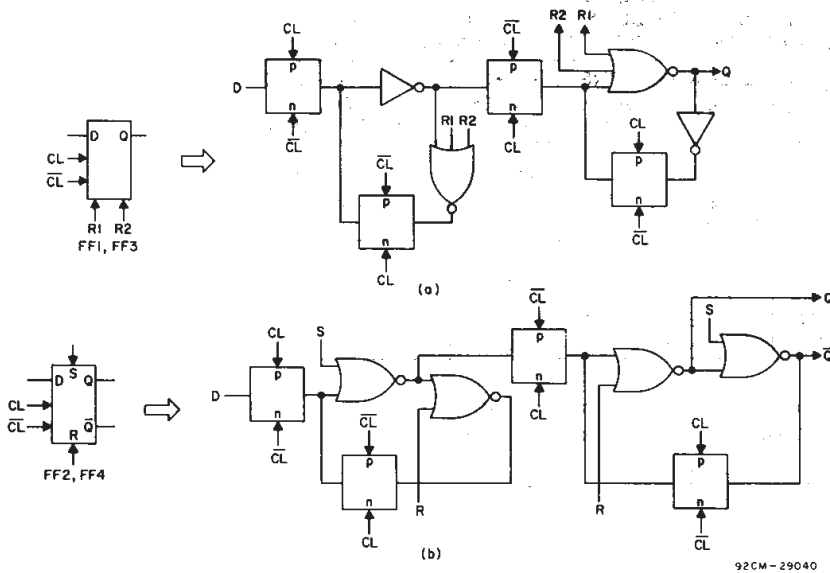

Fig. 3—Detail logic diagram for flip-flops FF1 and FF3 (a) and for flip-flops FF2 and FF4 (b).

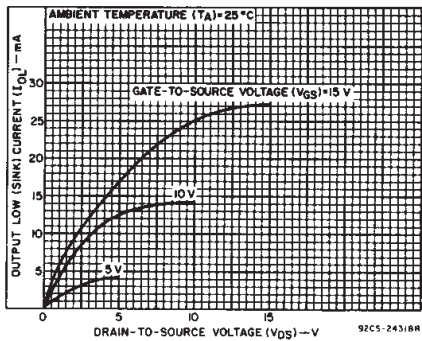

Fig. 4—Typical output low (sink) current characteristics.

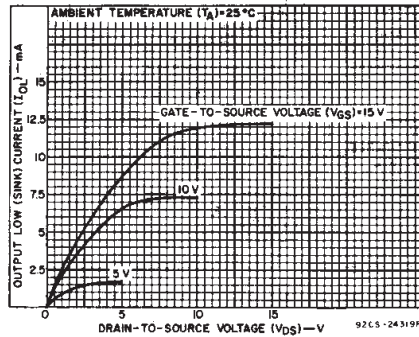

Fig. 5—Minimum output low (sink) current characteristics.

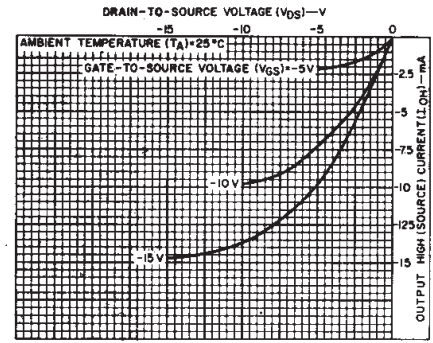

Fig. 6—Typical output high (source) current characteristics.

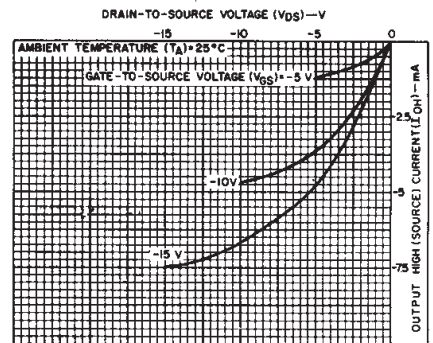

Fig. 7—Minimum output high (source) current characteristics.

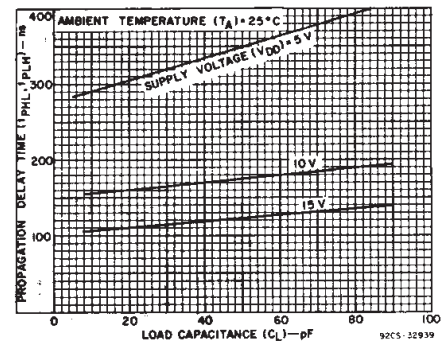

Fig. 8—Typical propagation delay time as a function of load capacitance (Astable, Astable to Q, Q̄).

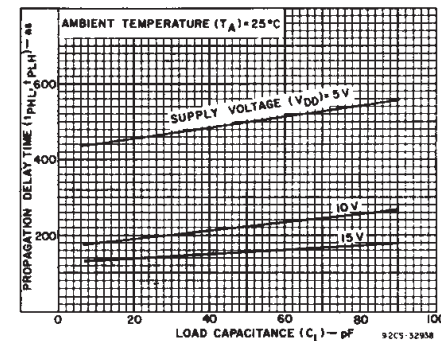

Fig. 9—Typical propagation delay time as a function of load capacitance (+ or - trigger to Q, Q̄).

## STATIC ELECTRICAL CHARACTERISTICS

| CHARACTERISTICS                                    | CONDITIONS         |                     |                     | LIMITS AT INDICATED TEMPERATURES (°C) |       |       |       |       |      |      | UNITS |
|--|--------------------|---------------------|---------------------|---------------------------------------|-------|-------|-------|-------|------|------|-------|
|  | V <sub>O</sub> (V) | V <sub>IN</sub> (V) | V <sub>DD</sub> (V) | -55                                   | -40   | +85   | +125  | +25   |      |      |       |
|  |                    |                     |                     |                                       |       |       |       | Min.  | Typ. | Max. |       |
| Quiescent Device Current, I <sub>DD</sub> Max.     | —                  | 0,5                 | 5                   | 1                                     | 1     | 30    | 30    | —     | 0,02 | 1    | μA    |
|  | —                  | 0,10                | 10                  | 2                                     | 2     | 60    | 60    | —     | 0,02 | 2    |       |
|  | —                  | 0,15                | 15                  | 4                                     | 4     | 120   | 120   | —     | 0,02 | 4    |       |
| Output Low (Sink) Current I <sub>OL</sub> Min.     | 0,4                | 0,5                 | 5                   | 0,64                                  | 0,61  | 0,42  | 0,36  | 0,51  | 1    | —    | mA    |
|  | 0,5                | 0,10                | 10                  | 1,6                                   | 1,5   | 1,1   | 0,9   | 1,3   | 2,6  | —    |       |
|  | 1,5                | 0,15                | 15                  | 4,2                                   | 4     | 2,8   | 2,4   | 3,4   | 6,8  | —    |       |
| Output High (Source) Current, I <sub>OH</sub> Min. | 4,6                | 0,5                 | 5                   | -0,64                                 | -0,61 | -0,42 | -0,36 | -0,51 | -1   | —    | mA    |
|  | 2,5                | 0,5                 | 5                   | -2                                    | -1,8  | -1,3  | -1,15 | -1,6  | -3,2 | —    |       |
|  | 9,5                | 0,10                | 10                  | -1,6                                  | -1,5  | -1,1  | -0,9  | -1,3  | -2,6 | —    |       |
| Output Voltage: Low-Level V <sub>OL</sub> Max.     | —                  | 0,5                 | 5                   | 0,05                                  |       |       | —     | 0     | 0,05 | —    | V     |
|  | —                  | 0,10                | 10                  | 0,05                                  |       |       | —     | 0     | 0,05 | —    |       |
|  | —                  | 0,15                | 15                  | 0,05                                  |       |       | —     | 0     | 0,05 | —    |       |

# CD4047B Types

## STATIC ELECTRICAL CHARACTERISTICS (CONTINUED)

| CHARACTERISTICS                                  | CONDITIONS         |                     |                     | LIMITS AT INDICATED TEMPERATURES (°C) |      |     |      |       |                  | UNITS |      |
|--|--------------------|---------------------|---------------------|---------------------------------------|------|-----|------|-------|------------------|-------|------|
|  | V <sub>O</sub> (V) | V <sub>IN</sub> (V) | V <sub>DD</sub> (V) | -55                                   | -40  | +85 | +125 | +25   |                  |       |      |
|  |                    |                     |                     |                                       |      |     |      | Min.  | Typ.             |       | Max. |
| Output Voltage: High-Level, V <sub>OH</sub> Min. | —                  | 0.5                 | 5                   | 4.95                                  |      |     |      | 4.95  | 5                | —     | V    |
|  | —                  | 0.10                | 10                  | 9.95                                  |      |     |      | 9.95  | 10               | —     |      |
|  | —                  | 0.15                | 15                  | 14.95                                 |      |     |      | 14.95 | 15               | —     |      |
| Input Low Voltage, V <sub>IL</sub> Max.          | 0.5, 4.5           | —                   | 5                   | 1.5                                   |      |     |      | —     | —                | 1.5   | V    |
|  | 1.9                | —                   | 10                  | 3                                     |      |     |      | —     | —                | 3     |      |
|  | 1.5, 13.5          | —                   | 15                  | 4                                     |      |     |      | —     | —                | 4     |      |
| Input High Voltage, V <sub>IH</sub> Min.         | 0.5, 4.5           | —                   | 5                   | 3.5                                   |      |     |      | 3.5   | —                | —     | V    |
|  | 1.9                | —                   | 10                  | 7                                     |      |     |      | 7     | —                | —     |      |
|  | 1.5, 13.5          | —                   | 15                  | 11                                    |      |     |      | 11    | —                | —     |      |
| Input Current I <sub>IN</sub> Max.               | —                  | 0.18                | 18                  | ±0.1                                  | ±0.1 | ±1  | ±1   | —     | ±10 <sup>5</sup> | ±0.1  | μA   |

**DYNAMIC ELECTRICAL CHARACTERISTICS** at T<sub>A</sub> = 25°C; Input t<sub>r</sub>, t<sub>f</sub> = 20 ns, C<sub>L</sub> = 50 pF, R<sub>L</sub> = 200 kΩ

| CHARACTERISTIC  | V <sub>DD</sub> (V) | LIMITS |      |      | UNITS |
|---|---------------------|--------|------|------|-------|
|   |                     | MIN.   | TYP. | MAX. |       |
| Propagation Delay Time, t <sub>PHL</sub> , t <sub>PLH</sub><br>Astable, Astable to Osc. Out   | 5                   | —      | 200  | 400  | ns    |
|   | 10                  | —      | 100  | 200  |       |
|   | 15                  | —      | 80   | 160  |       |
| Astable, Astable to Q, Q̄   | 5                   | —      | 350  | 700  |       |
|   | 10                  | —      | 175  | 350  |       |
|   | 15                  | —      | 125  | 250  |       |
| + or - Trigger to Q, Q̄   | 5                   | —      | 500  | 1000 |       |
|   | 10                  | —      | 225  | 450  |       |
|   | 15                  | —      | 150  | 300  |       |
| Retrigger to Q, Q̄  | 5                   | —      | 300  | 600  |       |
|   | 10                  | —      | 150  | 300  |       |
|   | 15                  | —      | 100  | 200  |       |
| External Reset to Q, Q̄   | 5                   | —      | 250  | 500  |       |
|   | 10                  | —      | 100  | 200  |       |
|   | 15                  | —      | 70   | 140  |       |
| Transition Time, t <sub>NL</sub> , t <sub>LH</sub><br>Osc. Out, Q, Q̄   | 5                   | —      | 100  | 200  |       |
|   | 10                  | —      | 50   | 100  |       |
|   | 15                  | —      | 40   | 80   |       |
| Minimum Input Pulse Width, t <sub>w</sub><br>+ Trigger, - Trigger   | 5                   | —      | 200  | 400  |       |
|   | 10                  | —      | 80   | 160  |       |
|   | 15                  | —      | 50   | 100  |       |
| Reset   | 5                   | —      | 100  | 200  |       |
|   | 10                  | —      | 50   | 100  |       |
|   | 15                  | —      | 30   | 60   |       |
| Retrigger   | 5                   | —      | 300  | 600  |       |
|   | 10                  | —      | 115  | 230  |       |
|   | 15                  | —      | 75   | 150  |       |
| Input Rise and Fall Time, t <sub>r</sub> , t <sub>f</sub><br>All Trigger Inputs<br>For + Trigger: t <sub>r</sub><br>t <sub>r</sub> only is unlimited<br>For - Trigger: t <sub>f</sub><br>t <sub>f</sub> only is unlimited | 5                   | —      | 270  | —    | μs    |
|   | 10                  | —      | 18   | —    |       |
|   | 15                  | —      | 9    | —    |       |
|   | 5                   | —      | 325  | —    |       |
|   | 10                  | —      | 9    | —    |       |
|   | 15                  | —      | 4    | —    |       |
| Q or Q̄ Deviation from 50% Duty Factor  | 5                   | —      | ±0.5 | ±1   | %     |
|   | 10                  | —      | ±0.5 | ±1   |       |
|   | 15                  | —      | ±0.1 | ±0.5 |       |
| Input Capacitance, C <sub>IN</sub>  | Any Input           | —      | 5    | 7.7  | pF    |

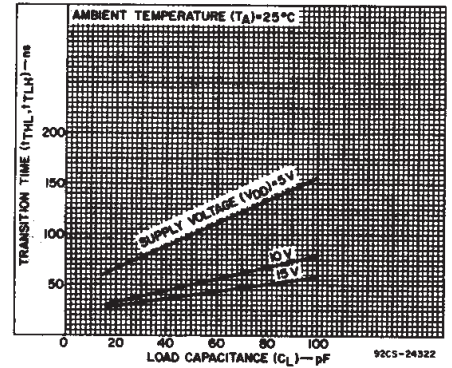

Fig. 10—Typical transition time as a function of load capacitance.

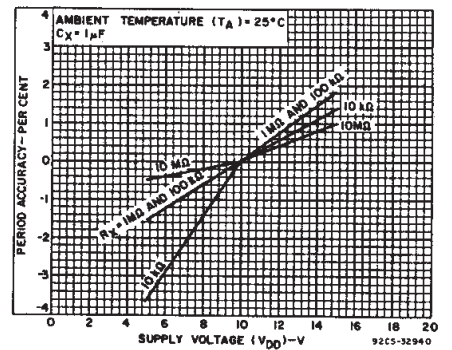

Fig. 11—Typical astable oscillator or Q, Q̄ period accuracy vs. supply voltage.

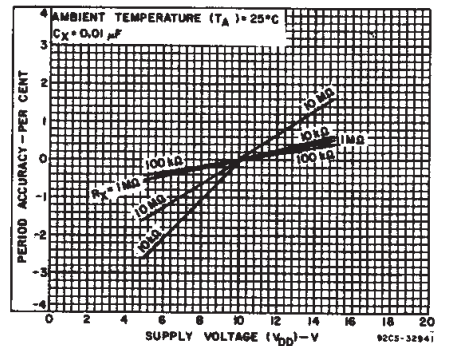

Fig. 12—Typical astable oscillator or Q, Q̄ period accuracy vs. supply voltage.

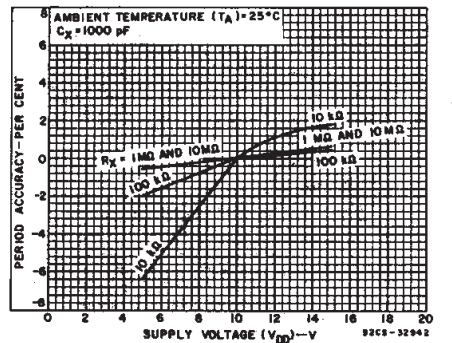

Fig. 13—Typical astable oscillator or Q, Q̄ period accuracy vs. supply voltage.



# CD4047B Types

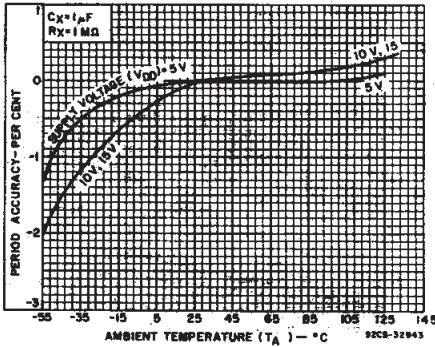

Fig. 14—Typical astable oscillator or  $Q, \bar{Q}$  period accuracy vs. ambient temperature (ultra-low frequency).

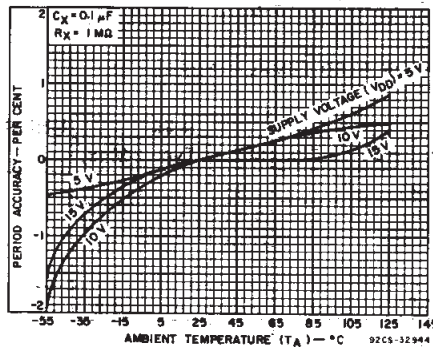

Fig. 15—Typical astable oscillator or  $Q, \bar{Q}$  period accuracy vs. ambient temperature (low frequency).

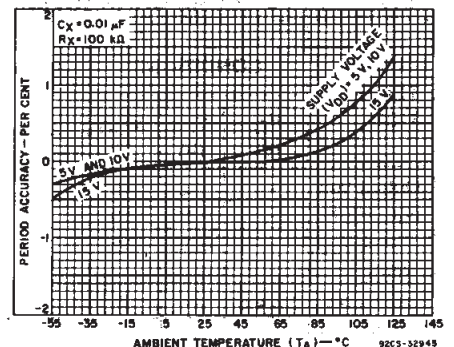

Fig. 16—Typical astable oscillator or  $Q, \bar{Q}$  period accuracy vs. ambient temperature (medium frequency).

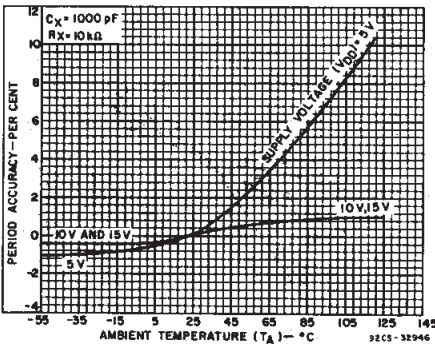

Fig. 17—Typical astable oscillator or  $Q, \bar{Q}$  period accuracy vs. ambient temperature (high-frequency).

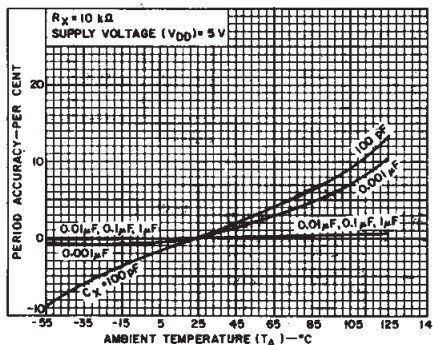

Fig. 18—Typical astable oscillator or  $Q, \bar{Q}$  period accuracy vs. ambient temperature.

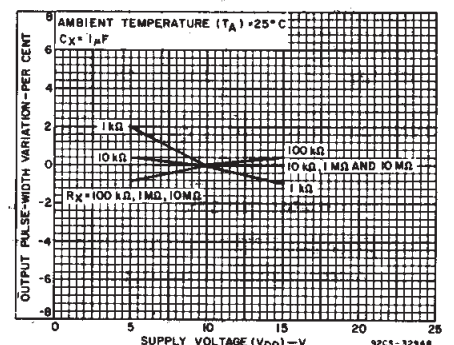

Fig. 19—Typical output pulse-width variations vs. supply voltage.

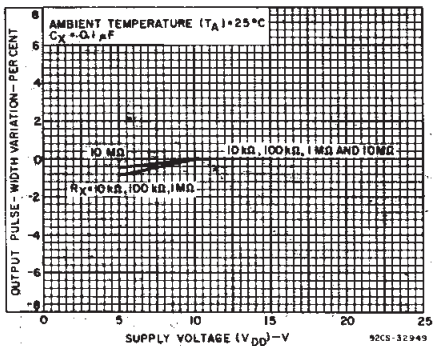

Fig. 20—Typical output pulse-width variations vs. supply voltage.

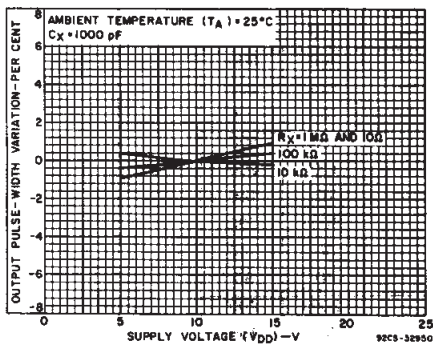

Fig. 21—Typical output pulse-width variations vs. supply voltage.

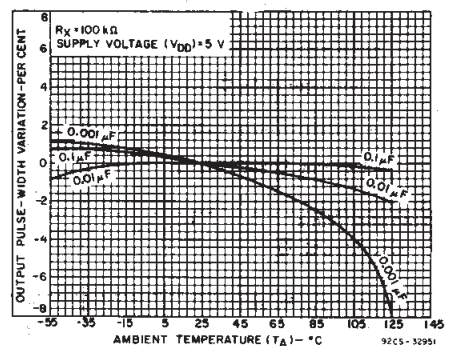

Fig. 22—Typical output pulse-width variations vs. ambient temperature.

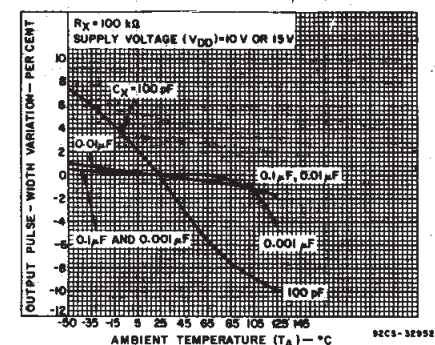

Fig. 23—Typical output pulse-width variations vs. ambient temperature.

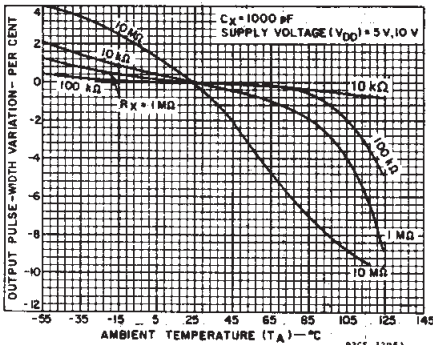

Fig. 24—Typical output pulse-width variations vs. ambient temperature.

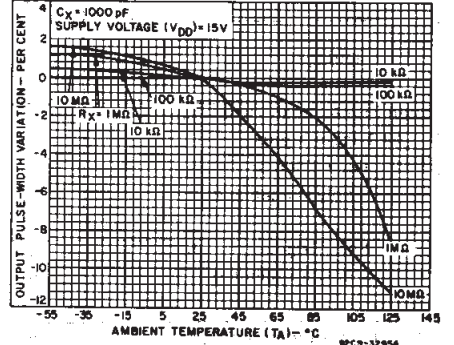

Fig. 25—Typical output pulse-width variations vs. ambient temperature.

# CD4047B Types

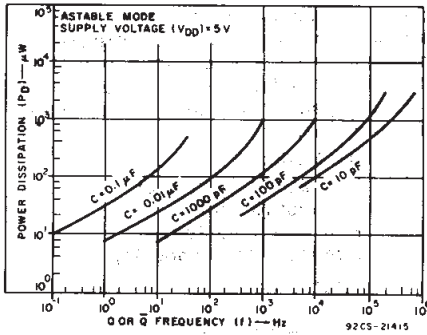

Fig. 26—Typical power dissipation vs. output frequency ( $V_{DD} = 5$  V).

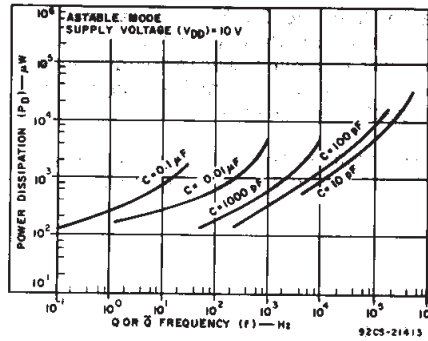

Fig. 27—Typical power dissipation vs. output frequency ( $V_{DD} = 10$  V).

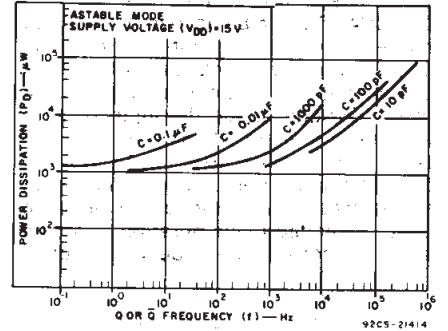

Fig. 28—Typical power dissipation vs. output frequency ( $V_{DD} = 15$  V).

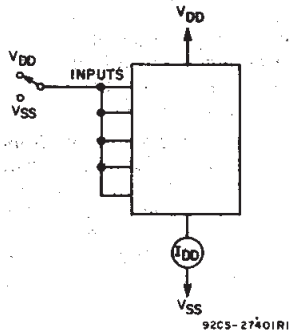

Fig. 29—Quiescent device current test circuit.

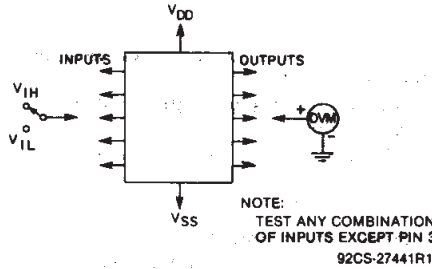

Fig. 30—Input-voltage test circuit.

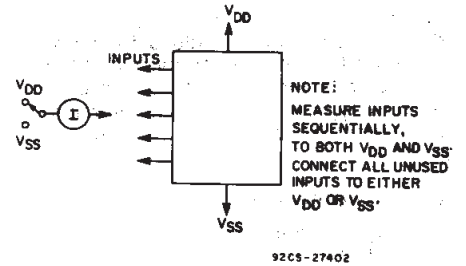

Fig. 31—Input-leakage-current test circuit.

## 1. Astable Mode Design Information

**A. Unit-to-Unit Transfer-Voltage Variations** — The following analysis presents variations from unit to unit as a function of transfer-voltage ( $V_{TR}$ ) shift (33%–67%  $V_{DD}$ ) for free-running (astable) operation.

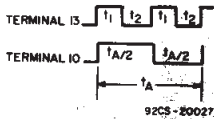

Fig. 32—Astable mode waveforms.

$$t_1 = -RC \ln \frac{V_{TR}}{V_{DD} + V_{TR}};$$

typically,  $t_1 = 1.1 RC$

$$t_2 = -RC \ln \frac{V_{DD} - V_{TR}}{2V_{DD} - V_{TR}};$$

typically,  $t_2 = 1.1 RC$

$$t_A = 2(t_1 + t_2)$$

$$= -2 RC \ln \frac{(V_{TR}V_{DD} - V_{TR})}{(V_{DD} + V_{TR})(2V_{DD} - V_{TR})}$$

Typ:  $V_{TR} = 0.5 V_{DD}$        $t_A = 4.40 RC$   
 Min:  $V_{TR} = 0.33 V_{DD}$      $t_A = 4.62 RC$   
 Max:  $V_{TR} = 0.67 V_{DD}$      $t_A = 4.62 RC$

thus if  $t_A = 4.40 RC$  is used, the variation will be +5%, -0% due to variations in transfer voltage.

**B. Variations Due to  $V_{DD}$  and Temperature Changes** — In addition to variations from unit to unit, the astable period varies with  $V_{DD}$  and temperature. Typical variations are presented in graphical form in Figs. 11 to 16 with 10V as reference for voltage variations curves and 25°C as reference for temperature variations curves.

## II. Monostable Mode Design Information

The following analysis presents variations from unit to unit as a function of transfer-voltage ( $V_{TR}$ ) shift (33% – 67%  $V_{DD}$ ) for one-shot (monostable) operation.

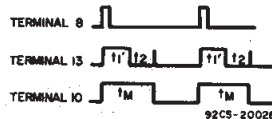

Fig. 33—Monostable waveforms.

$$t_1' = -RC \ln \frac{V_{TR}}{2V_{DD}}$$

typically,  $t_1' = 1.38 RC$

$$t_M = (t_1' + t_2)$$

$$t_M = -RC \ln \frac{(V_{TR})(V_{DD} - V_{TR})}{(2V_{DD} - V_{TR})(2V_{DD})}$$

where  $t_M$  = Monostable mode pulse width. Values for  $t_M$  are as follows:

Typ:  $V_{TR} = 0.5 V_{DD}$        $t_M = 2.48 RC$   
 Min:  $V_{TR} = 0.33 V_{DD}$      $t_M = 2.71 RC$   
 Max:  $V_{TR} = 0.67 V_{DD}$      $t_M = 2.48 RC$

thus if  $t_M = 2.48 RC$  is used, the variation will be +9.3%, -0% due to variations in transfer voltage.

### Note:

In the astable mode, the first positive half cycle has a duration of  $t_M$ ; succeeding durations are  $t_A/2$ .

In addition to variations from unit to unit, the monostable pulse width varies with  $V_{DD}$  and temperature. These variations are presented in graphical form in Fig. 19 to 26 with 10 V as reference for voltage-variation curves and 25°C as reference for temperature-variation curves.

## CD4047B Types

### III. Retrigger Mode Operation

The CD4047B can be used in the retrigger mode to extend the output-pulse duration, or to compare the frequency of an input signal with that of the internal oscillator. In the retrigger mode the input pulse is applied to terminal 12, and the output is taken from terminal 10 or 11. As shown in Fig. 34 normal monostable action is obtained when one retrigger pulse is applied. Extended pulse duration is obtained when more than one pulse is applied.

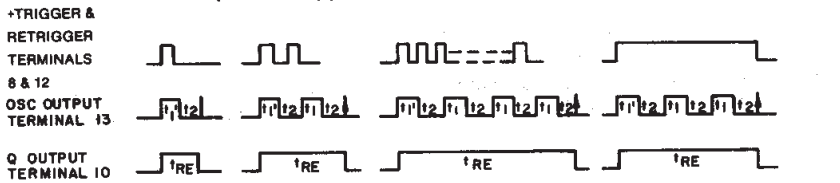

Fig. 34—Retrigger-mode waveforms.

For two input pulses,  $t_{RE} = t_1' + t_1 + 2t_2$ . For more than two pulses, the output pulse width is an integral number of time periods, with the first time period being  $t_1' + t_2$ , typically,  $2.48RC$ , and all subsequent time periods being  $t_1 + t_2$ , typically,  $2.2RC$ .

### IV. External Counter Option

Time  $t_M$  can be extended by any amount with the use of external counting cir-

cuitry. Advantages include digitally controlled pulse duration, small timing capacitors for long time periods, and extremely fast recovery time. A typical implementation is shown in Fig. 35. The pulse duration at the output is

$$t_{ext} = (N - 1)(t_A) + (t_M + t_A/2)$$

where  $t_{ext}$  = pulse duration of the circuitry, and  $N$  is the number of counts used.

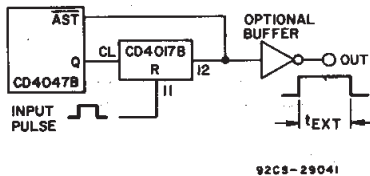

Fig. 35—Implementation of external counter option.

### V. Timing-Component Limitations

The capacitor used in the circuit should be non-polarized and have low leakage (i.e. the parallel resistance of the capacitor should be at least an order of magnitude greater than the external resistor used). There is no upper or lower limit for either  $R$  or  $C$  value to maintain oscillation.

However, in consideration of accuracy,  $C$  must be much larger than the inherent stray capacitance in the system (unless this capacitance can be measured and taken into account).  $R$  must be much

larger than the CMOS "ON" resistance in series with it, which typically is hundreds of ohms. In addition, with very large values of  $R$ , some short-term instability with respect to time may be noted.

The recommended values for these components to maintain agreement with

tion of leakage current in the circuit, as shown in the static electrical characteristics. For dynamic operation, the power needed to charge the external timing capacitor  $C$  is given by the following formulae:

Astable Mode:

$$P = 2CV^2f. \text{ (Output at terminal No. 13)}$$

$$P = 4CV^2f. \text{ (Output at terminal Nos. 10 and 11)}$$

Monostable Mode:

$$P = \frac{(2.9CV^2) (\text{Duty Cycle})}{T}$$

(Output at terminal Nos. 10 and 11)

The circuit is designed so that most of the total power is consumed in the external components. In practice, the lower the values of frequency and voltage used, the closer the actual power dissipation will be to the calculated value.

Because the power dissipation does not depend on  $R$ , a design for minimum power dissipation would be a small value of  $C$ . The value of  $R$  would depend on the desired period (within the limitations discussed above). See Figs. 27, 28, and 29 for typical power consumption in astable mode.

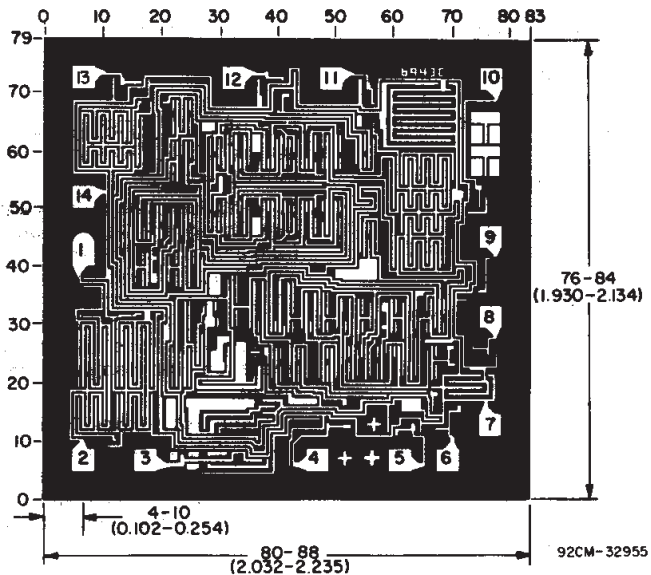

Chip dimensions and pad layout for CD4047B

Dimensions in parentheses are in millimeters and are derived from the basic inch dimensions as indicated. Grid graduations are in mils ( $10^{-3}$  inch).

**PACKAGING INFORMATION**

| Orderable Device | Status<br>(1) | Package Type | Package<br>Drawing | Pins | Package Qty | Eco Plan<br>(2)            | Lead/Ball Finish | MSL Peak Temp<br>(3) | Op Temp (°C) | Top-Side Markings<br>(4) | Samples                 |
|------------------|---------------|--------------|--------------------|------|-------------|----------------------------|------------------|----------------------|--------------|--------------------------|-------------------------|
| 8102001CA        | ACTIVE        | CDIP         | J                  | 14   | 1           | TBD                        | Call TI          | Call TI              | -55 to 125   | 8102001CA<br>CD4047BF3A  | <a href="#">Samples</a> |
| CD4047BD3        | ACTIVE        | CDIP SB      | JD                 | 14   | 1           | TBD                        | POST-PLATE       | N / A for Pkg Type   | -55 to 125   | CD4047BD/3               | <a href="#">Samples</a> |
| CD4047BE         | ACTIVE        | PDIP         | N                  | 14   | 25          | Pb-Free<br>(RoHS)          | CU NIPDAU        | N / A for Pkg Type   | -55 to 125   | CD4047BE                 | <a href="#">Samples</a> |
| CD4047BEE4       | ACTIVE        | PDIP         | N                  | 14   | 25          | Pb-Free<br>(RoHS)          | CU NIPDAU        | N / A for Pkg Type   | -55 to 125   | CD4047BE                 | <a href="#">Samples</a> |
| CD4047BF         | ACTIVE        | CDIP         | J                  | 14   | 1           | TBD                        | A42              | N / A for Pkg Type   | -55 to 125   | CD4047BF                 | <a href="#">Samples</a> |
| CD4047BF3A       | ACTIVE        | CDIP         | J                  | 14   | 1           | TBD                        | A42              | N / A for Pkg Type   | -55 to 125   | 8102001CA<br>CD4047BF3A  | <a href="#">Samples</a> |
| CD4047BM         | ACTIVE        | SOIC         | D                  | 14   | 50          | Green (RoHS<br>& no Sb/Br) | CU NIPDAU        | Level-1-260C-UNLIM   | -55 to 125   | CD4047BM                 | <a href="#">Samples</a> |
| CD4047BM96       | ACTIVE        | SOIC         | D                  | 14   | 2500        | Green (RoHS<br>& no Sb/Br) | CU NIPDAU        | Level-1-260C-UNLIM   | -55 to 125   | CD4047BM                 | <a href="#">Samples</a> |
| CD4047BM96E4     | ACTIVE        | SOIC         | D                  | 14   | 2500        | Green (RoHS<br>& no Sb/Br) | CU NIPDAU        | Level-1-260C-UNLIM   | -55 to 125   | CD4047BM                 | <a href="#">Samples</a> |
| CD4047BM96G4     | ACTIVE        | SOIC         | D                  | 14   | 2500        | Green (RoHS<br>& no Sb/Br) | CU NIPDAU        | Level-1-260C-UNLIM   | -55 to 125   | CD4047BM                 | <a href="#">Samples</a> |
| CD4047BME4       | ACTIVE        | SOIC         | D                  | 14   | 50          | Green (RoHS<br>& no Sb/Br) | CU NIPDAU        | Level-1-260C-UNLIM   | -55 to 125   | CD4047BM                 | <a href="#">Samples</a> |
| CD4047BMG4       | ACTIVE        | SOIC         | D                  | 14   | 50          | Green (RoHS<br>& no Sb/Br) | CU NIPDAU        | Level-1-260C-UNLIM   | -55 to 125   | CD4047BM                 | <a href="#">Samples</a> |
| CD4047BMT        | ACTIVE        | SOIC         | D                  | 14   | 250         | Green (RoHS<br>& no Sb/Br) | CU NIPDAU        | Level-1-260C-UNLIM   | -55 to 125   | CD4047BM                 | <a href="#">Samples</a> |
| CD4047BMTE4      | ACTIVE        | SOIC         | D                  | 14   | 250         | Green (RoHS<br>& no Sb/Br) | CU NIPDAU        | Level-1-260C-UNLIM   | -55 to 125   | CD4047BM                 | <a href="#">Samples</a> |
| CD4047BMTG4      | ACTIVE        | SOIC         | D                  | 14   | 250         | Green (RoHS<br>& no Sb/Br) | CU NIPDAU        | Level-1-260C-UNLIM   | -55 to 125   | CD4047BM                 | <a href="#">Samples</a> |
| CD4047BNSR       | ACTIVE        | SO           | NS                 | 14   | 2000        | Green (RoHS<br>& no Sb/Br) | CU NIPDAU        | Level-1-260C-UNLIM   | -55 to 125   | CD4047B                  | <a href="#">Samples</a> |
| CD4047BNSRE4     | ACTIVE        | SO           | NS                 | 14   | 2000        | Green (RoHS<br>& no Sb/Br) | CU NIPDAU        | Level-1-260C-UNLIM   | -55 to 125   | CD4047B                  | <a href="#">Samples</a> |



| Orderable Device | Status<br>(1) | Package Type | Package Drawing | Pins | Package Qty | Eco Plan<br>(2)         | Lead/Ball Finish | MSL Peak Temp<br>(3) | Op Temp (°C) | Top-Side Markings<br>(4) | Samples                 |
|------------------|---------------|--------------|-----------------|------|-------------|-------------------------|------------------|----------------------|--------------|--------------------------|-------------------------|
| CD4047BNSRG4     | ACTIVE        | SO           | NS              | 14   | 2000        | Green (RoHS & no Sb/Br) | CU NIPDAU        | Level-1-260C-UNLIM   | -55 to 125   | CD4047B                  | <a href="#">Samples</a> |
| CD4047BPW        | ACTIVE        | TSSOP        | PW              | 14   | 90          | Green (RoHS & no Sb/Br) | CU NIPDAU        | Level-1-260C-UNLIM   | -55 to 125   | CM047B                   | <a href="#">Samples</a> |
| CD4047BPWE4      | ACTIVE        | TSSOP        | PW              | 14   | 90          | Green (RoHS & no Sb/Br) | CU NIPDAU        | Level-1-260C-UNLIM   | -55 to 125   | CM047B                   | <a href="#">Samples</a> |
| CD4047BPWG4      | ACTIVE        | TSSOP        | PW              | 14   | 90          | Green (RoHS & no Sb/Br) | CU NIPDAU        | Level-1-260C-UNLIM   | -55 to 125   | CM047B                   | <a href="#">Samples</a> |
| CD4047BPWR       | ACTIVE        | TSSOP        | PW              | 14   | 2000        | Green (RoHS & no Sb/Br) | CU NIPDAU        | Level-1-260C-UNLIM   | -55 to 125   | CM047B                   | <a href="#">Samples</a> |
| CD4047BPWRE4     | ACTIVE        | TSSOP        | PW              | 14   | 2000        | Green (RoHS & no Sb/Br) | CU NIPDAU        | Level-1-260C-UNLIM   | -55 to 125   | CM047B                   | <a href="#">Samples</a> |
| CD4047BPWRG4     | ACTIVE        | TSSOP        | PW              | 14   | 2000        | Green (RoHS & no Sb/Br) | CU NIPDAU        | Level-1-260C-UNLIM   | -55 to 125   | CM047B                   | <a href="#">Samples</a> |

(1) The marketing status values are defined as follows:

**ACTIVE:** Product device recommended for new designs.

**LIFEBUY:** TI has announced that the device will be discontinued, and a lifetime-buy period is in effect.

**NRND:** Not recommended for new designs. Device is in production to support existing customers, but TI does not recommend using this part in a new design.

**PREVIEW:** Device has been announced but is not in production. Samples may or may not be available.

**OBSOLETE:** TI has discontinued the production of the device.

(2) Eco Plan - The planned eco-friendly classification: Pb-Free (RoHS), Pb-Free (RoHS Exempt), or Green (RoHS & no Sb/Br) - please check <http://www.ti.com/productcontent> for the latest availability information and additional product content details.

**TBD:** The Pb-Free/Green conversion plan has not been defined.

**Pb-Free (RoHS):** TI's terms "Lead-Free" or "Pb-Free" mean semiconductor products that are compatible with the current RoHS requirements for all 6 substances, including the requirement that lead not exceed 0.1% by weight in homogeneous materials. Where designed to be soldered at high temperatures, TI Pb-Free products are suitable for use in specified lead-free processes.

**Pb-Free (RoHS Exempt):** This component has a RoHS exemption for either 1) lead-based flip-chip solder bumps used between the die and package, or 2) lead-based die adhesive used between the die and leadframe. The component is otherwise considered Pb-Free (RoHS compatible) as defined above.

**Green (RoHS & no Sb/Br):** TI defines "Green" to mean Pb-Free (RoHS compatible), and free of Bromine (Br) and Antimony (Sb) based flame retardants (Br or Sb do not exceed 0.1% by weight in homogeneous material)

(3) MSL, Peak Temp. -- The Moisture Sensitivity Level rating according to the JEDEC industry standard classifications, and peak solder temperature.

(4) Only one of markings shown within the brackets will appear on the physical device.

**Important Information and Disclaimer:** The information provided on this page represents TI's knowledge and belief as of the date that it is provided. TI bases its knowledge and belief on information provided by third parties, and makes no representation or warranty as to the accuracy of such information. Efforts are underway to better integrate information from third parties. TI has taken and

continues to take reasonable steps to provide representative and accurate information but may not have conducted destructive testing or chemical analysis on incoming materials and chemicals. TI and TI suppliers consider certain information to be proprietary, and thus CAS numbers and other limited information may not be available for release.

In no event shall TI's liability arising out of such information exceed the total purchase price of the TI part(s) at issue in this document sold by TI to Customer on an annual basis.

**OTHER QUALIFIED VERSIONS OF CD4047B, CD4047B-MIL :**

- Catalog: [CD4047B](#)
- Military: [CD4047B-MIL](#)

NOTE: Qualified Version Definitions:

- Catalog - TI's standard catalog product
- Military - QML certified for Military and Defense Applications

## TAPE AND REEL INFORMATION



### QUADRANT ASSIGNMENTS FOR PIN 1 ORIENTATION IN TAPE



\*All dimensions are nominal

| Device     | Package Type | Package Drawing | Pins | SPQ  | Reel Diameter (mm) | Reel Width W1 (mm) | A0 (mm) | B0 (mm) | K0 (mm) | P1 (mm) | W (mm) | Pin1 Quadrant |
|------------|--------------|-----------------|------|------|--------------------|--------------------|---------|---------|---------|---------|--------|---------------|
| CD4047BM96 | SOIC         | D               | 14   | 2500 | 330.0              | 16.4               | 6.5     | 9.0     | 2.1     | 8.0     | 16.0   | Q1            |
| CD4047BMT  | SOIC         | D               | 14   | 250  | 330.0              | 16.4               | 6.5     | 9.0     | 2.1     | 8.0     | 16.0   | Q1            |
| CD4047BPWR | TSSOP        | PW              | 14   | 2000 | 330.0              | 12.4               | 6.9     | 5.6     | 1.6     | 8.0     | 12.0   | Q1            |

**TAPE AND REEL BOX DIMENSIONS**



\*All dimensions are nominal

| Device     | Package Type | Package Drawing | Pins | SPQ  | Length (mm) | Width (mm) | Height (mm) |
|------------|--------------|-----------------|------|------|-------------|------------|-------------|
| CD4047BM96 | SOIC         | D               | 14   | 2500 | 367.0       | 367.0      | 38.0        |
| CD4047BMT  | SOIC         | D               | 14   | 250  | 367.0       | 367.0      | 38.0        |
| CD4047BPWR | TSSOP        | PW              | 14   | 2000 | 367.0       | 367.0      | 35.0        |

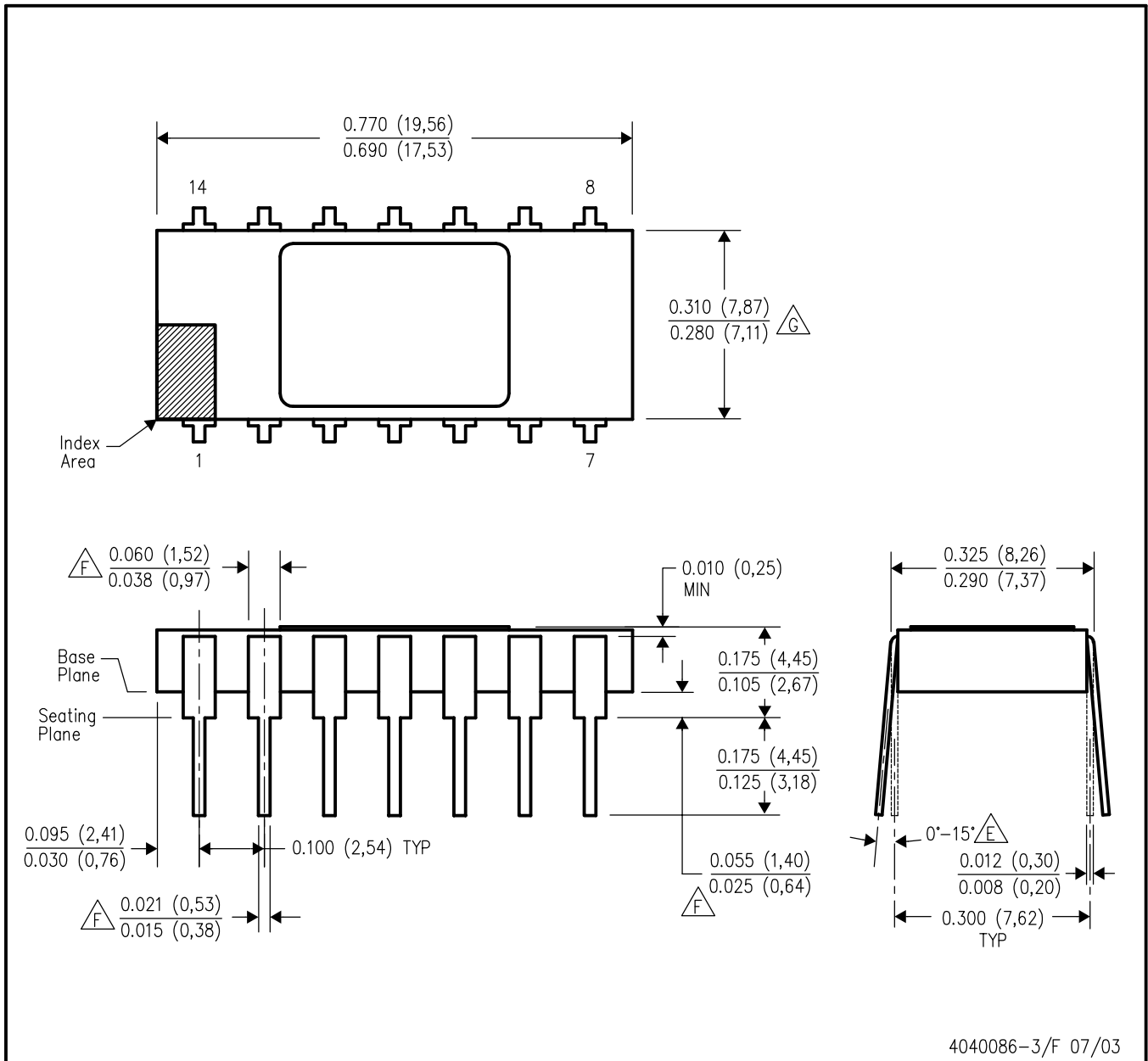

JD (R-CDIP-T14)

CERAMIC SIDE-BRAZE DUAL-IN-LINE



- NOTES:
- A. All linear dimensions are in inches (millimeters).
  - B. This drawing is subject to change without notice.
  - C. Controlling dimension: inch.
  - D. Leads within 0.005 (0,13) radius of true position (TP) at gage plane with maximum material condition and unit installed.
  - E. Angle applies to spread leads prior to installation.
  - F. Outlines on which the seating plane is coincident with the plane (standoff = 0), terminals lead standoffs are not required, and lead shoulder may equal lead width along any part of the lead above the seating/base plane.
  - G. Body width does not include particles of packing materials.
  - H. A visual index feature must be located within the cross-hatched area.

J (R-GDIP-T\*\*)

14 LEADS SHOWN

CERAMIC DUAL IN-LINE PACKAGE



| DIM \ PINS ** | 14                     | 16                     | 18                     | 20                     |
|---------------|------------------------|------------------------|------------------------|------------------------|
| A             | 0.300<br>(7,62)<br>BSC | 0.300<br>(7,62)<br>BSC | 0.300<br>(7,62)<br>BSC | 0.300<br>(7,62)<br>BSC |
| B MAX         | 0.785<br>(19,94)       | .840<br>(21,34)        | 0.960<br>(24,38)       | 1.060<br>(26,92)       |
| B MIN         | —                      | —                      | —                      | —                      |
| C MAX         | 0.300<br>(7,62)        | 0.300<br>(7,62)        | 0.310<br>(7,87)        | 0.300<br>(7,62)        |
| C MIN         | 0.245<br>(6,22)        | 0.245<br>(6,22)        | 0.220<br>(5,59)        | 0.245<br>(6,22)        |



4040083/F 03/03

- NOTES:
- All linear dimensions are in inches (millimeters).
  - This drawing is subject to change without notice.
  - This package is hermetically sealed with a ceramic lid using glass frit.
  - Index point is provided on cap for terminal identification only on press ceramic glass frit seal only.
  - Falls within MIL STD 1835 GDIP1-T14, GDIP1-T16, GDIP1-T18 and GDIP1-T20.

N (R-PDIP-T\*\*)

PLASTIC DUAL-IN-LINE PACKAGE

16 PINS SHOWN



- NOTES:
- A. All linear dimensions are in inches (millimeters).
  - B. This drawing is subject to change without notice.
  - Falls within JEDEC MS-001, except 18 and 20 pin minimum body length (Dim A).
  - The 20 pin end lead shoulder width is a vendor option, either half or full width.

D (R-PDSO-G14)

PLASTIC SMALL OUTLINE



- NOTES:
- A. All linear dimensions are in inches (millimeters).
  - B. This drawing is subject to change without notice.
  -  Body length does not include mold flash, protrusions, or gate burrs. Mold flash, protrusions, or gate burrs shall not exceed 0.006 (0,15) each side.
  -  Body width does not include interlead flash. Interlead flash shall not exceed 0.017 (0,43) each side.
  - E. Reference JEDEC MS-012 variation AB.



D (R-PDSO-G14)

PLASTIC SMALL OUTLINE



- NOTES:
- A. All linear dimensions are in millimeters.
  - B. This drawing is subject to change without notice.
  - C. Publication IPC-7351 is recommended for alternate designs.
  - D. Laser cutting apertures with trapezoidal walls and also rounding corners will offer better paste release. Customers should contact their board assembly site for stencil design recommendations. Refer to IPC-7525 for other stencil recommendations.
  - E. Customers should contact their board fabrication site for solder mask tolerances between and around signal pads.



PW (R-PDSO-G14)

PLASTIC SMALL OUTLINE



- NOTES:
- All linear dimensions are in millimeters.
  - This drawing is subject to change without notice.
  - Publication IPC-7351 is recommended for alternate designs.
  - Laser cutting apertures with trapezoidal walls and also rounding corners will offer better paste release. Customers should contact their board assembly site for stencil design recommendations. Refer to IPC-7525 for other stencil recommendations.
  - Customers should contact their board fabrication site for solder mask tolerances between and around signal pads.

# MECHANICAL DATA

NS (R-PDSO-G\*\*)

PLASTIC SMALL-OUTLINE PACKAGE

14-PINS SHOWN



- NOTES:
- A. All linear dimensions are in millimeters.
  - B. This drawing is subject to change without notice.
  - C. Body dimensions do not include mold flash or protrusion, not to exceed 0,15.



## IMPORTANT NOTICE

Texas Instruments Incorporated and its subsidiaries (TI) reserve the right to make corrections, enhancements, improvements and other changes to its semiconductor products and services per JESD46, latest issue, and to discontinue any product or service per JESD48, latest issue. Buyers should obtain the latest relevant information before placing orders and should verify that such information is current and complete. All semiconductor products (also referred to herein as "components") are sold subject to TI's terms and conditions of sale supplied at the time of order acknowledgment.

TI warrants performance of its components to the specifications applicable at the time of sale, in accordance with the warranty in TI's terms and conditions of sale of semiconductor products. Testing and other quality control techniques are used to the extent TI deems necessary to support this warranty. Except where mandated by applicable law, testing of all parameters of each component is not necessarily performed.

TI assumes no liability for applications assistance or the design of Buyers' products. Buyers are responsible for their products and applications using TI components. To minimize the risks associated with Buyers' products and applications, Buyers should provide adequate design and operating safeguards.

TI does not warrant or represent that any license, either express or implied, is granted under any patent right, copyright, mask work right, or other intellectual property right relating to any combination, machine, or process in which TI components or services are used. Information published by TI regarding third-party products or services does not constitute a license to use such products or services or a warranty or endorsement thereof. Use of such information may require a license from a third party under the patents or other intellectual property of the third party, or a license from TI under the patents or other intellectual property of TI.

Reproduction of significant portions of TI information in TI data books or data sheets is permissible only if reproduction is without alteration and is accompanied by all associated warranties, conditions, limitations, and notices. TI is not responsible or liable for such altered documentation. Information of third parties may be subject to additional restrictions.

Resale of TI components or services with statements different from or beyond the parameters stated by TI for that component or service voids all express and any implied warranties for the associated TI component or service and is an unfair and deceptive business practice. TI is not responsible or liable for any such statements.

Buyer acknowledges and agrees that it is solely responsible for compliance with all legal, regulatory and safety-related requirements concerning its products, and any use of TI components in its applications, notwithstanding any applications-related information or support that may be provided by TI. Buyer represents and agrees that it has all the necessary expertise to create and implement safeguards which anticipate dangerous consequences of failures, monitor failures and their consequences, lessen the likelihood of failures that might cause harm and take appropriate remedial actions. Buyer will fully indemnify TI and its representatives against any damages arising out of the use of any TI components in safety-critical applications.

In some cases, TI components may be promoted specifically to facilitate safety-related applications. With such components, TI's goal is to help enable customers to design and create their own end-product solutions that meet applicable functional safety standards and requirements. Nonetheless, such components are subject to these terms.

No TI components are authorized for use in FDA Class III (or similar life-critical medical equipment) unless authorized officers of the parties have executed a special agreement specifically governing such use.

Only those TI components which TI has specifically designated as military grade or "enhanced plastic" are designed and intended for use in military/aerospace applications or environments. Buyer acknowledges and agrees that any military or aerospace use of TI components which have **not** been so designated is solely at the Buyer's risk, and that Buyer is solely responsible for compliance with all legal and regulatory requirements in connection with such use.

TI has specifically designated certain components as meeting ISO/TS16949 requirements, mainly for automotive use. In any case of use of non-designated products, TI will not be responsible for any failure to meet ISO/TS16949.

### Products

|                              |  |
|------------------------------|--|
| Audio                        | <a href="http://www.ti.com/audio">www.ti.com/audio</a>                               |
| Amplifiers                   | <a href="http://amplifier.ti.com">amplifier.ti.com</a>                               |
| Data Converters              | <a href="http://dataconverter.ti.com">dataconverter.ti.com</a>                       |
| DLP® Products                | <a href="http://www.dlp.com">www.dlp.com</a>   |
| DSP                          | <a href="http://dsp.ti.com">dsp.ti.com</a>   |
| Clocks and Timers            | <a href="http://www.ti.com/clocks">www.ti.com/clocks</a>                             |
| Interface                    | <a href="http://interface.ti.com">interface.ti.com</a>                               |
| Logic                        | <a href="http://logic.ti.com">logic.ti.com</a>                                       |
| Power Mgmt                   | <a href="http://power.ti.com">power.ti.com</a>                                       |
| Microcontrollers             | <a href="http://microcontroller.ti.com">microcontroller.ti.com</a>                   |
| RFID                         | <a href="http://www.ti-rfid.com">www.ti-rfid.com</a>                                 |
| OMAP Applications Processors | <a href="http://www.ti.com/omap">www.ti.com/omap</a>                                 |
| Wireless Connectivity        | <a href="http://www.ti.com/wirelessconnectivity">www.ti.com/wirelessconnectivity</a> |

### Applications

|                               |  |
|-------------------------------|--|
| Automotive and Transportation | <a href="http://www.ti.com/automotive">www.ti.com/automotive</a>                         |
| Communications and Telecom    | <a href="http://www.ti.com/communications">www.ti.com/communications</a>                 |
| Computers and Peripherals     | <a href="http://www.ti.com/computers">www.ti.com/computers</a>                           |
| Consumer Electronics          | <a href="http://www.ti.com/consumer-apps">www.ti.com/consumer-apps</a>                   |
| Energy and Lighting           | <a href="http://www.ti.com/energy">www.ti.com/energy</a>                                 |
| Industrial                    | <a href="http://www.ti.com/industrial">www.ti.com/industrial</a>                         |
| Medical                       | <a href="http://www.ti.com/medical">www.ti.com/medical</a>                               |
| Security                      | <a href="http://www.ti.com/security">www.ti.com/security</a>                             |
| Space, Avionics and Defense   | <a href="http://www.ti.com/space-avionics-defense">www.ti.com/space-avionics-defense</a> |
| Video and Imaging             | <a href="http://www.ti.com/video">www.ti.com/video</a>                                   |

### TI E2E Community

[e2e.ti.com](http://e2e.ti.com)