

CMOS BCD Rate Multiplier

High-Voltage Types (20-Volt Rating)

■ CD4527B is a low-power 4-bit digital rate multiplier that provides an output-pulse rate which is the clock-input-pulse rate multiplied by 1/10 times the BCD input. For example, when the BCD input is 8, there will be 8 output pulses for every 10 input pulses. This device may be used to perform arithmetic operations (add, subtract, divide, raise to a power), solve algebraic and differential equations, generate natural logarithms and trigonometric functions, A/D and D/A conversion, and frequency division.

For fractional multipliers with more than one digit, CD4527B devices may be cascaded in two different modes: the Add mode and the Multiply mode. (See Figs.12 and 15). In the Add mode,

$$\text{Output Rate} = (\text{Clock Rate}) \left[\begin{matrix} 0.1 \text{ BCD}_1 + 0.01 \text{ BCD}_2 + \\ 0.001 \text{ BCD}_3 + \dots \end{matrix} \right]$$

In the Multiply mode, the fraction programmed into the first rate multiplier is multiplied by the fraction programmed into the second one,

$$\text{e.g. } \frac{9}{10} \times \frac{4}{10} = \frac{36}{100} \text{ or 36 output}$$

pulses for every 100 clock input pulses.

The CD4527B types are supplied in 16-lead dual-in-line plastic packages (E suffix), 16-lead small-outline packages (NSR suffix), and 16-lead thin shrink small-outline packages (PW and PWR suffixes).

Applications:

- Numerical control
- Instrumentation
- Digital filtering
- Frequency synthesis

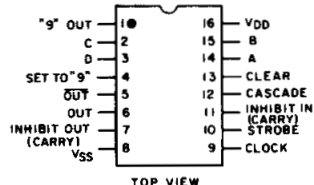

TERMINAL ASSIGNMENT

Features:

- Cascadable in multiples of 4-bits
- Set to "9" input and "9" detect output
- 100% test for quiescent current at 20 V
- 5-V, 10-V, and 15-V parametric ratings
- Standardized, symmetrical output characteristics
- Maximum input current of 1 μA at 18 V over full package-temperature range; 100 nA at 18 V and 25°C
- Noise margin (full package-temperature range) =
 - 1 V at V_{DD} = 5 V
 - 2 V at V_{DD} = 10 V
 - 2.5 V at V_{DD} = 15 V
- Meets all requirements of JEDEC Tentative Standard No. 13B, 'Standard Specifications for Description of 'B' Series CMOS Devices'

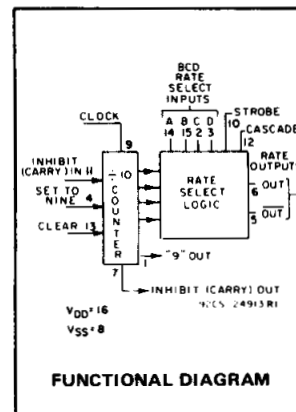

MAXIMUM RATINGS, Absolute-Maximum Values:

DC SUPPLY-VOLTAGE RANGE, (V_{DD})

Voltages referenced to V_{SS} Terminal) -0.5V to +20V

INPUT VOLTAGE RANGE, ALL INPUTS -0.5V to V_{DD} +0.5V

DC INPUT CURRENT, ANY ONE INPUT ±10mA

POWER DISSIPATION PER PACKAGE (P_D):

For T_A = -55°C to +100°C 500mW

For T_A = +100°C to +125°C Derate Linearity at 12mW/°C to 200mW

DEVICE DISSIPATION PER OUTPUT TRANSISTOR

FOR T_A = FULL PACKAGE-TEMPERATURE RANGE (All Package Types)..... 100mW

OPERATING-TEMPERATURE RANGE (T_A) -55°C to +125°C

STORAGE TEMPERATURE RANGE (T_{stg}) -65°C to +150°C

LEAD TEMPERATURE (DURING SOLDERING):

At distance 1/16 ± 1/32 inch (1.59 ± 0.79mm) from case for 10s max +265°C

RECOMMENDED OPERATING CONDITIONS AT T_A = 25°C, Except as Noted.

For maximum reliability, nominal operating conditions should be selected so that operation is always within the following ranges:

CHARACTERISTIC	V _{DD} (V)	LIMITS		UNITS	
		Min.	Max.		
Supply Voltage Range (For T _A = Full Package-Temperature Range)		3	18	V	
Set or Clear Pulse Width, t _W	5	160	—	ns	
	10	90	—		
	15	60	—		
Clock Pulse Width, t _W	5	330	—	ns	
	10	170	—		
	15	100	—		
Clock Frequency, f _{CL}	5	—	1.2	MHz	
	10	dc	2.5		
	15	—	3.5		
Clock Rise or Fall Time, t _{rCL} or t _{fCL}	5,10,15	—	15	μs	
	Inhibit In Setup Time, t _{SU}	5	100	—	ns
		10	40	—	
15		20	—		
Inhibit In Removal Time, t _{REM}	5	240	—	ns	
	10	130	—		
	15	110	—		
Set Removal Time, t _{REM}	5	150	—	ns	
	10	80	—		
	15	50	—		
Clear Removal Time, t _{REM}	5	60	—	ns	
	10	40	—		
	15	30	—		

CD4527B Types

STATIC ELECTRICAL CHARACTERISTICS

CHARACTERISTIC	CONDITIONS			LIMITS AT INDICATED TEMPERATURES (°C)							UNITS
	V _O (V)	V _{IN} (V)	V _{DD} (V)					+25			
				-55	-40	+85	+125	Min.	Typ.	Max.	
Quiescent Device Current, I _{DD} Max.	-	0,5	5	5	5	150	150	-	0.04	5	μA
	-	0,10	10	10	10	300	300	-	0.04	10	
	-	0,15	15	20	20	600	600	-	0.04	20	
	-	0,20	20	100	100	3000	3000	-	0.08	100	
Output Low (Sink) Current I _{OL} Min.	0.4	0,5	5	0.64	0.61	0.42	0.36	0.51	1	-	mA
	0.5	0,10	10	1.6	1.5	1.1	0.9	1.3	2.6	-	
	1.5	0,15	15	4.2	4	2.8	2.4	3.4	6.8	-	
Output High (Source) Current, I _{OH} Min.	4.6	0,5	5	-0.64	-0.61	-0.42	-0.36	-0.51	-1	-	mA
	2.5	0,5	5	-2	-1.8	-1.3	-1.15	-1.6	-3.2	-	
	9.5	0,10	10	-1.6	-1.5	-1.1	-0.9	-1.3	-2.6	-	
Output Voltage: Low-Level, V _{OL} Max.	-	0,5	5	0.05				-	0	0.05	V
	-	0,10	10	0.05				-	0	0.05	
	-	0,15	15	0.05				-	0	0.05	
Output Voltage: High-Level, V _{OH} Min.	-	0,5	5	4.95				4.95	5	-	V
	-	0,10	10	9.95				9.95	10	-	
	-	0,15	15	14.95				14.95	15	-	
Input Low Voltage, V _{IL} Max.	0.5, 4.5	-	5	1.5				-	-	1.5	V
	1, 9	-	10	3				-	-	3	
	1.5, 13.5	-	15	4				-	-	4	
Input High Voltage, V _{IH} Min.	0.5, 4.5	-	5	3.5				3.5	-	-	V
	1, 9	-	10	7				7	-	-	
	1.5, 13.5	-	15	11				11	-	-	
Input Current I _{IN} Max.		0,18	18	±0.1	±0.1	±1	±1	-	±10 ⁻⁵	±0.1	μA

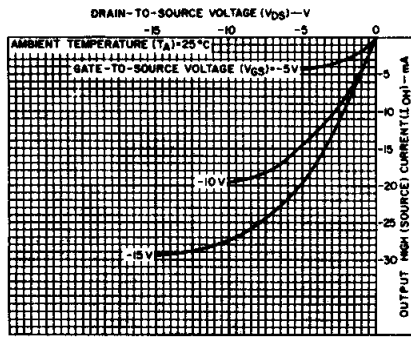

Fig. 3 - Typical output high (source) current characteristics.

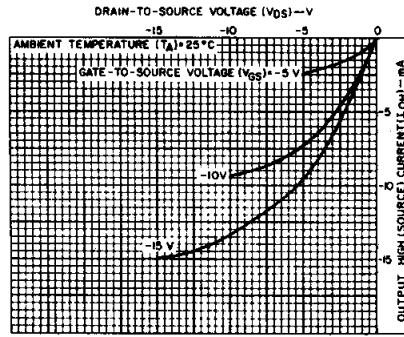

Fig. 4 - Minimum output high (source) current characteristics.

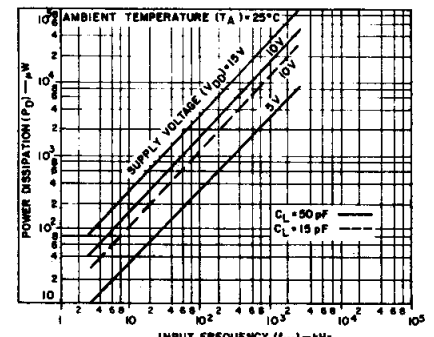

Fig. 5 - Typical dynamic power dissipation as a function of input frequency.

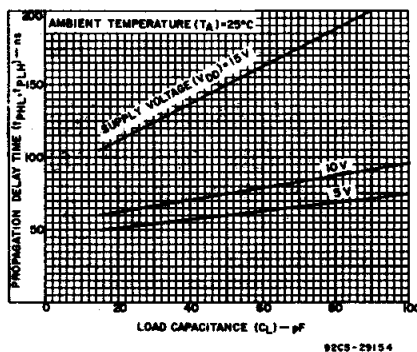

Fig. 6 - Typical propagation delay time as a function of load capacitance (Clock or Strobe to Out).

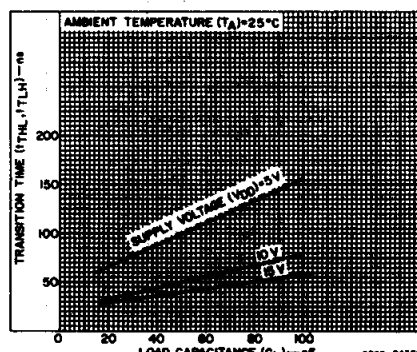

Fig. 7 - Typical transition time as a function of load capacitance.

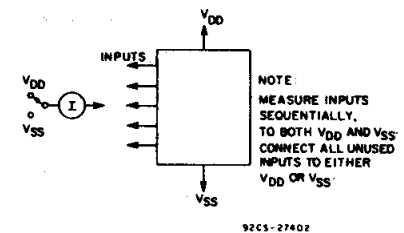

Fig. 8 - Input current test circuit.

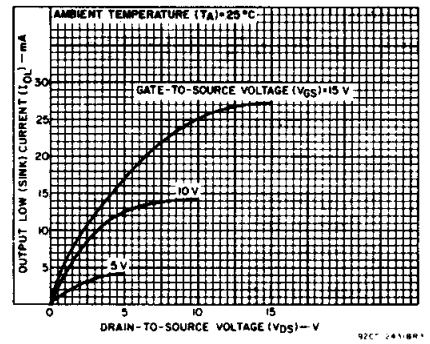

Fig. 1 - Typical output low (sink) current characteristics.

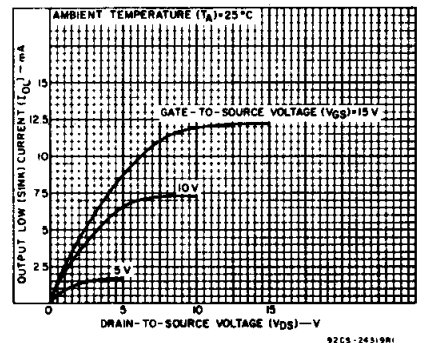

Fig. 2 - Minimum output low (sink) current characteristics.

3
COMMERCIAL CMOS
HIGH VOLTAGE ICs

CD4527B Types

DYNAMIC ELECTRICAL CHARACTERISTICS at T_A = 25°C:
 Input t_r, t_f = 20 ns, C_L = 50 pF, R_L = 200 kΩ

CHARACTERISTIC	TEST CONDITIONS	LIMITS			UNITS	
		V _{DD} (V)	Min.	Typ.		Max.
Propagation Delay Time, t _{PHL} , t _{PLH} Clock to Out		5	—	110	ns	
		10	—	55		
		15	—	45		
Clock or Strobe to Out		5	—	150	ns	
		10	—	75		
		15	—	60		
Clock to Inhibit Out High Level to Low Level		5	—	320	ns	
		10	—	145		
		15	—	100		
Low Level to High Level		5	—	250	ns	
		10	—	100		
		15	—	75		
Clear to Out		5	—	380	ns	
		10	—	175		
		15	—	130		
Clock to "9" or "15" Out		5	—	300	ns	
		10	—	125		
		15	—	90		
Cascade to Out		5	—	90	ns	
		10	—	45		
		15	—	35		
Inhibit In to Inhibit Out		5	—	130	ns	
		10	—	60		
		15	—	45		
Set to Out		5	—	330	ns	
		10	—	150		
		15	—	110		
Transition Time, t _{THL} , t _{TLH}		5	—	100	ns	
		10	—	50		
		15	—	40		
Maximum Clock Frequency, f _{CL}		5	1.2	2.4	MHz	
		10	2.5	5		
		15	3.5	7		
Minimum Clock Pulse Width, t _w		5	—	165	ns	
		10	—	85		
		15	—	50		
Clock Rise or Fall Time, t _{rCL} , t _{fCL}		5	—	15	μs	
		10	—	15		
		15	—	15		
Minimum Set or Clear Pulse Width, t _w		5	—	80	ns	
		10	—	45		
		15	—	30		
Minimum Inhibit In Setup Time, t _{SU}		5	—	50	ns	
		10	—	20		
		15	—	10		
Minimum Inhibit In Removal Time, t _{REM}		5	—	120	ns	
		10	—	65		
		15	—	55		
Minimum Set Removal Time, t _{REM}		5	—	75	ns	
		10	—	40		
		15	—	25		
Minimum Clear Removal Time, T _{REM}		5	—	30	ns	
		10	—	20		
		15	—	15		
Input Capacitance, C _{IN}	Any Input		—	5	7.5	pF

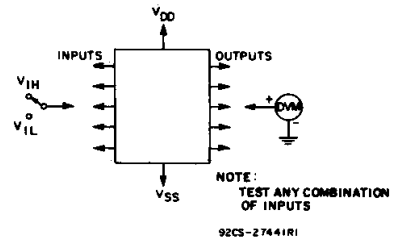

Fig. 9 - Input voltage test circuit.

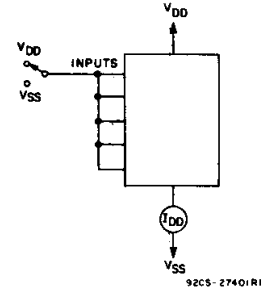

Fig. 10 - Quiescent device current test circuit.

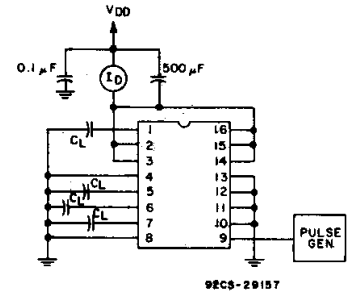

Fig. 11 - Dynamic power dissipation test circuit.

APPLICATIONS

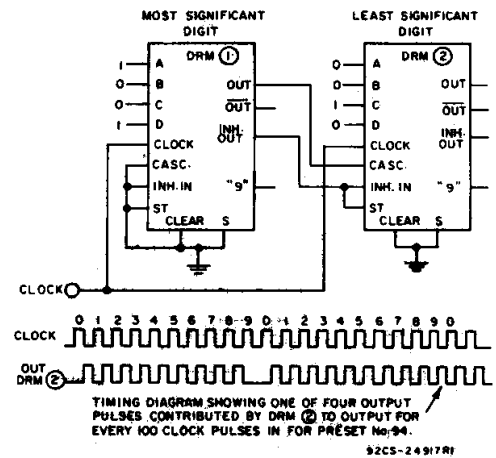

Fig. 12 - Two CD4527B's cascaded in the "Add" mode with a preset number

$$\text{of } 94 \left(\frac{9}{10} + \frac{4}{100} = \frac{94}{100} \right)$$

CD4527B Types

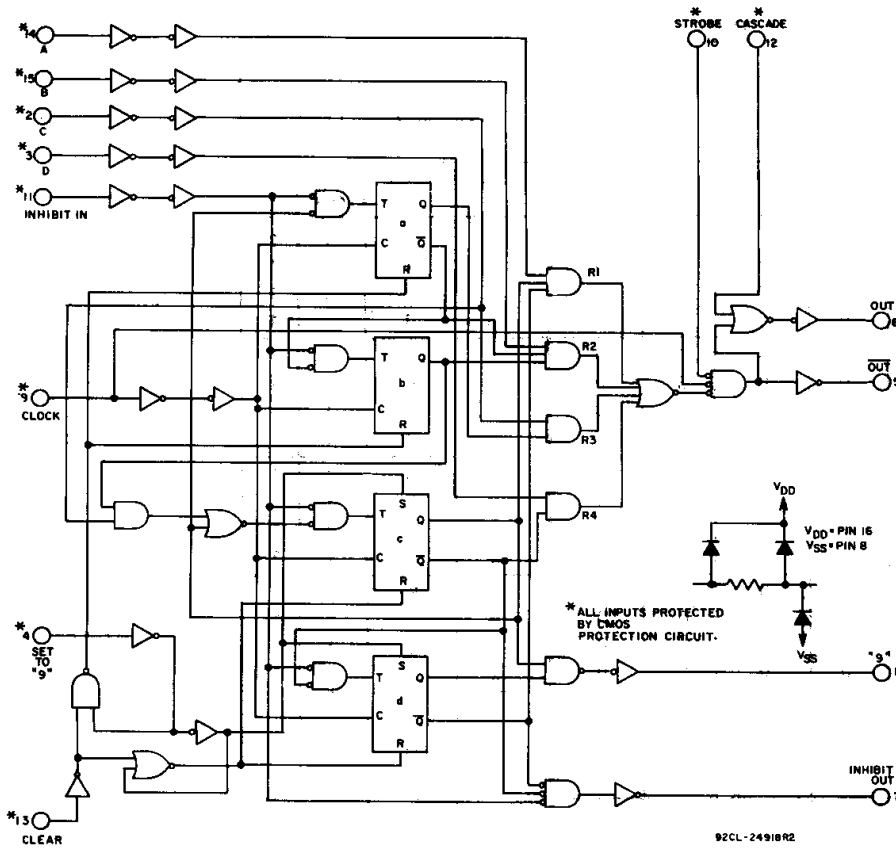

Fig. 13 - Logic diagram.

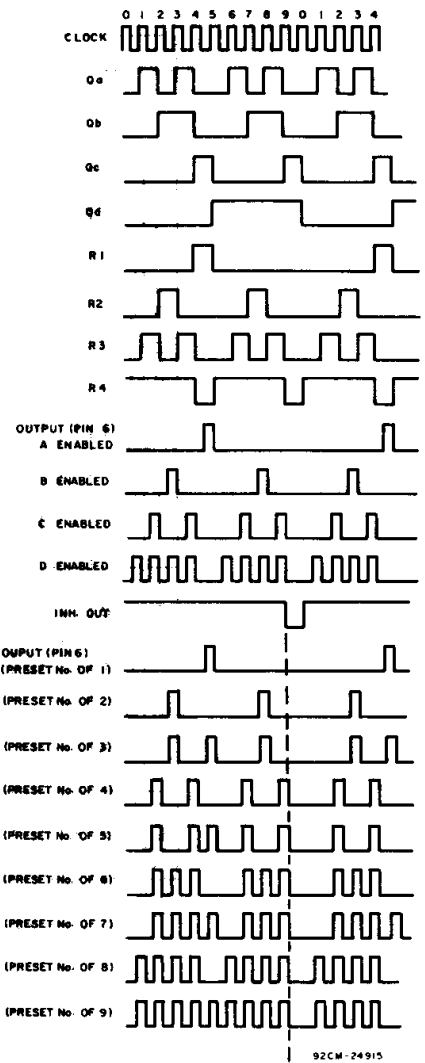
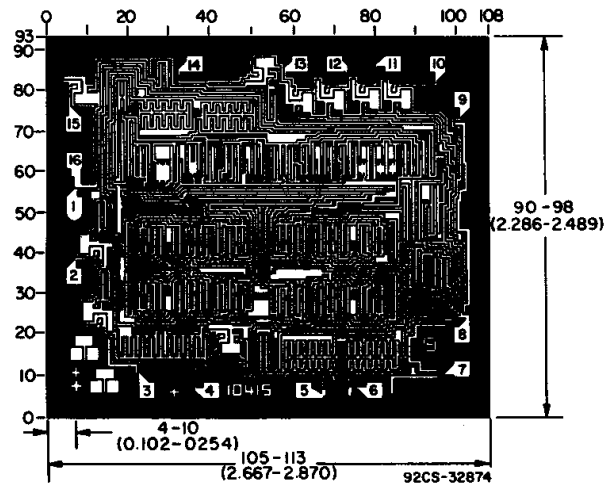

Fig. 14 - Timing diagram (See Logic Diagram).



Dimensions and Pad Layout for CD4527BH

Dimensions in parentheses are in millimeters and are derived from the basic inch dimensions as indicated. Grid graduations are in mils (10^{-3} inch).

3
COMMERCIAL CMOS
HIGH VOLTAGE ICs

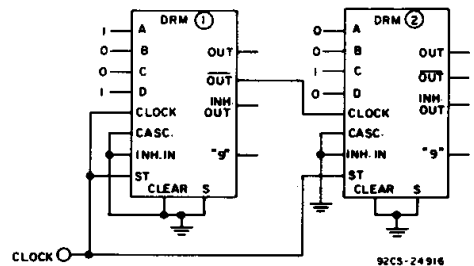

Fig. 15 - Two CD4527B's cascaded in the "Multiply" mode with a preset number

$$\text{of } 36 \left(\frac{9}{10} \times \frac{4}{10} = \frac{36}{100} \right)$$

CD4527B Types

TRUTH TABLE

INPUTS										OUTPUTS			
Number of Pulses or Input Logic Level (0 = Low; 1 = High; X = Don't Care)										Number of Pulses or Output Logic Level (L = Low; H = High)			
D	C	B	A	CLK	INH IN	STR	CAS	CLR #	SET #	OUT	$\overline{\text{OUT}}$	INH OUT	"9" OUT
0	0	0	0	10	0	0	0	0	0	L	H	1	1
0	0	0	1	10	0	0	0	0	0	1	1	1	1
0	0	1	0	10	0	0	0	0	0	2	2	1	1
0	0	1	1	10	0	0	0	0	0	3	3	1	1
0	1	0	0	10	0	0	0	0	0	4	4	1	1
0	1	0	1	10	0	0	0	0	0	5	5	1	1
0	1	1	0	10	0	0	0	0	0	6	6	1	1
0	1	1	1	10	0	0	0	0	0	7	7	1	1
1	0	0	0	10	0	0	0	0	0	8	8	1	1
1	0	0	1	10	0	0	0	0	0	9	9	1	1
1	0	1	0	10	0	0	0	0	0	8	8	1	1
1	0	1	1	10	0	0	0	0	0	9	9	1	1
1	1	0	0	10	0	0	0	0	0	8	8	1	1
1	1	0	1	10	0	0	0	0	0	9	9	1	1
1	1	1	0	10	0	0	0	0	0	8	8	1	1
1	1	1	1	10	0	0	0	0	0	9	9	1	1
X	X	X	X	10	1	0	0	0	0	†	†	H	†
X	X	X	X	10	0	1	0	0	0	L	H	1	1
X	X	X	X	10	0	0	1	0	0	H	*	1	1
1	X	X	X	10	0	0	0	1	0	10	10	H	L
0	X	X	X	10	0	0	0	1	0	L	H	H	L
X	X	X	X	10	0	0	0	0	1	L	H	L	H

* Output same as the first 16 lines of this truth table (depending on values of A, B, C, D).

† Depends on internal state of counter.

#Clear and Set Inputs should not be high at the same time; device draws increased quiescent current when in this non-valid state.

PACKAGING INFORMATION

Orderable Device	Status (1)	Package Type	Package Drawing	Pins	Package Qty	Eco Plan (2)	Lead/Ball Finish	MSL Peak Temp (3)	Op Temp (°C)	Top-Side Markings (4)	Samples
CD4527BE	ACTIVE	PDIP	N	16	25	Pb-Free (RoHS)	CU NIPDAU	N / A for Pkg Type	-55 to 125	CD4527BE	Samples
CD4527BEE4	ACTIVE	PDIP	N	16	25	Pb-Free (RoHS)	CU NIPDAU	N / A for Pkg Type	-55 to 125	CD4527BE	Samples
CD4527BNSR	ACTIVE	SO	NS	16	2000	Green (RoHS & no Sb/Br)	CU NIPDAU	Level-1-260C-UNLIM	-55 to 125	CD4527B	Samples
CD4527BNSRE4	ACTIVE	SO	NS	16	2000	Green (RoHS & no Sb/Br)	CU NIPDAU	Level-1-260C-UNLIM	-55 to 125	CD4527B	Samples
CD4527BNSRG4	ACTIVE	SO	NS	16	2000	Green (RoHS & no Sb/Br)	CU NIPDAU	Level-1-260C-UNLIM	-55 to 125	CD4527B	Samples
CD4527BPW	ACTIVE	TSSOP	PW	16	90	Green (RoHS & no Sb/Br)	CU NIPDAU	Level-1-260C-UNLIM	-55 to 125	CM527B	Samples
CD4527BPWE4	ACTIVE	TSSOP	PW	16	90	Green (RoHS & no Sb/Br)	CU NIPDAU	Level-1-260C-UNLIM	-55 to 125	CM527B	Samples
CD4527BPWG4	ACTIVE	TSSOP	PW	16	90	Green (RoHS & no Sb/Br)	CU NIPDAU	Level-1-260C-UNLIM	-55 to 125	CM527B	Samples
CD4527BPWR	ACTIVE	TSSOP	PW	16	2000	Green (RoHS & no Sb/Br)	CU NIPDAU	Level-1-260C-UNLIM	-55 to 125	CM527B	Samples
CD4527BPWRE4	ACTIVE	TSSOP	PW	16	2000	Green (RoHS & no Sb/Br)	CU NIPDAU	Level-1-260C-UNLIM	-55 to 125	CM527B	Samples
CD4527BPWRG4	ACTIVE	TSSOP	PW	16	2000	Green (RoHS & no Sb/Br)	CU NIPDAU	Level-1-260C-UNLIM	-55 to 125	CM527B	Samples

(1) The marketing status values are defined as follows:

ACTIVE: Product device recommended for new designs.

LIFEBUY: TI has announced that the device will be discontinued, and a lifetime-buy period is in effect.

NRND: Not recommended for new designs. Device is in production to support existing customers, but TI does not recommend using this part in a new design.

PREVIEW: Device has been announced but is not in production. Samples may or may not be available.

OBSOLETE: TI has discontinued the production of the device.

(2) Eco Plan - The planned eco-friendly classification: Pb-Free (RoHS), Pb-Free (RoHS Exempt), or Green (RoHS & no Sb/Br) - please check <http://www.ti.com/productcontent> for the latest availability information and additional product content details.

TBD: The Pb-Free/Green conversion plan has not been defined.

Pb-Free (RoHS): TI's terms "Lead-Free" or "Pb-Free" mean semiconductor products that are compatible with the current RoHS requirements for all 6 substances, including the requirement that lead not exceed 0.1% by weight in homogeneous materials. Where designed to be soldered at high temperatures, TI Pb-Free products are suitable for use in specified lead-free processes.

Pb-Free (RoHS Exempt): This component has a RoHS exemption for either 1) lead-based flip-chip solder bumps used between the die and package, or 2) lead-based die adhesive used between the die and leadframe. The component is otherwise considered Pb-Free (RoHS compatible) as defined above.

Green (RoHS & no Sb/Br): TI defines "Green" to mean Pb-Free (RoHS compatible), and free of Bromine (Br) and Antimony (Sb) based flame retardants (Br or Sb do not exceed 0.1% by weight in homogeneous material)

⁽³⁾ MSL, Peak Temp. -- The Moisture Sensitivity Level rating according to the JEDEC industry standard classifications, and peak solder temperature.

⁽⁴⁾ Multiple Top-Side Markings will be inside parentheses. Only one Top-Side Marking contained in parentheses and separated by a "~" will appear on a device. If a line is indented then it is a continuation of the previous line and the two combined represent the entire Top-Side Marking for that device.

Important Information and Disclaimer: The information provided on this page represents TI's knowledge and belief as of the date that it is provided. TI bases its knowledge and belief on information provided by third parties, and makes no representation or warranty as to the accuracy of such information. Efforts are underway to better integrate information from third parties. TI has taken and continues to take reasonable steps to provide representative and accurate information but may not have conducted destructive testing or chemical analysis on incoming materials and chemicals. TI and TI suppliers consider certain information to be proprietary, and thus CAS numbers and other limited information may not be available for release.

In no event shall TI's liability arising out of such information exceed the total purchase price of the TI part(s) at issue in this document sold by TI to Customer on an annual basis.

TAPE AND REEL INFORMATION



QUADRANT ASSIGNMENTS FOR PIN 1 ORIENTATION IN TAPE



*All dimensions are nominal

Device	Package Type	Package Drawing	Pins	SPQ	Reel Diameter (mm)	Reel Width W1 (mm)	A0 (mm)	B0 (mm)	K0 (mm)	P1 (mm)	W (mm)	Pin1 Quadrant
CD4527BNSR	SO	NS	16	2000	330.0	16.4	8.2	10.5	2.5	12.0	16.0	Q1
CD4527BPWR	TSSOP	PW	16	2000	330.0	12.4	6.9	5.6	1.6	8.0	12.0	Q1

TAPE AND REEL BOX DIMENSIONS

*All dimensions are nominal

Device	Package Type	Package Drawing	Pins	SPQ	Length (mm)	Width (mm)	Height (mm)
CD4527BNSR	SO	NS	16	2000	367.0	367.0	38.0
CD4527BPWR	TSSOP	PW	16	2000	367.0	367.0	35.0

N (R-PDIP-T**)

PLASTIC DUAL-IN-LINE PACKAGE

16 PINS SHOWN



- NOTES:
- A. All linear dimensions are in inches (millimeters).
 - B. This drawing is subject to change without notice.
 - C Falls within JEDEC MS-001, except 18 and 20 pin minimum body length (Dim A).
 - D The 20 pin end lead shoulder width is a vendor option, either half or full width.

4040049/E 12/2002

PW (R-PDSO-G16)

PLASTIC SMALL OUTLINE



- NOTES:
- A. All linear dimensions are in millimeters. Dimensioning and tolerancing per ASME Y14.5M-1994.
 - B. This drawing is subject to change without notice.
 - C. Body length does not include mold flash, protrusions, or gate burrs. Mold flash, protrusions, or gate burrs shall not exceed 0,15 each side.
 - D. Body width does not include interlead flash. Interlead flash shall not exceed 0,25 each side.
 - E. Falls within JEDEC MO-153

PW (R-PDSO-G16)

PLASTIC SMALL OUTLINE



- NOTES:
- A. All linear dimensions are in millimeters.
 - B. This drawing is subject to change without notice.
 - C. Publication IPC-7351 is recommended for alternate designs.
 - D. Laser cutting apertures with trapezoidal walls and also rounding corners will offer better paste release. Customers should contact their board assembly site for stencil design recommendations. Refer to IPC-7525 for other stencil recommendations.
 - E. Customers should contact their board fabrication site for solder mask tolerances between and around signal pads.

MECHANICAL DATA

NS (R-PDSO-G**)

PLASTIC SMALL-OUTLINE PACKAGE

14-PINS SHOWN



- NOTES:
- A. All linear dimensions are in millimeters.
 - B. This drawing is subject to change without notice.
 - C. Body dimensions do not include mold flash or protrusion, not to exceed 0,15.

IMPORTANT NOTICE

Texas Instruments Incorporated and its subsidiaries (TI) reserve the right to make corrections, enhancements, improvements and other changes to its semiconductor products and services per JESD46, latest issue, and to discontinue any product or service per JESD48, latest issue. Buyers should obtain the latest relevant information before placing orders and should verify that such information is current and complete. All semiconductor products (also referred to herein as "components") are sold subject to TI's terms and conditions of sale supplied at the time of order acknowledgment.

TI warrants performance of its components to the specifications applicable at the time of sale, in accordance with the warranty in TI's terms and conditions of sale of semiconductor products. Testing and other quality control techniques are used to the extent TI deems necessary to support this warranty. Except where mandated by applicable law, testing of all parameters of each component is not necessarily performed.

TI assumes no liability for applications assistance or the design of Buyers' products. Buyers are responsible for their products and applications using TI components. To minimize the risks associated with Buyers' products and applications, Buyers should provide adequate design and operating safeguards.

TI does not warrant or represent that any license, either express or implied, is granted under any patent right, copyright, mask work right, or other intellectual property right relating to any combination, machine, or process in which TI components or services are used. Information published by TI regarding third-party products or services does not constitute a license to use such products or services or a warranty or endorsement thereof. Use of such information may require a license from a third party under the patents or other intellectual property of the third party, or a license from TI under the patents or other intellectual property of TI.

Reproduction of significant portions of TI information in TI data books or data sheets is permissible only if reproduction is without alteration and is accompanied by all associated warranties, conditions, limitations, and notices. TI is not responsible or liable for such altered documentation. Information of third parties may be subject to additional restrictions.

Resale of TI components or services with statements different from or beyond the parameters stated by TI for that component or service voids all express and any implied warranties for the associated TI component or service and is an unfair and deceptive business practice. TI is not responsible or liable for any such statements.

Buyer acknowledges and agrees that it is solely responsible for compliance with all legal, regulatory and safety-related requirements concerning its products, and any use of TI components in its applications, notwithstanding any applications-related information or support that may be provided by TI. Buyer represents and agrees that it has all the necessary expertise to create and implement safeguards which anticipate dangerous consequences of failures, monitor failures and their consequences, lessen the likelihood of failures that might cause harm and take appropriate remedial actions. Buyer will fully indemnify TI and its representatives against any damages arising out of the use of any TI components in safety-critical applications.

In some cases, TI components may be promoted specifically to facilitate safety-related applications. With such components, TI's goal is to help enable customers to design and create their own end-product solutions that meet applicable functional safety standards and requirements. Nonetheless, such components are subject to these terms.

No TI components are authorized for use in FDA Class III (or similar life-critical medical equipment) unless authorized officers of the parties have executed a special agreement specifically governing such use.

Only those TI components which TI has specifically designated as military grade or "enhanced plastic" are designed and intended for use in military/aerospace applications or environments. Buyer acknowledges and agrees that any military or aerospace use of TI components which have **not** been so designated is solely at the Buyer's risk, and that Buyer is solely responsible for compliance with all legal and regulatory requirements in connection with such use.

TI has specifically designated certain components as meeting ISO/TS16949 requirements, mainly for automotive use. In any case of use of non-designated products, TI will not be responsible for any failure to meet ISO/TS16949.

Products

Audio	www.ti.com/audio
Amplifiers	amplifier.ti.com
Data Converters	dataconverter.ti.com
DLP® Products	www.dlp.com
DSP	dsp.ti.com
Clocks and Timers	www.ti.com/clocks
Interface	interface.ti.com
Logic	logic.ti.com
Power Mgmt	power.ti.com
Microcontrollers	microcontroller.ti.com
RFID	www.ti-rfid.com
OMAP Applications Processors	www.ti.com/omap
Wireless Connectivity	www.ti.com/wirelessconnectivity

Applications

Automotive and Transportation	www.ti.com/automotive
Communications and Telecom	www.ti.com/communications
Computers and Peripherals	www.ti.com/computers
Consumer Electronics	www.ti.com/consumer-apps
Energy and Lighting	www.ti.com/energy
Industrial	www.ti.com/industrial
Medical	www.ti.com/medical
Security	www.ti.com/security
Space, Avionics and Defense	www.ti.com/space-avionics-defense
Video and Imaging	www.ti.com/video

TI E2E Community

e2e.ti.com