

# CD4555B, CD4556B Types

## CMOS Dual Binary to 1 of 4 Decoder/Demultiplexers

High-Voltage Types (20-Volt Rating)

**CD4555B: Outputs High on Select**

**CD4556B: Outputs Low on Select**

■ CD4555B and CD4556B are dual one-of-four decoders/demultiplexers. Each decoder has two select inputs (A and B), an Enable input ( $\bar{E}$ ), and four mutually exclusive outputs. On the CD4555B the outputs are high on select; on the CD4556B the outputs are low on select.

When the Enable input is high, the outputs of the CD4555B remain low and the outputs of the CD4556B remain high regardless of the state of the select inputs A and B. The CD4555B and CD4556B are similar to types MC14555 and MC14556, respectively.

The CD4555B and CD4556B types are supplied in 16-lead hermetic dual-in-line ceramic packages (F3A suffix), 16-lead dual-in-line plastics packages (E suffix), and 16-lead small-outline packages (M, M96, and MT suffixes). The CD4555B is also supplied in 16-lead small-outline packages (NSR suffix) and 16-lead thin shrink small-outline packages (PW and PWR suffixes.)

### RECOMMENDED OPERATING CONDITIONS

For maximum reliability, nominal operating conditions should be selected so that operation is always within the following ranges.

CHARACTERISTIC	V <sub>DD</sub>	MIN.	MAX.	UNITS
Supply Voltage Range (For T <sub>A</sub> = Full Package Temp. Range)	—	3	18	V

### MAXIMUM RATINGS, Absolute-Maximum Values:

#### DC SUPPLY-VOLTAGE RANGE, (V<sub>DD</sub>)

Voltages referenced to V<sub>SS</sub> Terminal) ..... -0.5V to +20V

INPUT VOLTAGE RANGE, ALL INPUTS ..... -0.5V to V<sub>DD</sub> +0.5V

DC INPUT CURRENT, ANY ONE INPUT ..... ±10mA

#### POWER DISSIPATION PER PACKAGE (P<sub>D</sub>):

For T<sub>A</sub> = -55°C to +100°C ..... 500mW

For T<sub>A</sub> = +100°C to +125°C ..... Derate Linearly at 12mW/°C to 200mW

#### DEVICE DISSIPATION PER OUTPUT TRANSISTOR

FOR T<sub>A</sub> = FULL PACKAGE-TEMPERATURE RANGE (All Package Types)..... 100mW

OPERATING-TEMPERATURE RANGE (T<sub>A</sub>) ..... -55°C to +125°C

STORAGE TEMPERATURE RANGE (T<sub>stg</sub>) ..... -65°C to +150°C

#### LEAD TEMPERATURE (DURING SOLDERING):

At distance 1/16 ± 1/32 inch (1.59 ± 0.79mm) from case for 10s max ..... +265°C

### Features:

- Expandable with multiple packages
- Standard, symmetrical output characteristics
- 100% tested for quiescent current at 20 V
- Maximum input current of 1 μA at 18 V over full package temperature range; 100 nA at 18 V and 25°C
- Noise margin (full package-temperature range): 1 V at V<sub>DD</sub> = 5 V  
2 V at V<sub>DD</sub> = 10 V  
2.5 V at V<sub>DD</sub> = 15 V
- 5-V, 10-V, and 15-V parametric ratings
- Meets all requirements of JEDEC Tentative Standard No. 13B, "Standard Specifications for Description of 'B' Series CMOS Devices"

### Applications:

- Decoding      ■ Code conversion
- Demultiplexing (using Enable input as a data input)
- Memory chip-enable selection
- Function selection

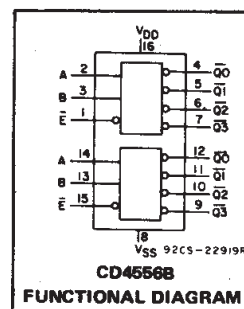
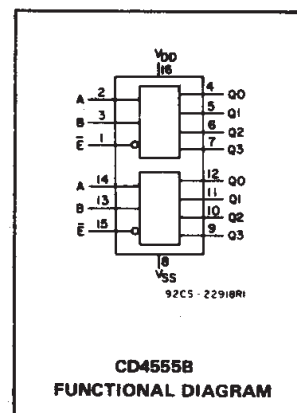

3  
COMMERCIAL CMOS  
HIGH VOLTAGE ICs

### TERMINAL ASSIGNMENTS

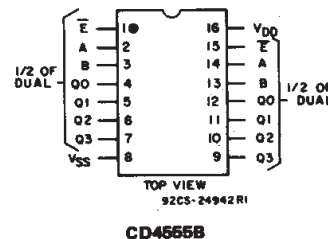
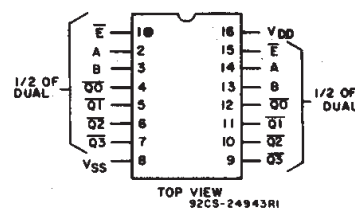

# CD4555B, CD4556B Types

## STATIC ELECTRICAL CHARACTERISTICS

CHARACTERISTIC	CONDITIONS			LIMITS AT INDICATED TEMPERATURES (°C)							UNITS
	V <sub>O</sub> (V)	V <sub>IN</sub> (V)	V <sub>DD</sub> (V)	-55	-40	+85	+125	+25			
								Min.	Typ.	Max.	
Quiescent Device Current, I <sub>DD</sub> Max.	—	0,5	5	5	5	150	150	—	0.04	5	μA
	—	0,10	10	10	10	300	300	—	0.04	10	
	—	0,15	15	20	20	600	600	—	0.04	20	
	—	0,20	20	100	100	3000	3000	—	0.08	100	
Output Low (Sink) Current I <sub>OL</sub> Min.	0,4	0,5	5	0.64	0.61	0.42	0.36	0.51	1	—	mA
	0,5	0,10	10	1.6	1.5	1.1	0.9	1.3	2.6	—	
	1,5	0,15	15	4.2	4	2.8	2.4	3.4	6.8	—	
Output High (Source) Current, I <sub>OH</sub> Min.	4,6	0,5	5	-0.64	-0.61	-0.42	-0.36	-0.51	-1	—	mA
	2,5	0,5	5	-2	-1.8	-1.3	-1.15	-1.6	-3.2	—	
	9,5	0,10	10	-1.6	-1.5	-1.1	-0.9	-1.3	-2.6	—	
Output Voltage: Low-Level, V <sub>OL</sub> Max.	—	0,5	5	0.05			—	0	0.05	—	V
	—	0,10	10	0.05			—	0	0.05	—	
	—	0,15	15	0.05			—	0	0.05	—	
Output Voltage: High-Level, V <sub>OH</sub> Min.	—	0,5	5	4.95			4.95	5	—	—	V
	—	0,10	10	9.95			9.95	10	—	—	
	—	0,15	15	14.95			14.95	15	—	—	
Input Low Voltage, V <sub>IL</sub> Max.	0,5,4,5	—	5	1.5			—	—	1.5	—	V
	1,9	—	10	3			—	—	3	—	
	1,5,13,5	—	15	4			—	—	4	—	
Input High Voltage, V <sub>IH</sub> Min.	0,5,4,5	—	5	3.5			3.5	—	—	—	V
	1,9	—	10	7			7	—	—	—	
	1,5,13,5	—	15	11			11	—	—	—	
Input Current I <sub>IN</sub> Max.		0,18	18	±0.1	±0.1	±1	±1	—	±10 <sup>-5</sup>	±0.1	μA

**DYNAMIC ELECTRICAL CHARACTERISTICS at T<sub>A</sub> = 25°C; Input t<sub>p</sub>, t<sub>f</sub> = 20 ns, C<sub>L</sub> = 50 pF, R<sub>L</sub> = 200 KΩ**

CHARACTERISTIC	TEST CONDITIONS	LIMITS		UNITS	
		V <sub>DD</sub> Volts	TYP.		MAX.
Propagation Delay Time, t <sub>PHL</sub> , A or B Input to t <sub>PLH</sub> Any Output		5	220	440	ns
		10	95	190	
		15	70	140	
E̅ Input to Any Output		5	200	400	ns
		10	85	170	
		15	65	130	
Transition Time t <sub>THL</sub> , t <sub>TLH</sub>		5	100	200	ns
		10	50	100	
		15	40	80	
Input Capacitance C <sub>IN</sub>	Any Input		5	7.5	pF

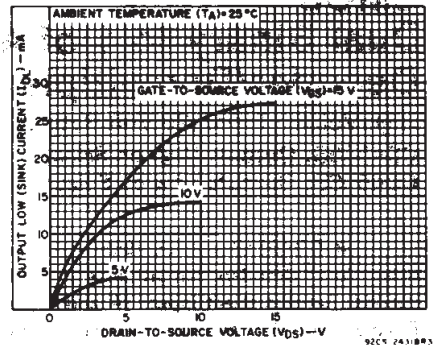

Fig. 1 — Typical output low (sink) current characteristics.

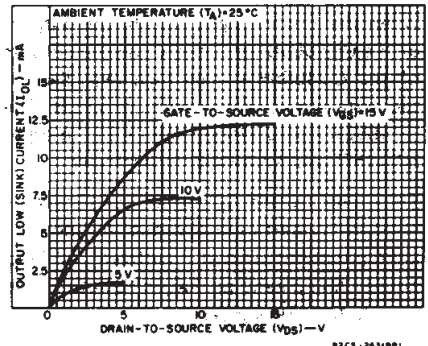

Fig. 2 — Minimum output low (sink) current characteristics.

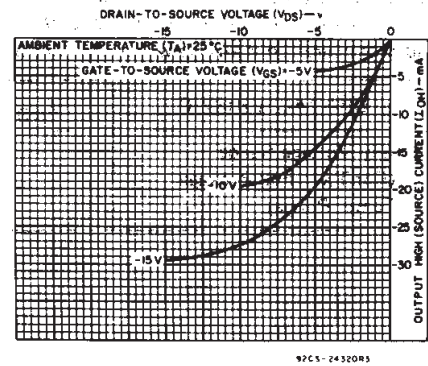

Fig. 3 — Typical output high (source) current characteristics.

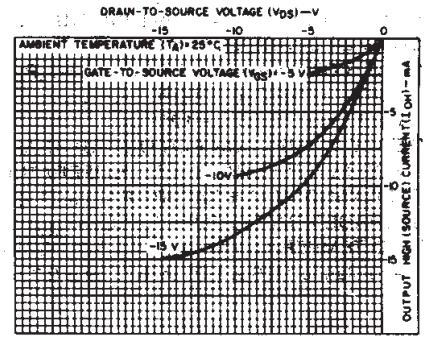

Fig. 4 — Minimum output high (source) current characteristics.

# CD4555B, CD4556B Types

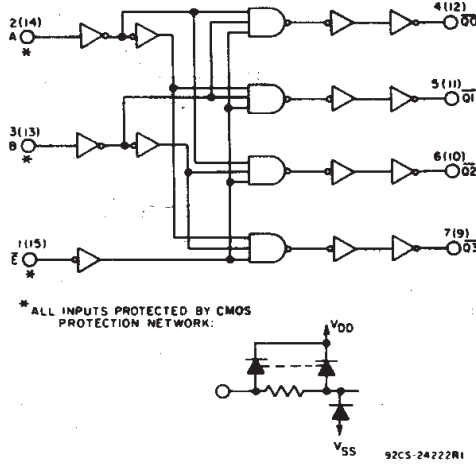

Fig. 5 - CD4556B logic diagram (1 of 2 identical circuits).

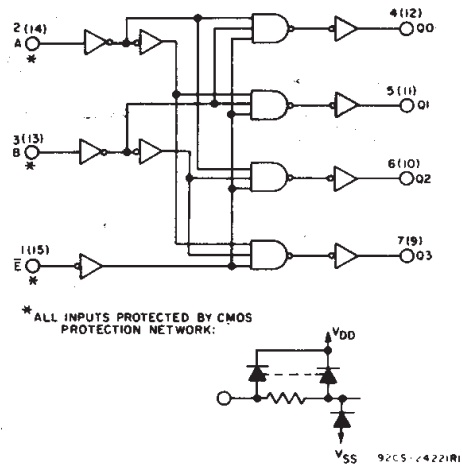

Fig. 6 - CD4555B logic diagram (1 of 2 identical circuits).

## TRUTH TABLE

INPUTS			OUTPUTS CD4555B				OUTPUTS CD4556B			
$\bar{E}$	B	A	Q3	Q2	Q1	Q0	$\bar{Q}3$	$\bar{Q}2$	$\bar{Q}1$	$\bar{Q}0$
0	0	0	0	0	0	1	1	1	1	0
0	0	1	0	0	1	0	1	1	0	1
0	1	0	0	1	0	0	1	0	1	1
0	1	1	1	0	0	0	0	1	1	1
1	X	X	0	0	0	0	1	1	1	1

X = DON'T CARE

LOGIC 1  $\equiv$  HIGH  
LOGIC 0  $\equiv$  LOW

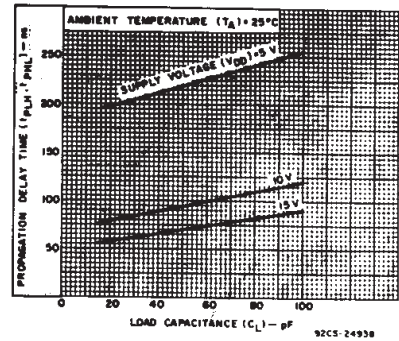

Fig. 7 - Typical propagation delay time vs. load capacitance (A or B input to any output).

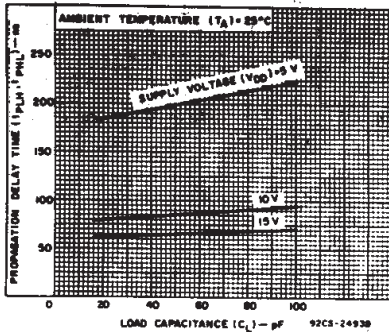

Fig. 8 - Typical propagation delay time vs. load capacitance (E input to any output).

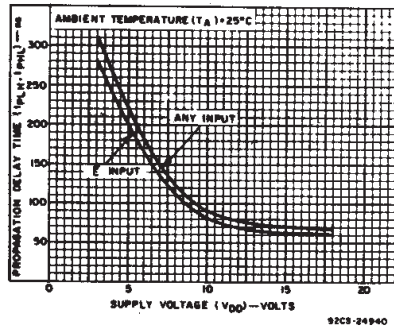

Fig. 9 - Typical propagation delay time vs. supply voltage.

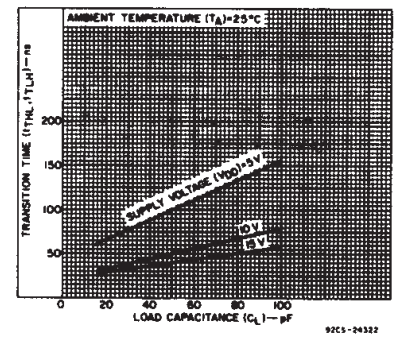

Fig. 10 - Typical transition time vs. load capacitance.

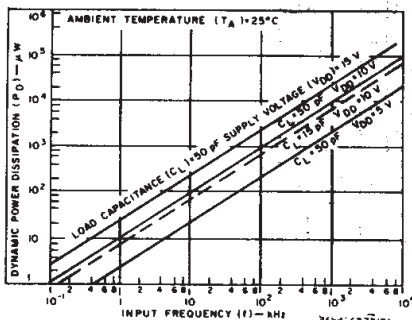

Fig. 11 - Typical dynamic power dissipation vs. frequency.

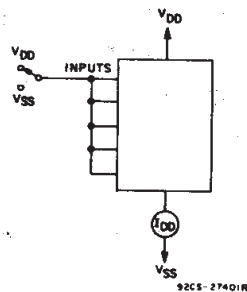

Fig. 12 - Quiescent device current test circuit.

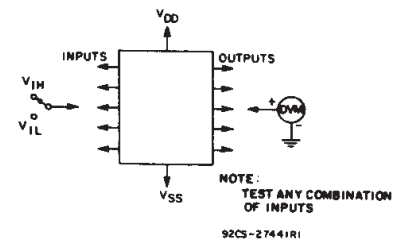

Fig. 13 - Input voltage test circuit.

3  
COMMERCIAL CMOS  
HIGH VOLTAGE ICs

# CD4555B, CD4556B Types

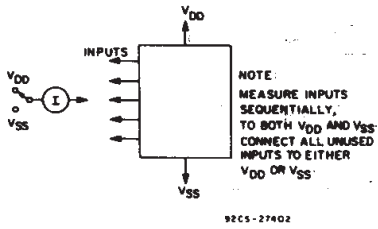

Fig. 14 - Input current test circuit.

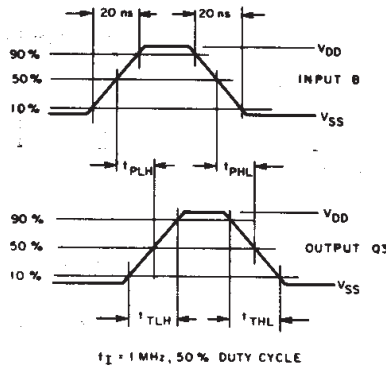

Fig. 15 - CD4555B B input to Q3 output dynamic signal waveforms.

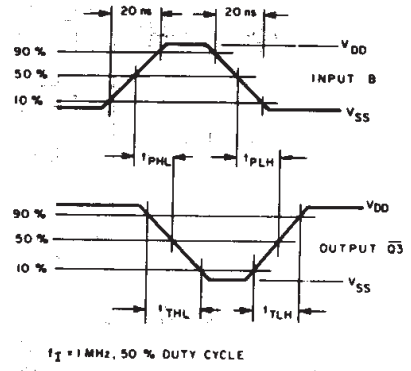

Fig. 16 - CD4556B B input to Q3 output dynamic signal waveforms.

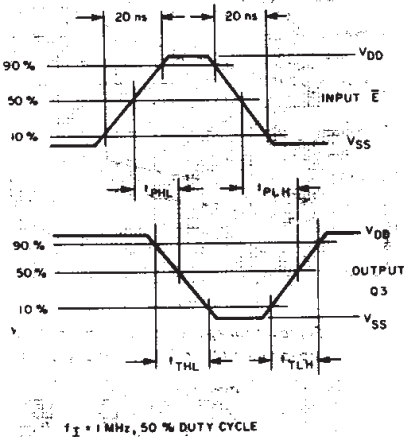

Fig. 17 - CD4555B E input to Q3 output dynamic signal waveforms.

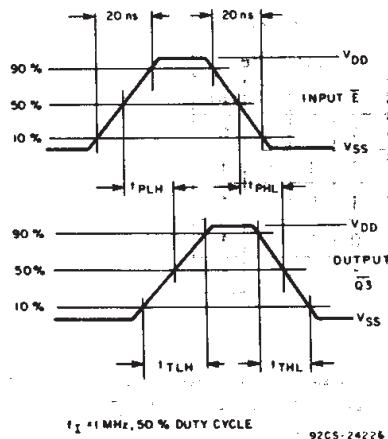
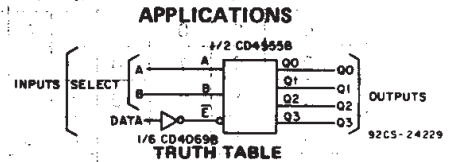

Fig. 18 - CD4556B E input to Q3 output dynamic signal waveforms.



TRUTH TABLE

SELECT INPUTS		OUTPUTS			
B	A	Q0	Q1	Q2	Q3
0	0	DATA	0	0	0
0	1	0	DATA	0	0
1	0	0	0	DATA	0
1	1	0	0	0	DATA

Fig. 19 - 1-of-4 line data demultiplexer using CD4555B.

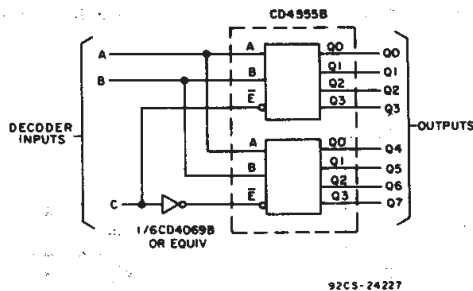

Fig. 20 - 1-of-8 decoder using CD4555B.

TRUTH TABLE

INPUTS			Q OUTPUTS							
C	B	A	0	1	2	3	4	5	6	7
0	0	0	1	0	0	0	0	0	0	0
0	0	1	0	1	0	0	0	0	0	0
0	1	0	0	0	1	0	0	0	0	0
0	1	1	0	0	0	1	0	0	0	0
1	0	0	0	0	0	0	1	0	0	0
1	0	1	0	0	0	0	0	1	0	0
1	1	0	0	0	0	0	0	0	1	0
1	1	1	0	0	0	0	0	0	0	1

# CD4555B, CD4556B Types

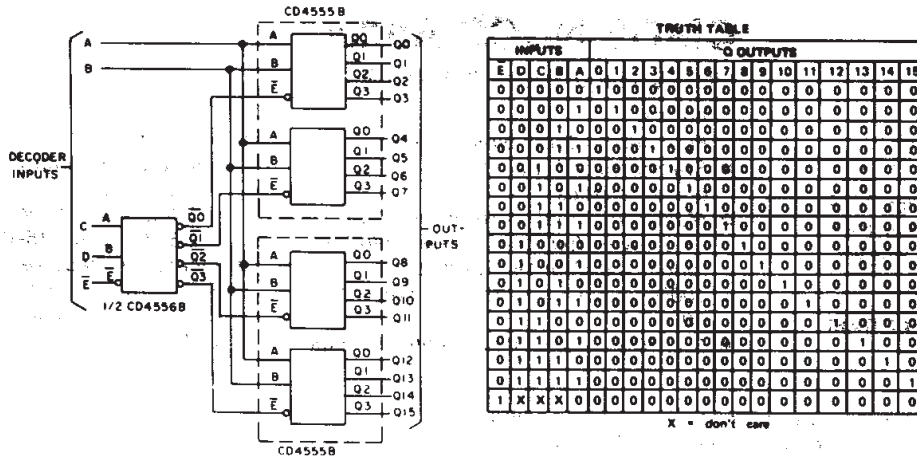
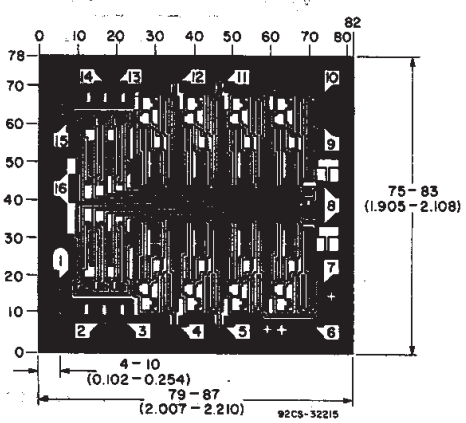
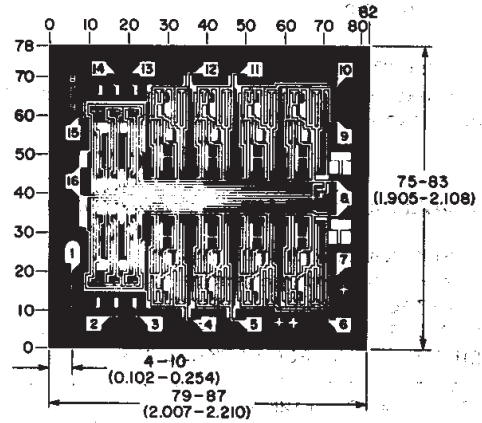

Fig. 21 - 1-of-16 decoder using CD4555B and CD4556B.



DIMENSIONS AND PAD LAYOUT FOR CD4555BH.



DIMENSIONS AND PAD LAYOUT FOR CD4556BH.

Dimensions in parentheses are in millimeters and are derived from the basic inch dimensions as indicated. Grid graduations are in mils (10<sup>-3</sup> inch).

3  
COMMERCIAL CMOS  
HIGH VOLTAGE ICs

**PACKAGING INFORMATION**

Orderable Device	Status (1)	Package Type	Package Drawing	Pins	Package Qty	Eco Plan (2)	Lead/Ball Finish	MSL Peak Temp (3)	Op Temp (°C)	Top-Side Markings (4)	Samples
7704701EA	ACTIVE	CDIP	J	16	1	TBD	Call TI	Call TI	-55 to 125	7704701EA CD4555BF3A	<a href="#">Samples</a>
7704801EA	ACTIVE	CDIP	J	16	1	TBD	Call TI	Call TI	-55 to 125	7704801EA CD4556BF3A	<a href="#">Samples</a>
CD4555BE	ACTIVE	PDIP	N	16	25	Pb-Free (RoHS)	CU NIPDAU	N / A for Pkg Type	-55 to 125	CD4555BE	<a href="#">Samples</a>
CD4555BEE4	ACTIVE	PDIP	N	16	25	Pb-Free (RoHS)	CU NIPDAU	N / A for Pkg Type	-55 to 125	CD4555BE	<a href="#">Samples</a>
CD4555BF3A	ACTIVE	CDIP	J	16	1	TBD	A42	N / A for Pkg Type	-55 to 125	7704701EA CD4555BF3A	<a href="#">Samples</a>
CD4555BM	ACTIVE	SOIC	D	16	40	Green (RoHS & no Sb/Br)	CU NIPDAU	Level-1-260C-UNLIM	-55 to 125	CD4555BM	<a href="#">Samples</a>
CD4555BM96	ACTIVE	SOIC	D	16	2500	Green (RoHS & no Sb/Br)	CU NIPDAU	Level-1-260C-UNLIM	-55 to 125	CD4555BM	<a href="#">Samples</a>
CD4555BM96E4	ACTIVE	SOIC	D	16	2500	Green (RoHS & no Sb/Br)	CU NIPDAU	Level-1-260C-UNLIM	-55 to 125	CD4555BM	<a href="#">Samples</a>
CD4555BM96G4	ACTIVE	SOIC	D	16	2500	Green (RoHS & no Sb/Br)	CU NIPDAU	Level-1-260C-UNLIM	-55 to 125	CD4555BM	<a href="#">Samples</a>
CD4555BME4	ACTIVE	SOIC	D	16	40	Green (RoHS & no Sb/Br)	CU NIPDAU	Level-1-260C-UNLIM	-55 to 125	CD4555BM	<a href="#">Samples</a>
CD4555BMG4	ACTIVE	SOIC	D	16	40	Green (RoHS & no Sb/Br)	CU NIPDAU	Level-1-260C-UNLIM	-55 to 125	CD4555BM	<a href="#">Samples</a>
CD4555BMT	ACTIVE	SOIC	D	16	250	Green (RoHS & no Sb/Br)	CU NIPDAU	Level-1-260C-UNLIM	-55 to 125	CD4555BM	<a href="#">Samples</a>
CD4555BMTE4	ACTIVE	SOIC	D	16	250	Green (RoHS & no Sb/Br)	CU NIPDAU	Level-1-260C-UNLIM	-55 to 125	CD4555BM	<a href="#">Samples</a>
CD4555BMTG4	ACTIVE	SOIC	D	16	250	Green (RoHS & no Sb/Br)	CU NIPDAU	Level-1-260C-UNLIM	-55 to 125	CD4555BM	<a href="#">Samples</a>
CD4555BNSR	ACTIVE	SO	NS	16	2000	Green (RoHS & no Sb/Br)	CU NIPDAU	Level-1-260C-UNLIM	-55 to 125	CD4555B	<a href="#">Samples</a>
CD4555BNSRE4	ACTIVE	SO	NS	16	2000	Green (RoHS & no Sb/Br)	CU NIPDAU	Level-1-260C-UNLIM	-55 to 125	CD4555B	<a href="#">Samples</a>
CD4555BNSRG4	ACTIVE	SO	NS	16	2000	Green (RoHS & no Sb/Br)	CU NIPDAU	Level-1-260C-UNLIM	-55 to 125	CD4555B	<a href="#">Samples</a>

Orderable Device	Status (1)	Package Type	Package Drawing	Pins	Package Qty	Eco Plan (2)	Lead/Ball Finish	MSL Peak Temp (3)	Op Temp (°C)	Top-Side Markings (4)	Samples
CD4555BPW	ACTIVE	TSSOP	PW	16	90	Green (RoHS & no Sb/Br)	CU NIPDAU	Level-1-260C-UNLIM	-55 to 125	CM555B	<a href="#">Samples</a>
CD4555BPWE4	ACTIVE	TSSOP	PW	16	90	Green (RoHS & no Sb/Br)	CU NIPDAU	Level-1-260C-UNLIM	-55 to 125	CM555B	<a href="#">Samples</a>
CD4555BPWG4	ACTIVE	TSSOP	PW	16	90	Green (RoHS & no Sb/Br)	CU NIPDAU	Level-1-260C-UNLIM	-55 to 125	CM555B	<a href="#">Samples</a>
CD4555BPWR	ACTIVE	TSSOP	PW	16	2000	Green (RoHS & no Sb/Br)	CU NIPDAU	Level-1-260C-UNLIM	-55 to 125	CM555B	<a href="#">Samples</a>
CD4555BPWRE4	ACTIVE	TSSOP	PW	16	2000	Green (RoHS & no Sb/Br)	CU NIPDAU	Level-1-260C-UNLIM	-55 to 125	CM555B	<a href="#">Samples</a>
CD4555BPWRG4	ACTIVE	TSSOP	PW	16	2000	Green (RoHS & no Sb/Br)	CU NIPDAU	Level-1-260C-UNLIM	-55 to 125	CM555B	<a href="#">Samples</a>
CD4556BE	ACTIVE	PDIP	N	16	25	Pb-Free (RoHS)	CU NIPDAU	N / A for Pkg Type	-55 to 125	CD4556BE	<a href="#">Samples</a>
CD4556BEE4	ACTIVE	PDIP	N	16	25	Pb-Free (RoHS)	CU NIPDAU	N / A for Pkg Type	-55 to 125	CD4556BE	<a href="#">Samples</a>
CD4556BF	ACTIVE	CDIP	J	16	1	TBD	A42	N / A for Pkg Type	-55 to 125	CD4556BF	<a href="#">Samples</a>
CD4556BF3A	ACTIVE	CDIP	J	16	1	TBD	A42	N / A for Pkg Type	-55 to 125	7704801EA CD4556BF3A	<a href="#">Samples</a>
CD4556BF3AS2283	OBSOLETE	CDIP	J	16		TBD	Call TI	Call TI			
CD4556BM	ACTIVE	SOIC	D	16	40	Green (RoHS & no Sb/Br)	CU NIPDAU	Level-1-260C-UNLIM	-55 to 125	CD4556BM	<a href="#">Samples</a>
CD4556BM96	ACTIVE	SOIC	D	16	2500	Green (RoHS & no Sb/Br)	CU NIPDAU	Level-1-260C-UNLIM	-55 to 125	CD4556BM	<a href="#">Samples</a>
CD4556BM96E4	ACTIVE	SOIC	D	16	2500	Green (RoHS & no Sb/Br)	CU NIPDAU	Level-1-260C-UNLIM	-55 to 125	CD4556BM	<a href="#">Samples</a>
CD4556BM96G4	ACTIVE	SOIC	D	16	2500	Green (RoHS & no Sb/Br)	CU NIPDAU	Level-1-260C-UNLIM	-55 to 125	CD4556BM	<a href="#">Samples</a>
CD4556BME4	ACTIVE	SOIC	D	16	40	Green (RoHS & no Sb/Br)	CU NIPDAU	Level-1-260C-UNLIM	-55 to 125	CD4556BM	<a href="#">Samples</a>
CD4556BMG4	ACTIVE	SOIC	D	16	40	Green (RoHS & no Sb/Br)	CU NIPDAU	Level-1-260C-UNLIM	-55 to 125	CD4556BM	<a href="#">Samples</a>
CD4556BMT	ACTIVE	SOIC	D	16	250	Green (RoHS & no Sb/Br)	CU NIPDAU	Level-1-260C-UNLIM	-55 to 125	CD4556BM	<a href="#">Samples</a>

Orderable Device	Status (1)	Package Type	Package Drawing	Pins	Package Qty	Eco Plan (2)	Lead/Ball Finish	MSL Peak Temp (3)	Op Temp (°C)	Top-Side Markings (4)	Samples
CD4556BMTE4	ACTIVE	SOIC	D	16	250	Green (RoHS & no Sb/Br)	CU NIPDAU	Level-1-260C-UNLIM	-55 to 125	CD4556BM	<a href="#">Samples</a>
CD4556BMTG4	ACTIVE	SOIC	D	16	250	Green (RoHS & no Sb/Br)	CU NIPDAU	Level-1-260C-UNLIM	-55 to 125	CD4556BM	<a href="#">Samples</a>

(1) The marketing status values are defined as follows:

**ACTIVE:** Product device recommended for new designs.

**LIFEBUY:** TI has announced that the device will be discontinued, and a lifetime-buy period is in effect.

**NRND:** Not recommended for new designs. Device is in production to support existing customers, but TI does not recommend using this part in a new design.

**PREVIEW:** Device has been announced but is not in production. Samples may or may not be available.

**OBSELETE:** TI has discontinued the production of the device.

(2) Eco Plan - The planned eco-friendly classification: Pb-Free (RoHS), Pb-Free (RoHS Exempt), or Green (RoHS & no Sb/Br) - please check <http://www.ti.com/productcontent> for the latest availability information and additional product content details.

**TBD:** The Pb-Free/Green conversion plan has not been defined.

**Pb-Free (RoHS):** TI's terms "Lead-Free" or "Pb-Free" mean semiconductor products that are compatible with the current RoHS requirements for all 6 substances, including the requirement that lead not exceed 0.1% by weight in homogeneous materials. Where designed to be soldered at high temperatures, TI Pb-Free products are suitable for use in specified lead-free processes.

**Pb-Free (RoHS Exempt):** This component has a RoHS exemption for either 1) lead-based flip-chip solder bumps used between the die and package, or 2) lead-based die adhesive used between the die and leadframe. The component is otherwise considered Pb-Free (RoHS compatible) as defined above.

**Green (RoHS & no Sb/Br):** TI defines "Green" to mean Pb-Free (RoHS compatible), and free of Bromine (Br) and Antimony (Sb) based flame retardants (Br or Sb do not exceed 0.1% by weight in homogeneous material)

(3) MSL, Peak Temp. -- The Moisture Sensitivity Level rating according to the JEDEC industry standard classifications, and peak solder temperature.

(4) Multiple Top-Side Markings will be inside parentheses. Only one Top-Side Marking contained in parentheses and separated by a "~" will appear on a device. If a line is indented then it is a continuation of the previous line and the two combined represent the entire Top-Side Marking for that device.

**Important Information and Disclaimer:** The information provided on this page represents TI's knowledge and belief as of the date that it is provided. TI bases its knowledge and belief on information provided by third parties, and makes no representation or warranty as to the accuracy of such information. Efforts are underway to better integrate information from third parties. TI has taken and continues to take reasonable steps to provide representative and accurate information but may not have conducted destructive testing or chemical analysis on incoming materials and chemicals. TI and TI suppliers consider certain information to be proprietary, and thus CAS numbers and other limited information may not be available for release.

In no event shall TI's liability arising out of such information exceed the total purchase price of the TI part(s) at issue in this document sold by TI to Customer on an annual basis.

**OTHER QUALIFIED VERSIONS OF CD4555B, CD4555B-MIL, CD4556B, CD4556B-MIL :**

- Catalog: [CD4555B](#), [CD4556B](#)



- Military: [CD4555B-MIL](#), [CD4556B-MIL](#)

NOTE: Qualified Version Definitions:

- Catalog - TI's standard catalog product
- Military - QML certified for Military and Defense Applications

**TAPE AND REEL INFORMATION**

**QUADRANT ASSIGNMENTS FOR PIN 1 ORIENTATION IN TAPE**

\*All dimensions are nominal

Device	Package Type	Package Drawing	Pins	SPQ	Reel Diameter (mm)	Reel Width W1 (mm)	A0 (mm)	B0 (mm)	K0 (mm)	P1 (mm)	W (mm)	Pin1 Quadrant
CD4555BM96	SOIC	D	16	2500	330.0	16.4	6.5	10.3	2.1	8.0	16.0	Q1
CD4555BNSR	SO	NS	16	2000	330.0	16.4	8.2	10.5	2.5	12.0	16.0	Q1
CD4555BPWR	TSSOP	PW	16	2000	330.0	12.4	6.9	5.6	1.6	8.0	12.0	Q1
CD4556BM96	SOIC	D	16	2500	330.0	16.4	6.5	10.3	2.1	8.0	16.0	Q1

**TAPE AND REEL BOX DIMENSIONS**

\*All dimensions are nominal

Device	Package Type	Package Drawing	Pins	SPQ	Length (mm)	Width (mm)	Height (mm)
CD4555BM96	SOIC	D	16	2500	333.2	345.9	28.6
CD4555BNSR	SO	NS	16	2000	367.0	367.0	38.0
CD4555BPWR	TSSOP	PW	16	2000	367.0	367.0	35.0
CD4556BM96	SOIC	D	16	2500	333.2	345.9	28.6

J (R-GDIP-T\*\*)

14 LEADS SHOWN

CERAMIC DUAL IN-LINE PACKAGE



DIM \ PINS **	14	16	18	20
A	0.300 (7,62) BSC	0.300 (7,62) BSC	0.300 (7,62) BSC	0.300 (7,62) BSC
B MAX	0.785 (19,94)	.840 (21,34)	0.960 (24,38)	1.060 (26,92)
B MIN	—	—	—	—
C MAX	0.300 (7,62)	0.300 (7,62)	0.310 (7,87)	0.300 (7,62)
C MIN	0.245 (6,22)	0.245 (6,22)	0.220 (5,59)	0.245 (6,22)



4040083/F 03/03

- NOTES:
- All linear dimensions are in inches (millimeters).
  - This drawing is subject to change without notice.
  - This package is hermetically sealed with a ceramic lid using glass frit.
  - Index point is provided on cap for terminal identification only on press ceramic glass frit seal only.
  - Falls within MIL STD 1835 GDIP1-T14, GDIP1-T16, GDIP1-T18 and GDIP1-T20.

N (R-PDIP-T\*\*)

PLASTIC DUAL-IN-LINE PACKAGE

16 PINS SHOWN



- NOTES:
- A. All linear dimensions are in inches (millimeters).
  - B. This drawing is subject to change without notice.
  - $\triangle C$  Falls within JEDEC MS-001, except 18 and 20 pin minimum body length (Dim A).
  - $\triangle D$  The 20 pin end lead shoulder width is a vendor option, either half or full width.

4040049/E 12/2002

D (R-PDSO-G16)

PLASTIC SMALL OUTLINE



4040047-6/M 06/11

- NOTES:
- A. All linear dimensions are in inches (millimeters).
  - B. This drawing is subject to change without notice.
  -  C. Body length does not include mold flash, protrusions, or gate burrs. Mold flash, protrusions, or gate burrs shall not exceed 0.006 (0,15) each side.
  -  D. Body width does not include interlead flash. Interlead flash shall not exceed 0.017 (0,43) each side.
  - E. Reference JEDEC MS-012 variation AC.

D (R-PDSO-G16)

PLASTIC SMALL OUTLINE



- NOTES:
- All linear dimensions are in millimeters.
  - This drawing is subject to change without notice.
  - Publication IPC-7351 is recommended for alternate designs.
  - Laser cutting apertures with trapezoidal walls and also rounding corners will offer better paste release. Customers should contact their board assembly site for stencil design recommendations. Refer to IPC-7525 for other stencil recommendations.
  - Customers should contact their board fabrication site for solder mask tolerances between and around signal pads.

PW (R-PDSO-G16)

PLASTIC SMALL OUTLINE



4040064-4/G 02/11

- NOTES:
- A. All linear dimensions are in millimeters. Dimensioning and tolerancing per ASME Y14.5M-1994.
  - B. This drawing is subject to change without notice.
  -  Body length does not include mold flash, protrusions, or gate burrs. Mold flash, protrusions, or gate burrs shall not exceed 0,15 each side.
  -  Body width does not include interlead flash. Interlead flash shall not exceed 0,25 each side.
  - E. Falls within JEDEC MO-153



PW (R-PDSO-G16)

PLASTIC SMALL OUTLINE



- NOTES:
- All linear dimensions are in millimeters.
  - This drawing is subject to change without notice.
  - Publication IPC-7351 is recommended for alternate designs.
  - Laser cutting apertures with trapezoidal walls and also rounding corners will offer better paste release. Customers should contact their board assembly site for stencil design recommendations. Refer to IPC-7525 for other stencil recommendations.
  - Customers should contact their board fabrication site for solder mask tolerances between and around signal pads.

## MECHANICAL DATA

**NS (R-PDSO-G\*\*)**

**PLASTIC SMALL-OUTLINE PACKAGE**

**14-PINS SHOWN**

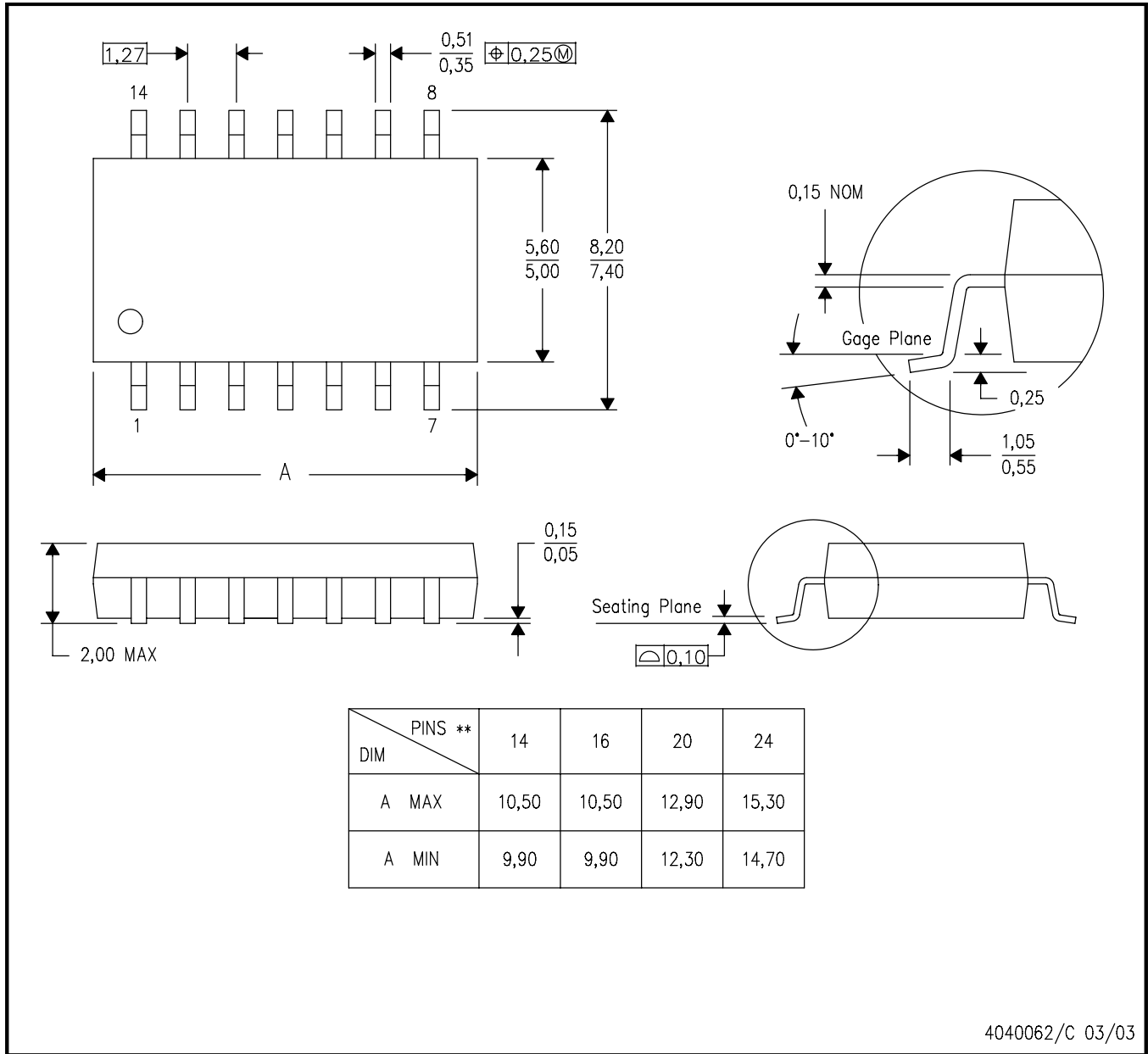

- NOTES:
- A. All linear dimensions are in millimeters.
  - B. This drawing is subject to change without notice.
  - C. Body dimensions do not include mold flash or protrusion, not to exceed 0,15.

## IMPORTANT NOTICE

Texas Instruments Incorporated and its subsidiaries (TI) reserve the right to make corrections, enhancements, improvements and other changes to its semiconductor products and services per JESD46, latest issue, and to discontinue any product or service per JESD48, latest issue. Buyers should obtain the latest relevant information before placing orders and should verify that such information is current and complete. All semiconductor products (also referred to herein as "components") are sold subject to TI's terms and conditions of sale supplied at the time of order acknowledgment.

TI warrants performance of its components to the specifications applicable at the time of sale, in accordance with the warranty in TI's terms and conditions of sale of semiconductor products. Testing and other quality control techniques are used to the extent TI deems necessary to support this warranty. Except where mandated by applicable law, testing of all parameters of each component is not necessarily performed.

TI assumes no liability for applications assistance or the design of Buyers' products. Buyers are responsible for their products and applications using TI components. To minimize the risks associated with Buyers' products and applications, Buyers should provide adequate design and operating safeguards.

TI does not warrant or represent that any license, either express or implied, is granted under any patent right, copyright, mask work right, or other intellectual property right relating to any combination, machine, or process in which TI components or services are used. Information published by TI regarding third-party products or services does not constitute a license to use such products or services or a warranty or endorsement thereof. Use of such information may require a license from a third party under the patents or other intellectual property of the third party, or a license from TI under the patents or other intellectual property of TI.

Reproduction of significant portions of TI information in TI data books or data sheets is permissible only if reproduction is without alteration and is accompanied by all associated warranties, conditions, limitations, and notices. TI is not responsible or liable for such altered documentation. Information of third parties may be subject to additional restrictions.

Resale of TI components or services with statements different from or beyond the parameters stated by TI for that component or service voids all express and any implied warranties for the associated TI component or service and is an unfair and deceptive business practice. TI is not responsible or liable for any such statements.

Buyer acknowledges and agrees that it is solely responsible for compliance with all legal, regulatory and safety-related requirements concerning its products, and any use of TI components in its applications, notwithstanding any applications-related information or support that may be provided by TI. Buyer represents and agrees that it has all the necessary expertise to create and implement safeguards which anticipate dangerous consequences of failures, monitor failures and their consequences, lessen the likelihood of failures that might cause harm and take appropriate remedial actions. Buyer will fully indemnify TI and its representatives against any damages arising out of the use of any TI components in safety-critical applications.

In some cases, TI components may be promoted specifically to facilitate safety-related applications. With such components, TI's goal is to help enable customers to design and create their own end-product solutions that meet applicable functional safety standards and requirements. Nonetheless, such components are subject to these terms.

No TI components are authorized for use in FDA Class III (or similar life-critical medical equipment) unless authorized officers of the parties have executed a special agreement specifically governing such use.

Only those TI components which TI has specifically designated as military grade or "enhanced plastic" are designed and intended for use in military/aerospace applications or environments. Buyer acknowledges and agrees that any military or aerospace use of TI components which have **not** been so designated is solely at the Buyer's risk, and that Buyer is solely responsible for compliance with all legal and regulatory requirements in connection with such use.

TI has specifically designated certain components as meeting ISO/TS16949 requirements, mainly for automotive use. In any case of use of non-designated products, TI will not be responsible for any failure to meet ISO/TS16949.

### Products

Audio	<a href="http://www.ti.com/audio">www.ti.com/audio</a>
Amplifiers	<a href="http://amplifier.ti.com">amplifier.ti.com</a>
Data Converters	<a href="http://dataconverter.ti.com">dataconverter.ti.com</a>
DLP® Products	<a href="http://www.dlp.com">www.dlp.com</a>
DSP	<a href="http://dsp.ti.com">dsp.ti.com</a>
Clocks and Timers	<a href="http://www.ti.com/clocks">www.ti.com/clocks</a>
Interface	<a href="http://interface.ti.com">interface.ti.com</a>
Logic	<a href="http://logic.ti.com">logic.ti.com</a>
Power Mgmt	<a href="http://power.ti.com">power.ti.com</a>
Microcontrollers	<a href="http://microcontroller.ti.com">microcontroller.ti.com</a>
RFID	<a href="http://www.ti-rfid.com">www.ti-rfid.com</a>
OMAP Applications Processors	<a href="http://www.ti.com/omap">www.ti.com/omap</a>
Wireless Connectivity	<a href="http://www.ti.com/wirelessconnectivity">www.ti.com/wirelessconnectivity</a>

### Applications

Automotive and Transportation	<a href="http://www.ti.com/automotive">www.ti.com/automotive</a>
Communications and Telecom	<a href="http://www.ti.com/communications">www.ti.com/communications</a>
Computers and Peripherals	<a href="http://www.ti.com/computers">www.ti.com/computers</a>
Consumer Electronics	<a href="http://www.ti.com/consumer-apps">www.ti.com/consumer-apps</a>
Energy and Lighting	<a href="http://www.ti.com/energy">www.ti.com/energy</a>
Industrial	<a href="http://www.ti.com/industrial">www.ti.com/industrial</a>
Medical	<a href="http://www.ti.com/medical">www.ti.com/medical</a>
Security	<a href="http://www.ti.com/security">www.ti.com/security</a>
Space, Avionics and Defense	<a href="http://www.ti.com/space-avionics-defense">www.ti.com/space-avionics-defense</a>
Video and Imaging	<a href="http://www.ti.com/video">www.ti.com/video</a>

### TI E2E Community

[e2e.ti.com](http://e2e.ti.com)