

February 1998 - Revised October 2003

High-Speed CMOS Logic Quad Analog Switch with Level Translation

Features

- **Wide Analog-Input-Voltage Range**
 $V_{CC} - V_{EE}$ 0V to 10V
- **Low "ON" Resistance**
 - 45Ω (Typ) $V_{CC} = 4.5V$
 - 35Ω (Typ) $V_{CC} = 6V$
 - 30Ω (Typ) $V_{CC} - V_{EE} = 9V$
- **Fast Switching and Propagation Delay Times**
- **Low "OFF" Leakage Current**
- **Built-In "Break-Before-Make" Switching**
- **Logic-Level Translation to Enable 5V Logic to Accommodate ±5V Analog Signals**
- **Wide Operating Temperature Range . . . -55°C to 125°C**
- **HC Types**
 - 2V to 10V Operation
 - **High Noise Immunity: $N_{IL} = 30\%$, $N_{IH} = 30\%$ of V_{CC} at $V_{CC} = 5V$**
- **HCT Types**
 - **Direct LSTTL Input Logic Compatibility, $V_{IL} = 0.8V$ (Max), $V_{IH} = 2V$ (Min)**
 - **CMOS Input Compatibility, $I_I \leq 1\mu A$ at V_{OL} , V_{OH}**

Description

The 'HC4316 and CD74HCT4316 contain four independent digitally controlled analog switches that use silicon-gate CMOS technology to achieve operating speeds similar to LSTTL with the low power consumption of standard CMOS integrated circuits.

In addition these devices contain logic-level translation circuits that provide for analog signal switching of voltages between $\pm 5V$ via 5V logic. Each switch is turned on by a high-level voltage on its select input (S) when the common Enable (E) is Low. A High E disables all switches. The digital inputs can swing between V_{CC} and GND; the analog inputs/outputs can swing between V_{CC} as a positive limit and V_{EE} as a negative limit. Voltage ranges are shown in Figures 2 and 3.

Ordering Information

PART NUMBER	TEMP. RANGE (°C)	PACKAGE
CD54HC4316F3A	-55 to 125	16 Ld CERDIP
CD74HC4316E	-55 to 125	16 Ld PDIP
CD74HC4316M	-55 to 125	16 Ld SOIC
CD74HC4316MT	-55 to 125	16 Ld SOIC
CD74HC4316M96	-55 to 125	16 Ld SOIC
CD74HC4316NSR	-55 to 125	16 Ld SOP
CD74HC4316PW	-55 to 125	16 Ld TSSOP
CD74HC4316PWR	-55 to 125	16 Ld TSSOP
CD74HC4316PWT	-55 to 125	16 Ld TSSOP
CD74HCT4316E	-55 to 125	16 Ld PDIP
CD74HCT4316M	-55 to 125	16 Ld SOIC
CD74HCT4316MT	-55 to 125	16 Ld SOIC
CD74HCT4316M96	-55 to 125	16 Ld SOIC

NOTE: When ordering, use the entire part number. The suffixes 96 and R denote tape and reel. The suffix T denotes a small-quantity reel of 250.

Pinout

CD54HC4316 (CERDIP)
 CD74HC4316 (PDIP, SOIC, SOP, TSSOP)
 CD74HCT4316 (PDIP, SOIC)

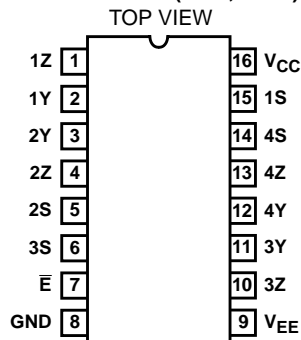

Functional Diagram

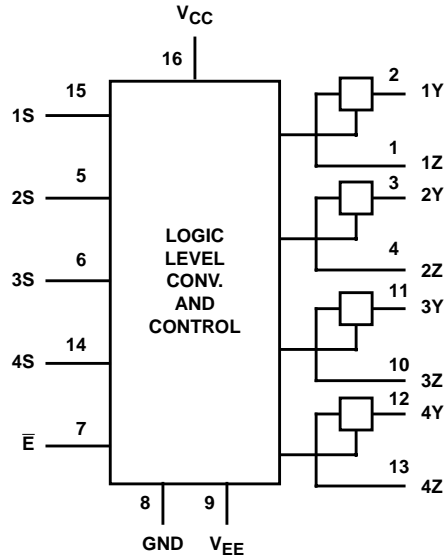

TRUTH TABLE

INPUTS		SWITCH
\bar{E}	S	
L	L	OFF
L	H	ON
H	X	OFF

H= High Level Voltage
 L= Low Level Voltage
 X= Don't Care

Logic Diagram

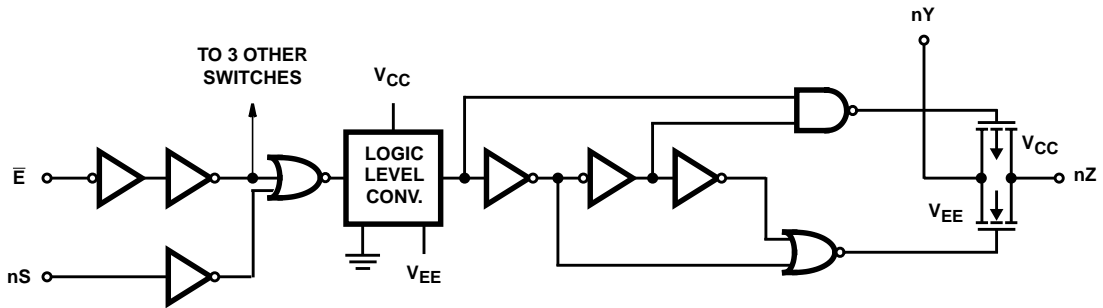

FIGURE 1. ONE SWITCH

CD54HC4316, CD74HC4316, CD74HCT4316

Absolute Maximum Ratings

DC Supply Voltage, V_{CC}	-0.5V to 7V
DC Supply Voltage, $V_{CC} - V_{EE}$	-0.5V to 10.5V
DC Supply Voltage, V_{EE}	0.5V to -7V
DC Input Diode Current, I_{IK} For $V_I < -0.5V$ or $V_I > V_{CC} + 0.5V$	$\pm 20mA$
DC Switch Diode Current, I_{OK} For $V_I < V_{EE} - 0.5V$ or $V_I < V_{CC} + 0.5V$	$\pm 25mA$
DC Switch Diode Current For $V_I > V_{EE} - 0.5V$ or $V_I < V_{CC} + 0.5V$	$\pm 25mA$
DC Output Diode Current, I_{OK} For $V_O < -0.5V$ or $V_O > V_{CC} + 0.5V$	$\pm 20mA$
DC Output Source or Sink Current per Output Pin, I_O For $V_O > -0.5V$ or $V_O < V_{CC} + 0.5V$	$\pm 25mA$
DC V_{CC} or Ground Current, I_{CC}	$\pm 50mA$

Operating Conditions

Temperature Range, T_A	-55°C to 125°C
Supply Voltage Range, V_{CC} HC Types2V to 6V
HCT Types	4.5V to 5.5V
Supply Voltage Range, $V_{CC} - V_{EE}$ HC, HCT Types (Figure 2)2V to 10V
Supply Voltage Range, V_{EE} HC, HCT Types (Figure 3)	0V to -6V
DC Input or Output Voltage, V_I	GND to V_{CC}
Analog Switch I/O Voltage, V_{IS}	V_{EE} (Min) V_{CC} (Max)
Input Rise and Fall Time, t_r, t_f 2V	1000ns (Max)
4.5V	500ns (Max)
6V	400ns (Max)

CAUTION: Stresses above those listed in "Absolute Maximum Ratings" may cause permanent damage to the device. This is a stress only rating and operation of the device at these or any other conditions above those indicated in the operational sections of this specification is not implied.

NOTE:

1. The package thermal impedance is calculated in accordance with JESD 51-7.

Thermal Information

Package Thermal Impedance, θ_{JA} (see Note 1):	
E (PDIP) Package	67°C/W
M (SOIC) Package	73°C/W
NS (SOP) Package	64°C/W
PW (TSSOP) Package	108°C/W
Maximum Junction Temperature (Plastic Package)	150°
Maximum Storage Temperature Range	-65°C to 150°
Maximum Lead Temperature (Soldering 10s)	300°
SOIC - Lead Tips Only	

Recommended Operating Area as a Function of Supply Voltage

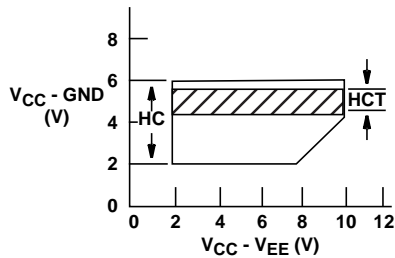

FIGURE 2.

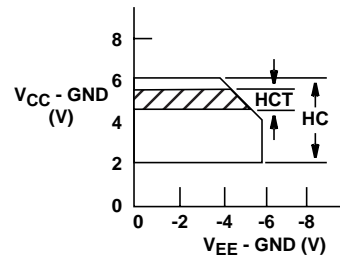

FIGURE 3.

CD54HC4316, CD74HC4316, CD74HCT4316

DC Electrical Specifications

PARAMETER	SYMBOL	TEST CONDITIONS				25°C			-40°C TO 85°C		-55°C TO 125°C		UNITS
		V _I (V)	V _{IS} (V)	V _{EE} (V)	V _{CC} (V)	MIN	TYP	MAX	MIN	MAX	MIN	MAX	
HC TYPES													
High Level Input Voltage	V _{IH}	-	-	-	2	1.5	-	-	1.5	-	1.5	-	V
					4.5	3.15	-	-	3.15	-	3.15	-	V
					6	4.2	-	-	4.2	-	4.2	-	V
Low Level Input Voltage	V _{IL}	-	-	-	2	-	-	0.5	-	0.5	-	0.5	V
					4.5	-	-	1.35	-	1.35	-	1.35	V
					6	-	-	1.8	-	1.8	-	1.8	V
“ON” Resistance I _O = 1mA (Figures 4, 5)	R _{ON}	V _{IH} or V _{IL}	V _{CC} or V _{EE}	0	4.5	-	45	180	-	225	-	270	Ω
				0	6	-	35	160	-	200	-	240	Ω
				-4.5	4.5	-	30	135	-	170	-	205	Ω
			V _{CC} to V _{EE}	0	4.5	-	85	320	-	400	-	480	Ω
				0	6	-	55	240	-	300	-	360	Ω
				-4.5	4.5	-	35	170	-	215	-	255	Ω
Maximum “ON” Resistance Between Any Two Channels	ΔR _{ON}	-	-	0	4.5	-	10	-	-	-	-	Ω	
				0	6	-	8.5	-	-	-	-	Ω	
				-4.5	4.5	-	5	-	-	-	-	Ω	
Switch Off Leakage Current	I _{IZ}	V _{IH} or V _{IL}	V _{CC} - V _{EE}	0	6	-	-	±0.1	-	±1	-	±1	μA
				-5	5	-	-	±0.1	-	±1	-	±1	μA
Control Input Leakage Current	I _{IL}	V _{CC} or GND	-	0	6	-	-	±0.1	-	±1	-	±1	μA
Quiescent Device Current I _O = 0	I _{CC}	V _{CC} or GND	When V _{IS} = V _{EE} , V _{OS} = V _{CC}	0	6	-	-	8	-	80	-	160	μA
				-5	5	-	-	16	-	160	-	320	μA
When V _{IS} = V _{CC} , V _{OS} = V _{EE}				0	6	-	-	8	-	80	-	160	μA
				-5	5	-	-	16	-	160	-	320	μA
HCT TYPES													
High Level Input Voltage	V _{IH}	-	-	-	4.5 to 5.5	2	-	-	2	-	2	-	V
Low Level Input Voltage	V _{IL}	-	-	-	4.5 to 5.5	-	-	0.8	-	0.8	-	0.8	V
“ON” Resistance I _O = 1mA (Figures 4, 5)	R _{ON}	V _{IH} or V _{IL}	V _{CC} or V _{EE}	0	4.5	-	45	180	-	225	-	270	Ω
				-4.5	4.5	-	30	135	-	170	-	205	Ω
			V _{CC} to V _{EE}	0	4.5	-	85	320	-	400	-	480	Ω
				-4.5	4.5	-	35	170	-	215	-	255	Ω
Maximum “ON” Resistance Between Any Two Channels	ΔR _{ON}	-	-	0	4.5	-	10	-	-	-	-	Ω	
				-4.5	4.5	-	5	-	-	-	-	Ω	
Switch Off Leakage Current	I _{IZ}	V _{IH} or V _{IL}	V _{CC} - V _{EE}	0	6	-	-	±0.1	-	±1	-	±1	μA
				-5	5	-	-	±0.1	-	±1	-	±1	μA

CD54HC4316, CD74HC4316, CD74HCT4316

DC Electrical Specifications (Continued)

PARAMETER	SYMBOL	TEST CONDITIONS				25°C			-40°C TO 85°C		-55°C TO 125°C		UNITS
		V _I (V)	V _{IS} (V)	V _{EE} (V)	V _{CC} (V)	MIN	TYP	MAX	MIN	MAX	MIN	MAX	
Control Input Leakage Current	I _I	V _{CC} or GND	-	0	5.5	-	-	±0.1	-	±1	-	±1	μA
Quiescent Device Current I _O = 0	I _{CC}	Any Voltage Between V _{CC} and GND	When V _{IS} = V _{EE} , V _{OS} = V _{CC}	0	5.5	-	-	8	-	80	-	160	μA
			When V _{IS} = V _{CC} , V _{OS} = V _{EE}	-4.5	5.5	-	-	16	-	160	-	320	μA
Additional Quiescent Device Current Per Input Pin: 1 Unit Load	ΔI _{CC} (Note 2)	V _{CC} -2.1	-	-	4.5 to 5.5	-	100	360	-	450	-	490	μA

NOTE:

- For dual-supply systems theoretical worst case (V_I = 2.4V, V_{CC} = 5.5V) specification is 1.8mA.

HCT Input Loading Table

INPUT	UNIT LOADS
All	0.5

NOTE: Unit Load is ΔI_{CC} limit specified in DC Electrical Table, e.g., 360μA max at 25°C.

Switching Specifications Input t_r, t_f = 6ns

PARAMETER	SYMBOL	TEST CONDITIONS	V _{EE} (V)	V _{CC} (V)	25°C			-40°C TO 85°C		-55°C TO 125°C		UNITS
					MIN	TYP	MAX	MIN	MAX	MIN	MAX	
HC TYPES												
Propagation Delay, Switch In to Out	t _{PLH} , t _{PHL}	C _L = 50pF	0	2	-	-	60	-	75	-	90	ns
			0	4.5	-	-	12	-	15	-	18	ns
			0	6	-	-	10	-	13	-	15	ns
			-4.5	4.5	-	-	8	-	10	-	12	ns
Turn "ON" Time \bar{E} to Out	t _{PZH} , t _{PZL}	C _L = 50pF	0	2	-	-	205	-	255	-	310	ns
			0	4.5	-	-	41	-	51	-	62	ns
			0	6	-	-	35	-	43	-	53	ns
			-4.5	4.5	-	-	37	-	47	-	56	ns
		C _L = 15pF	-	5	-	17	-	-	-	-	-	ns
Turn "ON" Time nS to Out	t _{PZH} , t _{PZL}	C _L = 50pF	0	2	-	-	175	-	220	-	265	ns
			0	4.5	-	-	35	-	44	-	53	ns
			0	6	-	-	30	-	37	-	45	ns
			-4.5	4.5	-	-	34	-	43	-	51	ns
		C _L = 15pF	-	5	-	14	-	-	-	-	-	ns
Turn "OFF" Time \bar{E} to Out	t _{PLZ} , t _{PHZ}	C _L = 50pF	0	2	-	-	205	-	255	-	310	ns
			0	4.5	-	-	41	-	51	-	62	ns
			0	6	-	-	35	-	43	-	53	ns
			-4.5	4.5	-	-	37	-	47	-	56	ns
		C _L = 15pF	-	5	-	17	-	-	-	-	-	ns

CD54HC4316, CD74HC4316, CD74HCT4316

Switching Specifications Input $t_r, t_f = 6\text{ns}$ (Continued)

PARAMETER	SYMBOL	TEST CONDITIONS	V _{EE} (V)	V _{CC} (V)	25°C			-40°C TO 85°C		-55°C TO 125°C		UNITS
					MIN	TYP	MAX	MIN	MAX	MIN	MAX	
Turn "OFF" Time nS to Out	t _{PLZ} , t _{PHZ}	C _L = 50pF	0	2	-	-	175	-	220	-	265	ns
			0	4.5	-	-	35	-	44	-	53	ns
			0	6	-	-	30	-	37	-	45	ns
			-4.5	4.5	-	-	34	-	43	-	51	ns
		C _L = 15pF	-	5	-	14	-	-	-	-	-	ns
Input (Control) Capacitance	C _I	-	-	-	-	10	-	10	-	10	pF	
Power Dissipation Capacitance (Notes 3, 4)	C _{PD}	-	-	5	-	42	-	-	-	-	pF	
HCT TYPES												
Propagation Delay, Switch In to Switch Out	t _{PLH} , t _{PHL}	C _L = 50pF	0	4.5	-	-	12	-	15	-	18	ns
			-4.5	4.5	-	-	8	-	10	-	12	ns
Turn "ON" Time \bar{E} to Out	t _{PZH}	C _L = 50pF	0	4.5	-	-	44	-	55	-	66	ns
			-4.5	4.5	-	-	42	-	53	-	63	ns
		C _L = 15pF	-	5	-	18	-	-	-	-	-	ns
	t _{PZL}	C _L = 50pF	0	4.5	-	-	56	-	70	-	85	ns
			-4.5	4.5	-	-	42	-	53	-	63	ns
		C _L = 15pF	-	5	-	24	-	-	-	-	-	ns
Turn "ON" Time nS to Out	t _{PZH}	C _L = 50pF	0	4.5	-	-	40	-	53	-	60	ns
			-4.5	4.5	-	-	34	-	43	-	51	ns
		C _L = 15pF	-	5	-	17	-	-	-	-	-	ns
	t _{PZL}	C _L = 50pF	0	4.5	-	-	50	-	63	-	75	ns
			-4.5	4.5	-	-	34	-	43	-	51	ns
		C _L = 15pF	-	5	-	18	-	-	-	-	-	ns
Turn "OFF" Time \bar{E} to Out	t _{PLZ}	C _L = 50pF	0	4.5	-	-	50	-	63	-	75	ns
			-4.5	4.5	-	-	46	-	58	-	69	ns
	t _{PLZ} , t _{PHZ}	C _L = 15pF	-	5	-	21	-	-	-	-	-	ns
			-	5	-	21	-	-	-	-	-	ns
Turn "OFF" Time nS to Out	t _{PHZ}	C _L = 50pF	0	4.5	-	-	44	-	55	-	66	ns
			-4.5	4.5	-	-	40	-	50	-	60	ns
	t _{PLZ} , t _{PHZ}	C _L = 15pF	-	5	-	18	-	-	-	-	-	ns
			-	5	-	18	-	-	-	-	-	ns
Input (Control) Capacitance	C _I	-	-	-	-	10	-	10	-	10	pF	
Power Dissipation Capacitance (Notes 3, 4)	C _{PD}	-	-	5	-	47	-	-	-	-	pF	

NOTES:

- C_{PD} is used to determine the dynamic power consumption, per package.
- $P_D = C_{PD} V_{CC}^2 f_i + \sum (C_L + C_S) V_{CC}^2 f_o$ where f_i = input frequency, f_o = output frequency, C_L = output load capacitance, C_S = switch capacitance, V_{CC} = supply voltage.

Analog Channel Specifications T_A = 25°C

PARAMETER	TEST CONDITIONS	V _{CC} (V)	HC4316	CD74HCT4316	UNITS
Switch Frequency Response Bandwidth at -3dB (Figure 6)	Figure 9 (Notes 5, 6)	4.5	>200	>200	MHz
Crosstalk Between Any Two Switches (Figure 7)	Figure 8 (Notes 6, 7)	4.5	TBE	TBE	dB

CD54HC4316, CD74HC4316, CD74HCT4316

Analog Channel Specifications $T_A = 25^\circ\text{C}$ (Continued)

PARAMETER	TEST CONDITIONS	V_{CC} (V)	HC4316	CD74HCT4316	UNITS
Total Harmonic Distortion	1kHz, $V_{IS} = 4V_{P-P}$ (Figure 10)	4.5	0.078	0.078	%
	1kHz, $V_{IS} = 8V_{P-P}$ (Figure 10)	9	0.018	0.018	%
Control to Switch Feedthrough Noise	Figure 11	4.5	TBE	TBE	mV
		9	TBE	TBE	mV
Switch "OFF" Signal Feedthrough (Figure 7)	Figure 12 (Notes 6, 7)	4.5	-62	-62	dB
Switch Input Capacitance, C_S	-	-	5	5	pF

NOTES:

5. Adjust input level for 0dBm at output, $f = 1\text{MHz}$.
6. V_{IS} is centered at $V_{CC}/2$.
7. Adjust input for 0dBm at V_{IS} .

Typical Performance Curves

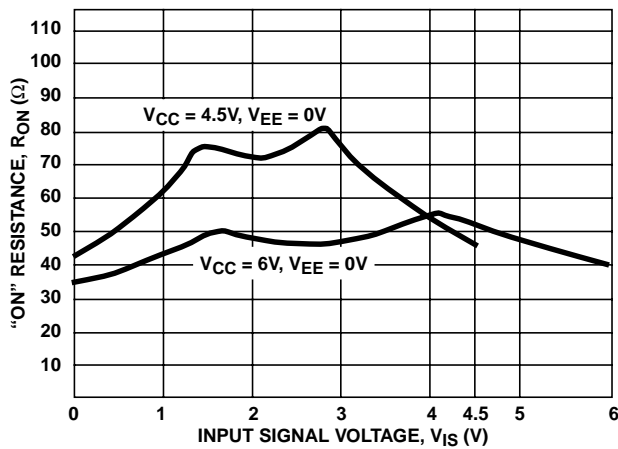

FIGURE 4. TYPICAL "ON" RESISTANCE vs INPUT SIGNAL VOLTAGE

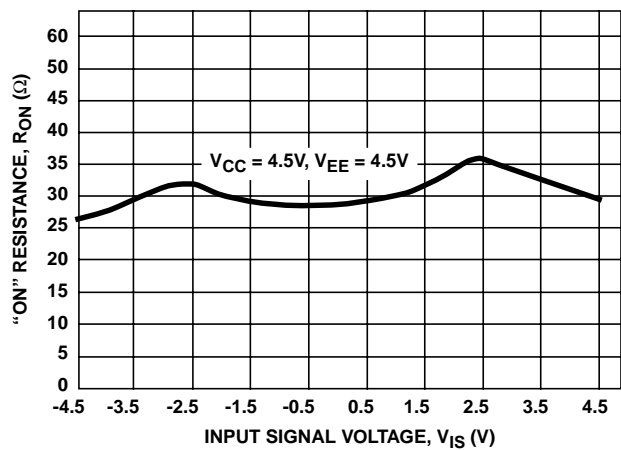

FIGURE 5. TYPICAL "ON" RESISTANCE vs INPUT SIGNAL VOLTAGE

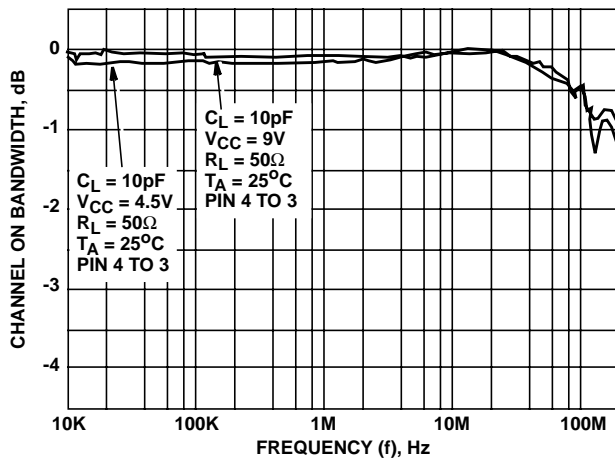

FIGURE 6. SWITCH FREQUENCY RESPONSE

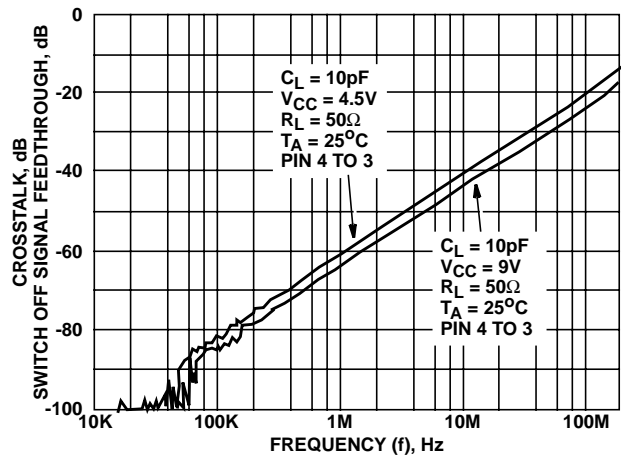

FIGURE 7. SWITCH-OFF SIGNAL FEEDTHROUGH AND CROSSTALK vs FREQUENCY

Analog Test Circuits

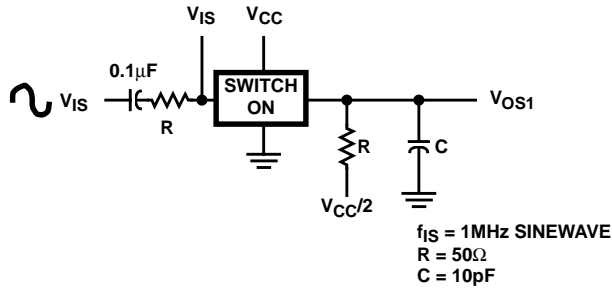

FIGURE 8. CROSTALK BETWEEN TWO SWITCHES TEST CIRCUIT

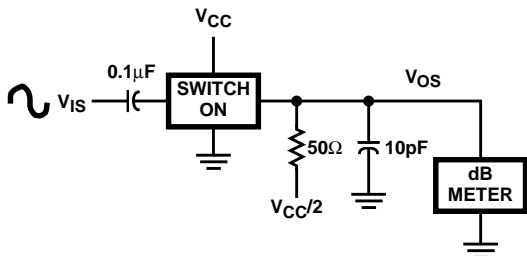
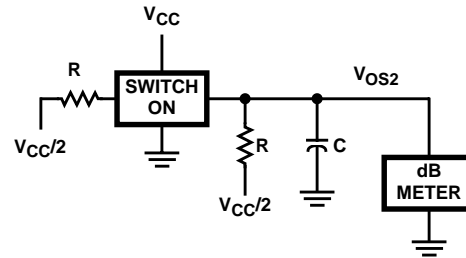

FIGURE 9. FREQUENCY RESPONSE TEST CIRCUIT

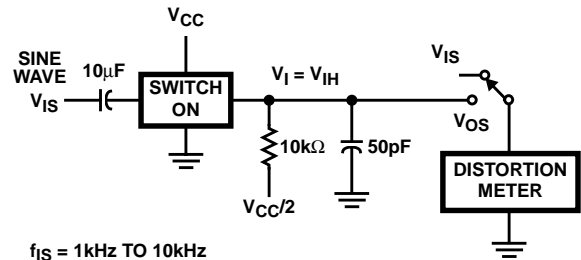

FIGURE 10. TOTAL HARMONIC DISTORTION TEST CIRCUIT

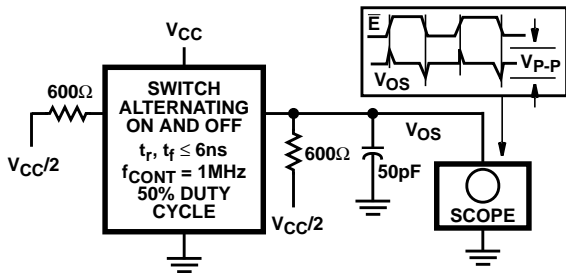

FIGURE 11. CONTROL-TO-SWITCH FEEDTHROUGH NOISE TEST CIRCUIT

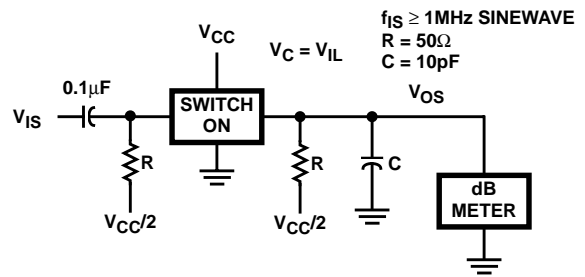

FIGURE 12. SWITCH OFF SIGNAL FEEDTHROUGH

Test Circuits and Waveforms

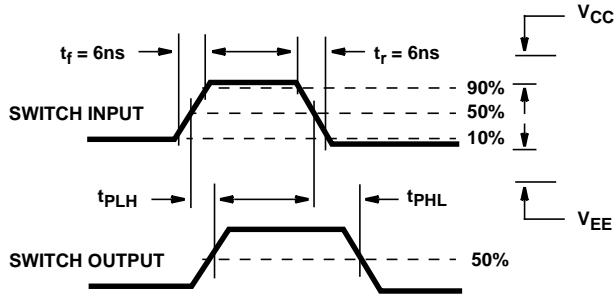

FIGURE 13. SWITCH PROPAGATION DELAY TIMES

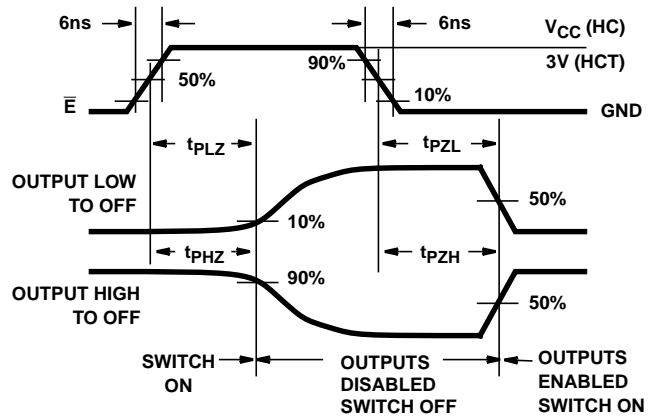
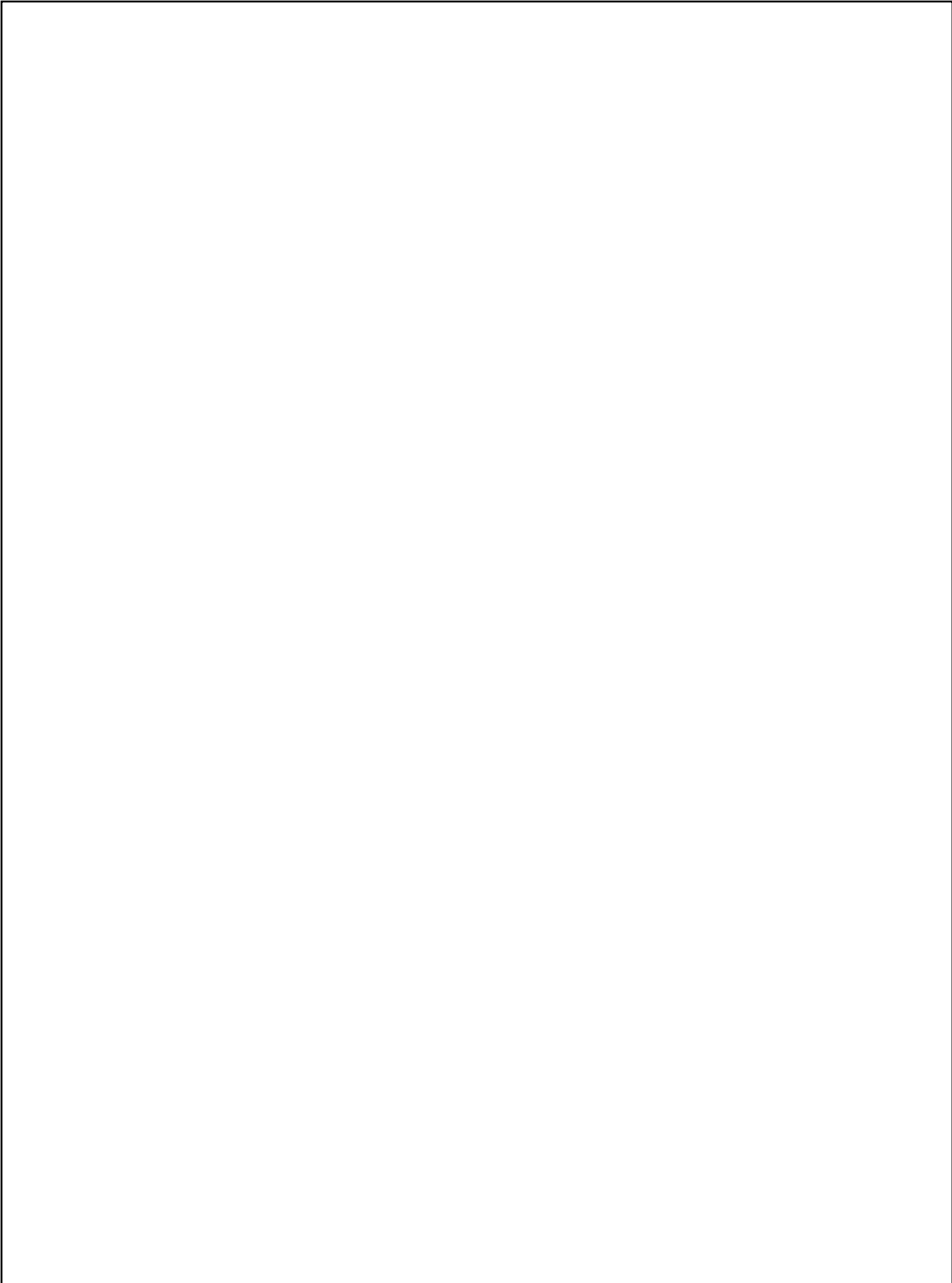

FIGURE 14. SWITCH TURN-ON AND TURN-OFF PROPAGATION DELAY TIMES WAVEFORMS



PACKAGING INFORMATION

Orderable Device	Status ⁽¹⁾	Package Type	Package Drawing	Pins	Package Qty	Eco Plan ⁽²⁾	Lead/Ball Finish	MSL Peak Temp ⁽³⁾
CD54HC4316F3A	ACTIVE	CDIP	J	16	1	TBD	A42	N / A for Pkg Type
CD74HC4316E	ACTIVE	PDIP	N	16	25	Pb-Free (RoHS)	CU NIPDAU	N / A for Pkg Type
CD74HC4316EE4	ACTIVE	PDIP	N	16	25	Pb-Free (RoHS)	CU NIPDAU	N / A for Pkg Type
CD74HC4316M	ACTIVE	SOIC	D	16	40	Green (RoHS & no Sb/Br)	CU NIPDAU	Level-1-260C-UNLIM
CD74HC4316M96	ACTIVE	SOIC	D	16	2500	Green (RoHS & no Sb/Br)	CU NIPDAU	Level-1-260C-UNLIM
CD74HC4316M96E4	ACTIVE	SOIC	D	16	2500	Green (RoHS & no Sb/Br)	CU NIPDAU	Level-1-260C-UNLIM
CD74HC4316M96G4	ACTIVE	SOIC	D	16	2500	Green (RoHS & no Sb/Br)	CU NIPDAU	Level-1-260C-UNLIM
CD74HC4316ME4	ACTIVE	SOIC	D	16	40	Green (RoHS & no Sb/Br)	CU NIPDAU	Level-1-260C-UNLIM
CD74HC4316MG4	ACTIVE	SOIC	D	16	40	Green (RoHS & no Sb/Br)	CU NIPDAU	Level-1-260C-UNLIM
CD74HC4316MT	ACTIVE	SOIC	D	16	250	Green (RoHS & no Sb/Br)	CU NIPDAU	Level-1-260C-UNLIM
CD74HC4316MTE4	ACTIVE	SOIC	D	16	250	Green (RoHS & no Sb/Br)	CU NIPDAU	Level-1-260C-UNLIM
CD74HC4316MTG4	ACTIVE	SOIC	D	16	250	Green (RoHS & no Sb/Br)	CU NIPDAU	Level-1-260C-UNLIM
CD74HC4316NSR	ACTIVE	SO	NS	16	2000	Green (RoHS & no Sb/Br)	CU NIPDAU	Level-1-260C-UNLIM
CD74HC4316NSRE4	ACTIVE	SO	NS	16	2000	Green (RoHS & no Sb/Br)	CU NIPDAU	Level-1-260C-UNLIM
CD74HC4316NSRG4	ACTIVE	SO	NS	16	2000	Green (RoHS & no Sb/Br)	CU NIPDAU	Level-1-260C-UNLIM
CD74HC4316PW	ACTIVE	TSSOP	PW	16	90	Green (RoHS & no Sb/Br)	CU NIPDAU	Level-1-260C-UNLIM
CD74HC4316PWE4	ACTIVE	TSSOP	PW	16	90	Green (RoHS & no Sb/Br)	CU NIPDAU	Level-1-260C-UNLIM
CD74HC4316PWG4	ACTIVE	TSSOP	PW	16	90	Green (RoHS & no Sb/Br)	CU NIPDAU	Level-1-260C-UNLIM
CD74HC4316PWR	ACTIVE	TSSOP	PW	16	2000	Green (RoHS & no Sb/Br)	CU NIPDAU	Level-1-260C-UNLIM
CD74HC4316PWRE4	ACTIVE	TSSOP	PW	16	2000	Green (RoHS & no Sb/Br)	CU NIPDAU	Level-1-260C-UNLIM
CD74HC4316PWRG4	ACTIVE	TSSOP	PW	16	2000	Green (RoHS & no Sb/Br)	CU NIPDAU	Level-1-260C-UNLIM
CD74HC4316PWT	ACTIVE	TSSOP	PW	16	250	Green (RoHS & no Sb/Br)	CU NIPDAU	Level-1-260C-UNLIM
CD74HC4316PWTE4	ACTIVE	TSSOP	PW	16	250	Green (RoHS & no Sb/Br)	CU NIPDAU	Level-1-260C-UNLIM
CD74HC4316PWTG4	ACTIVE	TSSOP	PW	16	250	Green (RoHS & no Sb/Br)	CU NIPDAU	Level-1-260C-UNLIM
CD74HCT4316E	ACTIVE	PDIP	N	16	25	Pb-Free (RoHS)	CU NIPDAU	N / A for Pkg Type

Orderable Device	Status ⁽¹⁾	Package Type	Package Drawing	Pins	Package Qty	Eco Plan ⁽²⁾	Lead/Ball Finish	MSL Peak Temp ⁽³⁾
CD74HCT4316EE4	ACTIVE	PDIP	N	16	25	Pb-Free (RoHS)	CU NIPDAU	N / A for Pkg Type
CD74HCT4316M	ACTIVE	SOIC	D	16	40	Green (RoHS & no Sb/Br)	CU NIPDAU	Level-1-260C-UNLIM
CD74HCT4316M96	ACTIVE	SOIC	D	16	2500	Green (RoHS & no Sb/Br)	CU NIPDAU	Level-1-260C-UNLIM
CD74HCT4316M96E4	ACTIVE	SOIC	D	16	2500	Green (RoHS & no Sb/Br)	CU NIPDAU	Level-1-260C-UNLIM
CD74HCT4316M96G4	ACTIVE	SOIC	D	16	2500	Green (RoHS & no Sb/Br)	CU NIPDAU	Level-1-260C-UNLIM
CD74HCT4316ME4	ACTIVE	SOIC	D	16	40	Green (RoHS & no Sb/Br)	CU NIPDAU	Level-1-260C-UNLIM
CD74HCT4316MG4	ACTIVE	SOIC	D	16	40	Green (RoHS & no Sb/Br)	CU NIPDAU	Level-1-260C-UNLIM
CD74HCT4316MT	ACTIVE	SOIC	D	16	250	Green (RoHS & no Sb/Br)	CU NIPDAU	Level-1-260C-UNLIM
CD74HCT4316MTE4	ACTIVE	SOIC	D	16	250	Green (RoHS & no Sb/Br)	CU NIPDAU	Level-1-260C-UNLIM
CD74HCT4316MTG4	ACTIVE	SOIC	D	16	250	Green (RoHS & no Sb/Br)	CU NIPDAU	Level-1-260C-UNLIM

⁽¹⁾ The marketing status values are defined as follows:

ACTIVE: Product device recommended for new designs.

LIFEBUY: TI has announced that the device will be discontinued, and a lifetime-buy period is in effect.

NRND: Not recommended for new designs. Device is in production to support existing customers, but TI does not recommend using this part in a new design.

PREVIEW: Device has been announced but is not in production. Samples may or may not be available.

OBSOLETE: TI has discontinued the production of the device.

⁽²⁾ Eco Plan - The planned eco-friendly classification: Pb-Free (RoHS), Pb-Free (RoHS Exempt), or Green (RoHS & no Sb/Br) - please check <http://www.ti.com/productcontent> for the latest availability information and additional product content details.

TBD: The Pb-Free/Green conversion plan has not been defined.

Pb-Free (RoHS): TI's terms "Lead-Free" or "Pb-Free" mean semiconductor products that are compatible with the current RoHS requirements for all 6 substances, including the requirement that lead not exceed 0.1% by weight in homogeneous materials. Where designed to be soldered at high temperatures, TI Pb-Free products are suitable for use in specified lead-free processes.

Pb-Free (RoHS Exempt): This component has a RoHS exemption for either 1) lead-based flip-chip solder bumps used between the die and package, or 2) lead-based die adhesive used between the die and leadframe. The component is otherwise considered Pb-Free (RoHS compatible) as defined above.

Green (RoHS & no Sb/Br): TI defines "Green" to mean Pb-Free (RoHS compatible), and free of Bromine (Br) and Antimony (Sb) based flame retardants (Br or Sb do not exceed 0.1% by weight in homogeneous material)

⁽³⁾ MSL, Peak Temp. -- The Moisture Sensitivity Level rating according to the JEDEC industry standard classifications, and peak solder temperature.

Important Information and Disclaimer: The information provided on this page represents TI's knowledge and belief as of the date that it is provided. TI bases its knowledge and belief on information provided by third parties, and makes no representation or warranty as to the accuracy of such information. Efforts are underway to better integrate information from third parties. TI has taken and continues to take reasonable steps to provide representative and accurate information but may not have conducted destructive testing or chemical analysis on incoming materials and chemicals. TI and TI suppliers consider certain information to be proprietary, and thus CAS numbers and other limited information may not be available for release.

In no event shall TI's liability arising out of such information exceed the total purchase price of the TI part(s) at issue in this document sold by TI to Customer on an annual basis.

TAPE AND REEL INFORMATION
REEL DIMENSIONS

TAPE DIMENSIONS

A0	Dimension designed to accommodate the component width
B0	Dimension designed to accommodate the component length
K0	Dimension designed to accommodate the component thickness
W	Overall width of the carrier tape
P1	Pitch between successive cavity centers

TAPE AND REEL INFORMATION

*All dimensions are nominal

Device	Package Type	Package Drawing	Pins	SPQ	Reel Diameter (mm)	Reel Width W1 (mm)	A0 (mm)	B0 (mm)	K0 (mm)	P1 (mm)	W (mm)	Pin1 Quadrant
CD74HC4316M96	SOIC	D	16	2500	330.0	16.4	6.5	10.3	2.1	8.0	16.0	Q1
CD74HC4316NSR	SO	NS	16	2000	330.0	16.4	8.2	10.5	2.5	12.0	16.0	Q1
CD74HC4316PWR	TSSOP	PW	16	2000	330.0	12.4	6.9	5.6	1.6	8.0	12.0	Q1
CD74HC4316PWT	TSSOP	PW	16	250	330.0	12.4	6.9	5.6	1.6	8.0	12.0	Q1
CD74HCT4316M96	SOIC	D	16	2500	330.0	16.4	6.5	10.3	2.1	8.0	16.0	Q1

TAPE AND REEL BOX DIMENSIONS

*All dimensions are nominal

Device	Package Type	Package Drawing	Pins	SPQ	Length (mm)	Width (mm)	Height (mm)
CD74HC4316M96	SOIC	D	16	2500	333.2	345.9	28.6
CD74HC4316NSR	SO	NS	16	2000	367.0	367.0	38.0
CD74HC4316PWR	TSSOP	PW	16	2000	367.0	367.0	35.0
CD74HC4316PWT	TSSOP	PW	16	250	367.0	367.0	35.0
CD74HCT4316M96	SOIC	D	16	2500	333.2	345.9	28.6

J (R-GDIP-T**)

14 LEADS SHOWN

CERAMIC DUAL IN-LINE PACKAGE



DIM \ PINS **	14	16	18	20
A	0.300 (7,62) BSC	0.300 (7,62) BSC	0.300 (7,62) BSC	0.300 (7,62) BSC
B MAX	0.785 (19,94)	.840 (21,34)	0.960 (24,38)	1.060 (26,92)
B MIN	—	—	—	—
C MAX	0.300 (7,62)	0.300 (7,62)	0.310 (7,87)	0.300 (7,62)
C MIN	0.245 (6,22)	0.245 (6,22)	0.220 (5,59)	0.245 (6,22)



4040083/F 03/03

- NOTES:
- A. All linear dimensions are in inches (millimeters).
 - B. This drawing is subject to change without notice.
 - C. This package is hermetically sealed with a ceramic lid using glass frit.
 - D. Index point is provided on cap for terminal identification only on press ceramic glass frit seal only.
 - E. Falls within MIL STD 1835 GDIP1-T14, GDIP1-T16, GDIP1-T18 and GDIP1-T20.

N (R-PDIP-T**)

PLASTIC DUAL-IN-LINE PACKAGE

16 PINS SHOWN



- NOTES:
- A. All linear dimensions are in inches (millimeters).
 - B. This drawing is subject to change without notice.
 - Falls within JEDEC MS-001, except 18 and 20 pin minimum body length (Dim A).
 - The 20 pin end lead shoulder width is a vendor option, either half or full width.

D (R-PDSO-G16)

PLASTIC SMALL OUTLINE





- NOTES:
- A. All linear dimensions are in inches (millimeters).
 - B. This drawing is subject to change without notice.
 - C. Body length does not include mold flash, protrusions, or gate burrs. Mold flash, protrusions, or gate burrs shall not exceed 0.006 (0,15) each side.
 - D. Body width does not include interlead flash. Interlead flash shall not exceed 0.017 (0,43) each side.
 - E. Reference JEDEC MS-012 variation AC.

PW (R-PDSO-G16)

PLASTIC SMALL OUTLINE



- NOTES:
- A. All linear dimensions are in millimeters. Dimensioning and tolerancing per ASME Y14.5M-1994.
 - B. This drawing is subject to change without notice.
 -  C. Body length does not include mold flash, protrusions, or gate burrs. Mold flash, protrusions, or gate burrs shall not exceed 0,15 each side.
 -  D. Body width does not include interlead flash. Interlead flash shall not exceed 0,25 each side.
 - E. Falls within JEDEC MO-153

PW (R-PDSO-G16)

PLASTIC SMALL OUTLINE

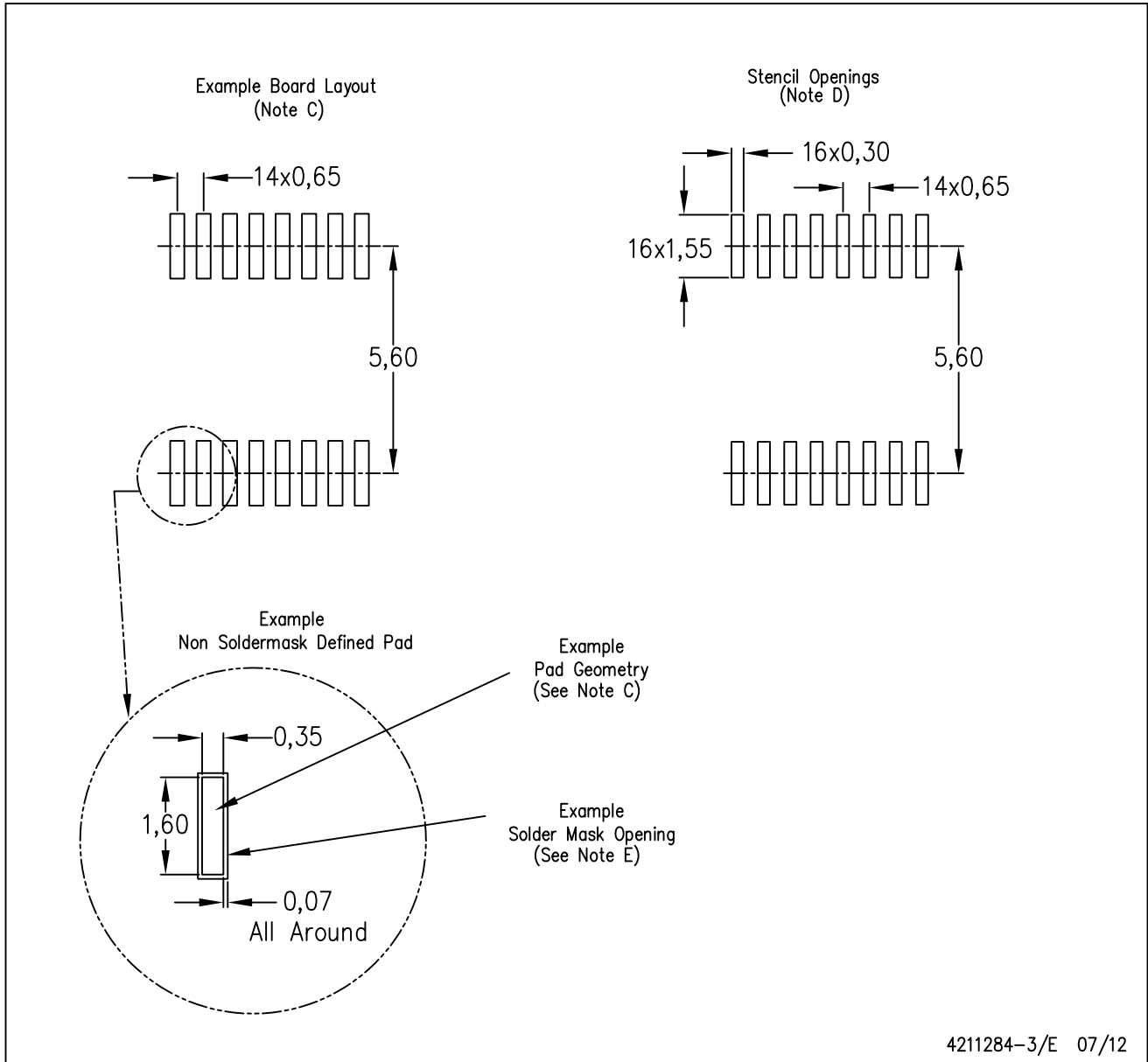

- NOTES:
- All linear dimensions are in millimeters.
 - This drawing is subject to change without notice.
 - Publication IPC-7351 is recommended for alternate designs.
 - Laser cutting apertures with trapezoidal walls and also rounding corners will offer better paste release. Customers should contact their board assembly site for stencil design recommendations. Refer to IPC-7525 for other stencil recommendations.
 - Customers should contact their board fabrication site for solder mask tolerances between and around signal pads.

MECHANICAL DATA

NS (R-PDSO-G**)

PLASTIC SMALL-OUTLINE PACKAGE

14-PINS SHOWN



- NOTES:
- A. All linear dimensions are in millimeters.
 - B. This drawing is subject to change without notice.
 - C. Body dimensions do not include mold flash or protrusion, not to exceed 0,15.

IMPORTANT NOTICE

Texas Instruments Incorporated and its subsidiaries (TI) reserve the right to make corrections, enhancements, improvements and other changes to its semiconductor products and services per JESD46C and to discontinue any product or service per JESD48B. Buyers should obtain the latest relevant information before placing orders and should verify that such information is current and complete. All semiconductor products (also referred to herein as "components") are sold subject to TI's terms and conditions of sale supplied at the time of order acknowledgment.

TI warrants performance of its components to the specifications applicable at the time of sale, in accordance with the warranty in TI's terms and conditions of sale of semiconductor products. Testing and other quality control techniques are used to the extent TI deems necessary to support this warranty. Except where mandated by applicable law, testing of all parameters of each component is not necessarily performed.

TI assumes no liability for applications assistance or the design of Buyers' products. Buyers are responsible for their products and applications using TI components. To minimize the risks associated with Buyers' products and applications, Buyers should provide adequate design and operating safeguards.

TI does not warrant or represent that any license, either express or implied, is granted under any patent right, copyright, mask work right, or other intellectual property right relating to any combination, machine, or process in which TI components or services are used. Information published by TI regarding third-party products or services does not constitute a license to use such products or services or a warranty or endorsement thereof. Use of such information may require a license from a third party under the patents or other intellectual property of the third party, or a license from TI under the patents or other intellectual property of TI.

Reproduction of significant portions of TI information in TI data books or data sheets is permissible only if reproduction is without alteration and is accompanied by all associated warranties, conditions, limitations, and notices. TI is not responsible or liable for such altered documentation. Information of third parties may be subject to additional restrictions.

Resale of TI components or services with statements different from or beyond the parameters stated by TI for that component or service voids all express and any implied warranties for the associated TI component or service and is an unfair and deceptive business practice. TI is not responsible or liable for any such statements.

Buyer acknowledges and agrees that it is solely responsible for compliance with all legal, regulatory and safety-related requirements concerning its products, and any use of TI components in its applications, notwithstanding any applications-related information or support that may be provided by TI. Buyer represents and agrees that it has all the necessary expertise to create and implement safeguards which anticipate dangerous consequences of failures, monitor failures and their consequences, lessen the likelihood of failures that might cause harm and take appropriate remedial actions. Buyer will fully indemnify TI and its representatives against any damages arising out of the use of any TI components in safety-critical applications.

In some cases, TI components may be promoted specifically to facilitate safety-related applications. With such components, TI's goal is to help enable customers to design and create their own end-product solutions that meet applicable functional safety standards and requirements. Nonetheless, such components are subject to these terms.

No TI components are authorized for use in FDA Class III (or similar life-critical medical equipment) unless authorized officers of the parties have executed a special agreement specifically governing such use.

Only those TI components which TI has specifically designated as military grade or "enhanced plastic" are designed and intended for use in military/aerospace applications or environments. Buyer acknowledges and agrees that any military or aerospace use of TI components which have **not** been so designated is solely at the Buyer's risk, and that Buyer is solely responsible for compliance with all legal and regulatory requirements in connection with such use.

TI has specifically designated certain components which meet ISO/TS16949 requirements, mainly for automotive use. Components which have not been so designated are neither designed nor intended for automotive use; and TI will not be responsible for any failure of such components to meet such requirements.

Products

Audio	www.ti.com/audio
Amplifiers	amplifier.ti.com
Data Converters	dataconverter.ti.com
DLP® Products	www.dlp.com
DSP	dsp.ti.com
Clocks and Timers	www.ti.com/clocks
Interface	interface.ti.com
Logic	logic.ti.com
Power Mgmt	power.ti.com
Microcontrollers	microcontroller.ti.com
RFID	www.ti-rfid.com
OMAP Mobile Processors	www.ti.com/omap
Wireless Connectivity	www.ti.com/wirelessconnectivity

Applications

Automotive and Transportation	www.ti.com/automotive
Communications and Telecom	www.ti.com/communications
Computers and Peripherals	www.ti.com/computers
Consumer Electronics	www.ti.com/consumer-apps
Energy and Lighting	www.ti.com/energy
Industrial	www.ti.com/industrial
Medical	www.ti.com/medical
Security	www.ti.com/security
Space, Avionics and Defense	www.ti.com/space-avionics-defense
Video and Imaging	www.ti.com/video

TI E2E Community e2e.ti.com