

CD4011A, CD4012A, CD4023A Types

CMOS NAND Gates

Quad 2 Input – CD4011A
Dual 4 Input – CD4012A
Triple 3 Input – CD4023A

The TI-CD4011A, CD4012A, and CD-4023A NAND gates provide the system designer with direct implementation of the NAND function and supplement the existing family of CMOS gates.

These types are supplied in 14-lead hermetic dual-in-line ceramic packages (D and F suffixes), 14-lead dual-in-line plastic packages (E suffix), 14-lead ceramic flat packages (K suffix), and in chip form (H suffix).

Features:

- Quiescent current specified to 15 μ A
- Maximum input leakage of 1 μ A at 15 V (full package-temperature range)
- 1-V noise margin (full package-temperature range)

RECOMMENDED OPERATING CONDITIONS

For maximum reliability, nominal operating conditions should be selected so that operation is always within the following ranges:

Characteristic	Min.	Max.	Units
Supply Voltage Range (over full package temperature range)	3	12	V

MAXIMUM RATINGS, Absolute-Maximum Values:

STORAGE-TEMPERATURE RANGE (T_{stg}) -65 to +150°C
 OPERATING-TEMPERATURE RANGE (T_A):
 PACKAGE TYPES D, F, K, H -55 to +125°C
 PACKAGE TYPE E -40 to +85°C
 DC SUPPLY-VOLTAGE RANGE, (V_{DD})
 (Voltages referenced to V_{SS} Terminal) -0.5 to +15 V
 POWER DISSIPATION PER PACKAGE (P_D):
 FOR $T_A = -40$ to +60°C (PACKAGE TYPE E) 500 mW
 FOR $T_A = +60$ to +85°C (PACKAGE TYPE E) Derate Linearly at 12 mW/°C to 200 mW
 FOR $T_A = -55$ to +100°C (PACKAGE TYPES D, F, K) 500 mW
 FOR $T_A = +100$ to +125°C (PACKAGE TYPES D, F, K) Derate Linearly at 12 mW/°C to 200 mW
 DEVICE DISSIPATION PER OUTPUT TRANSISTOR
 FOR $T_A =$ FULL PACKAGE-TEMPERATURE RANGE (ALL PACKAGE TYPES) 100 mW
 INPUT VOLTAGE RANGE, ALL INPUTS -0.5 to $V_{DD} + 0.5$ V
 LEAD TEMPERATURE (DURING SOLDERING):
 At distance 1/16 \pm 1/32 inch (1.59 \pm 0.79 mm) from case for 10 s max. +265°C

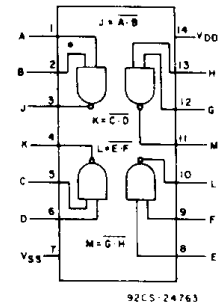

CD4011A

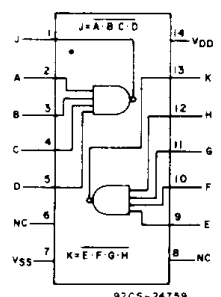

CD4012A

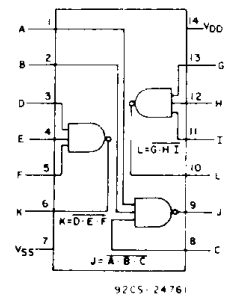

CD4023AH

Fig. 1 – Functional diagrams.

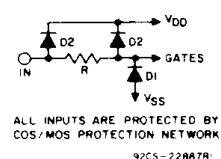

92CS-22887R

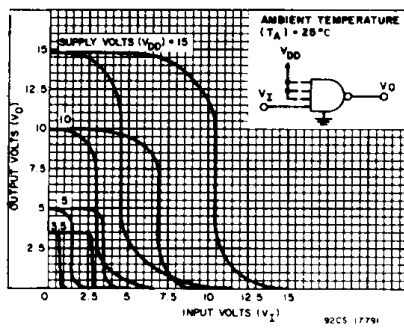

Fig. 2 – Minimum & maximum voltage transfer characteristics.

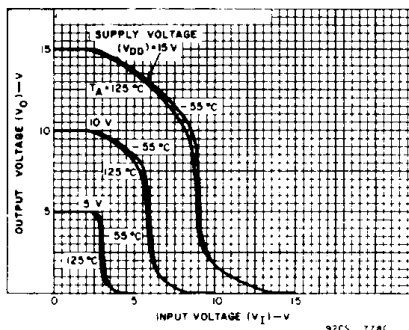

Fig. 3 – Typical voltage transfer characteristics as a function of temperature.

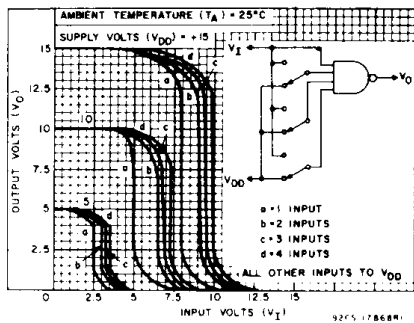

Fig. 4 – Typical multiple input switching transfer characteristics for CD4012A.

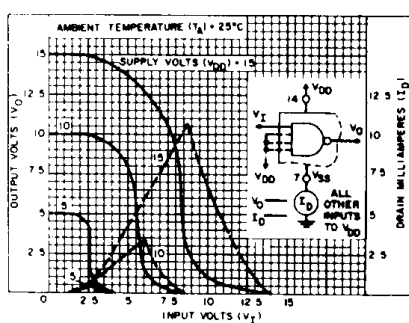

Fig. 5 – Typical current & voltage transfer characteristics.

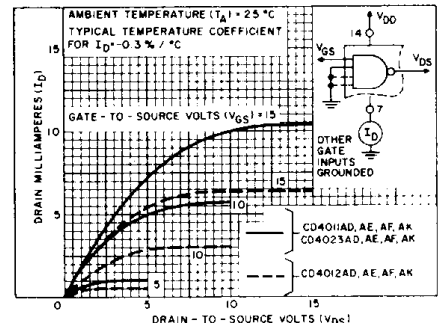

Fig. 6 – Typical n-channel drain characteristics.

CD4011A, CD4012A, CD4023A Types

STATIC ELECTRICAL CHARACTERISTICS

Characteristic	Conditions			Limits at Indicated Temperatures (°C)								Units
	V _O (V)	V _{IN} (V)	V _{DD} (V)	D, F, K, H Packages				E Package				
				-55	+25		+125	-40	+25		+85	
				Typ.	Limit			Typ.	Limit			
Quiescent Device Current, I _L Max.	-	-	5	0.05	0.001	0.05	3	0.5	0.005	0.5	15	μA
	-	-	10	0.1	0.001	0.1	6	5	0.005	5	30	
	-	-	15	2	0.02	2	40	50	0.5	50	500	
Output Voltage: Low-Level V _{OL}	-	0, 5	5	0 Typ.; 0.05 Max.								V
High Level, V _{OH}	-	0, 10	10	4.95 Min.; 5 Typ.								
	-	0, 10	10	9.95 Min.; 10 Typ.								
Noise Immunity: Inputs Low, V _{NL}	3.6	-	5	1.5 Min.; 2.25 Typ.								V
	7.2	-	10	3 Min.; 4.5 Typ.								
Inputs High, V _{NH}	1.4	-	5	1.5 Min.; 2.25 Typ.;								
	2.8	-	10	3 Min.; 4.5 Typ.								
Noise Margin: Inputs Low, V _{NML}	4.5	-	5	1 Min.								V
	9	-	10	1 Min.								
Inputs High, V _{NMH}	0.5	-	5	1 Min.								
	1	-	10	1 Min.								
Output Drive Current: N-Channel (Sink) I _{DN} Min.												mA
CD4011A	0.5	-	5	0.31	0.5	0.25	0.175	0.145	0.5	0.12	0.095	
CD4023A	0.5	-	10	0.62	0.6	0.5	0.35	0.3	0.6	0.25	0.2	
CD4012A	0.5	-	5	0.15	0.25	0.12	0.085	0.072	0.25	0.06	0.05	
	0.5	-	10	0.31	0.6	0.25	0.175	0.155	0.6	0.13	0.105	
P-Channel (Source) I _{DP} Min.												mA
All Types	4.5	-	5	-0.31	-0.5	-0.25	-0.175	-0.145	-0.5	-0.12	-0.095	
	9.5	-	10	-0.75	-1.2	-0.6	-0.4	-0.35	-1.2	-0.3	-0.24	
Input Leakage Current, I _L , I _{IH}	Any Input		15	±10 ⁻⁵ Typ.; ±1 Max.								μA

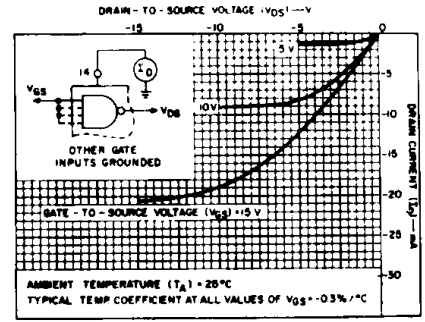

Fig. 7 - Typical p-channel drain characteristics.

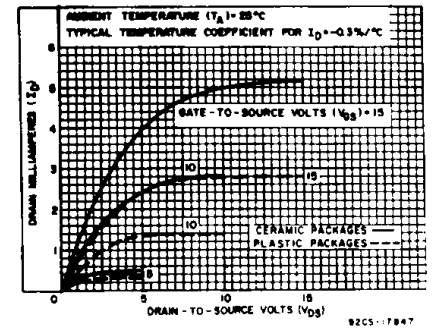

Fig. 8 - Minimum n-channel drain characteristics - CD4011A & CD4023A.

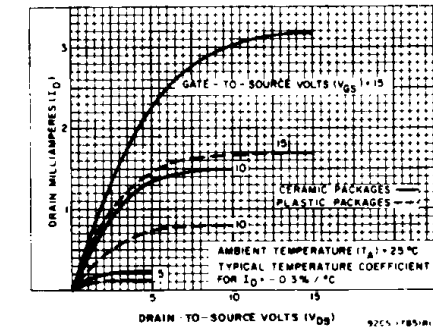

Fig. 9 - Minimum n-channel drain characteristics.

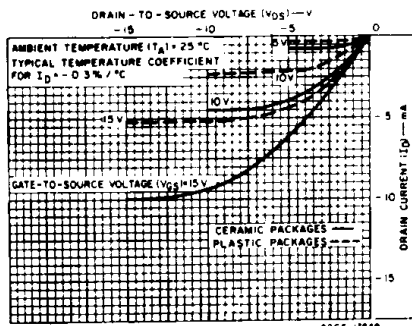

Fig. 10 - Minimum p-channel drain characteristics.

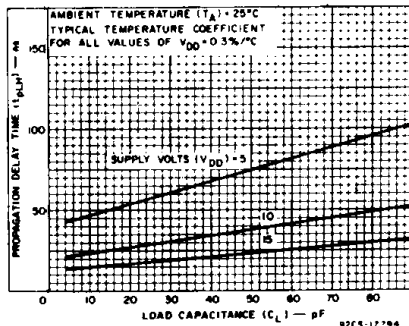

Fig. 11 - Typical low-to-high level propagation delay time vs. C_L.

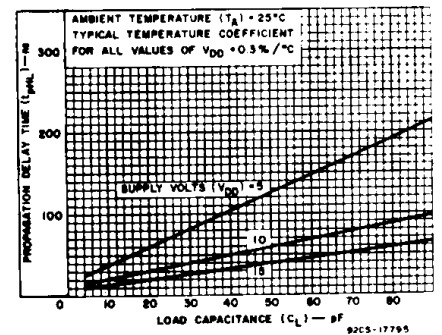

Fig. 12 - Typical high-to-low level propagation delay time vs. C_L - CD4011A, & CD4023A.

CD4011A, CD4012A, CD4023A Types

DYNAMIC ELECTRICAL CHARACTERISTICS at $T_A = 25^\circ\text{C}$, $C_L = 15\text{ pF}$, Input $t_r, t_f = 20\text{ ns}$, $R_L = 200\text{ k}\Omega$

CHARACTERISTICS	TEST CONDITIONS	LIMITS				UNITS	
		D, F, K, H Packages		E Package			
		V _{DD} (V)	Typ.	Max.	Typ.		Max.
Propagation Delay Time: Low-to-High Level, t_{PLH}		5	50	75	50	100	ns
		10	25	40	25	50	
High-to-Low Level, t_{PHL} CD4011A and CD4023A		5	50	75	50	100	ns
		10	25	40	25	50	
CD4012A		5	100	150	100	200	ns
		10	50	75	50	100	
Transition Time: Low-to-High Level, t_{TLH}		5	75	100	75	125	ns
		10	40	60	40	75	
High-to-Low Level, t_{THL} CD4011A and CD4023A		5	75	125	75	150	ns
		10	50	75	50	100	
CD4012A		5	250	375	250	500	ns
		10	125	200	125	250	
Input Capacitance, C_i	Any Input	5	—	5	—	—	pF

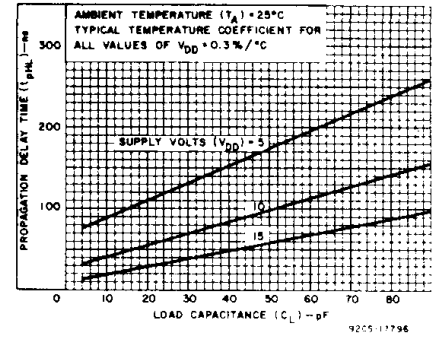

Fig. 13 — Typical high-to-low level propagation delay time vs. C_L — CD4012A.

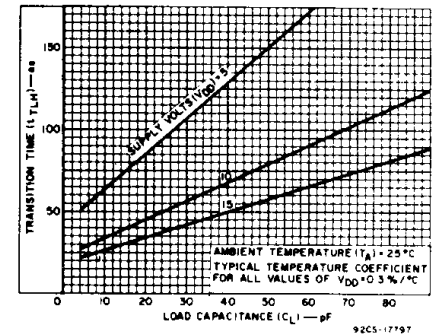

Fig. 14 — Typical low-to-high transition time vs. C_L .

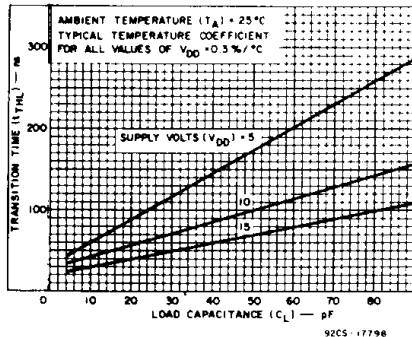

Fig. 15 — Typical high-to-low level transition time vs. C_L — CD4011A & CD4023A.

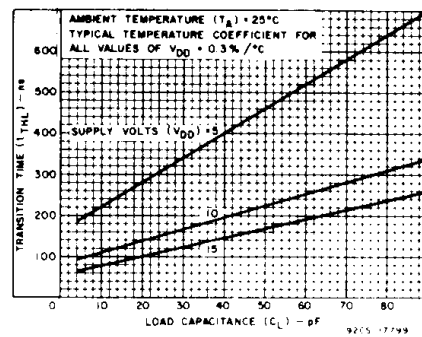

Fig. 16 — Typical high-to-low level transition time vs. C_L — CD4012A.

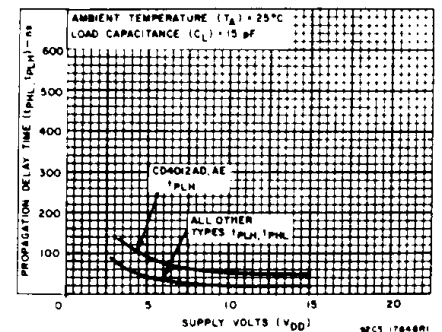

Fig. 17 — Minimum propagation delay time vs. V_{DD} .

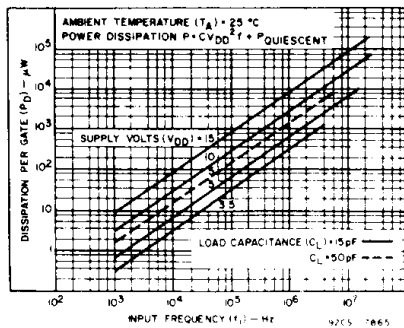

Fig. 18 — Typical dissipation characteristics.

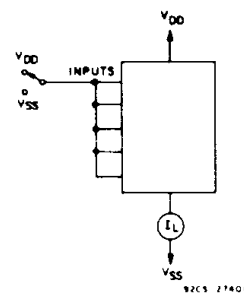

Fig. 19 — Quiescent device current test circuit.

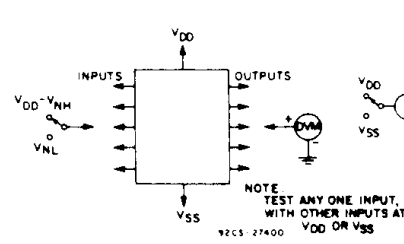

Fig. 20 — Noise immunity test circuit.

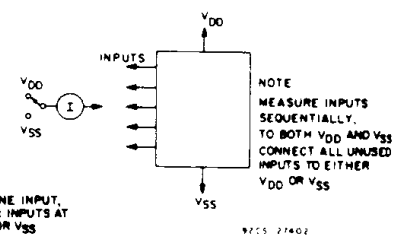

Fig. 21 — Input leakage current test circuit.

PACKAGING INFORMATION

Orderable Device	Status ⁽¹⁾	Package Type	Package Drawing	Pins	Package Qty	Eco Plan ⁽²⁾	Lead/Ball Finish	MSL Peak Temp ⁽³⁾
CD4011AD3	ACTIVE	CDIP SB	JD	14	1	TBD	POST-PLATE	N / A for Pkg Type
CD4023AFB	OBSOLETE	CDIP	J	14		TBD	Call TI	Call TI
JM38510/05001BCA	ACTIVE	CDIP	J	14	1	TBD	A42	N / A for Pkg Type
JM38510/05003BCA	OBSOLETE	CDIP	J	14		TBD	Call TI	Call TI
M/05003BCA	OBSOLETE	CDIP	J	14		TBD	Call TI	Call TI

⁽¹⁾ The marketing status values are defined as follows:

ACTIVE: Product device recommended for new designs.

LIFEBUY: TI has announced that the device will be discontinued, and a lifetime-buy period is in effect.

NRND: Not recommended for new designs. Device is in production to support existing customers, but TI does not recommend using this part in a new design.

PREVIEW: Device has been announced but is not in production. Samples may or may not be available.

OBSOLETE: TI has discontinued the production of the device.

⁽²⁾ Eco Plan - The planned eco-friendly classification: Pb-Free (RoHS), Pb-Free (RoHS Exempt), or Green (RoHS & no Sb/Br) - please check <http://www.ti.com/productcontent> for the latest availability information and additional product content details.

TBD: The Pb-Free/Green conversion plan has not been defined.

Pb-Free (RoHS): TI's terms "Lead-Free" or "Pb-Free" mean semiconductor products that are compatible with the current RoHS requirements for all 6 substances, including the requirement that lead not exceed 0.1% by weight in homogeneous materials. Where designed to be soldered at high temperatures, TI Pb-Free products are suitable for use in specified lead-free processes.

Pb-Free (RoHS Exempt): This component has a RoHS exemption for either 1) lead-based flip-chip solder bumps used between the die and package, or 2) lead-based die adhesive used between the die and leadframe. The component is otherwise considered Pb-Free (RoHS compatible) as defined above.

Green (RoHS & no Sb/Br): TI defines "Green" to mean Pb-Free (RoHS compatible), and free of Bromine (Br) and Antimony (Sb) based flame retardants (Br or Sb do not exceed 0.1% by weight in homogeneous material)

⁽³⁾ MSL, Peak Temp. -- The Moisture Sensitivity Level rating according to the JEDEC industry standard classifications, and peak solder temperature.

Important Information and Disclaimer: The information provided on this page represents TI's knowledge and belief as of the date that it is provided. TI bases its knowledge and belief on information provided by third parties, and makes no representation or warranty as to the accuracy of such information. Efforts are underway to better integrate information from third parties. TI has taken and continues to take reasonable steps to provide representative and accurate information but may not have conducted destructive testing or chemical analysis on incoming materials and chemicals. TI and TI suppliers consider certain information to be proprietary, and thus CAS numbers and other limited information may not be available for release.

In no event shall TI's liability arising out of such information exceed the total purchase price of the TI part(s) at issue in this document sold by TI to Customer on an annual basis.

J (R-GDIP-T**)

14 LEADS SHOWN

CERAMIC DUAL IN-LINE PACKAGE



DIM \ PINS **	14	16	18	20
A	0.300 (7,62) BSC	0.300 (7,62) BSC	0.300 (7,62) BSC	0.300 (7,62) BSC
B MAX	0.785 (19,94)	.840 (21,34)	0.960 (24,38)	1.060 (26,92)
B MIN	—	—	—	—
C MAX	0.300 (7,62)	0.300 (7,62)	0.310 (7,87)	0.300 (7,62)
C MIN	0.245 (6,22)	0.245 (6,22)	0.220 (5,59)	0.245 (6,22)



4040083/F 03/03

- NOTES:
- All linear dimensions are in inches (millimeters).
 - This drawing is subject to change without notice.
 - This package is hermetically sealed with a ceramic lid using glass frit.
 - Index point is provided on cap for terminal identification only on press ceramic glass frit seal only.
 - Falls within MIL STD 1835 GDIP1-T14, GDIP1-T16, GDIP1-T18 and GDIP1-T20.

JD (R-CDIP-T14)

CERAMIC SIDE-BRAZE DUAL-IN-LINE

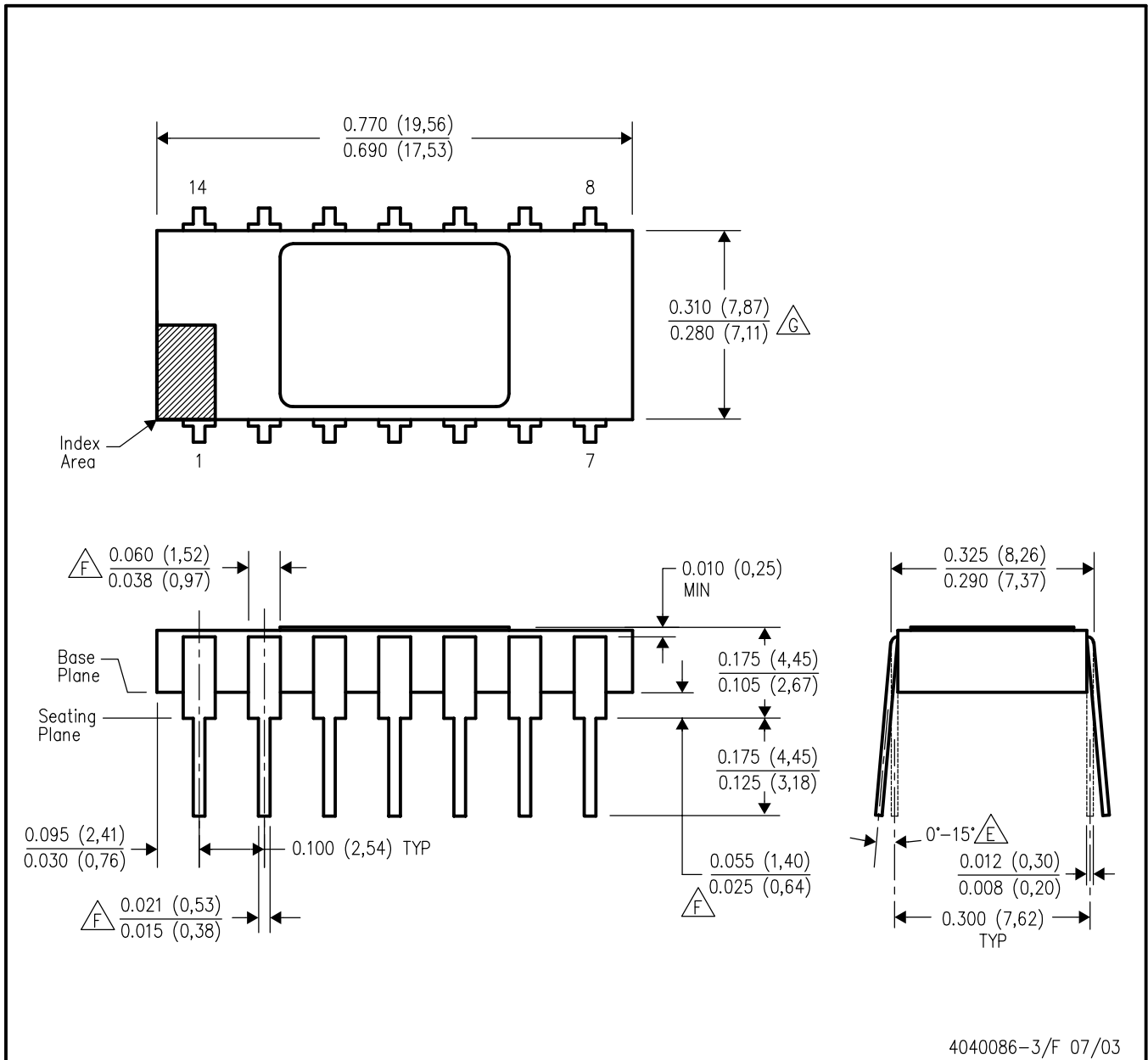

- NOTES:
- A. All linear dimensions are in inches (millimeters).
 - B. This drawing is subject to change without notice.
 - C. Controlling dimension: inch.
 - D. Leads within 0.005 (0,13) radius of true position (TP) at gage plane with maximum material condition and unit installed.
 - E. Angle applies to spread leads prior to installation.
 - F. Outlines on which the seating plane is coincident with the plane (standoff = 0), terminals lead standoffs are not required, and lead shoulder may equal lead width along any part of the lead above the seating/base plane.
 - G. Body width does not include particles of packing materials.
 - H. A visual index feature must be located within the cross-hatched area.

IMPORTANT NOTICE

Texas Instruments Incorporated and its subsidiaries (TI) reserve the right to make corrections, modifications, enhancements, improvements, and other changes to its products and services at any time and to discontinue any product or service without notice. Customers should obtain the latest relevant information before placing orders and should verify that such information is current and complete. All products are sold subject to TI's terms and conditions of sale supplied at the time of order acknowledgment.

TI warrants performance of its hardware products to the specifications applicable at the time of sale in accordance with TI's standard warranty. Testing and other quality control techniques are used to the extent TI deems necessary to support this warranty. Except where mandated by government requirements, testing of all parameters of each product is not necessarily performed.

TI assumes no liability for applications assistance or customer product design. Customers are responsible for their products and applications using TI components. To minimize the risks associated with customer products and applications, customers should provide adequate design and operating safeguards.

TI does not warrant or represent that any license, either express or implied, is granted under any TI patent right, copyright, mask work right, or other TI intellectual property right relating to any combination, machine, or process in which TI products or services are used. Information published by TI regarding third-party products or services does not constitute a license from TI to use such products or services or a warranty or endorsement thereof. Use of such information may require a license from a third party under the patents or other intellectual property of the third party, or a license from TI under the patents or other intellectual property of TI.

Reproduction of TI information in TI data books or data sheets is permissible only if reproduction is without alteration and is accompanied by all associated warranties, conditions, limitations, and notices. Reproduction of this information with alteration is an unfair and deceptive business practice. TI is not responsible or liable for such altered documentation. Information of third parties may be subject to additional restrictions.

Resale of TI products or services with statements different from or beyond the parameters stated by TI for that product or service voids all express and any implied warranties for the associated TI product or service and is an unfair and deceptive business practice. TI is not responsible or liable for any such statements.

TI products are not authorized for use in safety-critical applications (such as life support) where a failure of the TI product would reasonably be expected to cause severe personal injury or death, unless officers of the parties have executed an agreement specifically governing such use. Buyers represent that they have all necessary expertise in the safety and regulatory ramifications of their applications, and acknowledge and agree that they are solely responsible for all legal, regulatory and safety-related requirements concerning their products and any use of TI products in such safety-critical applications, notwithstanding any applications-related information or support that may be provided by TI. Further, Buyers must fully indemnify TI and its representatives against any damages arising out of the use of TI products in such safety-critical applications.

TI products are neither designed nor intended for use in military/aerospace applications or environments unless the TI products are specifically designated by TI as military-grade or "enhanced plastic." Only products designated by TI as military-grade meet military specifications. Buyers acknowledge and agree that any such use of TI products which TI has not designated as military-grade is solely at the Buyer's risk, and that they are solely responsible for compliance with all legal and regulatory requirements in connection with such use.

TI products are neither designed nor intended for use in automotive applications or environments unless the specific TI products are designated by TI as compliant with ISO/TS 16949 requirements. Buyers acknowledge and agree that, if they use any non-designated products in automotive applications, TI will not be responsible for any failure to meet such requirements.

Following are URLs where you can obtain information on other Texas Instruments products and application solutions:

Products

Amplifiers	amplifier.ti.com
Data Converters	dataconverter.ti.com
DLP® Products	www.dlp.com
DSP	dsp.ti.com
Clocks and Timers	www.ti.com/clocks
Interface	interface.ti.com
Logic	logic.ti.com
Power Mgmt	power.ti.com
Microcontrollers	microcontroller.ti.com
RFID	www.ti-rfid.com
RF/IF and ZigBee® Solutions	www.ti.com/lprf

Applications

Audio	www.ti.com/audio
Automotive	www.ti.com/automotive
Broadband	www.ti.com/broadband
Digital Control	www.ti.com/digitalcontrol
Medical	www.ti.com/medical
Military	www.ti.com/military
Optical Networking	www.ti.com/opticalnetwork
Security	www.ti.com/security
Telephony	www.ti.com/telephony
Video & Imaging	www.ti.com/video
Wireless	www.ti.com/wireless

Mailing Address: Texas Instruments, Post Office Box 655303, Dallas, Texas 75265
Copyright © 2009, Texas Instruments Incorporated