

SN54HC02, SN74HC02 QUADRUPLE 2-INPUT POSITIVE-NOR GATES

SCLS076E – DECEMBER 1982 – REVISED AUGUST 2003

- Wide Operating Voltage Range of 2 V to 6 V
- Outputs Can Drive Up To 10 LSTTL Loads
- Low Power Consumption, 20- μ A Max I_{CC}
- Typical $t_{pd} = 8$ ns
- ± 4 -mA Output Drive at 5 V
- Low Input Current of 1 μ A Max

SN54HC02 . . . J OR W PACKAGE
SN74HC02 . . . D, DB, N, NS, OR PW PACKAGE
(TOP VIEW)

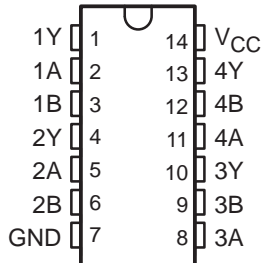

SN54HC02 . . . FK PACKAGE
(TOP VIEW)

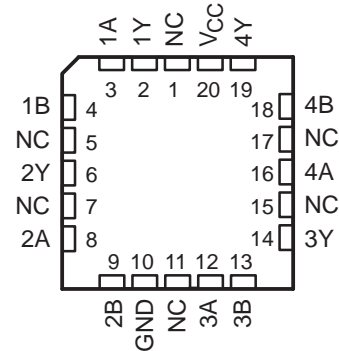

NC – No internal connection

description/ordering information

The 'HC02 devices contain four independent 2-input NOR gates. They perform the Boolean function $Y = A + B$ or $Y = \overline{A} \cdot \overline{B}$ in positive logic.

ORDERING INFORMATION

| T _A | PACKAGE† | | ORDERABLE PART NUMBER | TOP-SIDE MARKING |
|----------------|------------|--------------|-----------------------|------------------|
| -40°C to 85°C | PDIP – N | Tube of 25 | SN74HC02N | SN74HC02N |
| | SOIC – D | Tube of 50 | SN74HC02D | HC02 |
| | | Reel of 2500 | SN74HC02DR | |
| | | Reel of 250 | SN74HC02DT | |
| | SOP – NS | Reel of 2000 | SN74HC02NSR | HC02 |
| | SSOP – DB | Reel of 2000 | SN74HC02DBR | HC02 |
| | TSSOP – PW | Tube of 90 | SN74HC02PW | HC02 |
| Reel of 2000 | | SN74HC02PWR | | |
| Reel of 250 | | SN74HC02PWT | | |
| -55°C to 125°C | CDIP – J | Tube of 25 | SNJ54HC02J | SNJ54HC02J |
| | CFP – W | Tube of 150 | SNJ54HC02W | SNJ54HC02W |
| | LCCC – FK | Tube of 55 | SNJ54HC02FK | SNJ54HC02FK |

† Package drawings, standard packing quantities, thermal data, symbolization, and PCB design guidelines are available at www.ti.com/sc/package.



Please be aware that an important notice concerning availability, standard warranty, and use in critical applications of Texas Instruments semiconductor products and disclaimers thereto appears at the end of this data sheet.

PRODUCTION DATA information is current as of publication date. Products conform to specifications per the terms of Texas Instruments standard warranty. Production processing does not necessarily include testing of all parameters.

 **TEXAS
INSTRUMENTS**

POST OFFICE BOX 655303 • DALLAS, TEXAS 75265

Copyright © 2003, Texas Instruments Incorporated
On products compliant to MIL-PRF-38535, all parameters are tested unless otherwise noted. On all other products, production processing does not necessarily include testing of all parameters.

SN54HC02, SN74HC02 QUADRUPLE 2-INPUT POSITIVE-NOR GATES

SCLS076E – DECEMBER 1982 – REVISED AUGUST 2003

FUNCTION TABLE
(each gate)

| INPUTS | | OUTPUT |
|--------|---|--------|
| A | B | Y |
| H | X | L |
| X | H | L |
| L | L | H |

logic diagram (positive logic)



absolute maximum ratings over operating free-air temperature range (unless otherwise noted)†

| | |
|---|----------------|
| Supply voltage range, V_{CC} | -0.5 V to 7 V |
| Input clamp current, I_{IK} ($V_I < 0$ or $V_I > V_{CC}$) (see Note 1) | ± 20 mA |
| Output clamp current, I_{OK} ($V_O < 0$ or $V_O > V_{CC}$) (see Note 1) | ± 20 mA |
| Continuous output current, I_O ($V_O = 0$ to V_{CC}) | ± 25 mA |
| Continuous current through V_{CC} or GND | ± 50 mA |
| Package thermal impedance, θ_{JA} (see Note 2): D package | 86°C/W |
| DB package | 96°C/W |
| N package | 80°C/W |
| NS package | 76°C/W |
| PW package | 113°C/W |
| Storage temperature range, T_{stg} | -65°C to 150°C |

† Stresses beyond those listed under “absolute maximum ratings” may cause permanent damage to the device. These are stress ratings only, and functional operation of the device at these or any other conditions beyond those indicated under “recommended operating conditions” is not implied. Exposure to absolute-maximum-rated conditions for extended periods may affect device reliability.

NOTES: 1. The input and output voltage ratings may be exceeded if the input and output current ratings are observed.
2. The package thermal impedance is calculated in accordance with JESD 51-7.

recommended operating conditions (see Note 3)

| | | SN54HC02 | | | SN74HC02 | | | UNIT |
|---------------------|---------------------------------|------------------|-----|----------|----------|----------|-----|------|
| | | MIN | NOM | MAX | MIN | NOM | MAX | |
| V_{CC} | Supply voltage | 2 | 5 | 6 | 2 | 5 | 6 | V |
| V_{IH} | High-level input voltage | $V_{CC} = 2$ V | | 1.5 | 1.5 | | V | |
| | | $V_{CC} = 4.5$ V | | 3.15 | 3.15 | | | |
| | | $V_{CC} = 6$ V | | 4.2 | 4.2 | | | |
| V_{IL} | Low-level input voltage | $V_{CC} = 2$ V | | | 0.5 | 0.5 | V | |
| | | $V_{CC} = 4.5$ V | | | 1.35 | 1.35 | | |
| | | $V_{CC} = 6$ V | | | 1.8 | 1.8 | | |
| V_I | Input voltage | 0 | | V_{CC} | 0 | V_{CC} | V | |
| V_O | Output voltage | 0 | | V_{CC} | 0 | V_{CC} | V | |
| $\Delta t/\Delta v$ | Input transition rise/fall time | $V_{CC} = 2$ V | | | 1000 | 1000 | ns | |
| | | $V_{CC} = 4.5$ V | | | 500 | 500 | | |
| | | $V_{CC} = 6$ V | | | 400 | 400 | | |
| T_A | Operating free-air temperature | -55 | | 125 | -40 | 85 | °C | |

NOTE 3: All unused inputs of the device must be held at V_{CC} or GND to ensure proper device operation. Refer to the TI application report, *Implications of Slow or Floating CMOS Inputs*, literature number SCBA004.



POST OFFICE BOX 655303 • DALLAS, TEXAS 75265

SN54HC02, SN74HC02 QUADRUPLE 2-INPUT POSITIVE-NOR GATES

SCLS076E – DECEMBER 1982 – REVISED AUGUST 2003

electrical characteristics over recommended operating free-air temperature range (unless otherwise noted)

| PARAMETER | TEST CONDITIONS | | V _{CC} | T _A = 25°C | | | SN54HC02 | | SN74HC02 | | UNIT |
|-----------------|---|---------------------------|-----------------|-----------------------|-------|------|----------|-------|----------|-------|------|
| | | | | MIN | TYP | MAX | MIN | MAX | MIN | MAX | |
| V _{OH} | V _I = V _{IH} or V _{IL} | I _{OH} = -20 μA | 2 V | 1.9 | 1.998 | | 1.9 | | 1.9 | V | |
| | | | 4.5 V | 4.4 | 4.499 | | 4.4 | | 4.4 | | |
| | | | 6 V | 5.9 | 5.999 | | 5.9 | | 5.9 | | |
| | | I _{OH} = -4 mA | 4.5 V | 3.98 | 4.3 | | 3.7 | | 3.84 | | |
| | | I _{OH} = -5.2 mA | 6 V | 5.48 | 5.8 | | 5.2 | | 5.34 | | |
| V _{OL} | V _I = V _{IH} or V _{IL} | I _{OL} = 20 μA | 2 V | | 0.002 | 0.1 | | 0.1 | | 0.1 | V |
| | | | 4.5 V | | 0.001 | 0.1 | | 0.1 | | 0.1 | |
| | | | 6 V | | 0.001 | 0.1 | | 0.1 | | 0.1 | |
| | | I _{OL} = 4 mA | 4.5 V | | 0.17 | 0.26 | | 0.4 | | 0.33 | |
| | | I _{OL} = 5.2 mA | 6 V | | 0.15 | 0.26 | | 0.4 | | 0.33 | |
| I _I | V _I = V _{CC} or 0 | | 6 V | | ±0.1 | ±100 | | ±1000 | | ±1000 | nA |
| I _{CC} | V _I = V _{CC} or 0, I _O = 0 | | 6 V | | | 2 | | 40 | | 20 | μA |
| C _i | | | 2 V to 6 V | | 3 | 10 | | 10 | | 10 | pF |

switching characteristics over recommended operating free-air temperature range, C_L = 50 pF (unless otherwise noted) (see Figure 1)

| PARAMETER | FROM (INPUT) | TO (OUTPUT) | V _{CC} | T _A = 25°C | | | SN54HC02 | | SN74HC02 | | UNIT |
|-----------------|--------------|-------------|-----------------|-----------------------|-----|-----|----------|-----|----------|-----|------|
| | | | | MIN | TYP | MAX | MIN | MAX | MIN | MAX | |
| t _{pd} | A or B | Y | 2 V | | 45 | 90 | | 135 | | 115 | ns |
| | | | 4.5 V | | 9 | 18 | | 27 | | 23 | |
| | | | 6 V | | 8 | 15 | | 23 | | 20 | |
| t _t | | Y | 2 V | | 38 | 75 | | 110 | | 95 | ns |
| | | | 4.5 V | | 8 | 15 | | 22 | | 19 | |
| | | | 6 V | | 6 | 13 | | 19 | | 16 | |

operating characteristics, T_A = 25°C

| PARAMETER | TEST CONDITIONS | TYP | UNIT |
|--|-----------------|-----|------|
| C _{pd} Power dissipation capacitance per gate | No load | 22 | pF |



SN54HC02, SN74HC02 QUADRUPLE 2-INPUT POSITIVE-NOR GATES

SCLS076E – DECEMBER 1982 – REVISED AUGUST 2003

PARAMETER MEASUREMENT INFORMATION

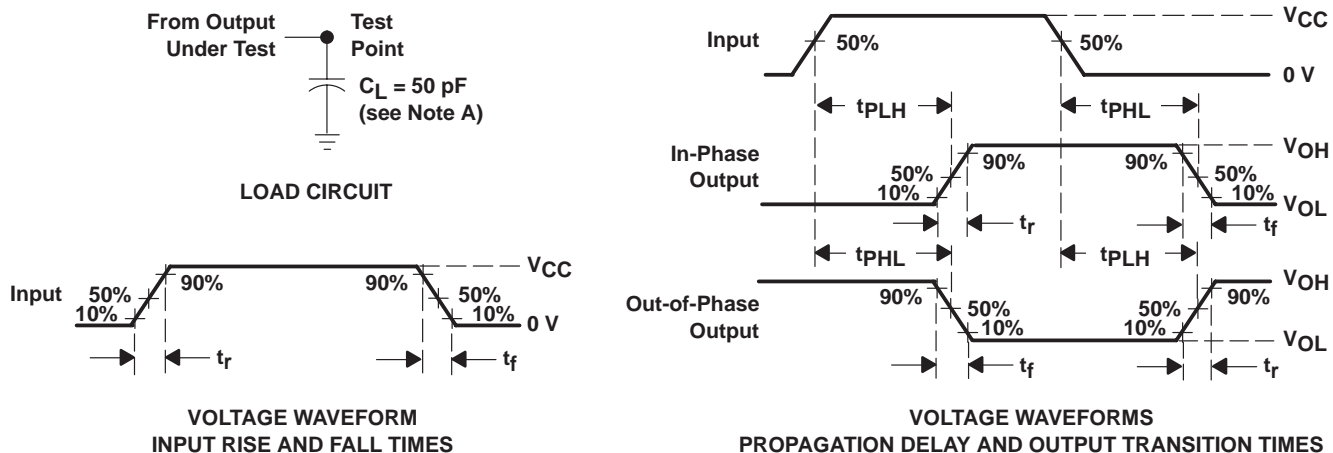

- NOTES:
- A. C_L includes probe and test-fixture capacitance.
 - B. Phase relationships between waveforms were chosen arbitrarily. All input pulses are supplied by generators having the following characteristics: $PRR \leq 1 \text{ MHz}$, $Z_O = 50 \Omega$, $t_r = 6 \text{ ns}$, $t_f = 6 \text{ ns}$.
 - C. The outputs are measured one at a time with one input transition per measurement.
 - D. t_{PLH} and t_{PHL} are the same as t_{pd} .

Figure 1. Load Circuit and Voltage Waveforms

PACKAGING INFORMATION

| Orderable Device | Status (1) | Package Type | Package Drawing | Pins | Package Qty | Eco Plan (2) | Lead/Ball Finish | MSL Peak Temp (3) | Op Temp (°C) | Top-Side Markings (4) | Samples |
|------------------|---------------|--------------|--------------------|------|----------------|----------------------------|------------------|----------------------|--------------|-----------------------------------|-------------------------|
| 5962-8404101VCA | ACTIVE | CDIP | J | 14 | 1 | TBD | A42 | N / A for Pkg Type | -55 to 125 | 5962-8404101VC A SNV54HC02J | Samples |
| 5962-8404101VDA | ACTIVE | CFP | W | 14 | 25 | TBD | A42 | N / A for Pkg Type | -55 to 125 | 5962-8404101VD A SNV54HC02W | Samples |
| 84041012A | ACTIVE | LCCC | FK | 20 | 1 | TBD | Call TI | Call TI | -55 to 125 | 84041012A SNJ54HC 02FK | Samples |
| 8404101CA | ACTIVE | CDIP | J | 14 | 1 | TBD | Call TI | Call TI | -55 to 125 | 8404101CA SNJ54HC02J | Samples |
| 8404101DA | ACTIVE | CFP | W | 14 | 1 | TBD | Call TI | Call TI | -55 to 125 | 8404101DA SNJ54HC02W | Samples |
| JM38510/65101B2A | ACTIVE | LCCC | FK | 20 | 1 | TBD | POST-PLATE | N / A for Pkg Type | -55 to 125 | JM38510/ 65101B2A | Samples |
| JM38510/65101BCA | ACTIVE | CDIP | J | 14 | 1 | TBD | A42 | N / A for Pkg Type | -55 to 125 | JM38510/ 65101BCA | Samples |
| JM38510/65101BDA | ACTIVE | CFP | W | 14 | 1 | TBD | A42 | N / A for Pkg Type | -55 to 125 | JM38510/ 65101BDA | Samples |
| M38510/65101B2A | ACTIVE | LCCC | FK | 20 | 1 | TBD | POST-PLATE | N / A for Pkg Type | -55 to 125 | JM38510/ 65101B2A | Samples |
| M38510/65101BCA | ACTIVE | CDIP | J | 14 | 1 | TBD | A42 | N / A for Pkg Type | -55 to 125 | JM38510/ 65101BCA | Samples |
| M38510/65101BDA | ACTIVE | CFP | W | 14 | 1 | TBD | A42 | N / A for Pkg Type | -55 to 125 | JM38510/ 65101BDA | Samples |
| SN54HC02J | ACTIVE | CDIP | J | 14 | 1 | TBD | A42 | N / A for Pkg Type | -55 to 125 | SN54HC02J | Samples |
| SN74HC02D | ACTIVE | SOIC | D | 14 | 50 | Green (RoHS & no Sb/Br) | CU NIPDAU | Level-1-260C-UNLIM | -40 to 85 | HC02 | Samples |
| SN74HC02DBLE | OBSOLETE | SSOP | DB | 14 | | TBD | Call TI | Call TI | -40 to 85 | | |
| SN74HC02DBR | ACTIVE | SSOP | DB | 14 | 2000 | Green (RoHS & no Sb/Br) | CU NIPDAU | Level-1-260C-UNLIM | -40 to 85 | HC02 | Samples |
| SN74HC02DBRE4 | ACTIVE | SSOP | DB | 14 | 2000 | Green (RoHS & no Sb/Br) | CU NIPDAU | Level-1-260C-UNLIM | -40 to 85 | HC02 | Samples |

| Orderable Device | Status (1) | Package Type | Package Drawing | Pins | Package Qty | Eco Plan (2) | Lead/Ball Finish | MSL Peak Temp (3) | Op Temp (°C) | Top-Side Markings (4) | Samples |
|------------------|---------------|--------------|-----------------|------|-------------|-------------------------|------------------|----------------------|--------------|--------------------------|-------------------------|
| SN74HC02DBRG4 | ACTIVE | SSOP | DB | 14 | 2000 | Green (RoHS & no Sb/Br) | CU NIPDAU | Level-1-260C-UNLIM | -40 to 85 | HC02 | Samples |
| SN74HC02DE4 | ACTIVE | SOIC | D | 14 | 50 | Green (RoHS & no Sb/Br) | CU NIPDAU | Level-1-260C-UNLIM | -40 to 85 | HC02 | Samples |
| SN74HC02DG4 | ACTIVE | SOIC | D | 14 | 50 | Green (RoHS & no Sb/Br) | CU NIPDAU | Level-1-260C-UNLIM | -40 to 85 | HC02 | Samples |
| SN74HC02DR | ACTIVE | SOIC | D | 14 | 2500 | Green (RoHS & no Sb/Br) | CU NIPDAU | Level-1-260C-UNLIM | -40 to 85 | HC02 | Samples |
| SN74HC02DRE4 | ACTIVE | SOIC | D | 14 | 2500 | Green (RoHS & no Sb/Br) | CU NIPDAU | Level-1-260C-UNLIM | -40 to 85 | HC02 | Samples |
| SN74HC02DRG4 | ACTIVE | SOIC | D | 14 | 2500 | Green (RoHS & no Sb/Br) | CU NIPDAU | Level-1-260C-UNLIM | -40 to 85 | HC02 | Samples |
| SN74HC02DT | ACTIVE | SOIC | D | 14 | 250 | Green (RoHS & no Sb/Br) | CU NIPDAU | Level-1-260C-UNLIM | -40 to 85 | HC02 | Samples |
| SN74HC02DTE4 | ACTIVE | SOIC | D | 14 | 250 | Green (RoHS & no Sb/Br) | CU NIPDAU | Level-1-260C-UNLIM | -40 to 85 | HC02 | Samples |
| SN74HC02DTG4 | ACTIVE | SOIC | D | 14 | 250 | Green (RoHS & no Sb/Br) | CU NIPDAU | Level-1-260C-UNLIM | -40 to 85 | HC02 | Samples |
| SN74HC02N | ACTIVE | PDIP | N | 14 | 25 | Pb-Free (RoHS) | CU NIPDAU | N / A for Pkg Type | -40 to 85 | SN74HC02N | Samples |
| SN74HC02N3 | OBSOLETE | PDIP | N | 14 | | TBD | Call TI | Call TI | -40 to 85 | | |
| SN74HC02NE4 | ACTIVE | PDIP | N | 14 | 25 | Pb-Free (RoHS) | CU NIPDAU | N / A for Pkg Type | -40 to 85 | SN74HC02N | Samples |
| SN74HC02NSR | ACTIVE | SO | NS | 14 | 2000 | Green (RoHS & no Sb/Br) | CU NIPDAU | Level-1-260C-UNLIM | -40 to 85 | HC02 | Samples |
| SN74HC02NSRG4 | ACTIVE | SO | NS | 14 | 2000 | Green (RoHS & no Sb/Br) | CU NIPDAU | Level-1-260C-UNLIM | -40 to 85 | HC02 | Samples |
| SN74HC02PW | ACTIVE | TSSOP | PW | 14 | 90 | Green (RoHS & no Sb/Br) | CU NIPDAU | Level-1-260C-UNLIM | -40 to 85 | HC02 | Samples |
| SN74HC02PWE4 | ACTIVE | TSSOP | PW | 14 | 90 | Green (RoHS & no Sb/Br) | CU NIPDAU | Level-1-260C-UNLIM | -40 to 85 | HC02 | Samples |
| SN74HC02PWG4 | ACTIVE | TSSOP | PW | 14 | 90 | Green (RoHS & no Sb/Br) | CU NIPDAU | Level-1-260C-UNLIM | -40 to 85 | HC02 | Samples |
| SN74HC02PWLE | OBSOLETE | TSSOP | PW | 14 | | TBD | Call TI | Call TI | -40 to 85 | | |
| SN74HC02PWR | ACTIVE | TSSOP | PW | 14 | 2000 | Green (RoHS & no Sb/Br) | CU NIPDAU | Level-1-260C-UNLIM | -40 to 85 | HC02 | Samples |

| Orderable Device | Status (1) | Package Type | Package Drawing | Pins | Package Qty | Eco Plan (2) | Lead/Ball Finish | MSL Peak Temp (3) | Op Temp (°C) | Top-Side Markings (4) | Samples |
|------------------|---------------|--------------|-----------------|------|-------------|-------------------------|------------------|----------------------|--------------|------------------------------|-------------------------|
| SN74HC02PWRE4 | ACTIVE | TSSOP | PW | 14 | 2000 | Green (RoHS & no Sb/Br) | CU NIPDAU | Level-1-260C-UNLIM | -40 to 85 | HC02 | Samples |
| SN74HC02PWRG4 | ACTIVE | TSSOP | PW | 14 | 2000 | Green (RoHS & no Sb/Br) | CU NIPDAU | Level-1-260C-UNLIM | -40 to 85 | HC02 | Samples |
| SN74HC02PWT | ACTIVE | TSSOP | PW | 14 | 250 | Green (RoHS & no Sb/Br) | CU NIPDAU | Level-1-260C-UNLIM | -40 to 85 | HC02 | Samples |
| SN74HC02PWTE4 | ACTIVE | TSSOP | PW | 14 | 250 | Green (RoHS & no Sb/Br) | CU NIPDAU | Level-1-260C-UNLIM | -40 to 85 | HC02 | Samples |
| SN74HC02PWTG4 | ACTIVE | TSSOP | PW | 14 | 250 | Green (RoHS & no Sb/Br) | CU NIPDAU | Level-1-260C-UNLIM | -40 to 85 | HC02 | Samples |
| SNJ54HC02FK | ACTIVE | LCCC | FK | 20 | 1 | TBD | POST-PLATE | N / A for Pkg Type | -55 to 125 | 84041012A SNJ54HC 02FK | Samples |
| SNJ54HC02J | ACTIVE | CDIP | J | 14 | 1 | TBD | A42 | N / A for Pkg Type | -55 to 125 | 8404101CA SNJ54HC02J | Samples |
| SNJ54HC02W | ACTIVE | CFP | W | 14 | 1 | TBD | A42 | N / A for Pkg Type | -55 to 125 | 8404101DA SNJ54HC02W | Samples |

(1) The marketing status values are defined as follows:

ACTIVE: Product device recommended for new designs.

LIFEBUY: TI has announced that the device will be discontinued, and a lifetime-buy period is in effect.

NRND: Not recommended for new designs. Device is in production to support existing customers, but TI does not recommend using this part in a new design.

PREVIEW: Device has been announced but is not in production. Samples may or may not be available.

OBSOLETE: TI has discontinued the production of the device.

(2) Eco Plan - The planned eco-friendly classification: Pb-Free (RoHS), Pb-Free (RoHS Exempt), or Green (RoHS & no Sb/Br) - please check <http://www.ti.com/productcontent> for the latest availability information and additional product content details.

TBD: The Pb-Free/Green conversion plan has not been defined.

Pb-Free (RoHS): TI's terms "Lead-Free" or "Pb-Free" mean semiconductor products that are compatible with the current RoHS requirements for all 6 substances, including the requirement that lead not exceed 0.1% by weight in homogeneous materials. Where designed to be soldered at high temperatures, TI Pb-Free products are suitable for use in specified lead-free processes.

Pb-Free (RoHS Exempt): This component has a RoHS exemption for either 1) lead-based flip-chip solder bumps used between the die and package, or 2) lead-based die adhesive used between the die and leadframe. The component is otherwise considered Pb-Free (RoHS compatible) as defined above.

Green (RoHS & no Sb/Br): TI defines "Green" to mean Pb-Free (RoHS compatible), and free of Bromine (Br) and Antimony (Sb) based flame retardants (Br or Sb do not exceed 0.1% by weight in homogeneous material)

(3) MSL, Peak Temp. -- The Moisture Sensitivity Level rating according to the JEDEC industry standard classifications, and peak solder temperature.

⁽⁴⁾ Multiple Top-Side Markings will be inside parentheses. Only one Top-Side Marking contained in parentheses and separated by a "~" will appear on a device. If a line is indented then it is a continuation of the previous line and the two combined represent the entire Top-Side Marking for that device.

Important Information and Disclaimer: The information provided on this page represents TI's knowledge and belief as of the date that it is provided. TI bases its knowledge and belief on information provided by third parties, and makes no representation or warranty as to the accuracy of such information. Efforts are underway to better integrate information from third parties. TI has taken and continues to take reasonable steps to provide representative and accurate information but may not have conducted destructive testing or chemical analysis on incoming materials and chemicals. TI and TI suppliers consider certain information to be proprietary, and thus CAS numbers and other limited information may not be available for release.

In no event shall TI's liability arising out of such information exceed the total purchase price of the TI part(s) at issue in this document sold by TI to Customer on an annual basis.

OTHER QUALIFIED VERSIONS OF SN54HC02, SN54HC02-SP, SN74HC02 :

- Catalog: [SN74HC02](#), [SN54HC02](#)

- Automotive: [SN74HC02-Q1](#), [SN74HC02-Q1](#)

- Enhanced Product: [SN74HC02-EP](#), [SN74HC02-EP](#)

- Military: [SN54HC02](#)

- Space: [SN54HC02-SP](#)

NOTE: Qualified Version Definitions:

- Catalog - TI's standard catalog product

- Automotive - Q100 devices qualified for high-reliability automotive applications targeting zero defects

- Enhanced Product - Supports Defense, Aerospace and Medical Applications

- Military - QML certified for Military and Defense Applications

- Space - Radiation tolerant, ceramic packaging and qualified for use in Space-based application

TAPE AND REEL INFORMATION

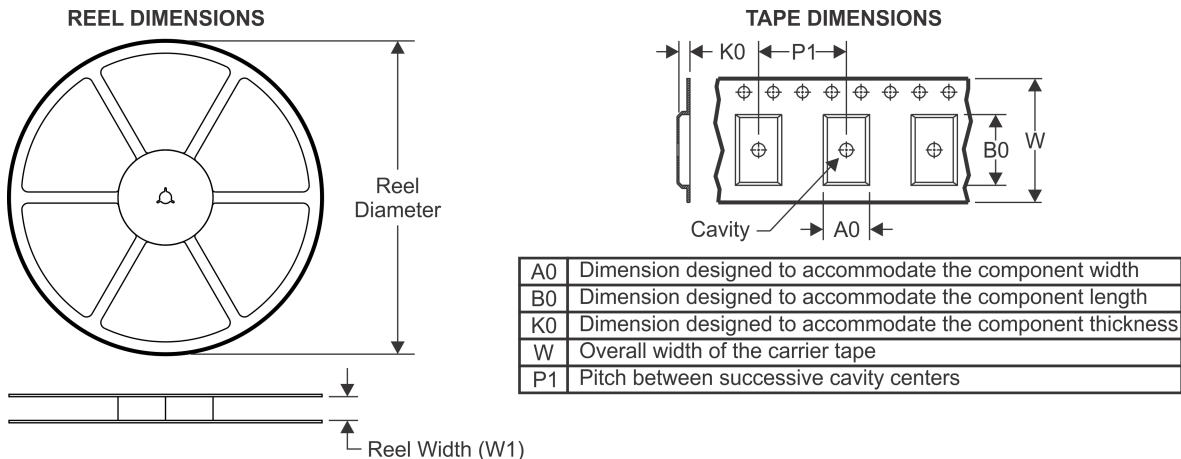

QUADRANT ASSIGNMENTS FOR PIN 1 ORIENTATION IN TAPE



*All dimensions are nominal

| Device | Package Type | Package Drawing | Pins | SPQ | Reel Diameter (mm) | Reel Width W1 (mm) | A0 (mm) | B0 (mm) | K0 (mm) | P1 (mm) | W (mm) | Pin1 Quadrant |
|--------------|--------------|-----------------|------|------|--------------------|--------------------|---------|---------|---------|---------|--------|---------------|
| SN74HC02DBR | SSOP | DB | 14 | 2000 | 330.0 | 16.4 | 8.2 | 6.6 | 2.5 | 12.0 | 16.0 | Q1 |
| SN74HC02DR | SOIC | D | 14 | 2500 | 330.0 | 16.4 | 6.5 | 9.0 | 2.1 | 8.0 | 16.0 | Q1 |
| SN74HC02DR | SOIC | D | 14 | 2500 | 330.0 | 16.4 | 6.5 | 9.0 | 2.1 | 8.0 | 16.0 | Q1 |
| SN74HC02DRG4 | SOIC | D | 14 | 2500 | 330.0 | 16.4 | 6.5 | 9.0 | 2.1 | 8.0 | 16.0 | Q1 |
| SN74HC02DRG4 | SOIC | D | 14 | 2500 | 330.0 | 16.4 | 6.5 | 9.0 | 2.1 | 8.0 | 16.0 | Q1 |
| SN74HC02DT | SOIC | D | 14 | 250 | 330.0 | 16.4 | 6.5 | 9.0 | 2.1 | 8.0 | 16.0 | Q1 |
| SN74HC02PWR | TSSOP | PW | 14 | 2000 | 330.0 | 12.4 | 6.9 | 5.6 | 1.6 | 8.0 | 12.0 | Q1 |
| SN74HC02PWT | TSSOP | PW | 14 | 250 | 330.0 | 12.4 | 6.9 | 5.6 | 1.6 | 8.0 | 12.0 | Q1 |

TAPE AND REEL BOX DIMENSIONS

*All dimensions are nominal

| Device | Package Type | Package Drawing | Pins | SPQ | Length (mm) | Width (mm) | Height (mm) |
|--------------|--------------|-----------------|------|------|-------------|------------|-------------|
| SN74HC02DBR | SSOP | DB | 14 | 2000 | 367.0 | 367.0 | 38.0 |
| SN74HC02DR | SOIC | D | 14 | 2500 | 333.2 | 345.9 | 28.6 |
| SN74HC02DR | SOIC | D | 14 | 2500 | 367.0 | 367.0 | 38.0 |
| SN74HC02DRG4 | SOIC | D | 14 | 2500 | 367.0 | 367.0 | 38.0 |
| SN74HC02DRG4 | SOIC | D | 14 | 2500 | 333.2 | 345.9 | 28.6 |
| SN74HC02DT | SOIC | D | 14 | 250 | 367.0 | 367.0 | 38.0 |
| SN74HC02PWR | TSSOP | PW | 14 | 2000 | 367.0 | 367.0 | 35.0 |
| SN74HC02PWT | TSSOP | PW | 14 | 250 | 367.0 | 367.0 | 35.0 |

J (R-GDIP-T**)

14 LEADS SHOWN

CERAMIC DUAL IN-LINE PACKAGE



| DIM \ PINS ** | 14 | 16 | 18 | 20 |
|---------------|------------------------|------------------------|------------------------|------------------------|
| A | 0.300 (7,62) BSC | 0.300 (7,62) BSC | 0.300 (7,62) BSC | 0.300 (7,62) BSC |
| B MAX | 0.785 (19,94) | .840 (21,34) | 0.960 (24,38) | 1.060 (26,92) |
| B MIN | — | — | — | — |
| C MAX | 0.300 (7,62) | 0.300 (7,62) | 0.310 (7,87) | 0.300 (7,62) |
| C MIN | 0.245 (6,22) | 0.245 (6,22) | 0.220 (5,59) | 0.245 (6,22) |



4040083/F 03/03

- NOTES:
- All linear dimensions are in inches (millimeters).
 - This drawing is subject to change without notice.
 - This package is hermetically sealed with a ceramic lid using glass frit.
 - Index point is provided on cap for terminal identification only on press ceramic glass frit seal only.
 - Falls within MIL STD 1835 GDIP1-T14, GDIP1-T16, GDIP1-T18 and GDIP1-T20.

FK (S-CQCC-N**)

LEADLESS CERAMIC CHIP CARRIER

28 TERMINAL SHOWN

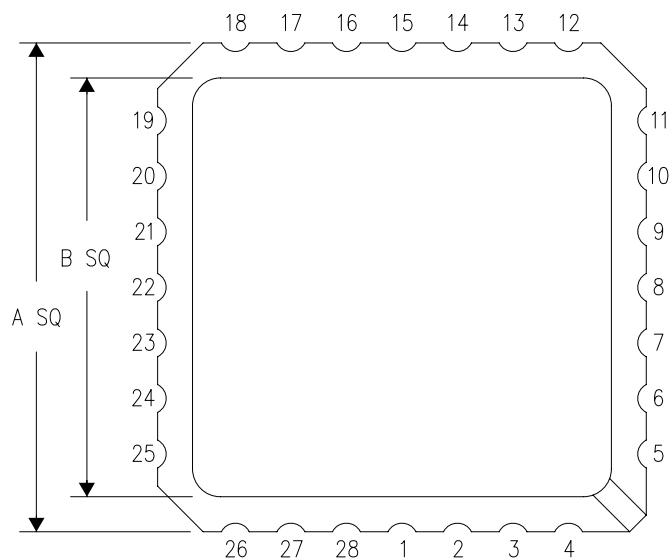

| NO. OF TERMINALS ** | A | | B | |
|---------------------|------------------|------------------|------------------|------------------|
| | MIN | MAX | MIN | MAX |
| 20 | 0.342 (8,69) | 0.358 (9,09) | 0.307 (7,80) | 0.358 (9,09) |
| 28 | 0.442 (11,23) | 0.458 (11,63) | 0.406 (10,31) | 0.458 (11,63) |
| 44 | 0.640 (16,26) | 0.660 (16,76) | 0.495 (12,58) | 0.560 (14,22) |
| 52 | 0.740 (18,78) | 0.761 (19,32) | 0.495 (12,58) | 0.560 (14,22) |
| 68 | 0.938 (23,83) | 0.962 (24,43) | 0.850 (21,6) | 0.858 (21,8) |
| 84 | 1.141 (28,99) | 1.165 (29,59) | 1.047 (26,6) | 1.063 (27,0) |



4040140/D 01/11

- NOTES:
- All linear dimensions are in inches (millimeters).
 - This drawing is subject to change without notice.
 - This package can be hermetically sealed with a metal lid.
 - Falls within JEDEC MS-004

N (R-PDIP-T**)

PLASTIC DUAL-IN-LINE PACKAGE

16 PINS SHOWN





- NOTES:
- A. All linear dimensions are in inches (millimeters).
 - B. This drawing is subject to change without notice.
 - Falls within JEDEC MS-001, except 18 and 20 pin minimum body length (Dim A).
 - The 20 pin end lead shoulder width is a vendor option, either half or full width.

D (R-PDSO-G14)

PLASTIC SMALL OUTLINE



4040047-5/M 06/11

- NOTES:
- A. All linear dimensions are in inches (millimeters).
 - B. This drawing is subject to change without notice.
 -  Body length does not include mold flash, protrusions, or gate burrs. Mold flash, protrusions, or gate burrs shall not exceed 0.006 (0,15) each side.
 -  Body width does not include interlead flash. Interlead flash shall not exceed 0.017 (0,43) each side.
 - E. Reference JEDEC MS-012 variation AB.

D (R-PDSO-G14)

PLASTIC SMALL OUTLINE



- NOTES:
- All linear dimensions are in millimeters.
 - This drawing is subject to change without notice.
 - Publication IPC-7351 is recommended for alternate designs.
 - Laser cutting apertures with trapezoidal walls and also rounding corners will offer better paste release. Customers should contact their board assembly site for stencil design recommendations. Refer to IPC-7525 for other stencil recommendations.
 - Customers should contact their board fabrication site for solder mask tolerances between and around signal pads.

PW (R-PDSO-G14)

PLASTIC SMALL OUTLINE

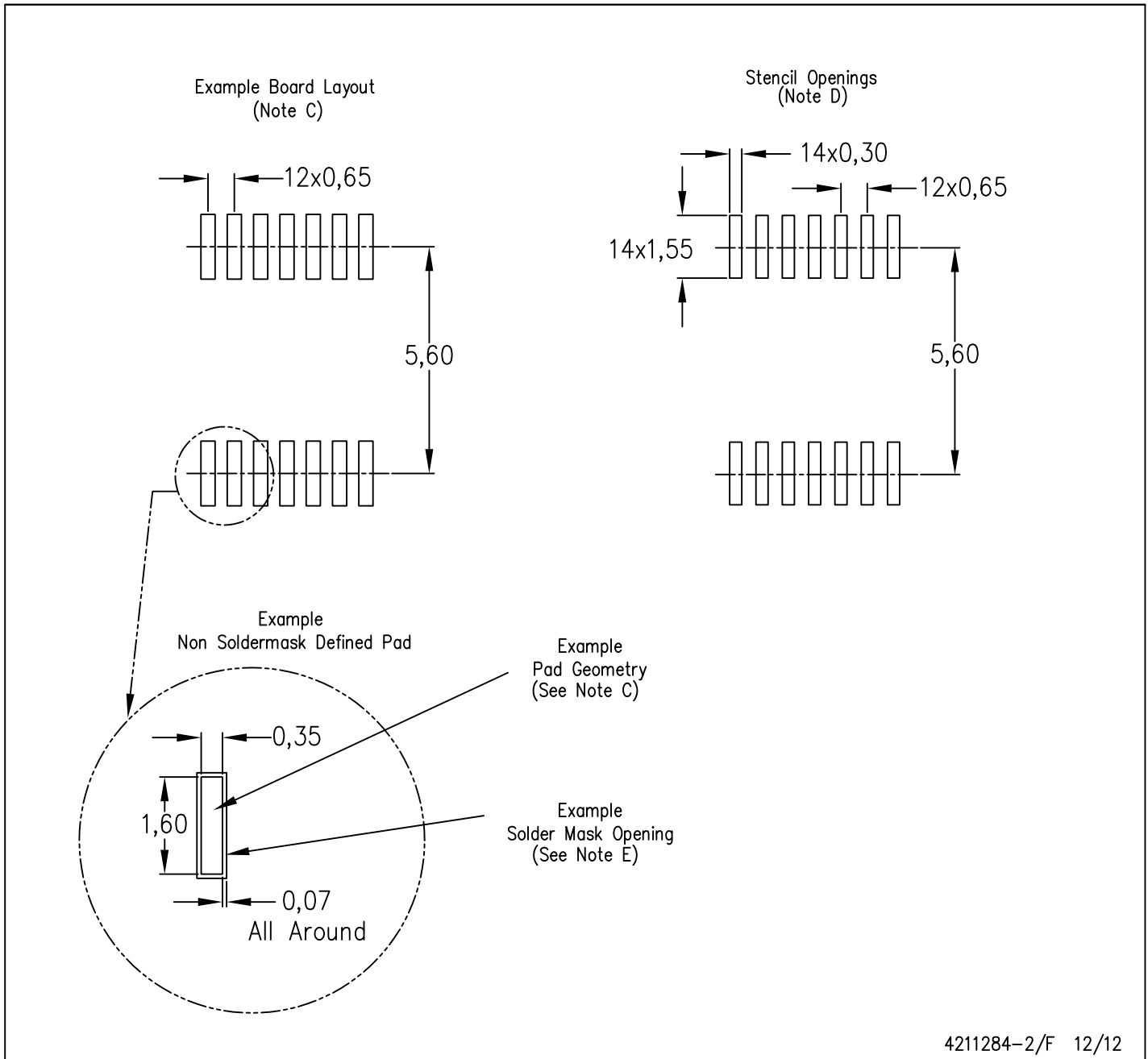

- NOTES:
- All linear dimensions are in millimeters.
 - This drawing is subject to change without notice.
 - Publication IPC-7351 is recommended for alternate designs.
 - Laser cutting apertures with trapezoidal walls and also rounding corners will offer better paste release. Customers should contact their board assembly site for stencil design recommendations. Refer to IPC-7525 for other stencil recommendations.
 - Customers should contact their board fabrication site for solder mask tolerances between and around signal pads.

MECHANICAL DATA

NS (R-PDSO-G**)

PLASTIC SMALL-OUTLINE PACKAGE

14-PINS SHOWN



- NOTES:
- A. All linear dimensions are in millimeters.
 - B. This drawing is subject to change without notice.
 - C. Body dimensions do not include mold flash or protrusion, not to exceed 0,15.

DB (R-PDSO-G**)

PLASTIC SMALL-OUTLINE

28 PINS SHOWN



- NOTES: A. All linear dimensions are in millimeters.
 B. This drawing is subject to change without notice.
 C. Body dimensions do not include mold flash or protrusion not to exceed 0,15.
 D. Falls within JEDEC MO-150

IMPORTANT NOTICE

Texas Instruments Incorporated and its subsidiaries (TI) reserve the right to make corrections, enhancements, improvements and other changes to its semiconductor products and services per JESD46, latest issue, and to discontinue any product or service per JESD48, latest issue. Buyers should obtain the latest relevant information before placing orders and should verify that such information is current and complete. All semiconductor products (also referred to herein as "components") are sold subject to TI's terms and conditions of sale supplied at the time of order acknowledgment.

TI warrants performance of its components to the specifications applicable at the time of sale, in accordance with the warranty in TI's terms and conditions of sale of semiconductor products. Testing and other quality control techniques are used to the extent TI deems necessary to support this warranty. Except where mandated by applicable law, testing of all parameters of each component is not necessarily performed.

TI assumes no liability for applications assistance or the design of Buyers' products. Buyers are responsible for their products and applications using TI components. To minimize the risks associated with Buyers' products and applications, Buyers should provide adequate design and operating safeguards.

TI does not warrant or represent that any license, either express or implied, is granted under any patent right, copyright, mask work right, or other intellectual property right relating to any combination, machine, or process in which TI components or services are used. Information published by TI regarding third-party products or services does not constitute a license to use such products or services or a warranty or endorsement thereof. Use of such information may require a license from a third party under the patents or other intellectual property of the third party, or a license from TI under the patents or other intellectual property of TI.

Reproduction of significant portions of TI information in TI data books or data sheets is permissible only if reproduction is without alteration and is accompanied by all associated warranties, conditions, limitations, and notices. TI is not responsible or liable for such altered documentation. Information of third parties may be subject to additional restrictions.

Resale of TI components or services with statements different from or beyond the parameters stated by TI for that component or service voids all express and any implied warranties for the associated TI component or service and is an unfair and deceptive business practice. TI is not responsible or liable for any such statements.

Buyer acknowledges and agrees that it is solely responsible for compliance with all legal, regulatory and safety-related requirements concerning its products, and any use of TI components in its applications, notwithstanding any applications-related information or support that may be provided by TI. Buyer represents and agrees that it has all the necessary expertise to create and implement safeguards which anticipate dangerous consequences of failures, monitor failures and their consequences, lessen the likelihood of failures that might cause harm and take appropriate remedial actions. Buyer will fully indemnify TI and its representatives against any damages arising out of the use of any TI components in safety-critical applications.

In some cases, TI components may be promoted specifically to facilitate safety-related applications. With such components, TI's goal is to help enable customers to design and create their own end-product solutions that meet applicable functional safety standards and requirements. Nonetheless, such components are subject to these terms.

No TI components are authorized for use in FDA Class III (or similar life-critical medical equipment) unless authorized officers of the parties have executed a special agreement specifically governing such use.

Only those TI components which TI has specifically designated as military grade or "enhanced plastic" are designed and intended for use in military/aerospace applications or environments. Buyer acknowledges and agrees that any military or aerospace use of TI components which have **not** been so designated is solely at the Buyer's risk, and that Buyer is solely responsible for compliance with all legal and regulatory requirements in connection with such use.

TI has specifically designated certain components as meeting ISO/TS16949 requirements, mainly for automotive use. In any case of use of non-designated products, TI will not be responsible for any failure to meet ISO/TS16949.

Products

| | |
|------------------------------|--|
| Audio | www.ti.com/audio |
| Amplifiers | amplifier.ti.com |
| Data Converters | dataconverter.ti.com |
| DLP® Products | www.dlp.com |
| DSP | dsp.ti.com |
| Clocks and Timers | www.ti.com/clocks |
| Interface | interface.ti.com |
| Logic | logic.ti.com |
| Power Mgmt | power.ti.com |
| Microcontrollers | microcontroller.ti.com |
| RFID | www.ti-rfid.com |
| OMAP Applications Processors | www.ti.com/omap |
| Wireless Connectivity | www.ti.com/wirelessconnectivity |

Applications

| | |
|-------------------------------|--|
| Automotive and Transportation | www.ti.com/automotive |
| Communications and Telecom | www.ti.com/communications |
| Computers and Peripherals | www.ti.com/computers |
| Consumer Electronics | www.ti.com/consumer-apps |
| Energy and Lighting | www.ti.com/energy |
| Industrial | www.ti.com/industrial |
| Medical | www.ti.com/medical |
| Security | www.ti.com/security |
| Space, Avionics and Defense | www.ti.com/space-avionics-defense |
| Video and Imaging | www.ti.com/video |

TI E2E Community

e2e.ti.com