

SN54LV123A, SN74LV123A DUAL RETRIGGERABLE MONOSTABLE MULTIVIBRATORS WITH SCHMITT-TRIGGER INPUTS

SCLS3930 – APRIL 1998 – REVISED OCTOBER 2005

- 2-V to 5.5-V V_{CC} Operation
- Max t_{pd} of 11 ns at 5 V
- Typical V_{OLP} (Output Ground Bounce) <math><0.8\text{ V}</math> at $V_{CC} = 3.3\text{ V}$, $T_A = 25^\circ\text{C}$
- Typical V_{OHV} (Output V_{OH} Undershoot) >math>>2.3\text{ V}</math> at $V_{CC} = 3.3\text{ V}$, $T_A = 25^\circ\text{C}$
- Support Mixed-Mode Voltage Operation on All Ports
- Schmitt-Trigger Circuitry on \overline{A} , B, and \overline{CLR} Inputs for Slow Input Transition Rates
- Edge Triggered From Active-High or Active-Low Gated Logic Inputs
- I_{off} Supports Partial-Power-Down Mode Operation
- Retriggerable for Very Long Output Pulses, up to 100% Duty Cycle
- Overriding Clear Terminates Output Pulse
- Glitch-Free Power-Up Reset on Outputs
- Latch-Up Performance Exceeds 100 mA Per JESD 78, Class II
- ESD Protection Exceeds JESD 22
 - 2000-V Human-Body Model (A114-A)
 - 200-V Machine Model (A115-A)
 - 1000-V Charged-Device Model (C101)

SN54LV123A . . . J OR W PACKAGE
SN74LV123A . . . D, DB, DGV, NS,
OR PW PACKAGE
(TOP VIEW)

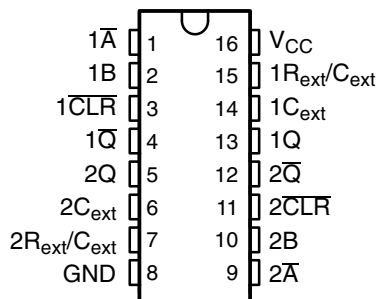

SN74LV123A . . . RGY PACKAGE
(TOP VIEW)

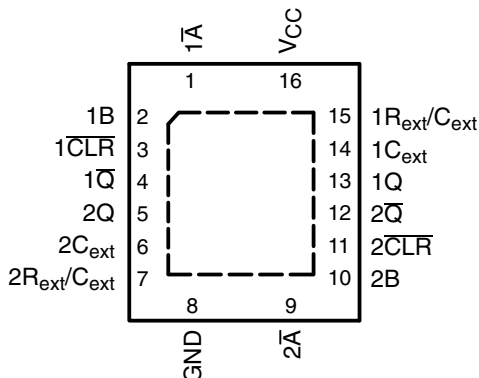

SN54LV123A . . . FK PACKAGE
(TOP VIEW)

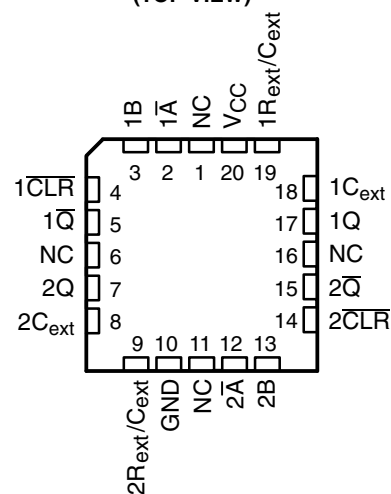

NC – No internal connection

description/ordering information

The 'LV123A devices are dual retriggerable monostable multivibrators designed for 2-V to 5.5-V V_{CC} operation.

These edge-triggered multivibrators feature output pulse-duration control by three methods. In the first method, the \overline{A} input is low and the B input goes high. In the second method, the B input is high and the \overline{A} input goes low. In the third method, the \overline{A} input is low, the B input is high, and the clear (\overline{CLR}) input goes high.

The output pulse duration is programmable by selecting external resistance and capacitance values. The external timing capacitor must be connected between C_{ext} and R_{ext}/C_{ext} (positive) and an external resistor connected between R_{ext}/C_{ext} and V_{CC} . To obtain variable pulse durations, connect an external variable resistance between R_{ext}/C_{ext} and V_{CC} . The output pulse duration also can be reduced by taking \overline{CLR} low.

Pulse triggering occurs at a particular voltage level and is not directly related to the transition time of the input pulse. The \overline{A} , B, and \overline{CLR} inputs have Schmitt triggers with sufficient hysteresis to handle slow input transition rates with jitter-free triggering at the outputs.

Once triggered, the basic pulse duration can be extended by retriggering the gated low-level-active (\overline{A}) or high-level-active (B) input. Pulse duration can be reduced by taking \overline{CLR} low. The input/output timing diagram illustrates pulse control by retriggering the inputs and early clearing.



Please be aware that an important notice concerning availability, standard warranty, and use in critical applications of Texas Instruments semiconductor products and disclaimers thereto appears at the end of this data sheet.

UNLESS OTHERWISE NOTED this document contains PRODUCTION DATA information current as of publication date. Products conform to specifications per the terms of Texas Instruments standard warranty. Production processing does not necessarily include testing of all parameters.

**TEXAS
INSTRUMENTS**

POST OFFICE BOX 655303 • DALLAS, TEXAS 75265

Copyright © 2005, Texas Instruments Incorporated

SN54LV123A, SN74LV123A DUAL RETRIGGERABLE MONOSTABLE MULTIVIBRATORS WITH SCHMITT-TRIGGER INPUTS

SCLS3930 – APRIL 1998 – REVISED OCTOBER 2005

description/ordering information (continued)

During power up, Q outputs are in the low state, and \bar{Q} outputs are in the high state. The outputs are glitch free, without applying a reset pulse.

These devices are fully specified for partial-power-down applications using I_{off} . The I_{off} circuitry disables the outputs, preventing damaging current backflow through the devices when they are powered down.







Pin assignments for these devices are identical to those of the 'AHC123A and 'AHCT123A devices for interchangeability, when allowed.

ORDERING INFORMATION

T_A	PACKAGE†		ORDERABLE PART NUMBER	TOP-SIDE MARKING
-40°C to 85°C	QFN – RGY	Reel of 1000	SN74LV123ARGYR	LV123A
	SOIC – D	Tube of 40	SN74LV123AD	LV123A
		Reel of 2500	SN74LV123ADR	
	SOP – NS	Reel of 2000	SN74LV123ANSR	74LV123A
	SSOP – DB	Reel of 2000	SN74LV123ADBR	LV123A
	TSSOP – PW	Tube of 90	SN74LV123APW	LV123A
		Reel of 2000	SN74LV123APWR	
Reel of 250		SN74LV123APWT		
TVSOP – DGV	Reel of 2000	SN74LV123ADGVR	LV123A	
-55°C to 125°C	CDIP – J	Tube of 25	SNJ54LV123AJ	SNJ54LV123AJ
	CFP – W	Tube of 150	SNJ54LV123AW	SNJ54LV123AW
	LCCC – FK	Tube of 55	SNJ54LV123AFK	SNJ54LV123AFK

† Package drawings, standard packing quantities, thermal data, symbolization, and PCB design guidelines are available at www.ti.com/sc/package.

FUNCTION TABLE (each multivibrator)

INPUTS			OUTPUTS	
CLR	\bar{A}	B	Q	\bar{Q}
L	X	X	L	H
X	H	X	L [‡]	H [‡]
X	X	L	L [‡]	H [‡]
H	L	↑		
H	↓	H		
↑	L	H		

‡ These outputs are based on the assumption that the indicated steady-state conditions at the \bar{A} and B inputs have been set up long enough to complete any pulse started before the setup.

SN54LV123A, SN74LV123A
DUAL RETRIGGERABLE MONOSTABLE MULTIVIBRATORS
WITH SCHMITT-TRIGGER INPUTS
SCLS3930 – APRIL 1998 – REVISED OCTOBER 2005

logic diagram, each multivibrator (positive logic)

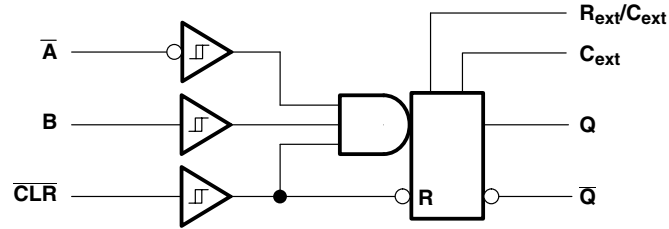

input/output timing diagram

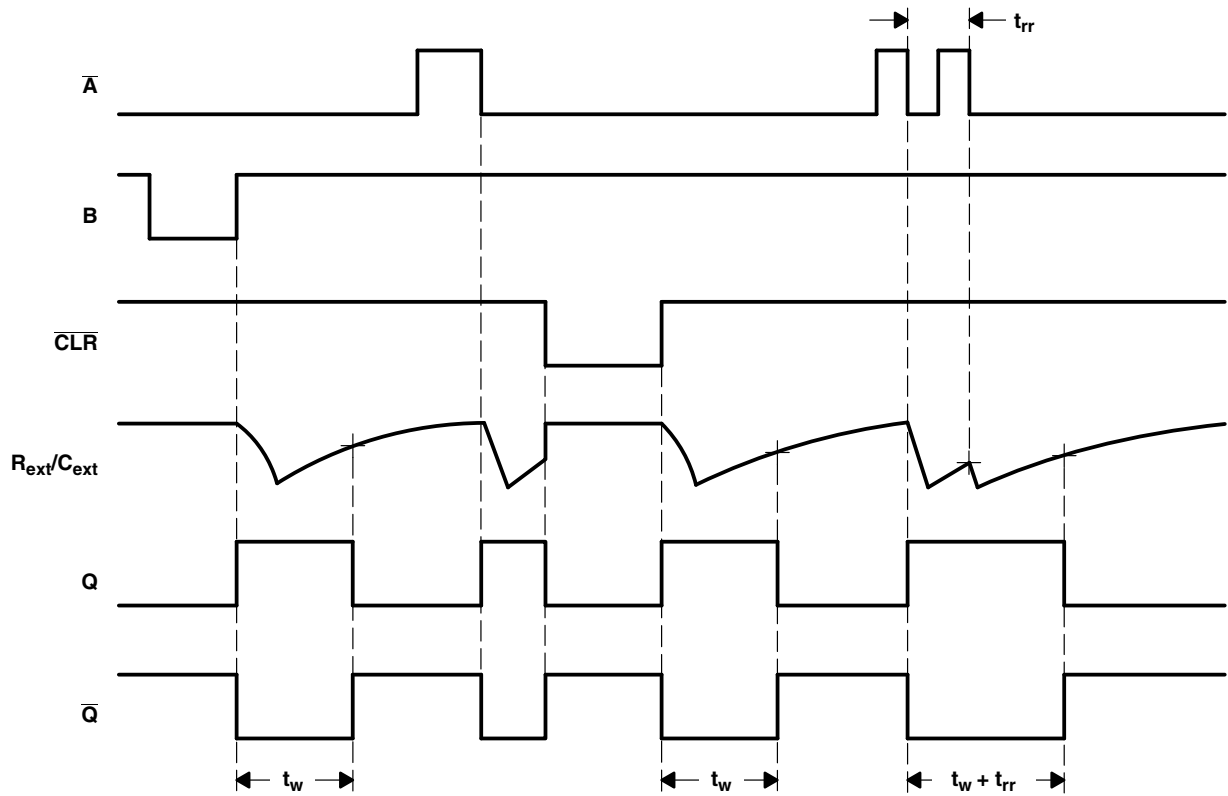

SN54LV123A, SN74LV123A DUAL RETRIGGERABLE MONOSTABLE MULTIVIBRATORS WITH SCHMITT-TRIGGER INPUTS

SCLS3930 – APRIL 1998 – REVISED OCTOBER 2005

absolute maximum ratings over operating free-air temperature (unless otherwise noted)†

Supply voltage range, V_{CC}	-0.5 V to 7 V
Input voltage range, V_I (see Note 1)	-0.5 V to 7 V
Voltage range applied to any output in the high-impedance or power-off state, V_O (see Note 1)	-0.5 V to 7 V
Output voltage range in high or low state, V_O (see Notes 1 and 2)	-0.5 V to $V_{CC} + 0.5$ V
Output voltage range in power-off state, V_O (see Note 1)	-0.5 V to 7 V
Input clamp current, I_{IK} ($V_I < 0$)	-20 mA
Output clamp current, I_{OK} ($V_O < 0$)	-50 mA
Continuous output current, I_O ($V_O = 0$ to V_{CC})	± 25 mA
Continuous current through V_{CC} or GND	± 50 mA
Package thermal impedance, θ_{JA} (see Note 3): D package	73°C/W
(see Note 3): DB package	82°C/W
(see Note 3): DGV package	120°C/W
(see Note 3): NS package	64°C/W
(see Note 3): PW package	108°C/W
(see Note 4): RGY package	39°C/W
Storage temperature range, T_{stg}	-65°C to 150°C

† Stresses beyond those listed under “absolute maximum ratings” may cause permanent damage to the device. These are stress ratings only, and functional operation of the device at these or any other conditions beyond those indicated under “recommended operating conditions” is not implied. Exposure to absolute-maximum-rated conditions for extended periods may affect device reliability.

- NOTES:
1. The input and output negative-voltage ratings may be exceeded if the input and output current ratings are observed.
 2. This value is limited to 5.5 V maximum.
 3. The package thermal impedance is calculated in accordance with JESD 51-7.
 4. The package thermal impedance is calculated in accordance with JESD 51-5.



SN54LV123A, SN74LV123A DUAL RETRIGGERABLE MONOSTABLE MULTIVIBRATORS WITH SCHMITT-TRIGGER INPUTS

SCLS3930 – APRIL 1998 – REVISED OCTOBER 2005

recommended operating conditions (see Note 5)

		SN54LV123A		SN74LV123A		UNIT
		MIN	MAX	MIN	MAX	
V _{CC}	Supply voltage	2	5.5	2	5.5	V
V _{IH}	High-level input voltage	V _{CC} = 2 V	1.5	1.5		V
		V _{CC} = 2.3 V to 2.7 V	V _{CC} × 0.7	V _{CC} × 0.7		
		V _{CC} = 3 V to 3.6 V	V _{CC} × 0.7	V _{CC} × 0.7		
		V _{CC} = 4.5 V to 5.5 V	V _{CC} × 0.7	V _{CC} × 0.7		
V _{IL}	Low-level input voltage	V _{CC} = 2 V	0.5	0.5		V
		V _{CC} = 2.3 V to 2.7 V	V _{CC} × 0.3	V _{CC} × 0.3		
		V _{CC} = 3 V to 3.6 V	V _{CC} × 0.3	V _{CC} × 0.3		
		V _{CC} = 4.5 V to 5.5 V	V _{CC} × 0.3	V _{CC} × 0.3		
V _I	Input voltage	0	5.5	0	5.5	V
V _O	Output voltage	0	V _{CC}	0	V _{CC}	V
I _{OH}	High-level output current	V _{CC} = 2 V		-50	-50	μA
		V _{CC} = 2.3 V to 2.7 V		-2	-2	mA
		V _{CC} = 3 V to 3.6 V		-6	-6	
		V _{CC} = 4.5 V to 5.5 V		-12	-12	
I _{OL}	Low-level output current	V _{CC} = 2 V		50	50	μA
		V _{CC} = 2.3 V to 2.7 V		2	2	mA
		V _{CC} = 3 V to 3.6 V		6	6	
		V _{CC} = 4.5 V to 5.5 V		12	12	
R _{ext}	External timing resistance	V _{CC} = 2 V	5k	5k		Ω
		V _{CC} ≥ 3 V	1k	1k		
C _{ext}	External timing capacitance	No restriction		No restriction		pF
Δt/ΔV _{CC}	Power-up ramp rate	1		1		ms/V
T _A	Operating free-air temperature	-55	125	-40	85	°C

NOTE 5: Unused R_{ext}/C_{ext} terminals should be left unconnected. All remaining unused inputs of the device must be held at V_{CC} or GND to ensure proper device operation. Refer to the TI application report, *Implications of Slow or Floating CMOS Inputs*, literature number SCBA004.

SN54LV123A, SN74LV123A DUAL RETRIGGERABLE MONOSTABLE MULTIVIBRATORS WITH SCHMITT-TRIGGER INPUTS

SCLS3930 – APRIL 1998 – REVISED OCTOBER 2005

electrical characteristics over recommended operating free-air temperature range (unless otherwise noted)

PARAMETER	TEST CONDITIONS	V _{CC}	SN54LV123A			SN74LV123A			UNIT
			MIN	TYP	MAX	MIN	TYP	MAX	
V _{OH}	I _{OH} = -50 μA	2 V to 5.5 V	V _{CC} -0.1			V _{CC} -0.1			V
	I _{OH} = -2 mA	2.3 V	2			2			
	I _{OH} = -6 mA	3 V	2.48			2.48			
	I _{OH} = -12 mA	4.5 V	3.8			3.8			
V _{OL}	I _{OL} = 50 μA	2 V to 5.5 V	0.1			0.1			V
	I _{OL} = 2 mA	2.3 V	0.4			0.4			
	I _{OL} = 6 mA	3 V	0.44			0.44			
	I _{OL} = 12 mA	4.5 V	0.55			0.55			
I _I	R _{ext} /C _{ext} [†]	V _I = 5.5 V or GND	2 V to 5.5 V			±2.5			μA
	\bar{A} , B, and \bar{CLR}	V _I = 5.5 V or GND	0 to 5.5 V			±1			
I _{CC}	Quiescent	V _I = V _{CC} or GND, I _O = 0	5.5 V			20			μA
I _{CC}	Active state (per circuit)	V _I = V _{CC} or GND, R _{ext} /C _{ext} = 0.5 V _{CC}	2.3 V			220			μA
			3 V			280			
			4.5 V			650			
			5.5 V			975			
I _{off}	V _I or V _O = 0 to 5.5 V	0			5			μA	
C _i	V _I = V _{CC} or GND	3.3 V			1.9			pF	
		5 V			1.9				

[†] This test is performed with the terminal in the off-state condition.

timing requirements over recommended operating free-air temperature range, V_{CC} = 2.5 V ± 0.2 V (unless otherwise noted) (see Figure 1)

	TEST CONDITIONS	T _A = 25°C			SN54LV123A		SN74LV123A		UNIT
		MIN	TYP	MAX	MIN	MAX	MIN	MAX	
t _w Pulse duration	\bar{CLR}	6			6.5		6.5		ns
	\bar{A} or B trigger	6			6.5		6.5		
t _{rr} Pulse retrigger time	R _{ext} = 1 kΩ	C _{ext} = 100 pF			‡		‡		ns
		C _{ext} = 0.01 μF			‡		‡		μs

[‡] See retriggering data in the application information section.

timing requirements over recommended operating free-air temperature range, V_{CC} = 3.3 V ± 0.3 V (unless otherwise noted) (see Figure 1)

	TEST CONDITIONS	T _A = 25°C			SN54LV123A		SN74LV123A		UNIT
		MIN	TYP	MAX	MIN	MAX	MIN	MAX	
t _w Pulse duration	\bar{CLR}	5			5		5		ns
	\bar{A} or B trigger	5			5		5		
t _{rr} Pulse retrigger time	R _{ext} = 1 kΩ	C _{ext} = 100 pF			‡		‡		ns
		C _{ext} = 0.01 μF			‡		‡		μs

[‡] See retriggering data in the application information section.

PRODUCT PREVIEW information concerns products in the formative or design phase of development. Characteristic data and other specifications are design goals. Texas Instruments reserves the right to change or discontinue these products without notice.



POST OFFICE BOX 655303 • DALLAS, TEXAS 75265

SN54LV123A, SN74LV123A DUAL RETRIGGERABLE MONOSTABLE MULTIVIBRATORS WITH SCHMITT-TRIGGER INPUTS

SCLS3930 – APRIL 1998 – REVISED OCTOBER 2005

timing requirements over recommended operating free-air temperature range, $V_{CC} = 5\text{ V} \pm 0.5\text{ V}$ (unless otherwise noted) (see Figure 1)

		TEST CONDITIONS		$T_A = 25^\circ\text{C}$			SN54LV123A		SN74LV123A		UNIT
				MIN	TYP	MAX	MIN	MAX	MIN	MAX	
t_w	Pulse duration	$\overline{\text{CLR}}$			5			5			ns
		$\overline{\text{A}}$ or B trigger			5			5			
t_{rr}	Pulse retrigger time	$R_{ext} = 1\text{ k}\Omega$	$C_{ext} = 100\text{ pF}$	†	59		†		†		ns
			$C_{ext} = 0.01\text{ }\mu\text{F}$	†	1.5		†		†		μs

† See retriggering data in the *application information* section.

switching characteristics over recommended operating free-air temperature range, $V_{CC} = 2.5\text{ V} \pm 0.2\text{ V}$ (unless otherwise noted) (see Figure 1)

PARAMETER	FROM (INPUT)	TO (OUTPUT)	TEST CONDITIONS	$T_A = 25^\circ\text{C}$			SN54LV123A		SN74LV123A		UNIT	
				MIN	TYP	MAX	MIN	MAX	MIN	MAX		
t_{pd}	$\overline{\text{A}}$ or B	Q or $\overline{\text{Q}}$	$C_L = 15\text{ pF}$	14.5*	31.4*		1*	37*	1	37	ns	
	$\overline{\text{CLR}}$	Q or $\overline{\text{Q}}$		13*	25*		1*	29.5*	1	29.5		
	$\overline{\text{CLR}}$ trigger	Q or $\overline{\text{Q}}$		15.1*	33.4*		1*	39*	1	39		
t_{pd}	$\overline{\text{A}}$ or B	Q or $\overline{\text{Q}}$	$C_L = 50\text{ pF}$	16.6	36		1	42	1	42	ns	
	$\overline{\text{CLR}}$	Q or $\overline{\text{Q}}$		14.7	32.8		1	34.5	1	34.5		
	$\overline{\text{CLR}}$ trigger	Q or $\overline{\text{Q}}$		17.4	38		1	44	1	44		
t_w^\ddagger		Q or $\overline{\text{Q}}$	$C_L = 50\text{ pF}$, $C_{ext} = 28\text{ pF}$, $R_{ext} = 2\text{ k}\Omega$		197	260		320		320	ns	
			$C_L = 50\text{ pF}$, $C_{ext} = 0.01\text{ }\mu\text{F}$, $R_{ext} = 10\text{ k}\Omega$	90	100	110		90	110	90	110	μs
			$C_L = 50\text{ pF}$, $C_{ext} = 0.1\text{ }\mu\text{F}$, $R_{ext} = 10\text{ k}\Omega$	0.9	1	1.1		0.9	1.1	0.9	1.1	ms
Δt_w^\S			$C_L = 50\text{ pF}$		± 1					%		

* On products compliant to MIL-PRF-38535, this parameter is not production tested.

† t_w = Duration of pulse at Q and $\overline{\text{Q}}$ outputs

§ Δt_w = Output pulse-duration variation (Q and $\overline{\text{Q}}$) between circuits in same package

PRODUCT PREVIEW information concerns products in the formative or design phase of development. Characteristic data and other specifications are design goals. Texas Instruments reserves the right to change or discontinue these products without notice.



POST OFFICE BOX 655303 • DALLAS, TEXAS 75265

SN54LV123A, SN74LV123A DUAL RETRIGGERABLE MONOSTABLE MULTIVIBRATORS WITH SCHMITT-TRIGGER INPUTS

SCLS3930 – APRIL 1998 – REVISED OCTOBER 2005

switching characteristics over recommended operating free-air temperature range, $V_{CC} = 3.3 V \pm 0.3 V$ (unless otherwise noted) (see Figure 1)

PARAMETER	FROM (INPUT)	TO (OUTPUT)	TEST CONDITIONS	$T_A = 25^\circ C$			SN54LV123A		SN74LV123A		UNIT
				MIN	TYP	MAX	MIN	MAX	MIN	MAX	
t_{pd}	\bar{A} or B	Q or \bar{Q}	$C_L = 15 pF$	10.2*	20.6*	1*	24*	1	24	ns	
	\bar{CLR}	Q or \bar{Q}		9.3*	15.8*	1*	18.5*	1	18.5		
	\bar{CLR} trigger	Q or \bar{Q}		10.6*	22.4*	1*	26*	1	26		
t_{pd}	\bar{A} or B	Q or \bar{Q}	$C_L = 50 pF$	11.8	24.1	1	27.5	1	27.5	ns	
	\bar{CLR}	Q or \bar{Q}		10.5	19.3	1	22	1	22		
	\bar{CLR} trigger	Q or \bar{Q}		12.3	25.9	1	29.5	1	29.5		
t_w^\dagger		Q or \bar{Q}	$C_L = 50 pF$, $C_{ext} = 28 pF$, $R_{ext} = 2 k\Omega$	182	240		300		300	ns	
			$C_L = 50 pF$, $C_{ext} = 0.01 \mu F$, $R_{ext} = 10 k\Omega$	90	100	110	90	110	90	110	μs
			$C_L = 50 pF$, $C_{ext} = 0.1 \mu F$, $R_{ext} = 10 k\Omega$	0.9	1	1.1	0.9	1.1	0.9	1.1	ms
Δt_w^\ddagger			$C_L = 50 pF$	± 1						%	

* On products compliant to MIL-PRF-38535, this parameter is not production tested.

$\dagger t_w$ = Duration of pulse at Q and \bar{Q} outputs

$\ddagger \Delta t_w$ = Output pulse-duration variation (Q and \bar{Q}) between circuits in same package

switching characteristics over recommended operating free-air temperature range, $V_{CC} = 5 V \pm 0.5 V$ (unless otherwise noted) (see Figure 1)

PARAMETER	FROM (INPUT)	TO (OUTPUT)	TEST CONDITIONS	$T_A = 25^\circ C$			SN54LV123A		SN74LV123A		UNIT
				MIN	TYP	MAX	MIN	MAX	MIN	MAX	
t_{pd}	\bar{A} or B	Q or \bar{Q}	$C_L = 15 pF$	7.1*	12*	1*	14*	1	14	ns	
	\bar{CLR}	Q or \bar{Q}		6.5*	9.4*	1*	11*	1	11		
	\bar{CLR} trigger	Q or \bar{Q}		7.4*	12.9*	1*	15*	1	15		
t_{pd}	\bar{A} or B	Q or \bar{Q}	$C_L = 50 pF$	8.3	14	1	16	1	16	ns	
	\bar{CLR}	Q or \bar{Q}		7.4	11.4	1	13	1	13		
	\bar{CLR} trigger	Q or \bar{Q}		8.7	14.9	1	17	1	17		
t_w^\dagger		Q or \bar{Q}	$C_L = 50 pF$, $C_{ext} = 28 pF$, $R_{ext} = 2 k\Omega$	167	200		240		240	ns	
			$C_L = 50 pF$, $C_{ext} = 0.01 \mu F$, $R_{ext} = 10 k\Omega$	90	100	110	90	110	90	110	μs
			$C_L = 50 pF$, $C_{ext} = 0.1 \mu F$, $R_{ext} = 10 k\Omega$	0.9	1	1.1	0.9	1.1	0.9	1.1	ms
Δt_w^\ddagger				± 1						%	

* On products compliant to MIL-PRF-38535, this parameter is not production tested.

$\dagger t_w$ = Duration of pulse at Q and \bar{Q} outputs

$\ddagger \Delta t_w$ = Output pulse-duration variation (Q and \bar{Q}) between circuits in same package

PRODUCT PREVIEW information concerns products in the formative or design phase of development. Characteristic data and other specifications are design goals. Texas Instruments reserves the right to change or discontinue these products without notice.



SN54LV123A, SN74LV123A DUAL RETRIGGERABLE MONOSTABLE MULTIVIBRATORS WITH SCHMITT-TRIGGER INPUTS

SCLS3930 – APRIL 1998 – REVISED OCTOBER 2005

operating characteristics, $T_A = 25^\circ\text{C}$

PARAMETER	TEST CONDITIONS	V_{CC}	TYP	UNIT
C_{pd} Power dissipation capacitance	$C_L = 50\text{ pF}, f = 10\text{ MHz}$	3.3 V	44	pF
		5 V	49	

PARAMETER MEASUREMENT INFORMATION

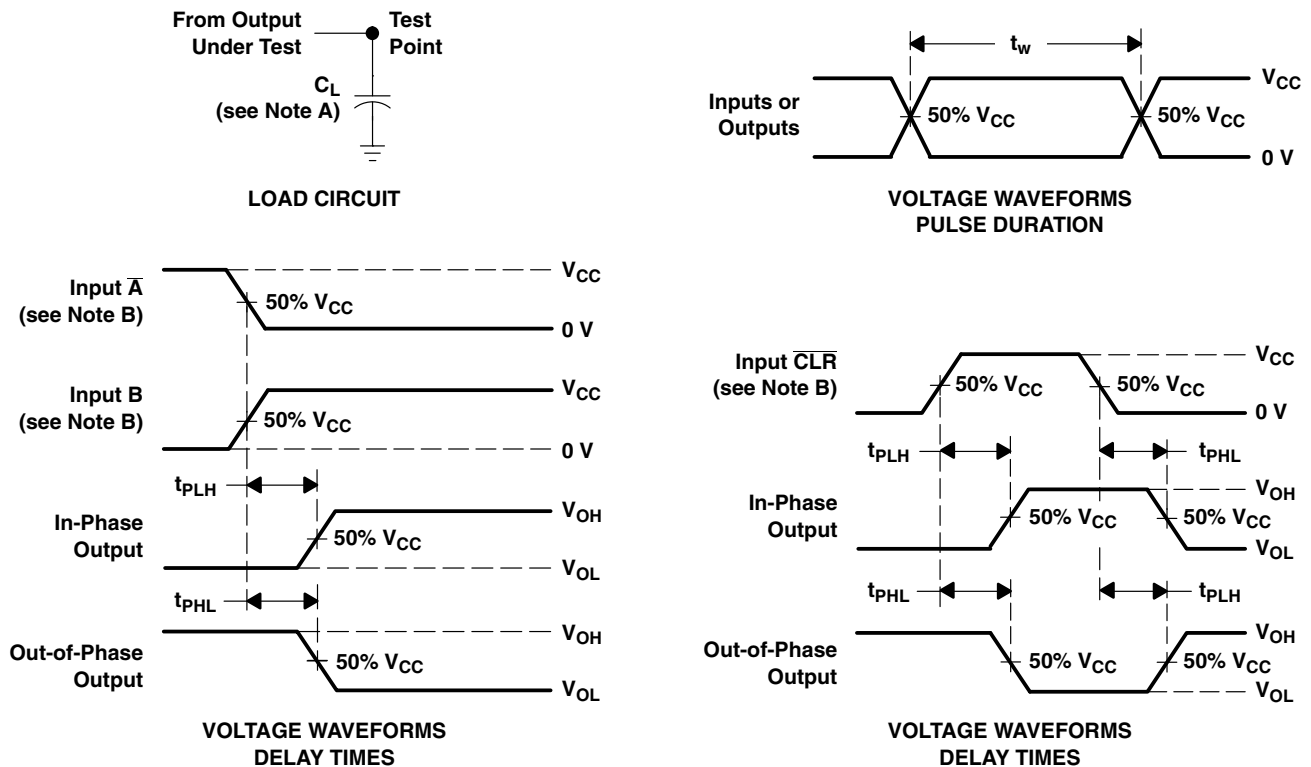

- NOTES: A. C_L includes probe and jig capacitance.
 B. All input pulses are supplied by generators having the following characteristics: $PRR \leq 1\text{ MHz}$, $Z_O = 50\ \Omega$, $t_r = 3\text{ ns}$, $t_f = 3\text{ ns}$.
 C. The outputs are measured one at a time, with one input transition per measurement.

Figure 1. Load Circuit and Voltage Waveforms

SN54LV123A, SN74LV123A DUAL RETRIGGERABLE MONOSTABLE MULTIVIBRATORS WITH SCHMITT-TRIGGER INPUTS

SCLS3930 – APRIL 1998 – REVISED OCTOBER 2005

APPLICATION INFORMATION†

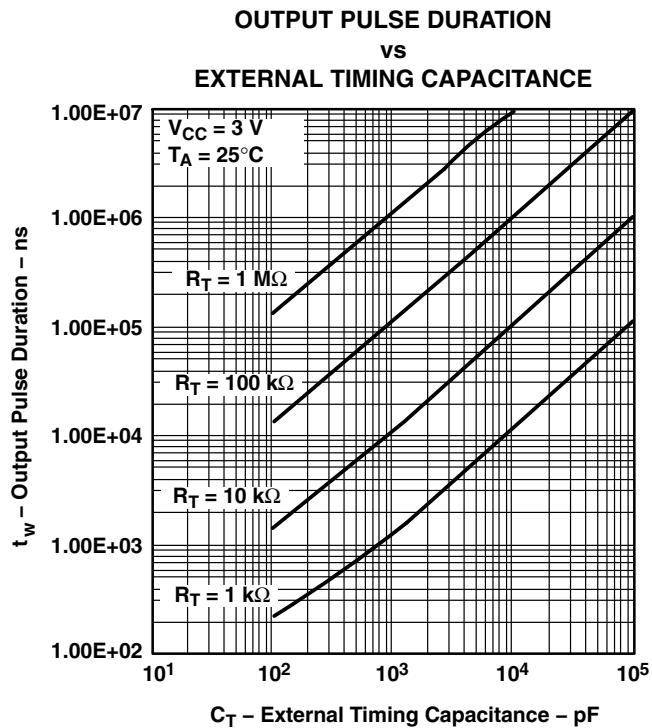

Figure 2

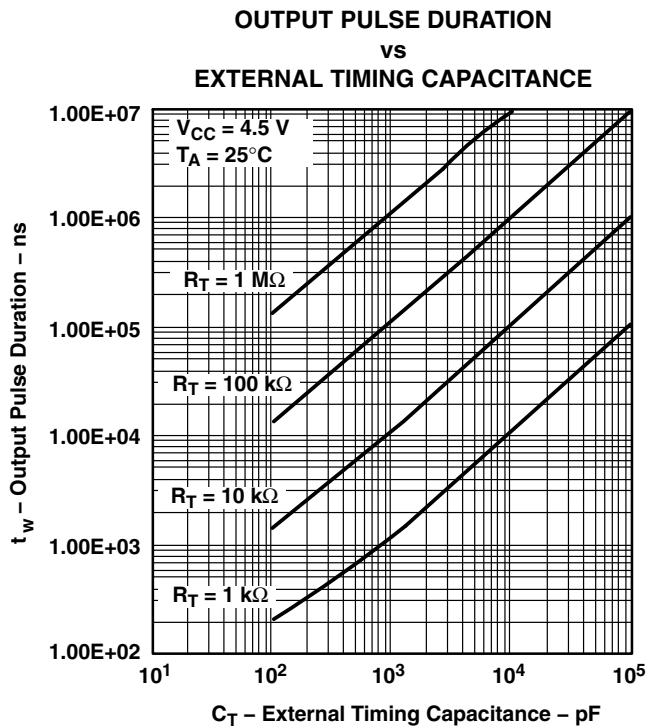

Figure 3

† Operation of the device at these or any other conditions beyond those indicated under "recommended operating conditions" is not implied.

SN54LV123A, SN74LV123A DUAL RETRIGGERABLE MONOSTABLE MULTIVIBRATORS WITH SCHMITT-TRIGGER INPUTS

SCLS3930 – APRIL 1998 – REVISED OCTOBER 2005

APPLICATION INFORMATION†

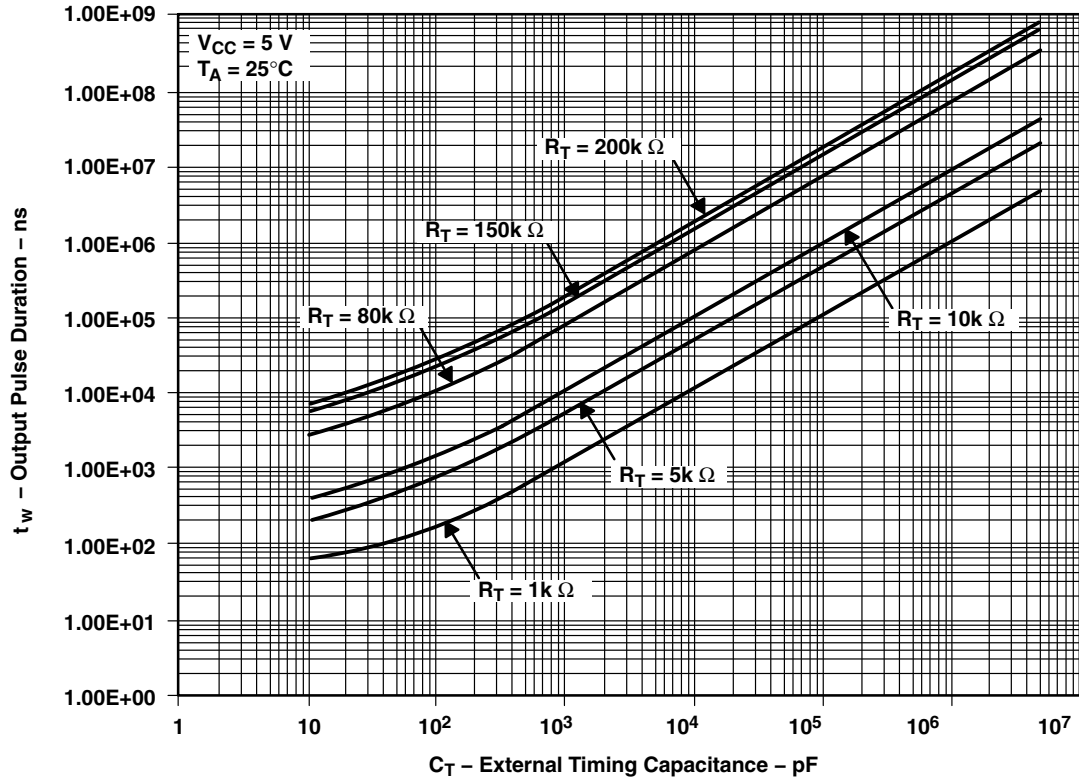

Figure 4. Output Pulse Duration vs External Timing Capacitance

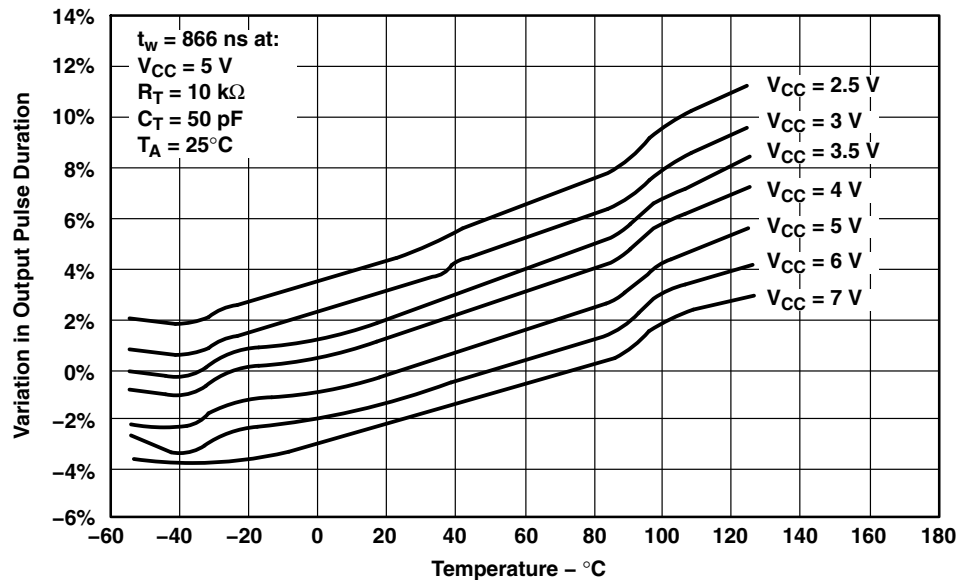

Figure 5. Variations in Output Pulse Duration vs Temperature

† Operation of the device at these or any other conditions beyond those indicated under "recommended operating conditions" is not implied.

SN54LV123A, SN74LV123A DUAL RETRIGGERABLE MONOSTABLE MULTIVIBRATORS WITH SCHMITT-TRIGGER INPUTS

SCLS393O – APRIL 1998 – REVISED OCTOBER 2005

APPLICATION INFORMATION†

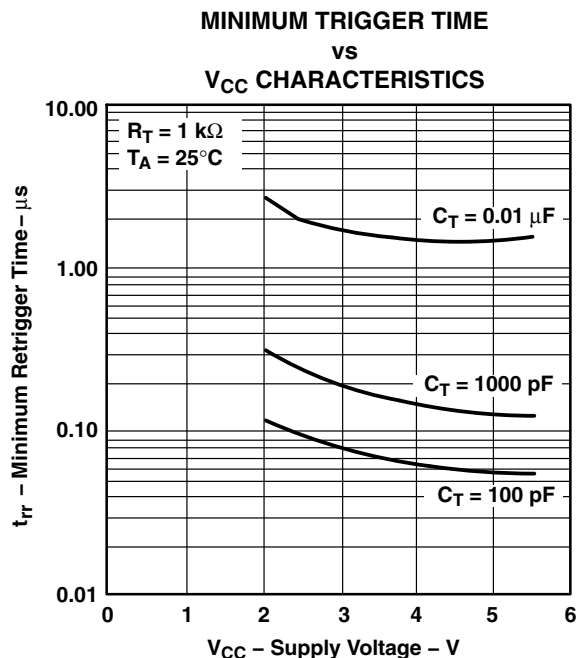

Figure 6

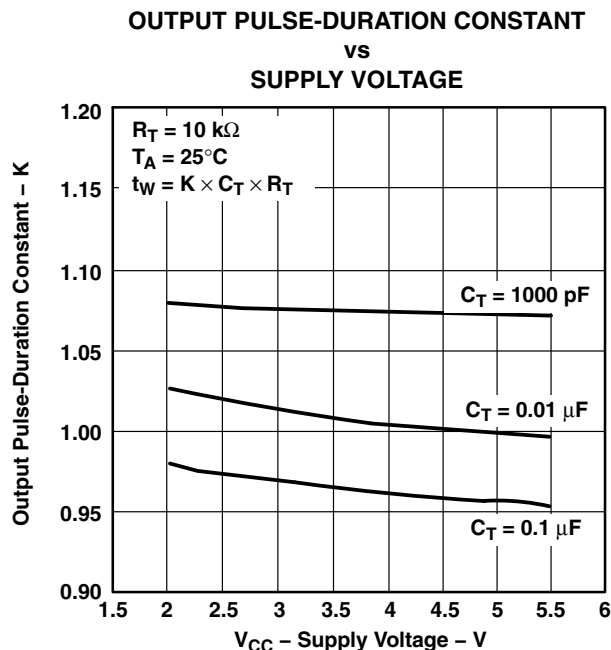

Figure 7

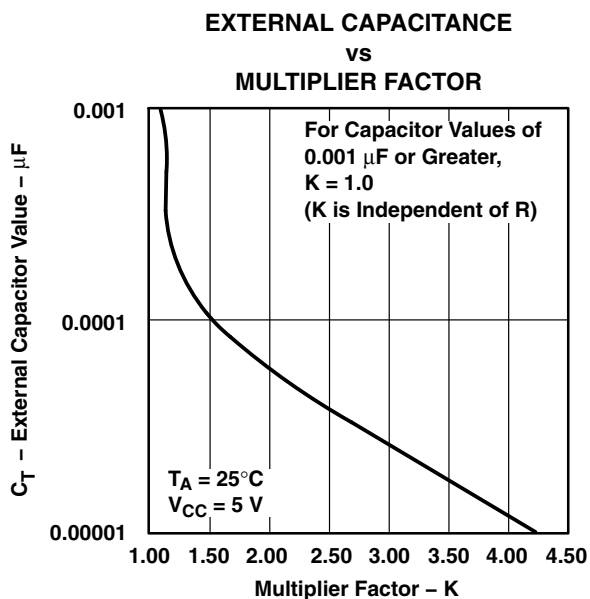

Figure 8

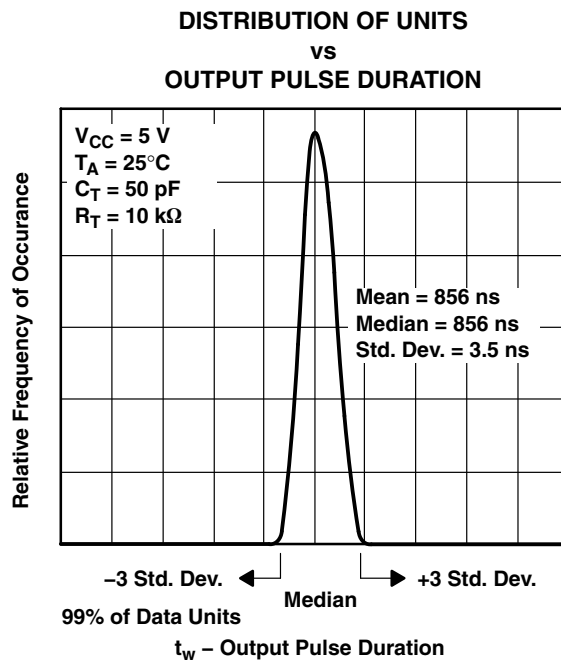

Figure 9

† Operation of the device at these or any other conditions beyond those indicated under "recommended operating conditions" is not implied.

APPLICATION INFORMATION

caution in use

To prevent malfunctions due to noise, connect a high-frequency capacitor between V_{CC} and GND, and keep the wiring between the external components and C_{ext} and R_{ext}/C_{ext} terminals as short as possible.

power-down considerations

Large values of C_{ext} can cause problems when powering down the 'LV123A devices because of the amount of energy stored in the capacitor. When a system containing this device is powered down, the capacitor can discharge from V_{CC} through the protection diodes at pin 2 or pin 14. Current through the input protection diodes must be limited to 30 mA; therefore, the turn-off time of the V_{CC} power supply must not be faster than $t = V_{CC} \times C_{ext}/30 \text{ mA}$. For example, if $V_{CC} = 5 \text{ V}$ and $C_{ext} = 15 \text{ pF}$, the V_{CC} supply must turn off no faster than $t = (5 \text{ V}) \times (15 \text{ pF})/30 \text{ mA} = 2.5 \text{ ns}$. Usually, this is not a problem because power supplies are heavily filtered and cannot discharge at this rate. When a more rapid decrease of V_{CC} to zero occurs, the 'LV123A devices can sustain damage. To avoid this possibility, use external clamping diodes.

output pulse duration

The output pulse duration, t_w , is determined primarily by the values of the external capacitance (C_T) and timing resistance (R_T). The timing components are connected as shown in Figure 10.

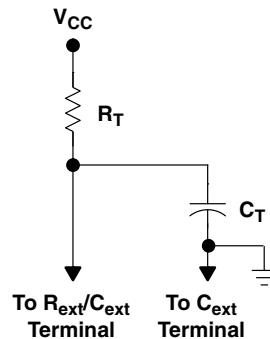

Figure 10. Timing-Component Connections

The pulse duration is given by:

$$t_w = K \times R_T \times C_T \tag{1}$$

if C_T is $\geq 1000 \text{ pF}$, $K = 1.0$ or
 if C_T is $< 1000 \text{ pF}$, K can be determined from Figure 8

where:

- t_w = pulse duration in ns
- R_T = external timing resistance in $k\Omega$
- C_T = external capacitance in pF
- K = multiplier factor

Equation 1 and Figure 3 can be used to determine values for pulse duration, external resistance, and external capacitance.

SN54LV123A, SN74LV123A DUAL RETRIGGERABLE MONOSTABLE MULTIVIBRATORS WITH SCHMITT-TRIGGER INPUTS

SCLS3930 – APRIL 1998 – REVISED OCTOBER 2005

APPLICATION INFORMATION

retriggering data

The minimum input retriggering time (t_{MIR}) is the minimum time required after the initial signal before retriggering the input. After t_{MIR} , the device retriggers the output. Experimentally, it also can be shown that to retrigger the output pulse, the two adjacent input signals should be t_{MIR} apart, where $t_{MIR} = 0.30 \times t_w$. The retrigger pulse duration is calculated as shown in Figure 11.

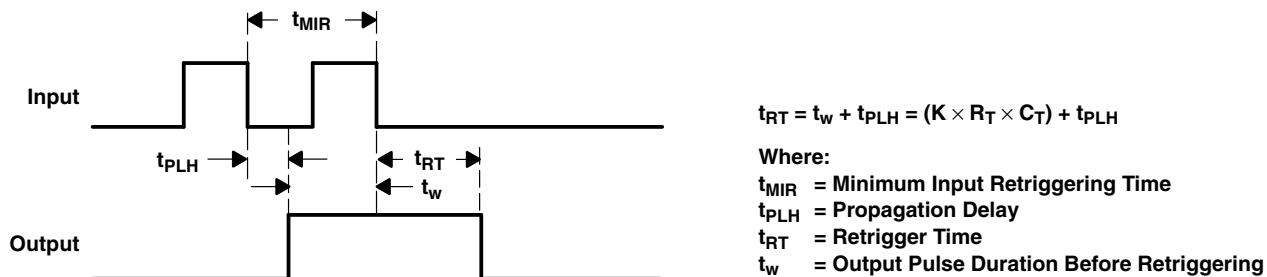

Figure 11. Retrigger Pulse Duration

The minimum value from the end of the input pulse to the beginning of the retriggered output should be approximately 15 ns to ensure a retriggered output (see Figure 12).

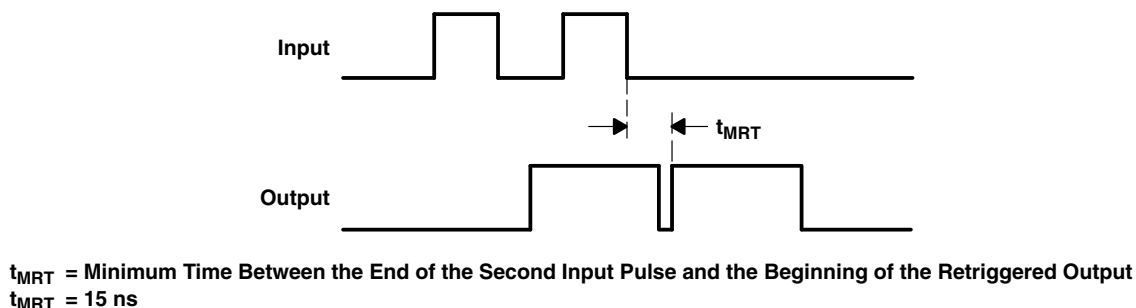

Figure 12. Input/Output Requirements

PACKAGING INFORMATION

Orderable Device	Status (1)	Package Type	Package Drawing	Pins	Package Qty	Eco Plan (2)	Lead/Ball Finish	MSL Peak Temp (3)	Op Temp (°C)	Top-Side Markings (4)	Samples
SN74LV123AD	ACTIVE	SOIC	D	16	40	Green (RoHS & no Sb/Br)	CU NIPDAU	Level-1-260C-UNLIM	-40 to 85	LV123A	Samples
SN74LV123ADBR	ACTIVE	SSOP	DB	16	2000	Green (RoHS & no Sb/Br)	CU NIPDAU	Level-1-260C-UNLIM	-40 to 85	LV123A	Samples
SN74LV123ADBRE4	ACTIVE	SSOP	DB	16	2000	Green (RoHS & no Sb/Br)	CU NIPDAU	Level-1-260C-UNLIM	-40 to 85	LV123A	Samples
SN74LV123ADBRG4	ACTIVE	SSOP	DB	16	2000	Green (RoHS & no Sb/Br)	CU NIPDAU	Level-1-260C-UNLIM	-40 to 85	LV123A	Samples
SN74LV123ADE4	ACTIVE	SOIC	D	16	40	Green (RoHS & no Sb/Br)	CU NIPDAU	Level-1-260C-UNLIM	-40 to 85	LV123A	Samples
SN74LV123ADG4	ACTIVE	SOIC	D	16	40	Green (RoHS & no Sb/Br)	CU NIPDAU	Level-1-260C-UNLIM	-40 to 85	LV123A	Samples
SN74LV123ADGVR	ACTIVE	TVSOP	DGV	16	2000	Green (RoHS & no Sb/Br)	CU NIPDAU	Level-1-260C-UNLIM	-40 to 85	LV123A	Samples
SN74LV123ADGVRE4	ACTIVE	TVSOP	DGV	16	2000	Green (RoHS & no Sb/Br)	CU NIPDAU	Level-1-260C-UNLIM	-40 to 85	LV123A	Samples
SN74LV123ADGVRG4	ACTIVE	TVSOP	DGV	16	2000	Green (RoHS & no Sb/Br)	CU NIPDAU	Level-1-260C-UNLIM	-40 to 85	LV123A	Samples
SN74LV123ADR	ACTIVE	SOIC	D	16	2500	Green (RoHS & no Sb/Br)	CU NIPDAU	Level-1-260C-UNLIM	-40 to 85	LV123A	Samples
SN74LV123ADRE4	ACTIVE	SOIC	D	16	2500	Green (RoHS & no Sb/Br)	CU NIPDAU	Level-1-260C-UNLIM	-40 to 85	LV123A	Samples
SN74LV123ADRG4	ACTIVE	SOIC	D	16	2500	Green (RoHS & no Sb/Br)	CU NIPDAU	Level-1-260C-UNLIM	-40 to 85	LV123A	Samples
SN74LV123ANSR	ACTIVE	SO	NS	16	2000	Green (RoHS & no Sb/Br)	CU NIPDAU	Level-1-260C-UNLIM	-40 to 85	74LV123A	Samples
SN74LV123ANSRE4	ACTIVE	SO	NS	16	2000	Green (RoHS & no Sb/Br)	CU NIPDAU	Level-1-260C-UNLIM	-40 to 85	74LV123A	Samples
SN74LV123ANSRG4	ACTIVE	SO	NS	16	2000	Green (RoHS & no Sb/Br)	CU NIPDAU	Level-1-260C-UNLIM	-40 to 85	74LV123A	Samples
SN74LV123APW	ACTIVE	TSSOP	PW	16	90	Green (RoHS & no Sb/Br)	CU NIPDAU	Level-1-260C-UNLIM	-40 to 85	LV123A	Samples
SN74LV123APWE4	ACTIVE	TSSOP	PW	16	90	Green (RoHS & no Sb/Br)	CU NIPDAU	Level-1-260C-UNLIM	-40 to 85	LV123A	Samples

Orderable Device	Status (1)	Package Type	Package Drawing	Pins	Package Qty	Eco Plan (2)	Lead/Ball Finish	MSL Peak Temp (3)	Op Temp (°C)	Top-Side Markings (4)	Samples
SN74LV123APWG4	ACTIVE	TSSOP	PW	16	90	Green (RoHS & no Sb/Br)	CU NIPDAU	Level-1-260C-UNLIM	-40 to 85	LV123A	Samples
SN74LV123APWR	ACTIVE	TSSOP	PW	16	2000	Green (RoHS & no Sb/Br)	CU NIPDAU	Level-1-260C-UNLIM	-40 to 85	LV123A	Samples
SN74LV123APWRE4	ACTIVE	TSSOP	PW	16	2000	Green (RoHS & no Sb/Br)	CU NIPDAU	Level-1-260C-UNLIM	-40 to 85	LV123A	Samples
SN74LV123APWRG4	ACTIVE	TSSOP	PW	16	2000	Green (RoHS & no Sb/Br)	CU NIPDAU	Level-1-260C-UNLIM	-40 to 85	LV123A	Samples
SN74LV123APWT	ACTIVE	TSSOP	PW	16	250	Green (RoHS & no Sb/Br)	CU NIPDAU	Level-1-260C-UNLIM	-40 to 85	LV123A	Samples
SN74LV123APWTE4	ACTIVE	TSSOP	PW	16	250	Green (RoHS & no Sb/Br)	CU NIPDAU	Level-1-260C-UNLIM	-40 to 85	LV123A	Samples
SN74LV123APWTG4	ACTIVE	TSSOP	PW	16	250	Green (RoHS & no Sb/Br)	CU NIPDAU	Level-1-260C-UNLIM	-40 to 85	LV123A	Samples
SN74LV123ARGYR	ACTIVE	VQFN	RGY	16	3000	Green (RoHS & no Sb/Br)	CU NIPDAU	Level-2-260C-1 YEAR	-40 to 85	LV123A	Samples
SN74LV123ARGYRG4	ACTIVE	VQFN	RGY	16	3000	Green (RoHS & no Sb/Br)	CU NIPDAU	Level-2-260C-1 YEAR	-40 to 85	LV123A	Samples

(1) The marketing status values are defined as follows:

ACTIVE: Product device recommended for new designs.

LIFEBUY: TI has announced that the device will be discontinued, and a lifetime-buy period is in effect.

NRND: Not recommended for new designs. Device is in production to support existing customers, but TI does not recommend using this part in a new design.

PREVIEW: Device has been announced but is not in production. Samples may or may not be available.

OBSELETE: TI has discontinued the production of the device.

(2) Eco Plan - The planned eco-friendly classification: Pb-Free (RoHS), Pb-Free (RoHS Exempt), or Green (RoHS & no Sb/Br) - please check <http://www.ti.com/productcontent> for the latest availability information and additional product content details.

TBD: The Pb-Free/Green conversion plan has not been defined.

Pb-Free (RoHS): TI's terms "Lead-Free" or "Pb-Free" mean semiconductor products that are compatible with the current RoHS requirements for all 6 substances, including the requirement that lead not exceed 0.1% by weight in homogeneous materials. Where designed to be soldered at high temperatures, TI Pb-Free products are suitable for use in specified lead-free processes.

Pb-Free (RoHS Exempt): This component has a RoHS exemption for either 1) lead-based flip-chip solder bumps used between the die and package, or 2) lead-based die adhesive used between the die and leadframe. The component is otherwise considered Pb-Free (RoHS compatible) as defined above.

Green (RoHS & no Sb/Br): TI defines "Green" to mean Pb-Free (RoHS compatible), and free of Bromine (Br) and Antimony (Sb) based flame retardants (Br or Sb do not exceed 0.1% by weight in homogeneous material)

(3) MSL, Peak Temp. -- The Moisture Sensitivity Level rating according to the JEDEC industry standard classifications, and peak solder temperature.

(4) Multiple Top-Side Markings will be inside parentheses. Only one Top-Side Marking contained in parentheses and separated by a "~" will appear on a device. If a line is indented then it is a continuation of the previous line and the two combined represent the entire Top-Side Marking for that device.

Important Information and Disclaimer:The information provided on this page represents TI's knowledge and belief as of the date that it is provided. TI bases its knowledge and belief on information provided by third parties, and makes no representation or warranty as to the accuracy of such information. Efforts are underway to better integrate information from third parties. TI has taken and continues to take reasonable steps to provide representative and accurate information but may not have conducted destructive testing or chemical analysis on incoming materials and chemicals. TI and TI suppliers consider certain information to be proprietary, and thus CAS numbers and other limited information may not be available for release.

In no event shall TI's liability arising out of such information exceed the total purchase price of the TI part(s) at issue in this document sold by TI to Customer on an annual basis.

OTHER QUALIFIED VERSIONS OF SN74LV123A :

- Automotive: [SN74LV123A-Q1](#)
- Enhanced Product: [SN74LV123A-EP](#)

NOTE: Qualified Version Definitions:

- Automotive - Q100 devices qualified for high-reliability automotive applications targeting zero defects
- Enhanced Product - Supports Defense, Aerospace and Medical Applications

TAPE AND REEL INFORMATION



QUADRANT ASSIGNMENTS FOR PIN 1 ORIENTATION IN TAPE



*All dimensions are nominal

Device	Package Type	Package Drawing	Pins	SPQ	Reel Diameter (mm)	Reel Width W1 (mm)	A0 (mm)	B0 (mm)	K0 (mm)	P1 (mm)	W (mm)	Pin1 Quadrant
SN74LV123ADBR	SSOP	DB	16	2000	330.0	16.4	8.2	6.6	2.5	12.0	16.0	Q1
SN74LV123ADGVR	TVSOP	DGV	16	2000	330.0	12.4	6.8	4.0	1.6	8.0	12.0	Q1
SN74LV123ADRG4	SOIC	D	16	2500	330.0	16.4	6.5	10.3	2.1	8.0	16.0	Q1
SN74LV123APWR	TSSOP	PW	16	2000	330.0	12.4	7.0	5.6	1.6	8.0	12.0	Q1
SN74LV123APWR	TSSOP	PW	16	2000	330.0	12.4	6.9	5.6	1.6	8.0	12.0	Q1
SN74LV123APWRG4	TSSOP	PW	16	2000	330.0	12.4	6.9	5.6	1.6	8.0	12.0	Q1
SN74LV123APWT	TSSOP	PW	16	250	330.0	12.4	6.9	5.6	1.6	8.0	12.0	Q1
SN74LV123ARGYR	VQFN	RGY	16	3000	330.0	12.4	3.8	4.3	1.5	8.0	12.0	Q1

TAPE AND REEL BOX DIMENSIONS

*All dimensions are nominal

Device	Package Type	Package Drawing	Pins	SPQ	Length (mm)	Width (mm)	Height (mm)
SN74LV123ADBR	SSOP	DB	16	2000	367.0	367.0	38.0
SN74LV123ADGVR	TVSOP	DGV	16	2000	367.0	367.0	35.0
SN74LV123ADRG4	SOIC	D	16	2500	333.2	345.9	28.6
SN74LV123APWR	TSSOP	PW	16	2000	364.0	364.0	27.0
SN74LV123APWR	TSSOP	PW	16	2000	367.0	367.0	35.0
SN74LV123APWRG4	TSSOP	PW	16	2000	367.0	367.0	35.0
SN74LV123APWT	TSSOP	PW	16	250	367.0	367.0	35.0
SN74LV123ARGYR	VQFN	RGY	16	3000	367.0	367.0	35.0

D (R-PDSO-G16)

PLASTIC SMALL OUTLINE



- NOTES:
- All linear dimensions are in millimeters.
 - This drawing is subject to change without notice.
 - Publication IPC-7351 is recommended for alternate designs.
 - Laser cutting apertures with trapezoidal walls and also rounding corners will offer better paste release. Customers should contact their board assembly site for stencil design recommendations. Refer to IPC-7525 for other stencil recommendations.
 - Customers should contact their board fabrication site for solder mask tolerances between and around signal pads.

PW (R-PDSO-G16)

PLASTIC SMALL OUTLINE



4040064-4/G 02/11

- NOTES:
- A. All linear dimensions are in millimeters. Dimensioning and tolerancing per ASME Y14.5M-1994.
 - B. This drawing is subject to change without notice.
 -  Body length does not include mold flash, protrusions, or gate burrs. Mold flash, protrusions, or gate burrs shall not exceed 0,15 each side.
 -  Body width does not include interlead flash. Interlead flash shall not exceed 0,25 each side.
 - E. Falls within JEDEC MO-153

PW (R-PDSO-G16)

PLASTIC SMALL OUTLINE

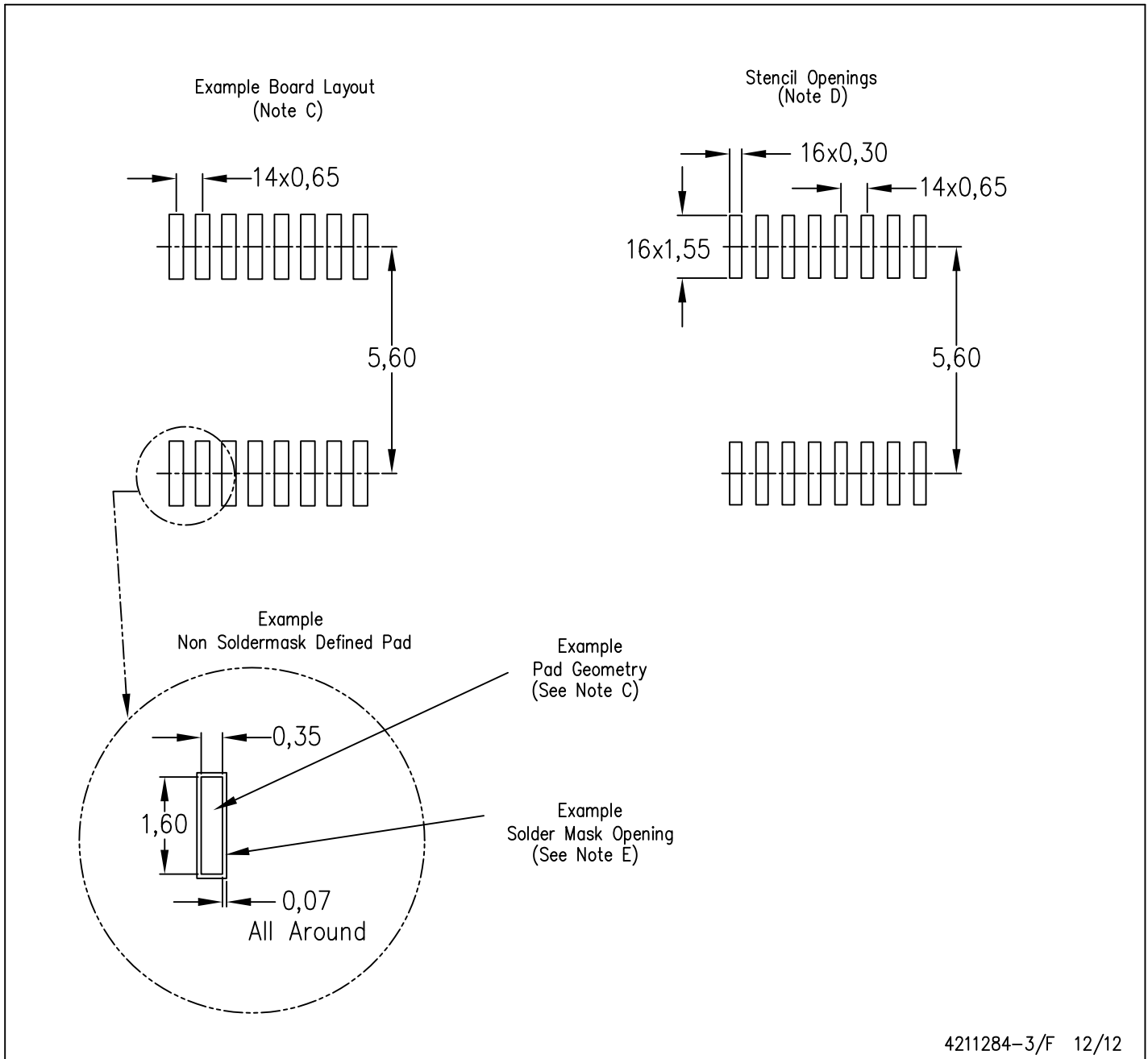

- NOTES:
- All linear dimensions are in millimeters.
 - This drawing is subject to change without notice.
 - Publication IPC-7351 is recommended for alternate designs.
 - Laser cutting apertures with trapezoidal walls and also rounding corners will offer better paste release. Customers should contact their board assembly site for stencil design recommendations. Refer to IPC-7525 for other stencil recommendations.
 - Customers should contact their board fabrication site for solder mask tolerances between and around signal pads.

RGY (R-PVQFN-N16)

PLASTIC QUAD FLATPACK NO-LEAD

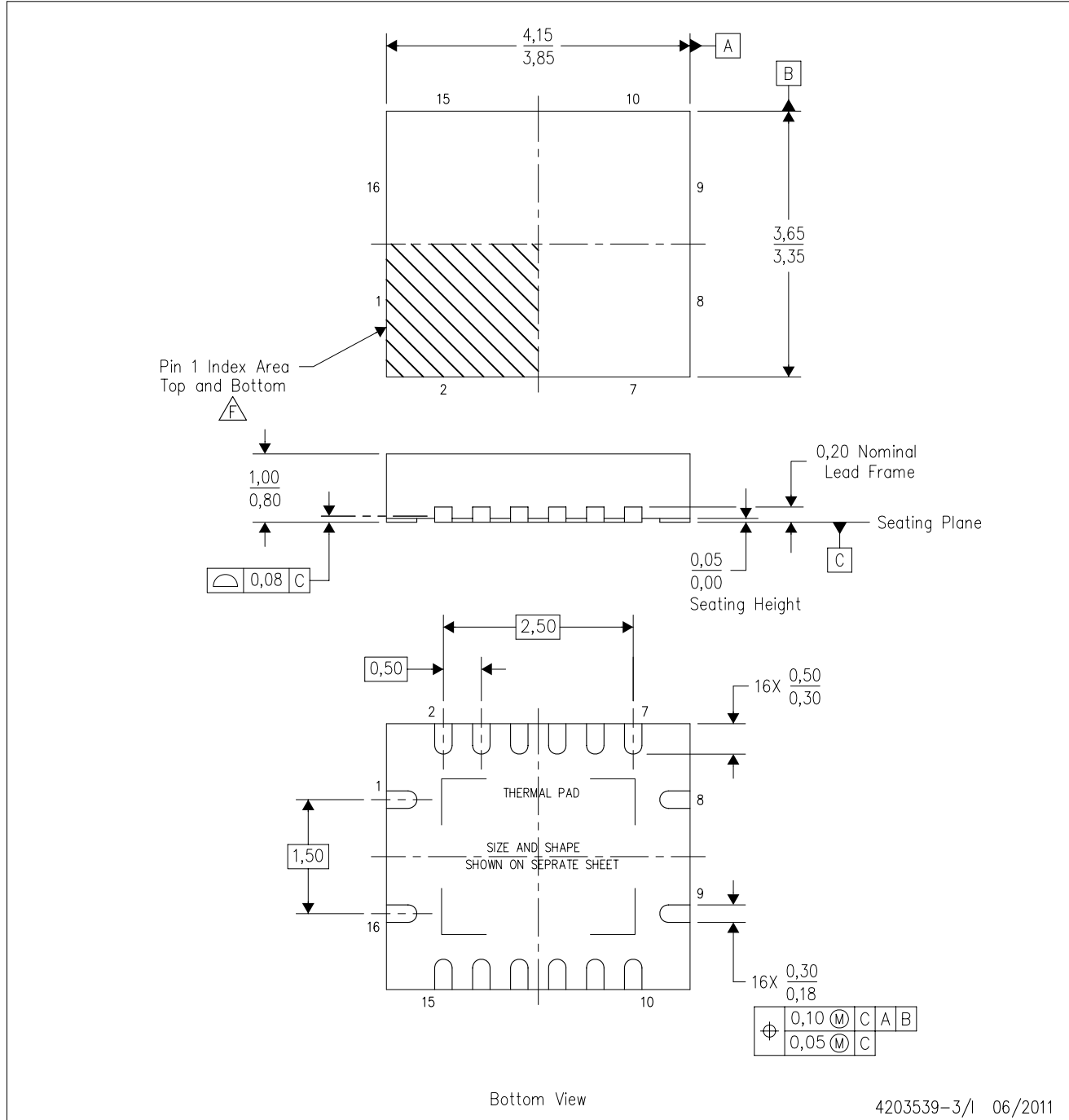

- NOTES:
- A. All linear dimensions are in millimeters. Dimensioning and tolerancing per ASME Y14.5M-1994.
 - B. This drawing is subject to change without notice.
 - C. QFN (Quad Flatpack No-Lead) package configuration.
 - D. The package thermal pad must be soldered to the board for thermal and mechanical performance.
 - E. See the additional figure in the Product Data Sheet for details regarding the exposed thermal pad features and dimensions.
 - F. Pin 1 identifiers are located on both top and bottom of the package and within the zone indicated. The Pin 1 identifiers are either a molded, marked, or metal feature.
 - G. Package complies to JEDEC MO-241 variation BA.

RGY (R-PVQFN-N16)

PLASTIC QUAD FLATPACK NO-LEAD

THERMAL INFORMATION

This package incorporates an exposed thermal pad that is designed to be attached directly to an external heatsink. The thermal pad must be soldered directly to the printed circuit board (PCB). After soldering, the PCB can be used as a heatsink. In addition, through the use of thermal vias, the thermal pad can be attached directly to the appropriate copper plane shown in the electrical schematic for the device, or alternatively, can be attached to a special heatsink structure designed into the PCB. This design optimizes the heat transfer from the integrated circuit (IC).

For information on the Quad Flatpack No-Lead (QFN) package and its advantages, refer to Application Report, QFN/SON PCB Attachment, Texas Instruments Literature No. SLUA271. This document is available at www.ti.com.

The exposed thermal pad dimensions for this package are shown in the following illustration.

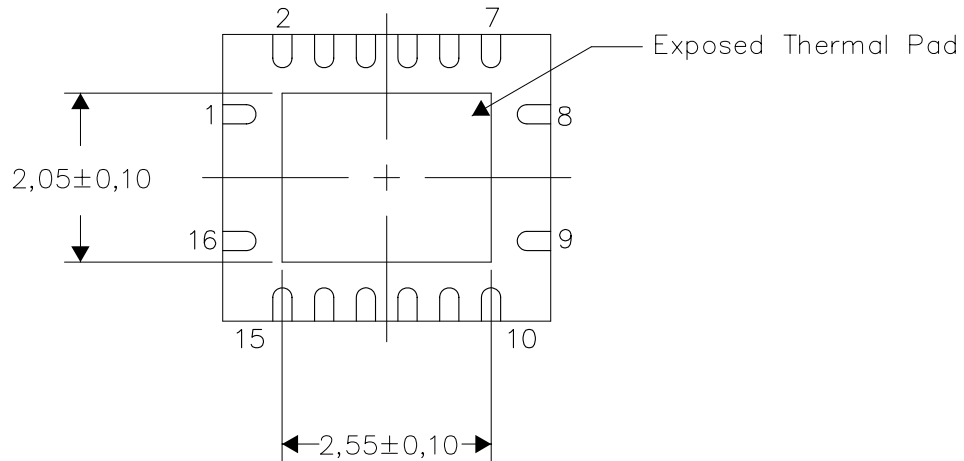

Bottom View

Exposed Thermal Pad Dimensions

4206353-3/0 11/11

NOTE: All linear dimensions are in millimeters

RGY (R-PVQFN-N16)

PLASTIC QUAD FLATPACK NO-LEAD

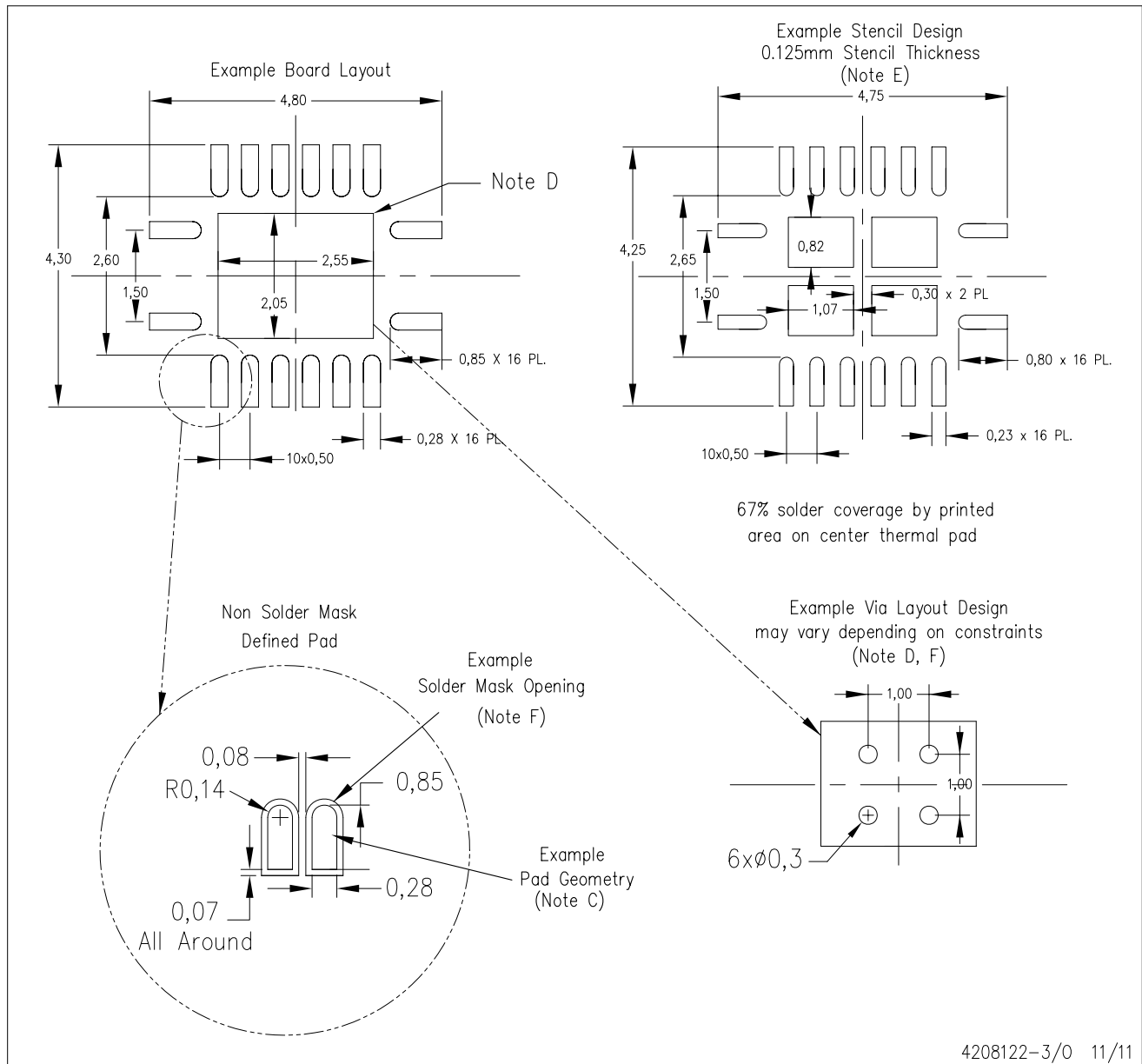

- NOTES:
- A. All linear dimensions are in millimeters.
 - B. This drawing is subject to change without notice.
 - C. Publication IPC-7351 is recommended for alternate designs.
 - D. This package is designed to be soldered to a thermal pad on the board. Refer to Application Note, Quad Flat-Pack QFN/SON PCB Attachment, Texas Instruments Literature No. SLUA271, and also the Product Data Sheets for specific thermal information, via requirements, and recommended board layout. These documents are available at www.ti.com <<http://www.ti.com>>.
 - E. Laser cutting apertures with trapezoidal walls and also rounding corners will offer better paste release. Customers should contact their board assembly site for stencil design recommendations. Refer to IPC 7525 for stencil design considerations.
 - F. Customers should contact their board fabrication site for minimum solder mask web tolerances between signal pads.

MECHANICAL DATA

NS (R-PDSO-G**)

PLASTIC SMALL-OUTLINE PACKAGE

14-PINS SHOWN

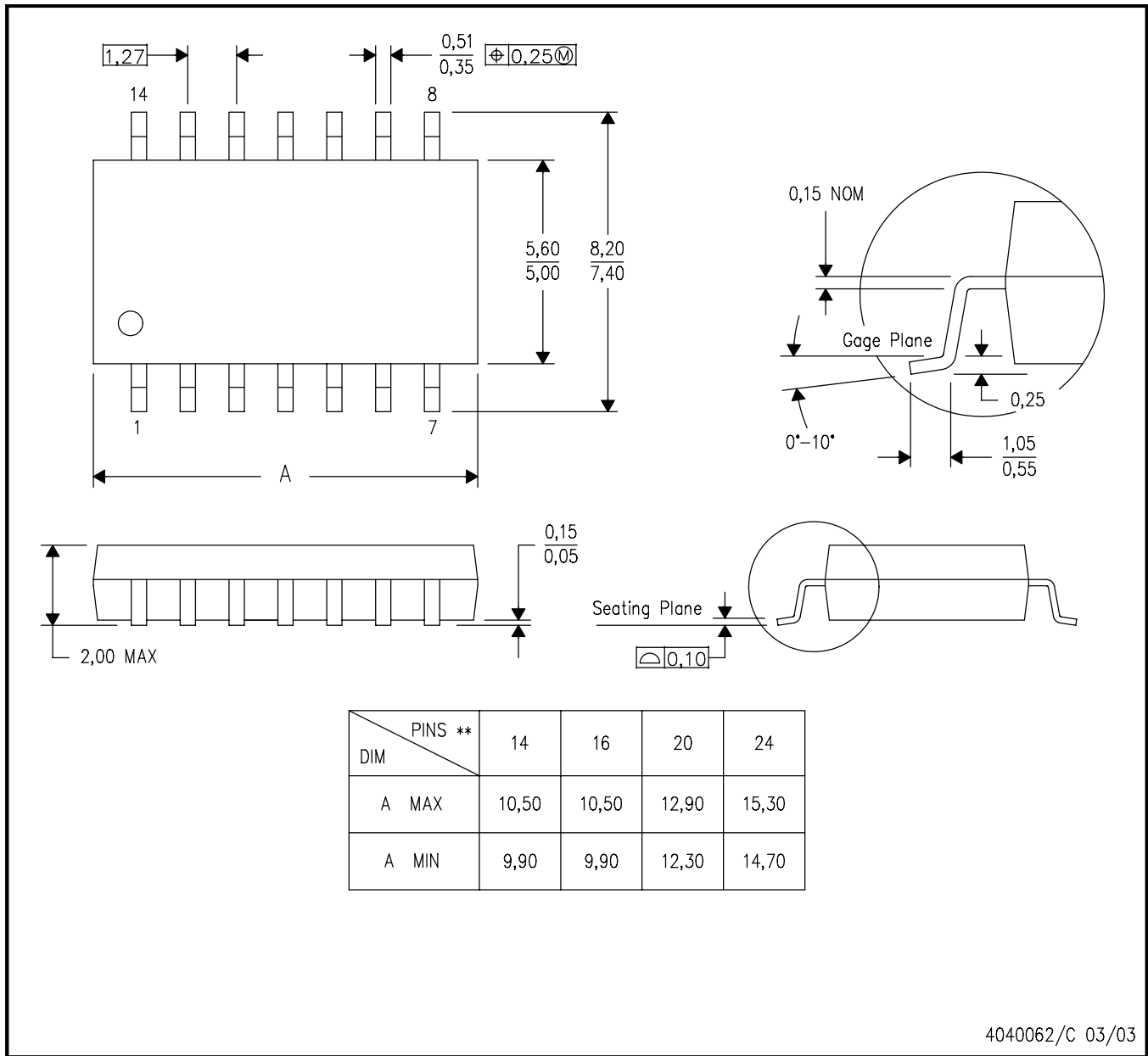

- NOTES:
- A. All linear dimensions are in millimeters.
 - B. This drawing is subject to change without notice.
 - C. Body dimensions do not include mold flash or protrusion, not to exceed 0,15.

DB (R-PDSO-G**)

PLASTIC SMALL-OUTLINE

28 PINS SHOWN



- NOTES: A. All linear dimensions are in millimeters.
 B. This drawing is subject to change without notice.
 C. Body dimensions do not include mold flash or protrusion not to exceed 0,15.
 D. Falls within JEDEC MO-150

IMPORTANT NOTICE

Texas Instruments Incorporated and its subsidiaries (TI) reserve the right to make corrections, enhancements, improvements and other changes to its semiconductor products and services per JESD46, latest issue, and to discontinue any product or service per JESD48, latest issue. Buyers should obtain the latest relevant information before placing orders and should verify that such information is current and complete. All semiconductor products (also referred to herein as "components") are sold subject to TI's terms and conditions of sale supplied at the time of order acknowledgment.

TI warrants performance of its components to the specifications applicable at the time of sale, in accordance with the warranty in TI's terms and conditions of sale of semiconductor products. Testing and other quality control techniques are used to the extent TI deems necessary to support this warranty. Except where mandated by applicable law, testing of all parameters of each component is not necessarily performed.

TI assumes no liability for applications assistance or the design of Buyers' products. Buyers are responsible for their products and applications using TI components. To minimize the risks associated with Buyers' products and applications, Buyers should provide adequate design and operating safeguards.

TI does not warrant or represent that any license, either express or implied, is granted under any patent right, copyright, mask work right, or other intellectual property right relating to any combination, machine, or process in which TI components or services are used. Information published by TI regarding third-party products or services does not constitute a license to use such products or services or a warranty or endorsement thereof. Use of such information may require a license from a third party under the patents or other intellectual property of the third party, or a license from TI under the patents or other intellectual property of TI.

Reproduction of significant portions of TI information in TI data books or data sheets is permissible only if reproduction is without alteration and is accompanied by all associated warranties, conditions, limitations, and notices. TI is not responsible or liable for such altered documentation. Information of third parties may be subject to additional restrictions.

Resale of TI components or services with statements different from or beyond the parameters stated by TI for that component or service voids all express and any implied warranties for the associated TI component or service and is an unfair and deceptive business practice. TI is not responsible or liable for any such statements.

Buyer acknowledges and agrees that it is solely responsible for compliance with all legal, regulatory and safety-related requirements concerning its products, and any use of TI components in its applications, notwithstanding any applications-related information or support that may be provided by TI. Buyer represents and agrees that it has all the necessary expertise to create and implement safeguards which anticipate dangerous consequences of failures, monitor failures and their consequences, lessen the likelihood of failures that might cause harm and take appropriate remedial actions. Buyer will fully indemnify TI and its representatives against any damages arising out of the use of any TI components in safety-critical applications.

In some cases, TI components may be promoted specifically to facilitate safety-related applications. With such components, TI's goal is to help enable customers to design and create their own end-product solutions that meet applicable functional safety standards and requirements. Nonetheless, such components are subject to these terms.

No TI components are authorized for use in FDA Class III (or similar life-critical medical equipment) unless authorized officers of the parties have executed a special agreement specifically governing such use.

Only those TI components which TI has specifically designated as military grade or "enhanced plastic" are designed and intended for use in military/aerospace applications or environments. Buyer acknowledges and agrees that any military or aerospace use of TI components which have **not** been so designated is solely at the Buyer's risk, and that Buyer is solely responsible for compliance with all legal and regulatory requirements in connection with such use.

TI has specifically designated certain components as meeting ISO/TS16949 requirements, mainly for automotive use. In any case of use of non-designated products, TI will not be responsible for any failure to meet ISO/TS16949.

Products

Audio	www.ti.com/audio
Amplifiers	amplifier.ti.com
Data Converters	dataconverter.ti.com
DLP® Products	www.dlp.com
DSP	dsp.ti.com
Clocks and Timers	www.ti.com/clocks
Interface	interface.ti.com
Logic	logic.ti.com
Power Mgmt	power.ti.com
Microcontrollers	microcontroller.ti.com
RFID	www.ti-rfid.com
OMAP Applications Processors	www.ti.com/omap
Wireless Connectivity	www.ti.com/wirelessconnectivity

Applications

Automotive and Transportation	www.ti.com/automotive
Communications and Telecom	www.ti.com/communications
Computers and Peripherals	www.ti.com/computers
Consumer Electronics	www.ti.com/consumer-apps
Energy and Lighting	www.ti.com/energy
Industrial	www.ti.com/industrial
Medical	www.ti.com/medical
Security	www.ti.com/security
Space, Avionics and Defense	www.ti.com/space-avionics-defense
Video and Imaging	www.ti.com/video

TI E2E Community

e2e.ti.com