

# TLV2460A-EP TLV2461A-EP TLV2462A-EP TLV2463A-EP TLV2464A-EP FAMILY OF LOW-POWER RAIL-TO-RAIL INPUT/OUTPUT OPERATIONAL AMPLIFIERS WITH SHUTDOWN

SGLS132C – AUGUST 2002 – REVISED OCTOBER 2005

- **Controlled Baseline**
  - One Assembly/Test Site, One Fabrication Site
- **Extended Temperature Performance of –55°C to 125°C**
- **Enhanced Diminishing Manufacturing Sources (DMS) Support**
- **Enhanced Product Change Notification**
- **Qualification Pedigree†**
- **Rail-to-Rail Output Swing**
- **Gain Bandwidth Product . . . 6.4 MHz**
- **±80 mA Output Drive Capability**
- **Supply Current . . . 500 µA/channel**
- **Input Offset Voltage . . . 100 µV**
- **Input Noise Voltage . . . 11 nV/√Hz**
- **Slew Rate . . . 1.6 V/µs**
- **Micropower Shutdown Mode (TLV2460/3) . . . 0.3 µA/Channel**
- **Universal Operational Amplifier EVM**

† Component qualification in accordance with JEDEC and industry standards to ensure reliable operation over an extended temperature range. This includes, but is not limited to, Highly Accelerated Stress Test (HAST) or biased 85/85, temperature cycle, autoclave or unbiased HAST, electromigration, bond intermetallic life, and mold compound life. Such qualification testing should not be viewed as justifying use of this component beyond specified performance and environmental limits.

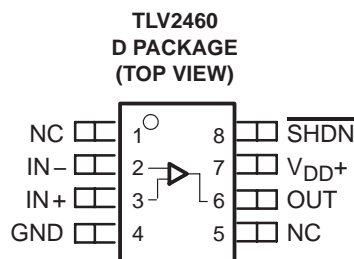

## description

The TLV246x is a family of low-power rail-to-rail input/output operational amplifiers specifically designed for portable applications. The input common-mode voltage range extends beyond the supply rails for maximum dynamic range in low-voltage systems. The amplifier output has rail-to-rail performance with high-output-drive capability, solving one of the limitations of older rail-to-rail input/output operational amplifiers. This rail-to-rail dynamic range and high output drive make the TLV246x ideal for buffering analog-to-digital converters.

The operational amplifier has 6.4 MHz of bandwidth and 1.6 V/µs of slew rate with only 500 µA of supply current, providing good ac performance with low power consumption. Devices are available with an optional shutdown terminal, which places the amplifier in an ultralow supply current mode ( $I_{DD} = 0.3 \mu\text{A}/\text{ch}$ ). While in shutdown, the operational-amplifier output is placed in a high-impedance state. DC applications are also well served with an input noise voltage of 11 nV/√Hz and input offset voltage of 100 µV.

## ORDERING INFORMATION†

TA	PACKAGE‡		ORDERABLE PART NUMBER	TOP-SIDE MARKING
–40°C to 125°C	D	Tape and reel	TLV2462AQDREP	2462AE
	D	Tape and reel	TLV2463AQDREP	V2463AQE
–55°C to 125°C	D	Tape and reel	TLV2462AMDREP	2462AM
	D	Tape and reel	TLV2464AMDREP	V2464AME
	PW	Tape and reel	TLV2464AMPWREP	2464AME

† Some of the TLV246x family, along with packaging options, are in the **Product Preview** stage of development. Contact the local Texas Instruments sales office for availability.

‡ Package drawings, standard packing quantities, thermal data, symbolization, and PCB design guidelines are available at [www.ti.com/sc/package](http://www.ti.com/sc/package).



Please be aware that an important notice concerning availability, standard warranty, and use in critical applications of Texas Instruments semiconductor products and disclaimers thereto appears at the end of this data sheet.

PRODUCTION DATA information is current as of publication date. Products conform to specifications per the terms of Texas Instruments standard warranty. Production processing does not necessarily include testing of all parameters.

 **TEXAS  
INSTRUMENTS**

POST OFFICE BOX 655303 • DALLAS, TEXAS 75265

Copyright © 2005, Texas Instruments Incorporated

# TLV2460A-EP TLV2461A-EP TLV2462A-EP TLV2463A-EP TLV2464A-EP

## FAMILY OF LOW-POWER RAIL-TO-RAIL INPUT/OUTPUT OPERATIONAL AMPLIFIERS WITH SHUTDOWN

SGLS132C – AUGUST 2002 – REVISED OCTOBER 2005

### TLV246x PACKAGE PINOUTS

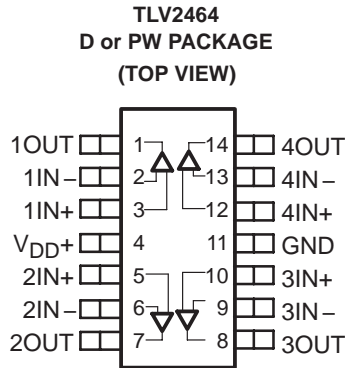
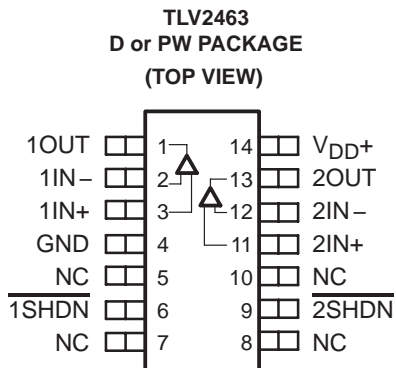
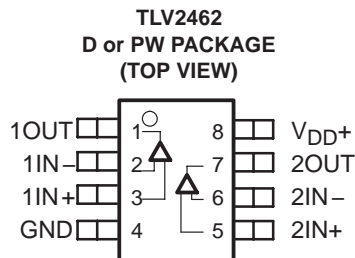
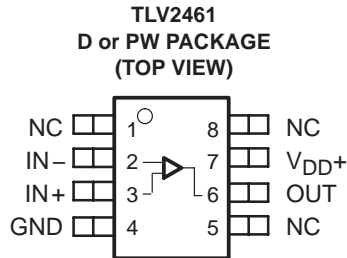

NC – No internal connection

# TLV2460A-EP TLV2461A-EP TLV2462A-EP TLV2463A-EP TLV2464A-EP FAMILY OF LOW-POWER RAIL-TO-RAIL INPUT/OUTPUT OPERATIONAL AMPLIFIERS WITH SHUTDOWN

SGLS132C – AUGUST 2002 – REVISED OCTOBER 2005

## absolute maximum ratings over operating free-air temperature range (unless otherwise noted)†

Supply voltage, $V_{DD}$ (see Note 1)	6 V
Differential input voltage, $V_{ID}$	- 0.2 V to $V_{DD} + 0.2$ V
Input current, $I_I$ (any input)	$\pm 200$ mA
Output current, $I_O$	$\pm 175$ mA
Total input current, $I_I$ (into $V_{DD+}$ )	175 mA
Total output current, $I_O$ (out of GND)	175 mA
Continuous total power dissipation	See Dissipation Rating Table
Operating free-air temperature range, $T_A$	-55°C to 125°C
Maximum junction temperature, $T_J$	150°C
Storage temperature range, $T_{stg}$	-65°C to 150°C
Lead temperature 1,6 mm (1/16 inch) from case for 10 seconds	260°C

† Stresses beyond those listed under “absolute maximum ratings” may cause permanent damage to the device. These are stress ratings only, and functional operation of the device at these or any other conditions beyond those indicated under “recommended operating conditions” is not implied. Exposure to absolute-maximum-rated conditions for extended periods may affect device reliability.

NOTE 1: All voltage values, except differential voltages, are with respect to GND.

**THERMAL RESISTANCE TABLE**

PACKAGE	$\theta_{JC}$ (°C/W)		$\theta_{JA}$ (°C/W, 0 Air Flow)	
	High K	Low K	High K	Low K
D (8)	39.4	42.4	97.1	165.5
D (14)	51.5	53.7	86.2	133.5
PW (8)	65.1	69.4	149.4	230.5
PW (14)	45.8	46.6	111.7	131.4

NOTE: Thermal resistances are not production tested and are for informational purposes only.

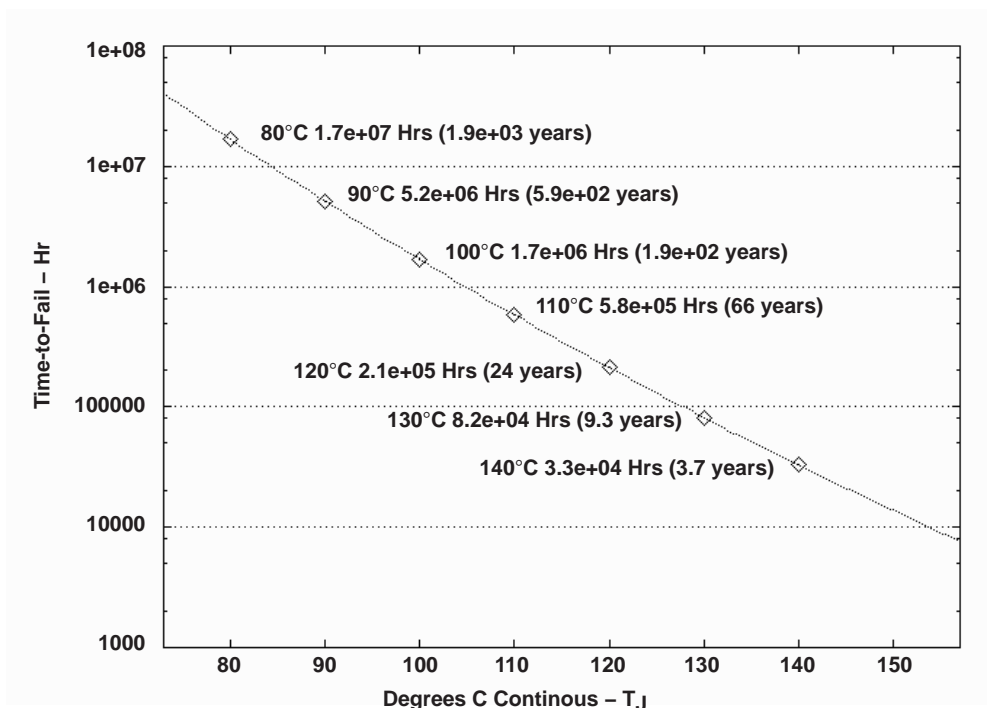

**Figure 1. Wirebond Life Estimation Plot**



**TLV2460A-EP TLV2461A-EP TLV2462A-EP TLV2463A-EP TLV2464A-EP**  
**FAMILY OF LOW-POWER RAIL-TO-RAIL INPUT/OUTPUT**  
**OPERATIONAL AMPLIFIERS WITH SHUTDOWN**

SGLS132C – AUGUST 2002 – REVISED OCTOBER 2005

**recommended operating conditions**

		MIN	MAX	UNIT
Supply voltage, $V_{DD}$	Single supply	2.7	6	V
	Split supply	$\pm 1.35$	$\pm 3$	
Common-mode input voltage range, $V_{ICR}$		-0.2	$V_{DD}+0.2$	V
Shutdown on/off voltage level <sup>†</sup>	$V_{IH}$	2		V
	$V_{IL}$		0.7	
Operating free-air temperature, $T_A$		-40	125	°C

<sup>†</sup> Relative to voltage on the GND terminal of the device.

**TLV2460A-EP TLV2461A-EP TLV2462A-EP TLV2463A-EP TLV2464A-EP**  
**FAMILY OF LOW-POWER RAIL-TO-RAIL INPUT/OUTPUT**  
**OPERATIONAL AMPLIFIERS WITH SHUTDOWN**

SGLS132C – AUGUST 2002 – REVISED OCTOBER 2005

**electrical characteristics at specified free-air temperature,  $V_{DD} = 3\text{ V}$  (unless otherwise noted)**

PARAMETER		TEST CONDITIONS	$T_A$ †	MIN	TYP	MAX	UNIT
$V_{IO}$	Input offset voltage	$V_{DD} = 3\text{ V}$ , $V_O = 1.5\text{ V}$ ,	$V_{IC} = 1.5\text{ V}$ , $R_S = 50\ \Omega$	25°C	150	1500	$\mu\text{V}$
				Full range		1700	
$\alpha_{VIO}$	Temperature coefficient of input offset voltage				2		$\mu\text{V}/^\circ\text{C}$
$I_{IO}$	Input offset current	$V_{DD} = 3\text{ V}$ , $V_O = 1.5\text{ V}$ ,	$V_{IC} = 1.5\text{ V}$ , $R_S = 50\ \Omega$	25°C	2.8	7	nA
				Full range		75	
$I_{IB}$	Input bias current	$V_{DD} = 3\text{ V}$ , $V_O = 1.5\text{ V}$ ,	$V_{IC} = 1.5\text{ V}$ , $R_S = 50\ \Omega$	25°C	4.4	14	nA
				Full range		75	
$V_{OH}$	High-level output voltage	$I_{OH} = -2.5\text{ mA}$		25°C	2.9		V
				Full range	2.8		
		$I_{OH} = -10\text{ mA}$		25°C	2.7		
				Full range	2.5		
$V_{OL}$	Low-level output voltage	$V_{IC} = 1.5\text{ V}$ ,	$I_{OL} = 2.5\text{ mA}$	25°C	0.1		V
				Full range	0.2		
		$V_{IC} = 1.5\text{ V}$ ,	$I_{OL} = 10\text{ mA}$	25°C	0.3		
				Full range	0.5		
$I_{OS}$	Short-circuit output current	Sourcing		25°C	50		mA
				Full range	20		
		Sinking		25°C	40		
				Full range	20		
$I_O$	Output current	Measured 1 V from rail	25°C	$\pm 40$		mA	
$A_{VD}$	Large-signal differential voltage amplification	$R_L = 10\text{ k}\Omega$		25°C	90	105	dB
				Full range	89		
$r_{i(d)}$	Differential input resistance		25°C	$10^9$		$\Omega$	
$c_{i(c)}$	Common-mode input capacitance	$f = 10\text{ kHz}$	25°C	7		pF	
$z_o$	Closed-loop output impedance	$f = 100\text{ kHz}$ , $A_V = 10$	25°C	33		$\Omega$	
CMRR	Common-mode rejection ratio	$V_{ICR} = 0\text{ V to }3\text{ V}$ , $R_S = 50\ \Omega$		25°C	66	80	dB
				Full range	60		
$k_{SVR}$	Supply voltage rejection ratio ( $\Delta V_{DD} / \Delta V_{IO}$ )	$V_{DD} = 2.7\text{ V to }6\text{ V}$ , No load	$V_{IC} = V_{DD}/2$ ,	25°C	80	85	dB
				Full range	75		
		$V_{DD} = 3\text{ V to }5\text{ V}$ , No load	$V_{IC} = V_{DD}/2$ ,	25°C	85	95	
				Full range	80		
$I_{DD}$	Supply current (per channels)	$V_O = 1.5\text{ V}$ ,	No load	25°C	0.5	0.575	mA
				Full range	0.9		
$I_{DD(SHDN)}$	Supply current in shutdown (TLV2460, TLV2463)	$\overline{SHDN} < 0.7\text{ V}$ , Per channel in shutdown		25°C	0.3		$\mu\text{A}$
				Full range	2.5		

† Full range is  $-40^\circ\text{C}$  to  $125^\circ\text{C}$  for the Q suffix and  $-55^\circ\text{C}$  to  $125^\circ\text{C}$  for the M suffix.



**TLV2460A-EP TLV2461A-EP TLV2462A-EP TLV2463A-EP TLV2464A-EP**  
**FAMILY OF LOW-POWER RAIL-TO-RAIL INPUT/OUTPUT**  
**OPERATIONAL AMPLIFIERS WITH SHUTDOWN**

SGLS132C – AUGUST 2002 – REVISED OCTOBER 2005

operating characteristics at specified free-air temperature,  $V_{DD} = 3\text{ V}$  (unless otherwise noted)

PARAMETER		TEST CONDITIONS		$T_A$ †	MIN	TYP	MAX	UNIT
SR	Slew rate at unity gain	$V_{O(PP)} = 2\text{ V}$ , $R_L = 10\text{ k}\Omega$	$C_L = 160\text{ pF}$	25°C	1	1.6		V/ $\mu\text{s}$
				Full range	0.8			
$V_n$	Equivalent input noise voltage	f = 100 Hz		25°C		16		nV/ $\sqrt{\text{Hz}}$
		f = 1 kHz		25°C		11		
$I_n$	Equivalent input noise current	f = 1 kHz		25°C		0.13		pA/ $\sqrt{\text{Hz}}$
THD + N	Total harmonic distortion plus noise	$V_{O(PP)} = 2\text{ V}$ , $R_L = 10\text{ k}\Omega$ , f = 1 kHz		$A_V = 1$	25°C	0.006%		
				$A_V = 10$		0.02%		
				$A_V = 100$		0.08%		
$t_{(on)}$	Amplifier turnon time	$A_V = 1$ , $R_L = 10\text{ k}\Omega$		Both channels	25°C	7.6		$\mu\text{s}$
				Channel 1 only, Channel 2 on		7.65		
$t_{(off)}$	Amplifier turnoff time	$A_V = 1$ , $R_L = 10\text{ k}\Omega$		Both channels	25°C	333		ns
				Channel 1 only, Channel 2 on		328		
				Channel 2 only, Channel 1 on		329		
Gain-bandwidth product		f = 10 kHz, $C_L = 160\text{ pF}$	$R_L = 10\text{ k}\Omega$ ,	25°C		5.2		MHz
$t_s$	Settling time	$V_{(STEP)PP} = 2\text{ V}$ , $A_V = -1$ , $C_L = 10\text{ pF}$ , $R_L = 10\text{ k}\Omega$		0.1%	25°C	1.47		$\mu\text{s}$
				0.01%		1.78		
		$V_{(STEP)PP} = 2\text{ V}$ , $A_V = -1$ , $C_L = 56\text{ pF}$ , $R_L = 10\text{ k}\Omega$		0.1%		1.77		
				0.01%		1.98		
$\phi_m$	Phase margin at unity gain	$R_L = 10\text{ k}\Omega$ ,	$C_L = 160\text{ pF}$	25°C		44°		
	Gain margin			25°C		7		dB

† Full range is -40°C to 125°C for the Q suffix and -55°C to 125°C for the M suffix.



**TLV2460A-EP TLV2461A-EP TLV2462A-EP TLV2463A-EP TLV2464A-EP**  
**FAMILY OF LOW-POWER RAIL-TO-RAIL INPUT/OUTPUT**  
**OPERATIONAL AMPLIFIERS WITH SHUTDOWN**

SGLS132C – AUGUST 2002 – REVISED OCTOBER 2005

**electrical characteristics at specified free-air temperature,  $V_{DD} = 5\text{ V}$  (unless otherwise noted)**

PARAMETER		TEST CONDITIONS	$T_A$ †	MIN	TYP	MAX	UNIT	
$V_{IO}$	Input offset voltage	$V_{DD} = 5\text{ V}$ , $V_O = 2.5\text{ V}$ ,	$V_{IC} = 2.5\text{ V}$ , $R_S = 50\ \Omega$	25°C	150	1500	$\mu\text{V}$	
				Full range		1700		
$\alpha_{VIO}$	Temperature coefficient of input offset voltage		25°C		2		$\mu\text{V}/^\circ\text{C}$	
$I_{IO}$	Input offset current	$V_{DD} = 5\text{ V}$ , $V_O = 2.5\text{ V}$ ,	$V_{IC} = 2.5\text{ V}$ , $R_S = 50\ \Omega$	25°C	0.3	7	nA	
				Full range		60		
$I_{IB}$	Input bias current	$V_{DD} = 5\text{ V}$ , $V_O = 2.5\text{ V}$ ,	$V_{IC} = 2.5\text{ V}$ , $R_S = 50\ \Omega$	25°C	1.3	14	nA	
				Full range		60		
$V_{OH}$	High-level output voltage	$I_{OH} = -2.5\text{ mA}$	25°C		4.9		V	
				Full range	4.8			
		$I_{OH} = -10\text{ mA}$	25°C		4.8			
				Full range	4.7			
$V_{OL}$	Low-level output voltage	$V_{IC} = 2.5\text{ V}$ , $I_{OL} = 2.5\text{ mA}$	25°C		0.1		V	
				Full range		0.2		
		$V_{IC} = 2.5\text{ V}$ , $I_{OL} = 10\text{ mA}$	25°C		0.2			
				Full range		0.3		
$I_{OS}$	Short-circuit output current	Sourcing	25°C		145		mA	
				Full range	60			
		Sinking	25°C		100			
				Full range	60			
$I_O$	Output current	Measured at 1 V from rail	25°C		$\pm 80$		mA	
$A_{VD}$	Large-signal differential voltage amplification	$V_{IC} = 2.5\text{ V}$ , $V_O = 1\text{ V to }4\text{ V}$	$R_L = 10\text{ k}\Omega$ ,	25°C	92	109	dB	
				Full range	90			
$r_{i(d)}$	Differential input resistance		25°C		$10^9$		$\Omega$	
$C_{i(c)}$	Common-mode input capacitance	$f = 10\text{ kHz}$	25°C		7		pF	
$Z_O$	Closed-loop output impedance	$f = 100\text{ kHz}$ , $A_V = 10$	25°C		29		$\Omega$	
CMRR	Common-mode rejection ratio	$V_{ICR} = 0\text{ V to }5\text{ V}$ , $R_S = 50\ \Omega$	25°C		71	85	dB	
				Full range	60			
$k_{SVR}$	Supply voltage rejection ratio ( $\Delta V_{DD} / \Delta V_{IO}$ )	$V_{DD} = 2.7\text{ V to }6\text{ V}$ , No load	$V_{IC} = V_{DD}/2$ ,	25°C		80	85	dB
					Full range	75		
		$V_{DD} = 3\text{ V to }5\text{ V}$ , No load	$V_{IC} = V_{DD}/2$ ,	25°C		85	95	dB
					Full range	80		
$I_{DD}$	Supply current (per channel)	$V_O = 2.5\text{ V}$ , No load,	25°C		0.55	0.65	mA	
				Full range		1		
$I_{DD}(\text{SHDN})$	Supply current in shutdown (TLV2460, TLV2463)	$\overline{\text{SHDN}} < 0.7\text{ V}$ , Per channels in shutdown	25°C		1		$\mu\text{A}$	
				Full range		3		

† Full range is  $-40^\circ\text{C}$  to  $125^\circ\text{C}$  for the Q suffix and  $-55^\circ\text{C}$  to  $125^\circ\text{C}$  for the M suffix.



**TLV2460A-EP TLV2461A-EP TLV2462A-EP TLV2463A-EP TLV2464A-EP**  
**FAMILY OF LOW-POWER RAIL-TO-RAIL INPUT/OUTPUT**  
**OPERATIONAL AMPLIFIERS WITH SHUTDOWN**

SGLS132C – AUGUST 2002 – REVISED OCTOBER 2005

operating characteristics at specified free-air temperature,  $V_{DD} = 5\text{ V}$  (unless otherwise noted)

PARAMETER		TEST CONDITIONS		$T_A$ †	MIN	TYP	MAX	UNIT
SR	Slew rate at unity gain	$V_{O(PP)} = 2\text{ V}$ , $R_L = 10\text{ k}\Omega$	$C_L = 160\text{ pF}$	25°C	1	1.6		V/ $\mu\text{s}$
				Full range	0.8			
$V_n$	Equivalent input noise voltage			25°C	14			nV/ $\sqrt{\text{Hz}}$
				25°C	11			
$I_n$	Equivalent input noise current	$f = 100\text{ Hz}$		25°C	0.13			pA/ $\sqrt{\text{Hz}}$
THD + N	Total harmonic distortion plus noise	$V_{O(PP)} = 4\text{ V}$ , $R_L = 10\text{ k}\Omega$ , $f = 10\text{ kHz}$		25°C	$A_V = 1$	0.004%		
					$A_V = 10$	0.01%		
					$A_V = 100$	0.04%		
$t_{(on)}$	Amplifier turnon time	$A_V = 1$ , $R_L = 10\text{ k}\Omega$		25°C	Both channels	7.6		$\mu\text{s}$
					Channel 1 only, Channel 2 on	7.65		
					Channel 2 only, Channel 1 on	7.25		
$t_{(off)}$	Amplifier turnoff time	$A_V = 1$ , $R_L = 10\text{ k}\Omega$		25°C	Both channels	333		ns
					Channel 1 only, Channel 2 on	328		
					Channel 2 only, Channel 1 on	329		
Gain-bandwidth product		$f = 10\text{ kHz}$ , $C_L = 160\text{ pF}$	$R_L = 10\text{ k}\Omega$	25°C	6.4			MHz
$t_s$	Settling time	$V_{(STEP)PP} = 2\text{ V}$ , $A_V = -1$ , $C_L = 10\text{ pF}$ , $R_L = 10\text{ k}\Omega$		25°C	0.1%	1.53		$\mu\text{s}$
					0.01%	1.83		
		$V_{(STEP)PP} = 2\text{ V}$ , $A_V = -1$ , $C_L = 56\text{ pF}$ , $R_L = 10\text{ k}\Omega$			0.1%	3.13		
					0.01%	3.33		
$\phi_m$	Phase margin at unity gain	$R_L = 10\text{ k}\Omega$ , $C_L = 160\text{ pF}$		25°C	45°			
	Gain margin			25°C	7		dB	

† Full range is  $-40^\circ\text{C}$  to  $125^\circ\text{C}$  for the Q suffix and  $-55^\circ\text{C}$  to  $125^\circ\text{C}$  for the M suffix.





**TLV2460A-EP TLV2461A-EP TLV2462A-EP TLV2463A-EP TLV2464A-EP**  
**FAMILY OF LOW-POWER RAIL-TO-RAIL INPUT/OUTPUT**  
**OPERATIONAL AMPLIFIERS WITH SHUTDOWN**

SGLS132C – AUGUST 2002 – REVISED OCTOBER 2005

**TYPICAL CHARACTERISTICS**

**Table of Graphs**

		<b>FIGURE</b>
$V_{IO}$	Input offset voltage	vs Common-mode input voltage 1, 2
$I_{IB}$	Input bias current	vs Free-air temperature 3, 4
$I_{IO}$	Input offset current	vs Free-air temperature 3, 4
$V_{OH}$	High-level output voltage	vs High-level output current 5, 6
$V_{OL}$	Low-level output voltage	vs Low-level output current 7, 8
$V_{O(PP)}$	Peak-to-peak output voltage	vs Frequency 9, 10
	Open-loop gain	vs Frequency 11, 12
	Phase	vs Frequency 11, 12
$A_{VD}$	Differential voltage amplification	vs Load resistance 13
	Capacitive load	vs Load resistance 14
$Z_o$	Output impedance	vs Frequency 15, 16
CMRR	Common-mode rejection ratio	vs Frequency 17
$k_{SVR}$	Supply-voltage rejection ratio	vs Frequency 18, 19
$I_{DD}$	Supply current	vs Supply voltage 20
		vs Free-air temperature 21
	Amplifier turnon characteristics	22
	Amplifier turnoff characteristics	23
	Supply current turnon	24
	Supply current turnoff	25
	Shutdown supply current	vs Free-air temperature 26
SR	Slew rate	vs Supply voltage 27
$V_n$	Equivalent input noise voltage	vs Frequency 28, 29
		vs Common-mode input voltage 30, 31
THD	Total harmonic distortion	vs Frequency 32, 33
THD+N	Total harmonic distortion plus noise	vs Peak-to-peak signal amplitude 34, 35
$\phi_m$	Phase margin	vs Frequency 11, 12
		vs Load capacitance 36
		vs Free-air temperature 37
	Gain bandwidth product	vs Supply voltage 38
		vs Free-air temperature 39
	Large signal follower	40, 41
	Small signal follower	42, 43
	Inverting large signal	44, 45
	Inverting small signal	46, 47

**TLV2460A-EP TLV2461A-EP TLV2462A-EP TLV2463A-EP TLV2464A-EP**  
**FAMILY OF LOW-POWER RAIL-TO-RAIL INPUT/OUTPUT**  
**OPERATIONAL AMPLIFIERS WITH SHUTDOWN**

SGLS132C – AUGUST 2002 – REVISED OCTOBER 2005

**TYPICAL CHARACTERISTICS**

**INPUT OFFSET VOLTAGE**  
**vs**  
**COMMON-MODE INPUT VOLTAGE**

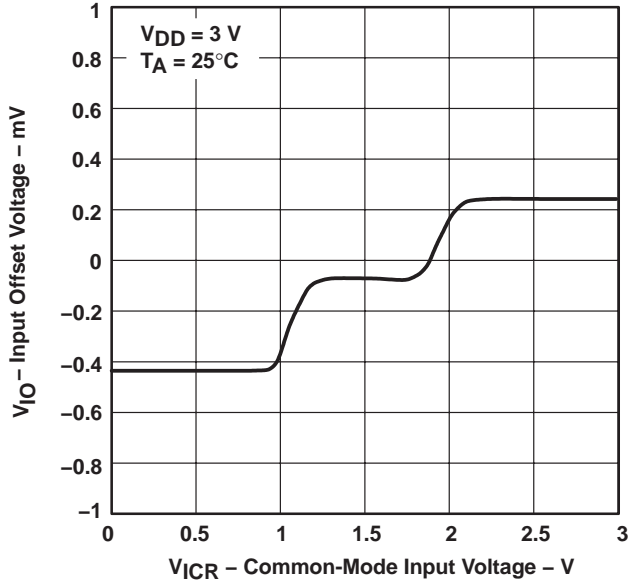

**Figure 2**

**INPUT OFFSET VOLTAGE**  
**vs**  
**COMMON-MODE INPUT VOLTAGE**

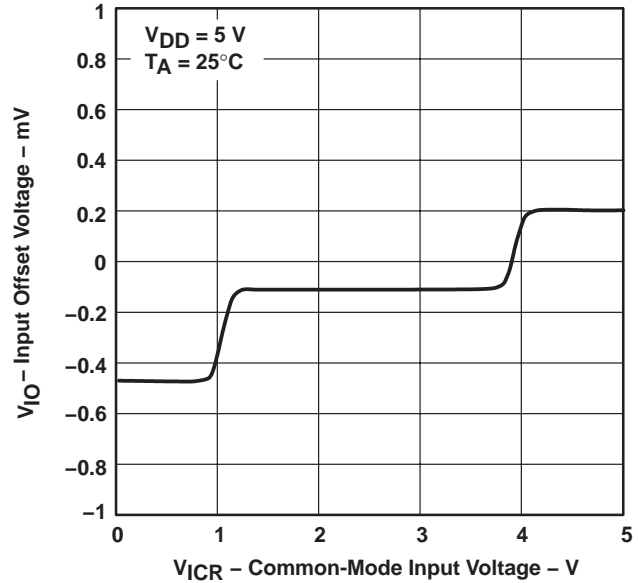

**Figure 3**

**INPUT BIAS AND INPUT OFFSET CURRENT**  
**vs**  
**FREE-AIR TEMPERATURE**

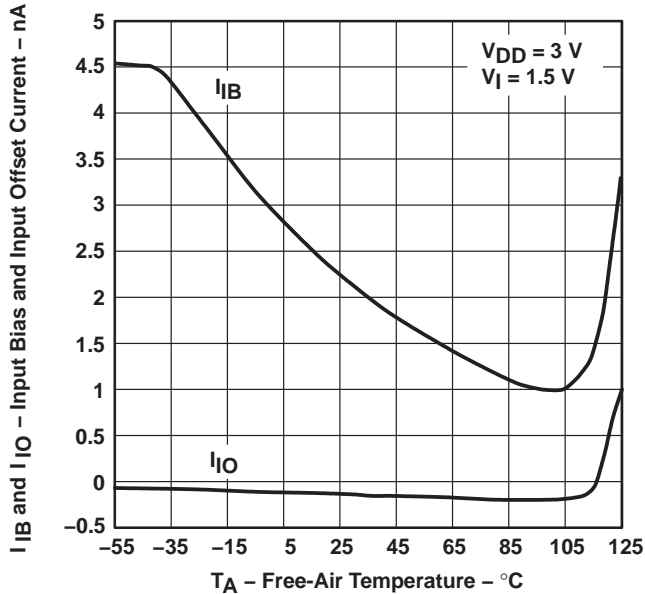

**Figure 4**

**INPUT BIAS AND INPUT OFFSET CURRENT**  
**vs**  
**FREE-AIR TEMPERATURE**

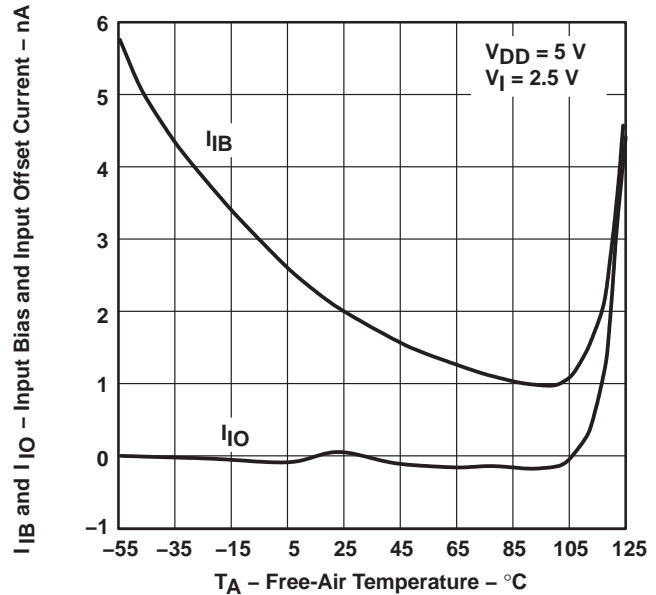

**Figure 5**



**TLV2460A-EP TLV2461A-EP TLV2462A-EP TLV2463A-EP TLV2464A-EP**  
**FAMILY OF LOW-POWER RAIL-TO-RAIL INPUT/OUTPUT**  
**OPERATIONAL AMPLIFIERS WITH SHUTDOWN**

SGLS132C – AUGUST 2002 – REVISED OCTOBER 2005

**TYPICAL CHARACTERISTICS**

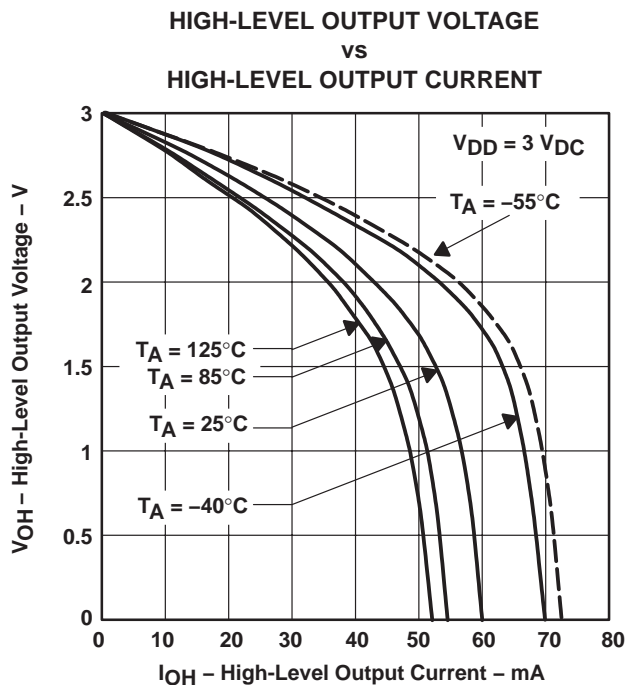

**Figure 6**

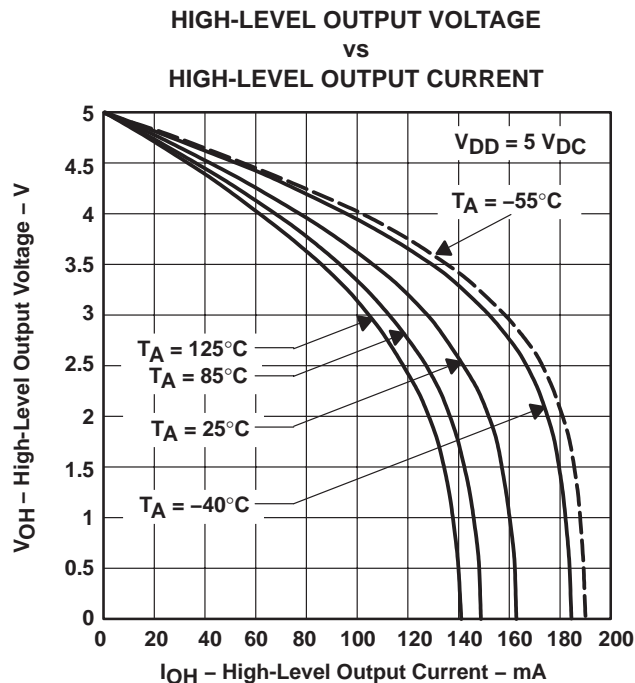

**Figure 7**

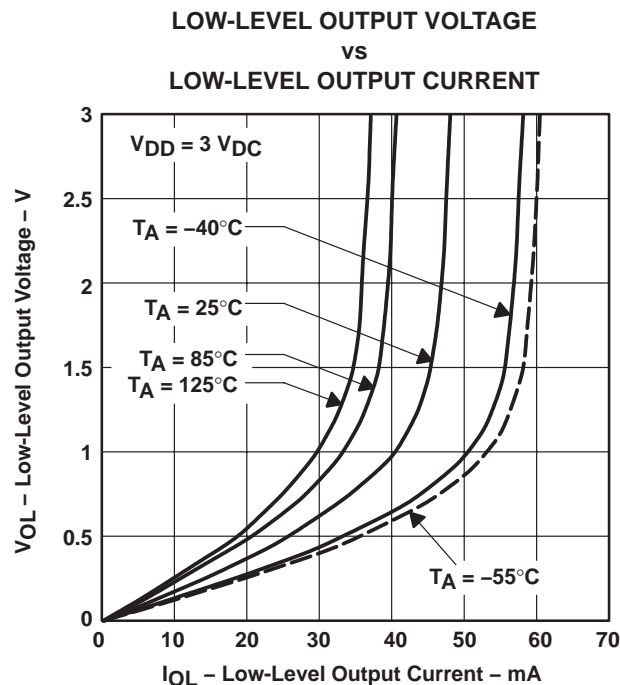

**Figure 8**

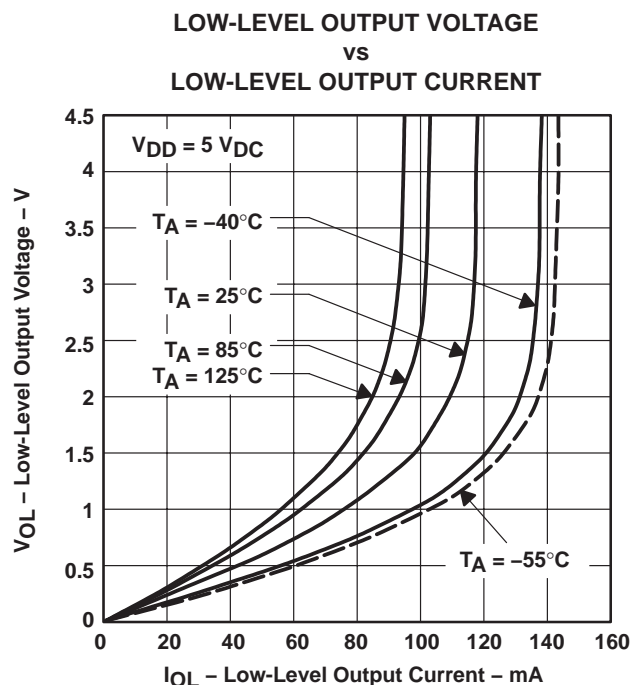

**Figure 9**

**TLV2460A-EP TLV2461A-EP TLV2462A-EP TLV2463A-EP TLV2464A-EP**  
**FAMILY OF LOW-POWER RAIL-TO-RAIL INPUT/OUTPUT**  
**OPERATIONAL AMPLIFIERS WITH SHUTDOWN**

SGLS132C – AUGUST 2002 – REVISED OCTOBER 2005

**TYPICAL CHARACTERISTICS**

**PEAK-TO-PEAK OUTPUT VOLTAGE  
 VS  
 FREQUENCY**

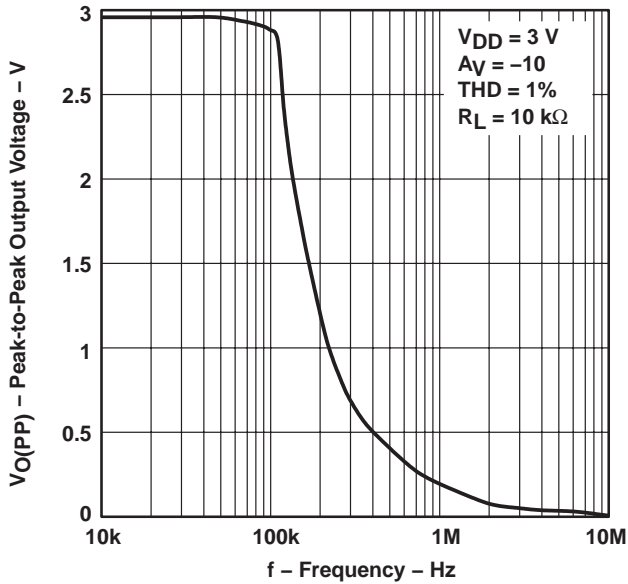

**Figure 10**

**PEAK-TO-PEAK OUTPUT VOLTAGE  
 VS  
 FREQUENCY**

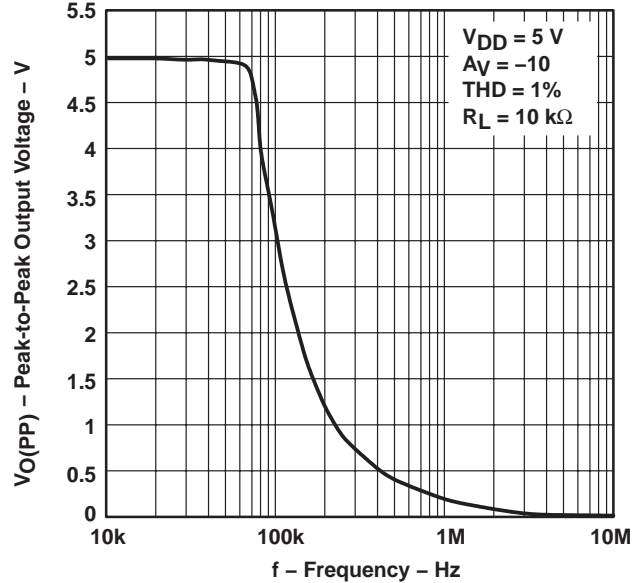

**Figure 11**

**OPEN-LOOP GAIN AND PHASE  
 VS  
 FREQUENCY**

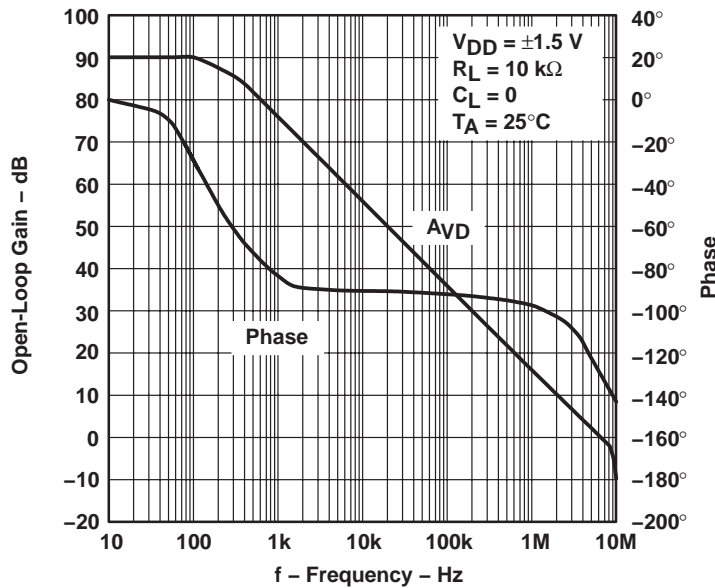

**Figure 12**



TLV2460A-EP TLV2461A-EP TLV2462A-EP TLV2463A-EP TLV2464A-EP  
 FAMILY OF LOW-POWER RAIL-TO-RAIL INPUT/OUTPUT  
 OPERATIONAL AMPLIFIERS WITH SHUTDOWN

SGLS132C – AUGUST 2002 – REVISED OCTOBER 2005

TYPICAL CHARACTERISTICS

OPEN-LOOP GAIN AND PHASE  
 VS  
 FREQUENCY

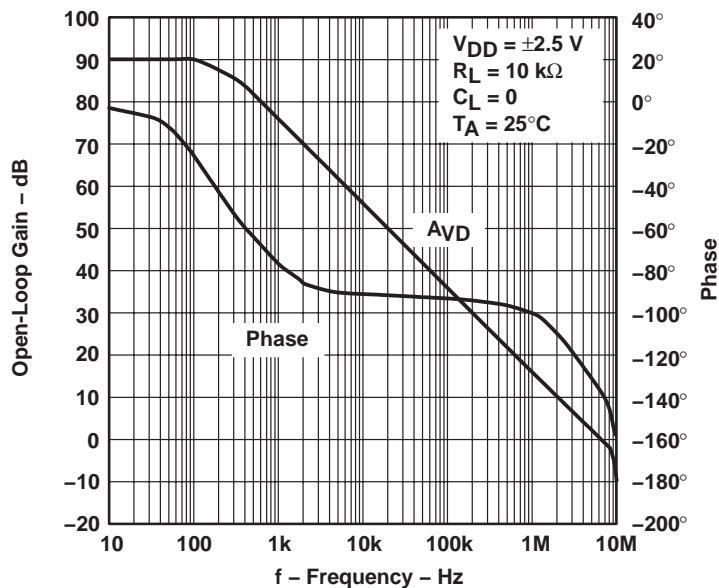

Figure 13

DIFFERENTIAL VOLTAGE AMPLIFICATION  
 VS  
 LOAD RESISTANCE

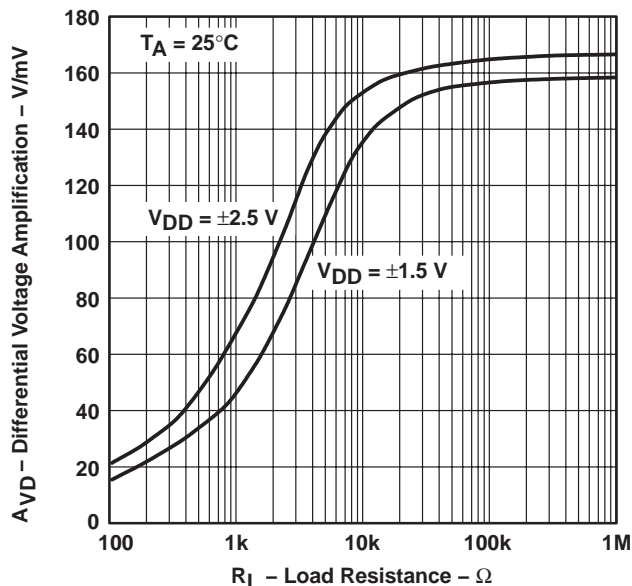

Figure 14

CAPACITIVE LOAD  
 VS  
 LOAD RESISTANCE

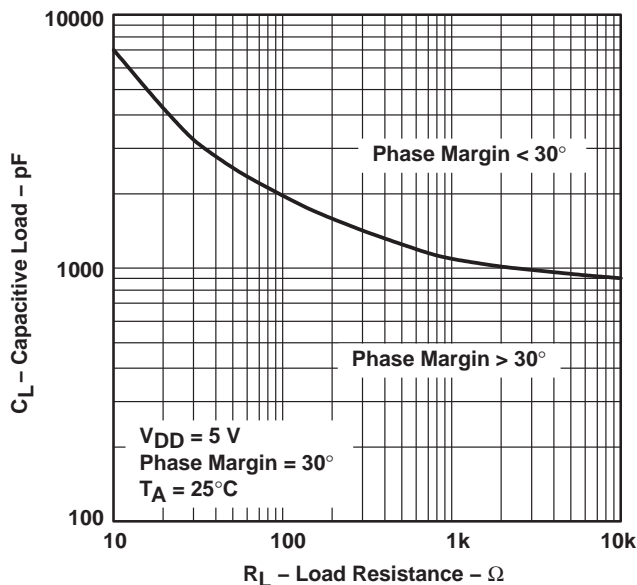
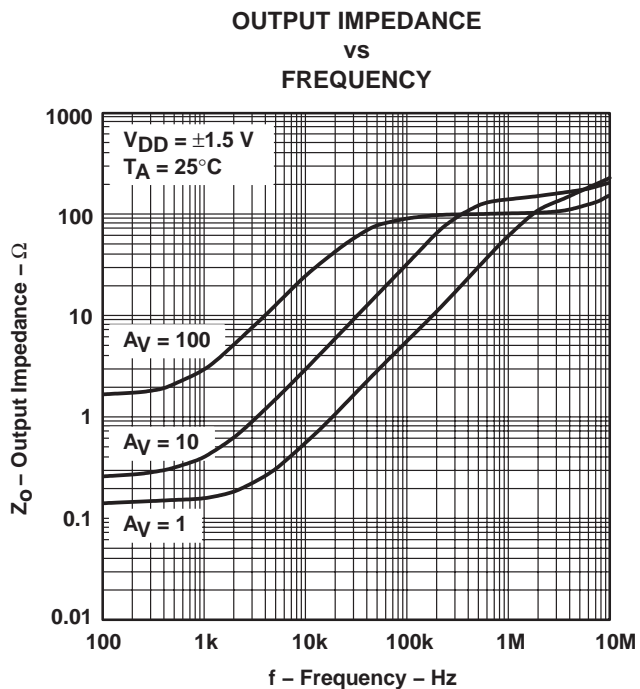

Figure 15

**TLV2460A-EP TLV2461A-EP TLV2462A-EP TLV2463A-EP TLV2464A-EP**  
**FAMILY OF LOW-POWER RAIL-TO-RAIL INPUT/OUTPUT**  
**OPERATIONAL AMPLIFIERS WITH SHUTDOWN**

SGLS132C – AUGUST 2002 – REVISED OCTOBER 2005

**TYPICAL CHARACTERISTICS**



**Figure 16**

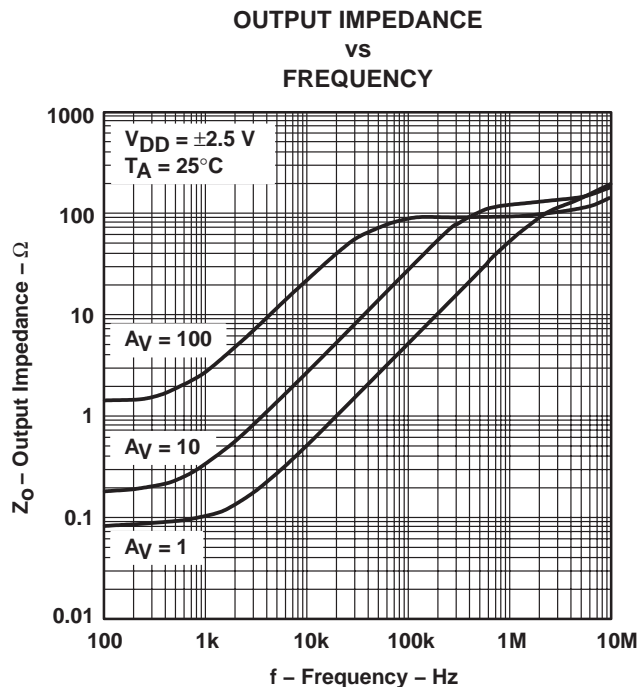

**Figure 17**

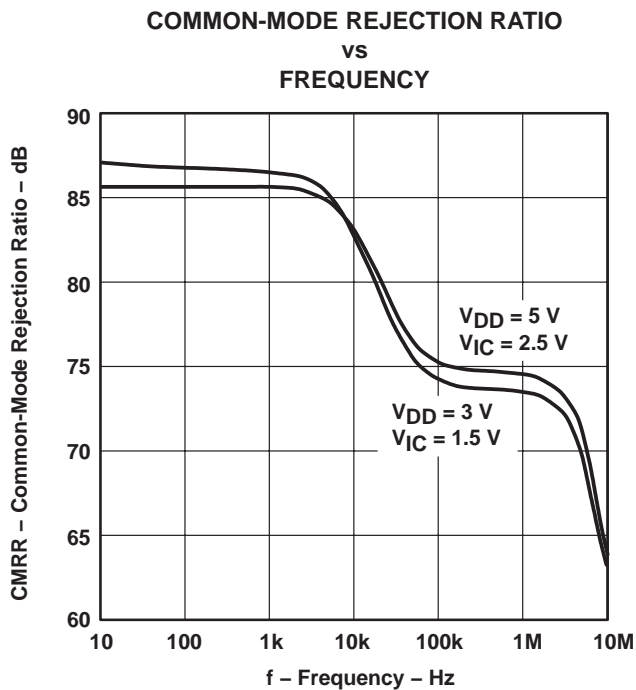

**Figure 18**



**TLV2460A-EP TLV2461A-EP TLV2462A-EP TLV2463A-EP TLV2464A-EP**  
**FAMILY OF LOW-POWER RAIL-TO-RAIL INPUT/OUTPUT**  
**OPERATIONAL AMPLIFIERS WITH SHUTDOWN**

SGLS132C – AUGUST 2002 – REVISED OCTOBER 2005

**TYPICAL CHARACTERISTICS**

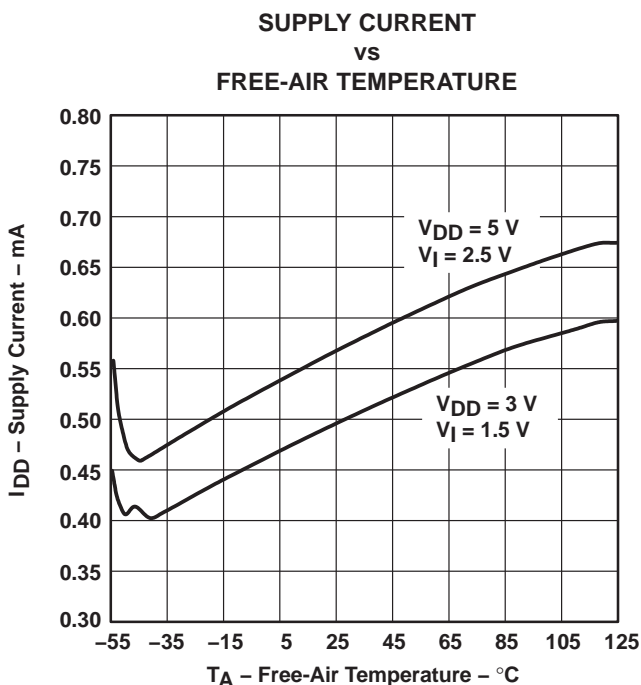
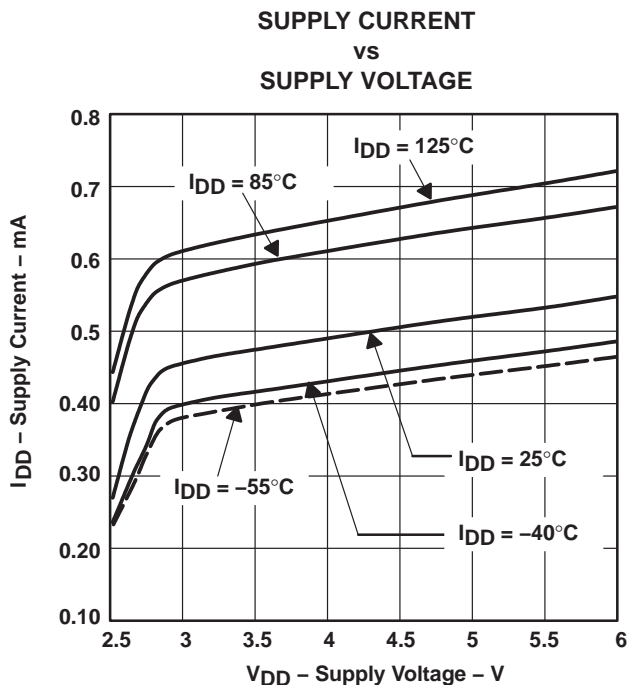
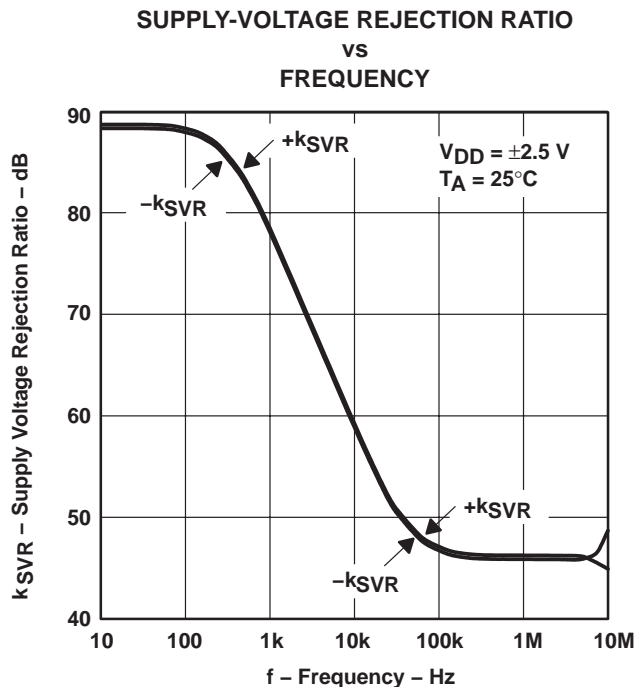
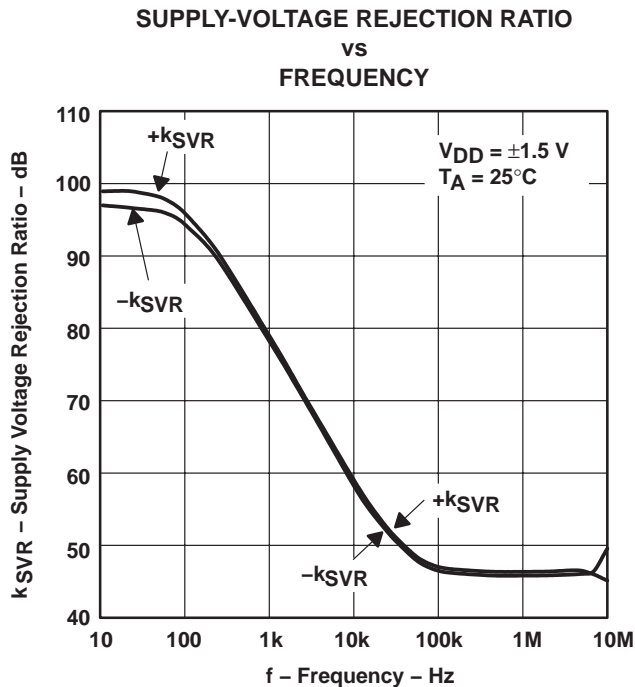

**TLV2460A-EP TLV2461A-EP TLV2462A-EP TLV2463A-EP TLV2464A-EP**  
**FAMILY OF LOW-POWER RAIL-TO-RAIL INPUT/OUTPUT**  
**OPERATIONAL AMPLIFIERS WITH SHUTDOWN**

SGLS132C – AUGUST 2002 – REVISED OCTOBER 2005

**TYPICAL CHARACTERISTICS**

**AMPLIFIER WITH A SHUTDOWN PULSE  
TURNON CHARACTERISTICS**

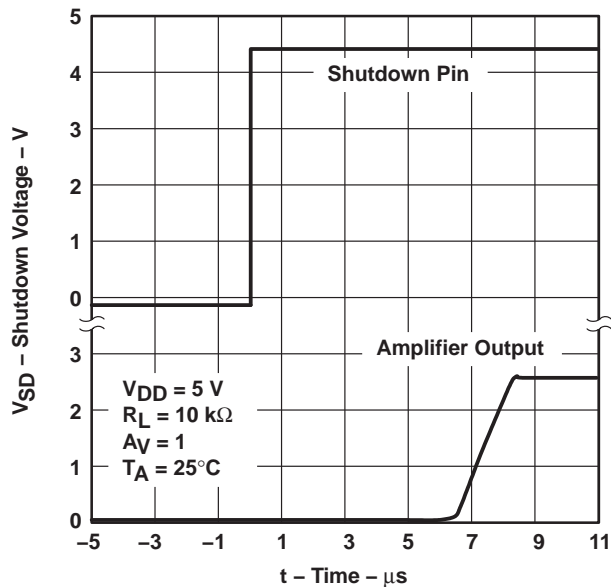

**Figure 23**

**AMPLIFIER WITH A SHUTDOWN PULSE  
TURNOFF CHARACTERISTICS**

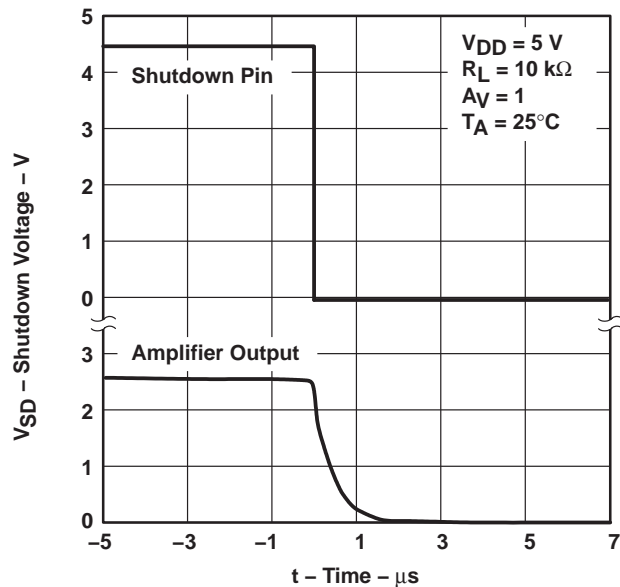

**Figure 24**

**SUPPLY CURRENT WITH A SHUTDOWN PULSE  
TURNON CHARACTERISTICS**

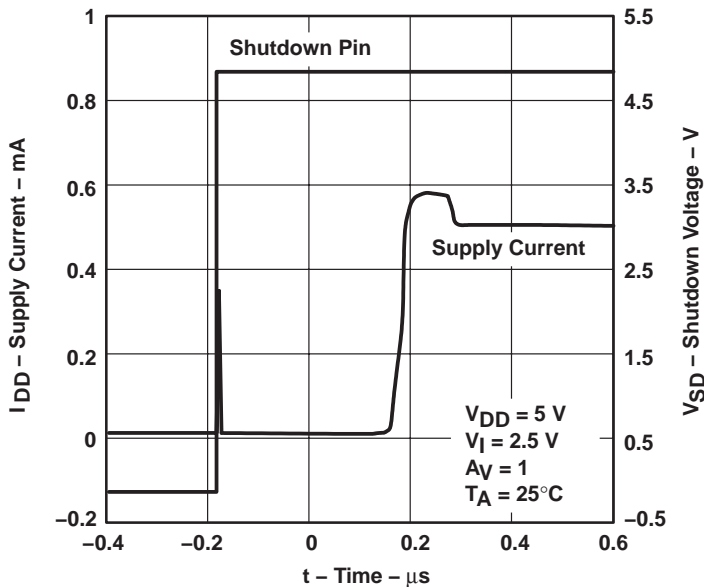

**Figure 25**





TYPICAL CHARACTERISTICS

TURN-OFF SUPPLY CURRENT  
 WITH A SHUTDOWN PULSE

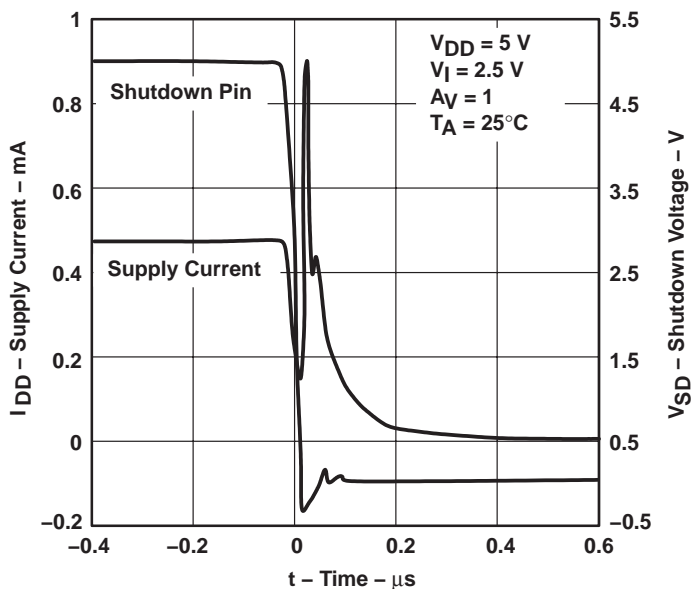

Figure 26

SHUTDOWN SUPPLY CURRENT  
 vs  
 FREE-AIR TEMPERATURE

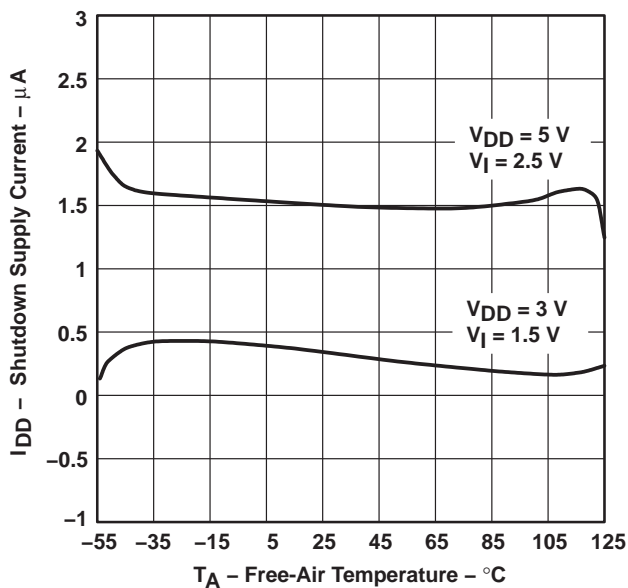

Figure 27

SLEW RATE  
 vs  
 SUPPLY VOLTAGE

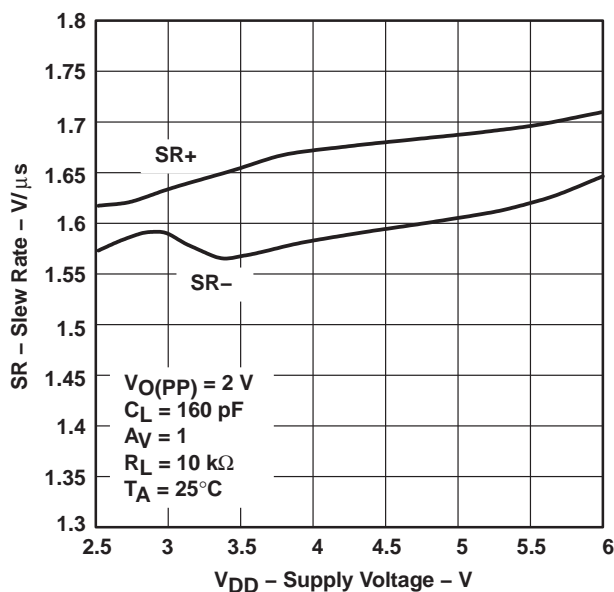

Figure 28

**TLV2460A-EP TLV2461A-EP TLV2462A-EP TLV2463A-EP TLV2464A-EP**  
**FAMILY OF LOW-POWER RAIL-TO-RAIL INPUT/OUTPUT**  
**OPERATIONAL AMPLIFIERS WITH SHUTDOWN**

SGLS132C – AUGUST 2002 – REVISED OCTOBER 2005

**TYPICAL CHARACTERISTICS**

**EQUIVALENT INPUT NOISE VOLTAGE  
 vs  
 FREQUENCY**

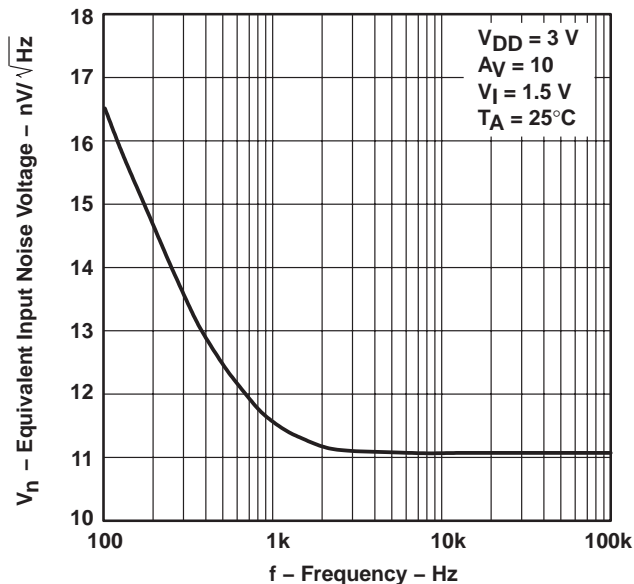

**Figure 29**

**EQUIVALENT INPUT NOISE VOLTAGE  
 vs  
 FREQUENCY**

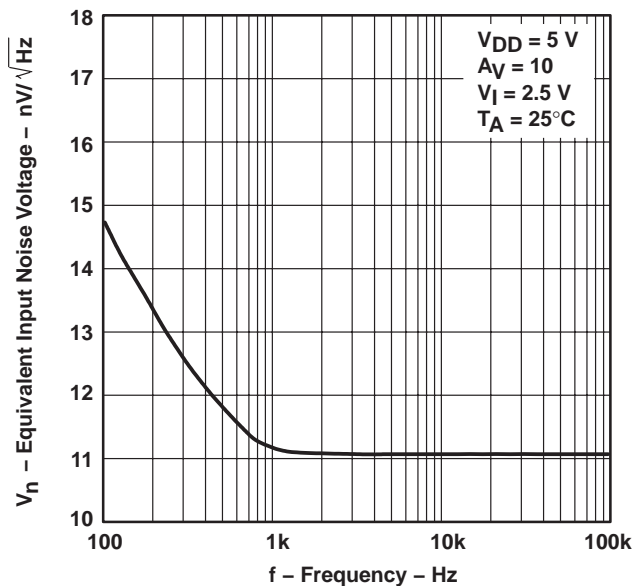

**Figure 30**

**EQUIVALENT INPUT NOISE VOLTAGE  
 vs  
 COMMON-MODE INPUT VOLTAGE**

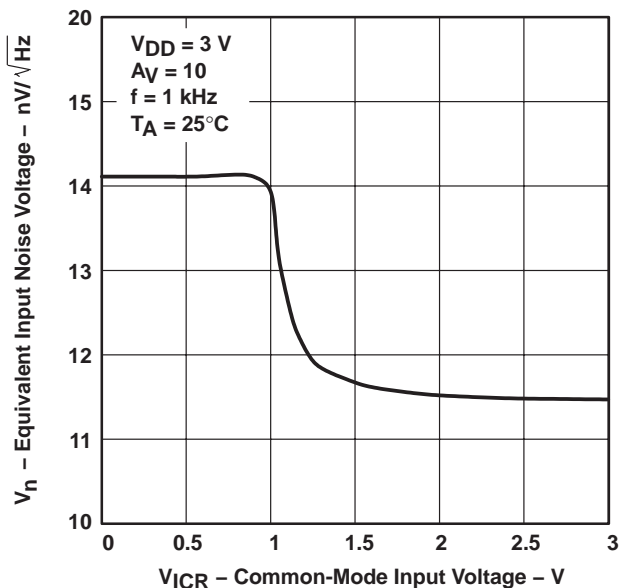

**Figure 31**

**EQUIVALENT INPUT NOISE VOLTAGE  
 vs  
 COMMON-MODE INPUT VOLTAGE**

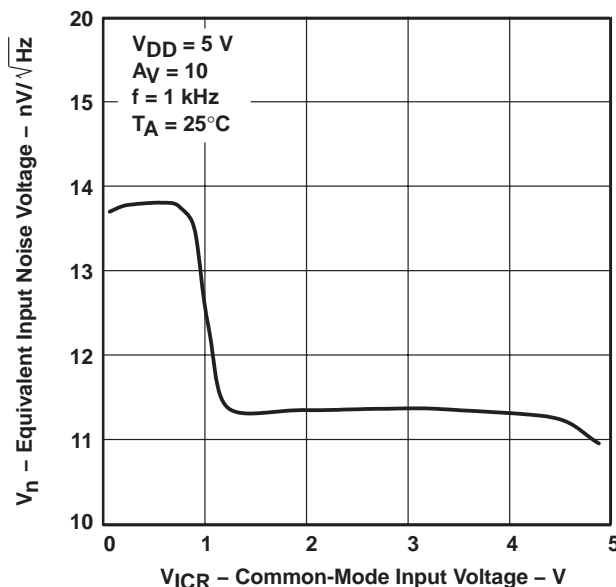

**Figure 32**



TLV2460A-EP TLV2461A-EP TLV2462A-EP TLV2463A-EP TLV2464A-EP  
 FAMILY OF LOW-POWER RAIL-TO-RAIL INPUT/OUTPUT  
 OPERATIONAL AMPLIFIERS WITH SHUTDOWN

SGLS132C – AUGUST 2002 – REVISED OCTOBER 2005

TYPICAL CHARACTERISTICS

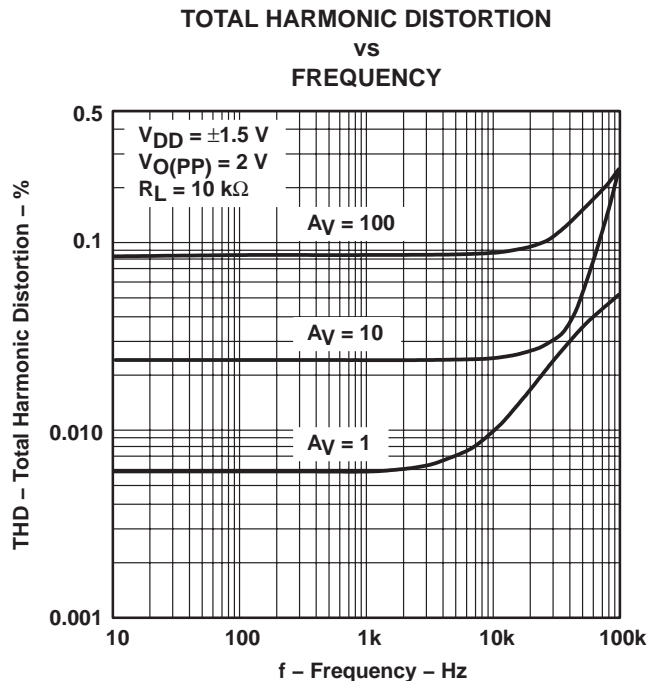

Figure 33

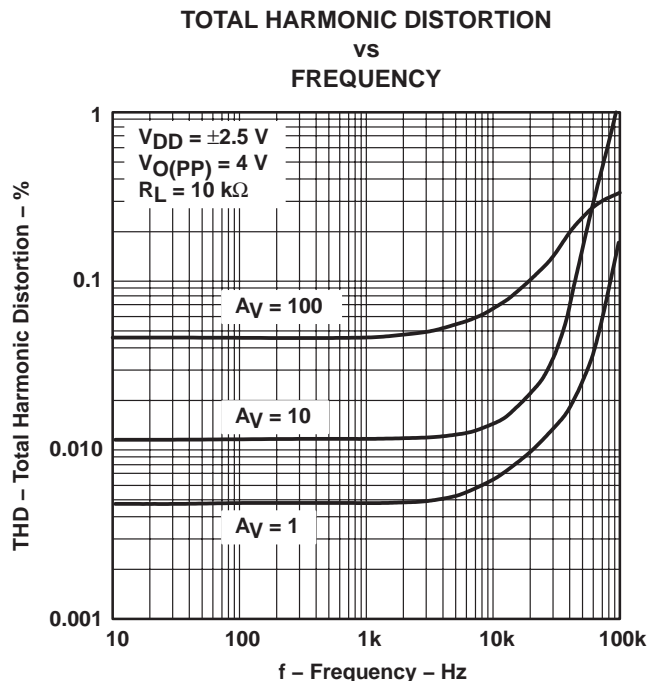

Figure 34

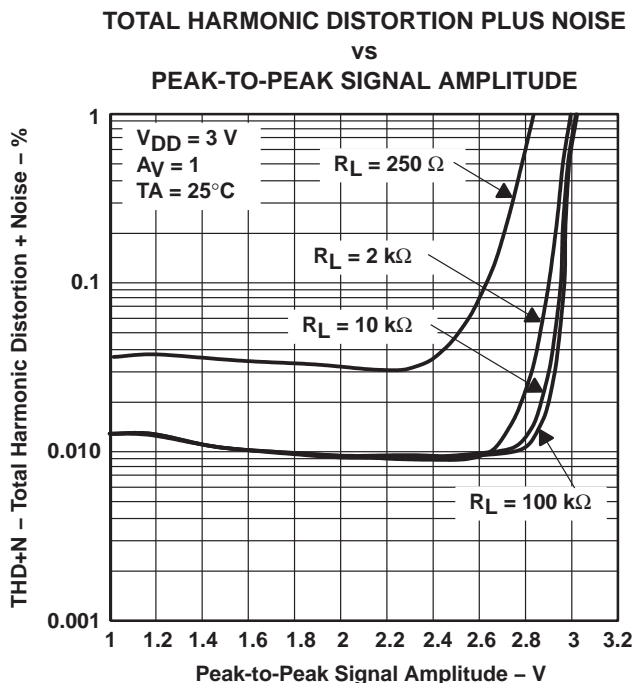

Figure 35

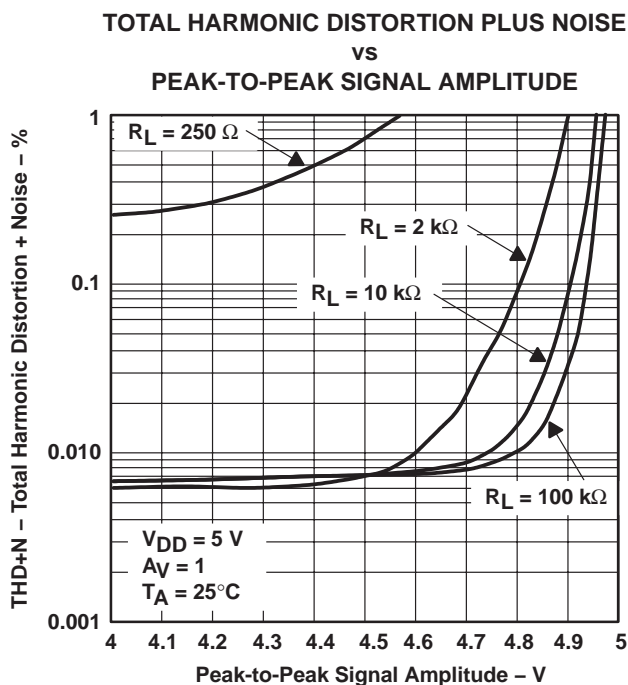

Figure 36



**TLV2460A-EP TLV2461A-EP TLV2462A-EP TLV2463A-EP TLV2464A-EP**  
**FAMILY OF LOW-POWER RAIL-TO-RAIL INPUT/OUTPUT**  
**OPERATIONAL AMPLIFIERS WITH SHUTDOWN**

SGLS132C – AUGUST 2002 – REVISED OCTOBER 2005

**TYPICAL CHARACTERISTICS**

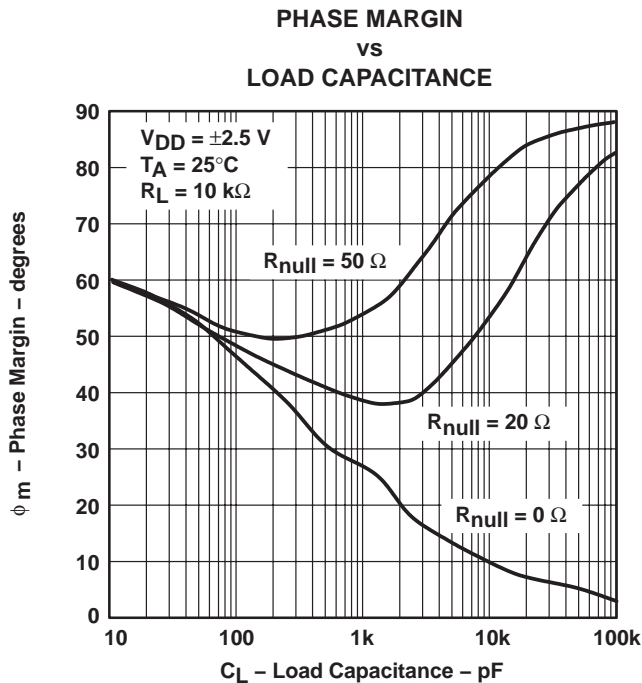

**Figure 37**

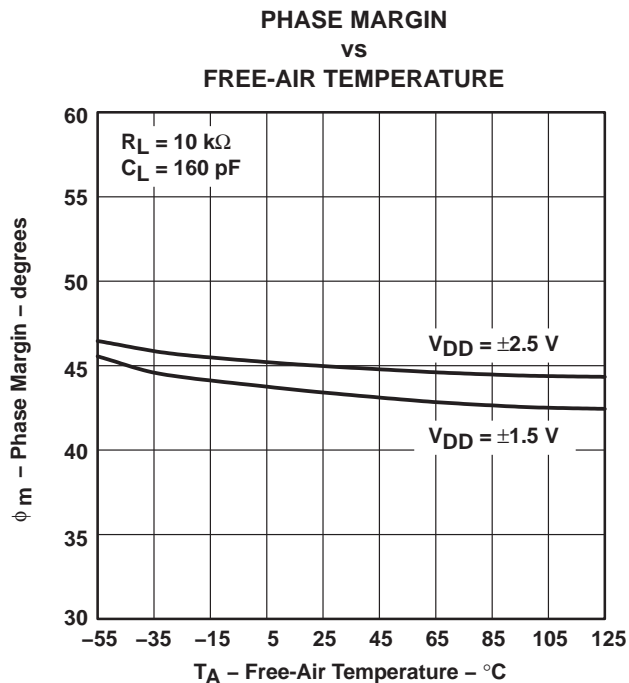

**Figure 38**

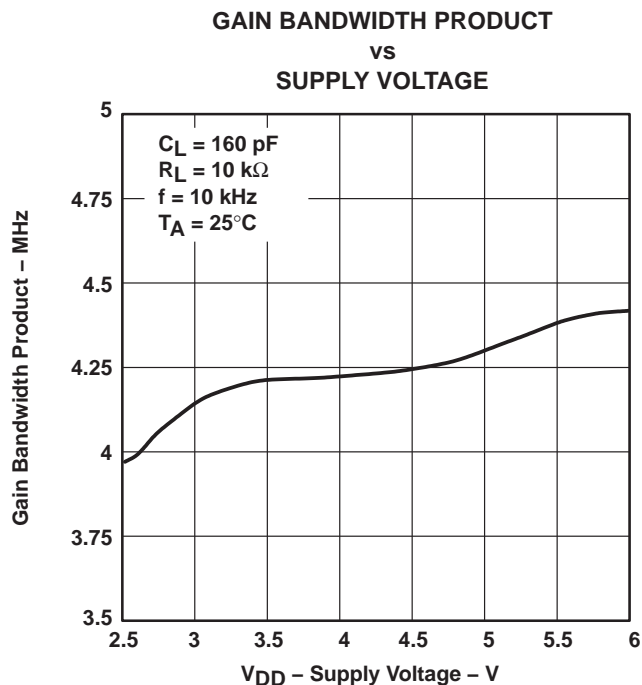

**Figure 39**

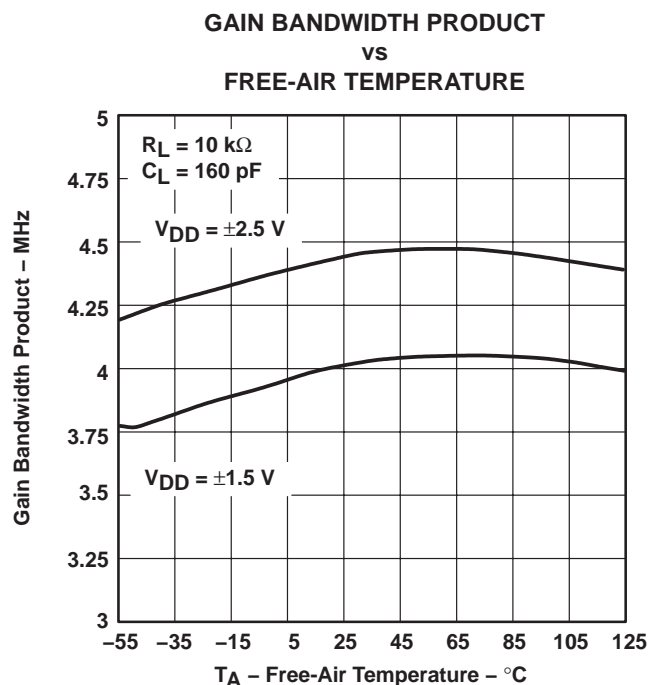

**Figure 40**



TLV2460A-EP TLV2461A-EP TLV2462A-EP TLV2463A-EP TLV2464A-EP  
 FAMILY OF LOW-POWER RAIL-TO-RAIL INPUT/OUTPUT  
 OPERATIONAL AMPLIFIERS WITH SHUTDOWN

SGLS132C – AUGUST 2002 – REVISED OCTOBER 2005

TYPICAL CHARACTERISTICS

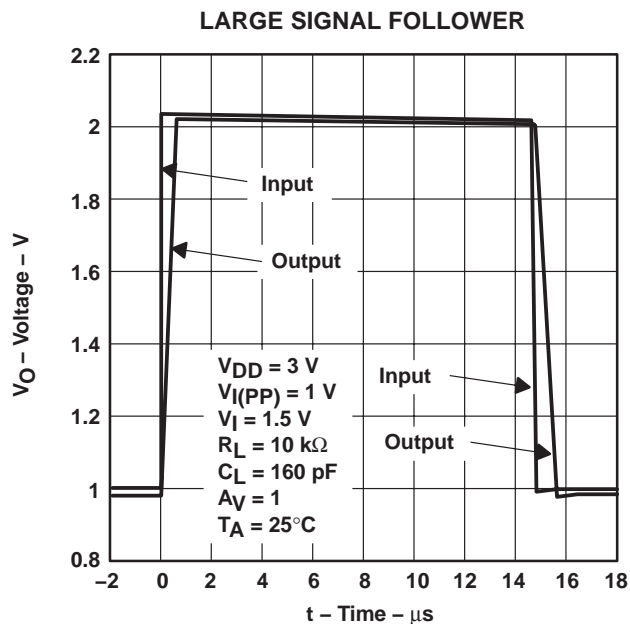

Figure 41

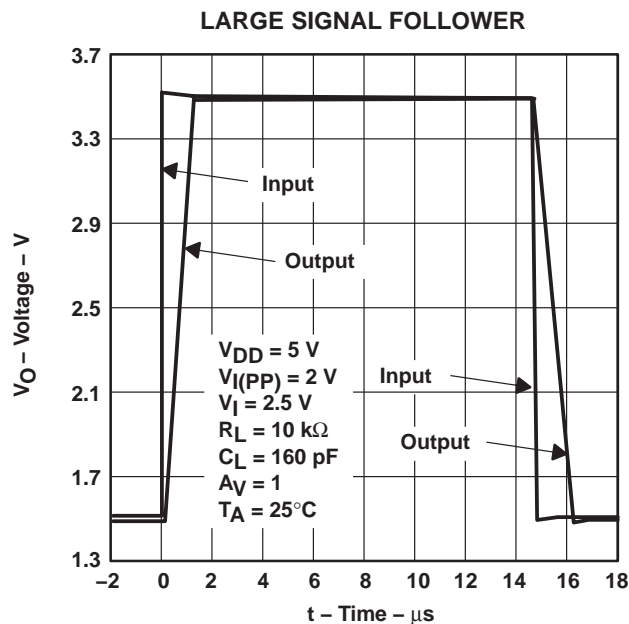

Figure 42

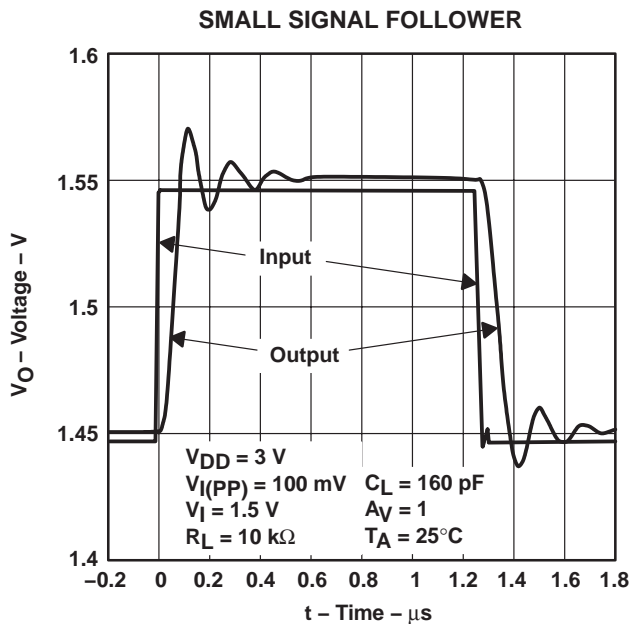

Figure 43

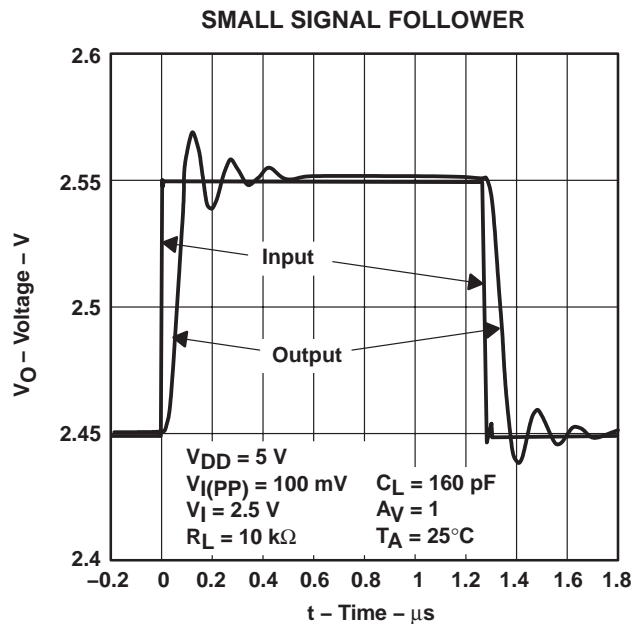
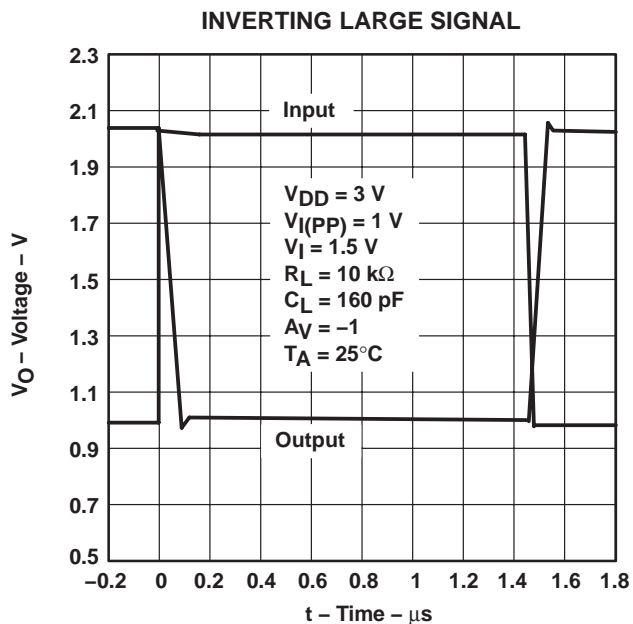

Figure 44

**TLV2460A-EP TLV2461A-EP TLV2462A-EP TLV2463A-EP TLV2464A-EP**  
**FAMILY OF LOW-POWER RAIL-TO-RAIL INPUT/OUTPUT**  
**OPERATIONAL AMPLIFIERS WITH SHUTDOWN**

SGLS132C – AUGUST 2002 – REVISED OCTOBER 2005

**TYPICAL CHARACTERISTICS**



**Figure 45**

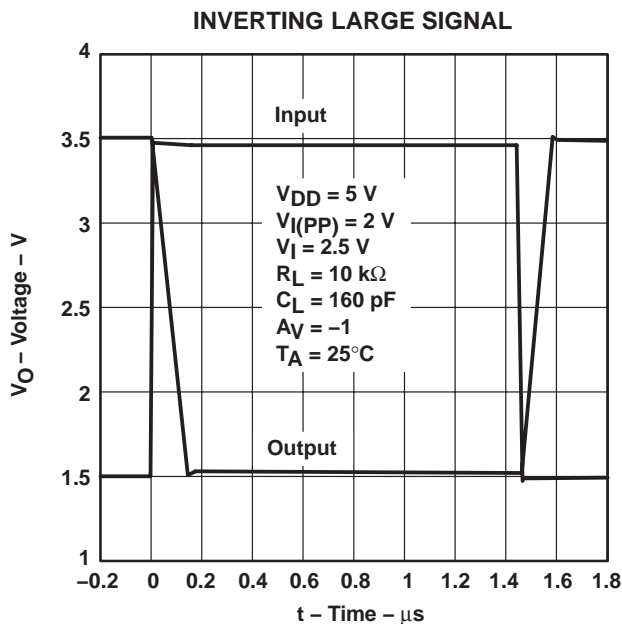

**Figure 46**

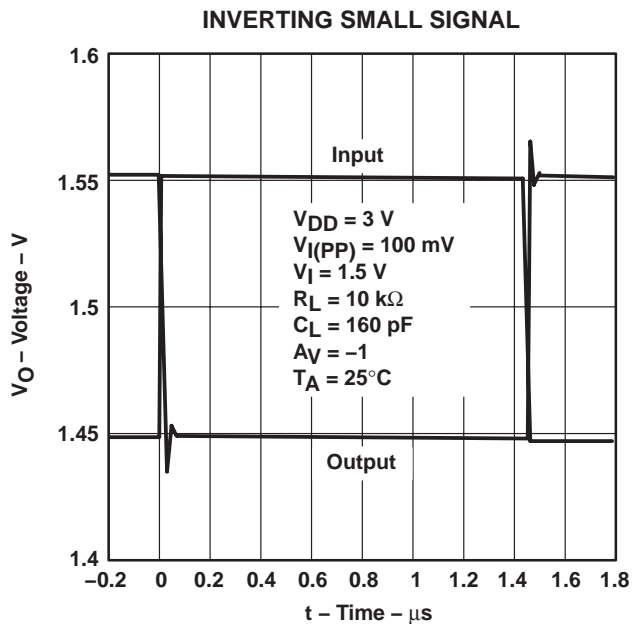

**Figure 47**

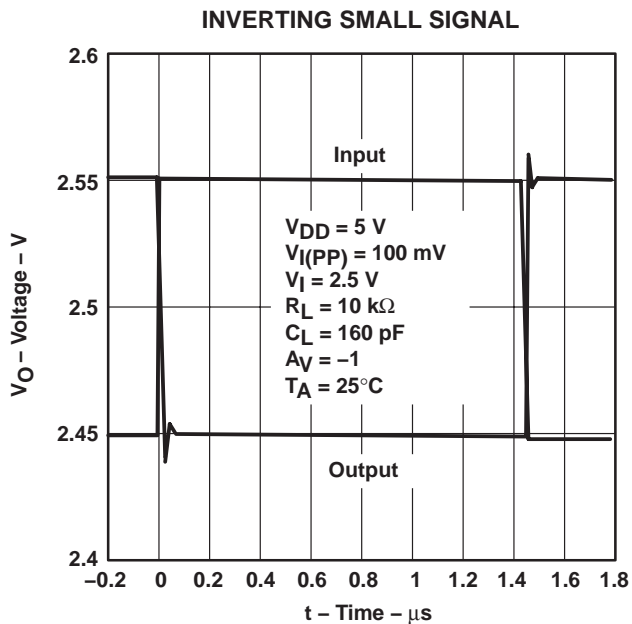

**Figure 48**

PARAMETER MEASUREMENT INFORMATION

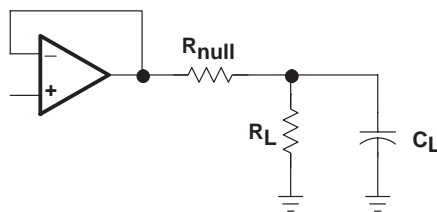

Figure 49

APPLICATION INFORMATION

driving a capacitive load

When the amplifier is configured in this manner, capacitive loading directly on the output will decrease the device's phase margin leading to high frequency ringing or oscillations. Therefore, for capacitive loads of greater than 10 pF, it is recommended that a resistor be placed in series ( $R_{NULL}$ ) with the output of the amplifier, as shown in Figure 49. A minimum value of 20  $\Omega$  should work well for most applications.

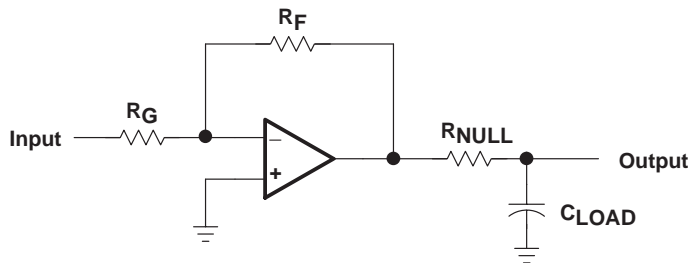

Figure 50. Driving a Capacitive Load

offset voltage

The output offset voltage, ( $V_{OO}$ ) is the sum of the input offset voltage ( $V_{IO}$ ) and both input bias currents ( $I_{IB}$ ) times the corresponding gains. The following schematic and formula can be used to calculate the output offset voltage:

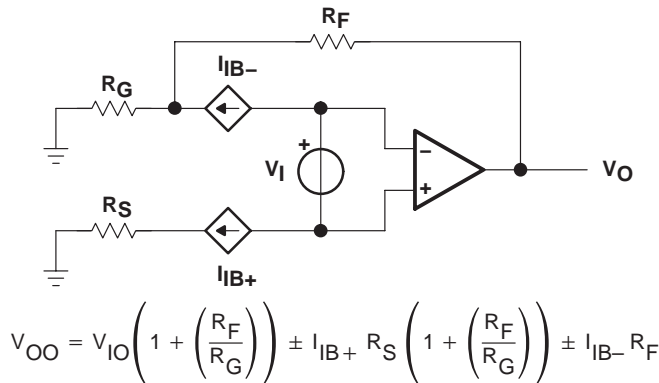
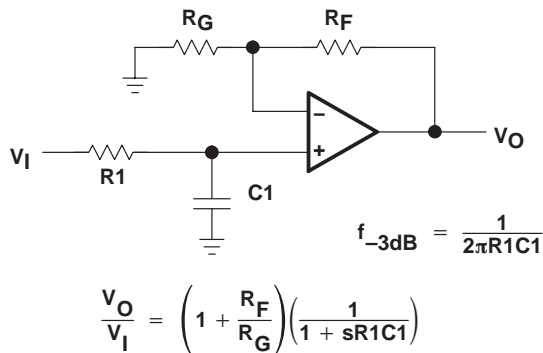

Figure 51. Output Offset Voltage Model

**APPLICATION INFORMATION**

**general configurations**

When receiving low-level signals, limiting the bandwidth of the incoming signals into the system is often required. The simplest way to accomplish this is to place an RC filter at the noninverting terminal of the amplifier (see Figure 51).



**Figure 52. Single-Pole Low-Pass Filter**

If even more attenuation is needed, a multiple pole filter is required. The Sallen-Key filter can be used for this task. For best results, the amplifier should have a bandwidth that is 8 to 10 times the filter frequency bandwidth. Failure to do this can result in phase shift of the amplifier.

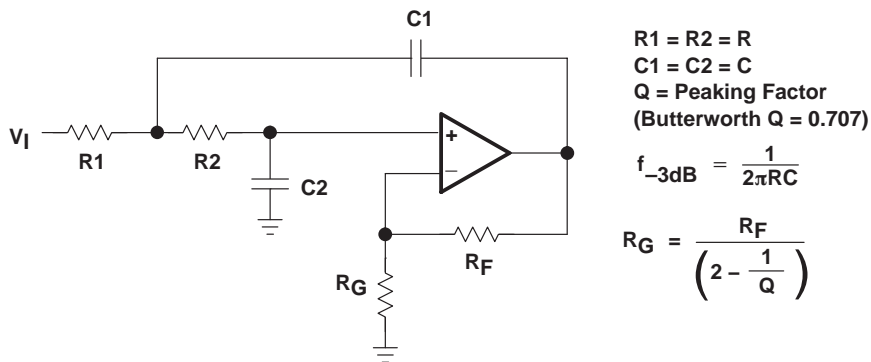

**Figure 53. 2-Pole Low-Pass Sallen-Key Filter**



---

## APPLICATION INFORMATION

### shutdown function

Two members of the TLV246x family (TLV2460/3) have a shutdown terminal for conserving battery life in portable applications. When the shutdown terminal is tied low, the supply current is reduced to 0.3  $\mu\text{A}/\text{channel}$ , the amplifier is disabled, and the outputs are placed in a high impedance mode. To enable the amplifier, the shutdown terminal can either be left floating or pulled high. When the shutdown terminal is left floating, care should be taken to ensure that parasitic leakage current at the shutdown terminal does not inadvertently place the operational amplifier into shutdown. The shutdown terminal threshold is always referenced to  $V_{\text{DD}}/2$ . Therefore, when operating the device with split supply voltages (e.g.  $\pm 2.5\text{ V}$ ), the shutdown terminal needs to be pulled to  $V_{\text{DD-}}$  (not GND) to disable the operational amplifier.

The amplifier's output with a shutdown pulse is shown in Figures 22, 23, 24, and 25. The amplifier is powered with a single 5-V supply and configured as a noninverting configuration with a gain of 5. The amplifier turnon and turnoff times are measured from the 50% point of the shutdown pulse to the 50% point of the output waveform. The times for the single, dual, and quad are listed in the data tables.

### circuit layout considerations

To achieve the levels of high performance of the TLV246x, follow proper printed-circuit board design techniques. A general set of guidelines is given in the following.

- Ground planes – It is highly recommended that a ground plane be used on the board to provide all components with a low inductive ground connection. However, in the areas of the amplifier inputs and output, the ground plane can be removed to minimize the stray capacitance.
- Proper power supply decoupling – Use a 6.8- $\mu\text{F}$  tantalum capacitor in parallel with a 0.1- $\mu\text{F}$  ceramic capacitor on each supply terminal. It may be possible to share the tantalum among several amplifiers depending on the application, but a 0.1- $\mu\text{F}$  ceramic capacitor should always be used on the supply terminal of every amplifier. In addition, the 0.1- $\mu\text{F}$  capacitor should be placed as close as possible to the supply terminal. As this distance increases, the inductance in the connecting trace makes the capacitor less effective. The designer should strive for distances of less than 0.1 inches between the device power terminals and the ceramic capacitors.
- Sockets – Sockets can be used but are not recommended. The additional lead inductance in the socket pins will often lead to stability problems. Surface-mount packages soldered directly to the printed-circuit board is the best implementation.
- Short trace runs/compact part placements – Optimum high performance is achieved when stray series inductance has been minimized. To realize this, the circuit layout should be made as compact as possible, thereby minimizing the length of all trace runs. Particular attention should be paid to the inverting input of the amplifier. Its length should be kept as short as possible. This will help to minimize stray capacitance at the input of the amplifier.
- Surface-mount passive components – Using surface-mount passive components is recommended for high performance amplifier circuits for several reasons. First, because of the extremely low lead inductance of surface-mount components, the problem with stray series inductance is greatly reduced. Second, the small size of surface-mount components naturally leads to a more compact layout thereby minimizing both stray inductance and capacitance. If leaded components are used, it is recommended that the lead lengths be kept as short as possible.

**TLV2460A-EP TLV2461A-EP TLV2462A-EP TLV2463A-EP TLV2464A-EP**  
**FAMILY OF LOW-POWER RAIL-TO-RAIL INPUT/OUTPUT**  
**OPERATIONAL AMPLIFIERS WITH SHUTDOWN**

SGLS132C – AUGUST 2002 – REVISED OCTOBER 2005

**APPLICATION INFORMATION**

**general power dissipation considerations**

For a given  $\theta_{JA}$ , the maximum power dissipation is shown in Figure 53 and is calculated by the following formula:

$$P_D = \left( \frac{T_{MAX} - T_A}{\theta_{JA}} \right)$$

Where:

- $P_D$  = Maximum power dissipation of THS246x IC (watts)
- $T_{MAX}$  = Absolute maximum junction temperature (150°C)
- $T_A$  = Free-ambient air temperature (°C)
- $\theta_{JA}$  =  $\theta_{JC} + \theta_{CA}$
- $\theta_{JC}$  = Thermal coefficient from junction to case
- $\theta_{CA}$  = Thermal coefficient from case to ambient air (°C/W)

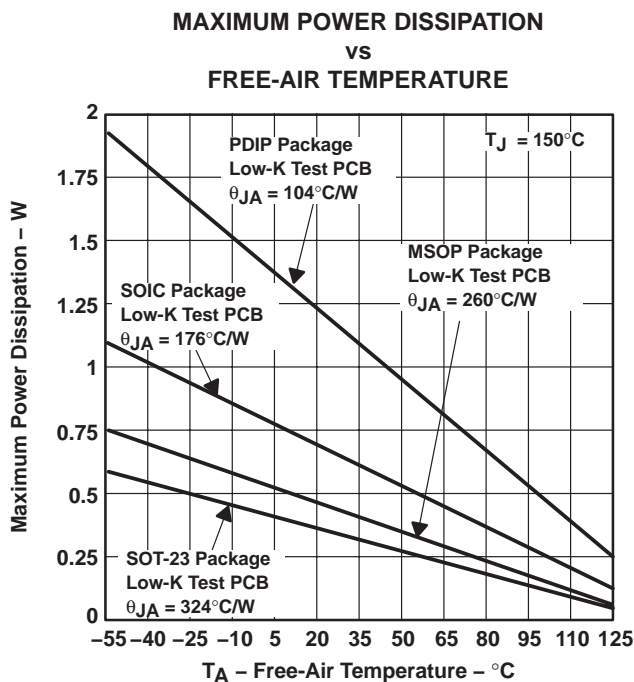

NOTE A: Results are with no air flow and using JEDEC Standard Low-K test PCB.

**Figure 54. Maximum Power Dissipation vs Free-Air Temperature**

# TLV2460A-EP TLV2461A-EP TLV2462A-EP TLV2463A-EP TLV2464A-EP FAMILY OF LOW-POWER RAIL-TO-RAIL INPUT/OUTPUT OPERATIONAL AMPLIFIERS WITH SHUTDOWN

SGLS132C – AUGUST 2002 – REVISED OCTOBER 2005

## APPLICATION INFORMATION

### macromodel information

Macromodel information provided was derived using Microsim *Parts*™ Release 8, the model generation software used with Microsim *PSpice*™. The Boyle macromodel (see Note 2) and subcircuit in Figure 54 are generated using the TLV246x typical electrical and operating characteristics at  $T_A = 25^\circ\text{C}$ . Using this information, output simulations of the following key parameters can be generated to a tolerance of 20% (in most cases):

- Maximum positive output voltage swing
- Maximum negative output voltage swing
- Slew rate
- Quiescent power dissipation
- Input bias current
- Open-loop voltage amplification
- Unity-gain frequency
- Common-mode rejection ratio
- Phase margin
- DC output resistance
- AC output resistance
- Short-circuit output current limit

NOTE 2: G. R. Boyle, B. M. Cohn, D. O. Pederson, and J. E. Solomon, "Macromodeling of Integrated Circuit Operational Amplifiers", *IEEE Journal of Solid-State Circuits*, SC-9, 353 (1974).

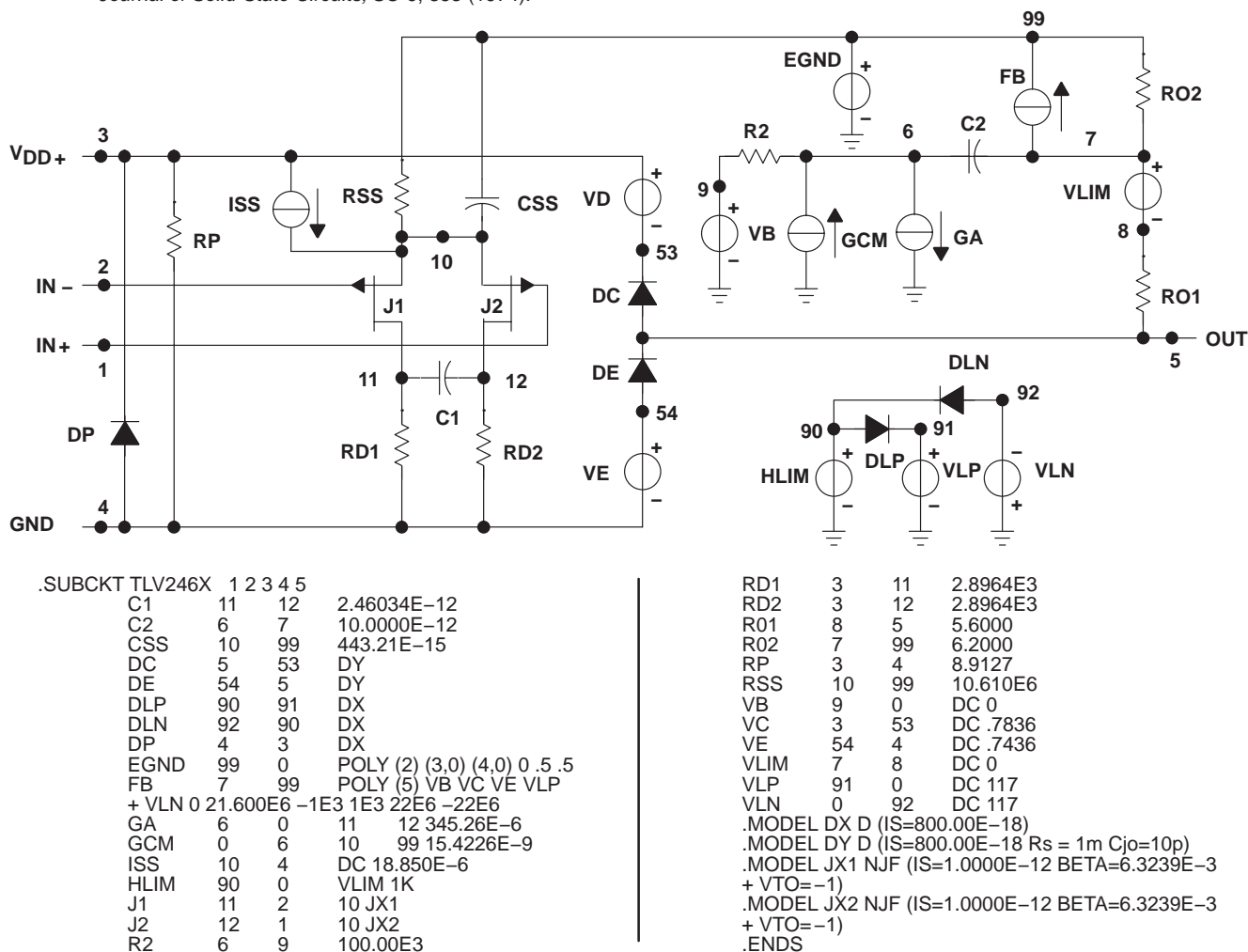

**Figure 55. Boyle Macromodels and Subcircuit**

*PSpice* and *Parts* are trademarks of MicroSim Corporation.



**TLV2460A-EP TLV2461A-EP TLV2462A-EP TLV2463A-EP TLV2464A-EP**  
**FAMILY OF LOW-POWER RAIL-TO-RAIL INPUT/OUTPUT**  
**OPERATIONAL AMPLIFIERS WITH SHUTDOWN**

SGLS132C – AUGUST 2002 – REVISED OCTOBER 2005

**macromodel information (continued)**

.subckt TLV_246Y 1 2 3 4 5 6	rp	3	71	8.9127
c1 11 12 2.4603E-12	rss	10	99	10.610E6
c2 72 7 10.000E-12	rs1	6	4	1G
css 10 99 443.21E-15	rs2	6	4	1G
dc 70 53 dy	rs3	6	4	1G
de 54 70 dy	rs4	6	4	1G
dlp 90 91 dx	s1	71	4	6 4 s1x
dln 92 90 dx	s2	70	5	6 4 s1x
dp 4 3 dx	s3	10	74	6 4 s1x
egnd 99 0 poly(2) (3,0) (4,0) 0 .5 .5	s4	74	4	6 4 s2x
fb 7 99 poly(5) vb vc ve vlp vln 0	vb	9	0	dc 0
21.600E6 -1E3 1E3 22E6 -22E6	vc	3	53	dc .7836
ga 72 0 11 12 345.26E-6	ve	54	4	dc .7436
gcm 0 72 10 99 15.422E-9	vlim	7	8	dc 0
iss 74 4 dc 18.850E-6	vlp	91	0	dc 117
hlim 90 0 vlim 1K	vln	0	92	dc 117
j1 11 2 10 jx1	.model dx D(Is=800.00E-18)			
j2 12 1 10 jx2	.model dy D(Is=800.00E-18 Rs=1m Cjo=10p)			
r2 72 9 100.00E3	.model jx1 NJF(Is=1.0000E-12 Beta=6.3239E-3 Vto=-1)			
rd1 3 11 2.8964E3	.model jx2 NJF(Is=1.0000E-12 Beta=6.3239E-3 Vto=-1)			
rd2 3 12 2.8964E3	.model s1x VSWITCH(Roff=1E8 Ron=1.0 Voff=2.5 Von=0.0)			
ro1 8 70 5.6000	.model s2x VSWITCH(Roff=1E8 Ron=1.0 Voff=0 Von=2.5)			
ro2 7 99 6.2000	.ends			

**Figure 54. Boyle Macromodels and Subcircuit (Continued)**

**PACKAGING INFORMATION**

Orderable Device	Status <sup>(1)</sup>	Package Type	Package Drawing	Pins	Package Qty	Eco Plan <sup>(2)</sup>	Lead/Ball Finish	MSL Peak Temp <sup>(3)</sup>
TLV2462AMDREP	ACTIVE	SOIC	D	8	2500	Green (RoHS & no Sb/Br)	CU NIPDAU	Level-1-260C-UNLIM
TLV2462AQDREP	ACTIVE	SOIC	D	8	2500	Green (RoHS & no Sb/Br)	CU NIPDAU	Level-1-260C-UNLIM
TLV2464AMDREP	ACTIVE	SOIC	D	14	2500	Green (RoHS & no Sb/Br)	CU NIPDAU	Level-1-260C-UNLIM
TLV2464AMDREPG4	ACTIVE	SOIC	D	14	2500	Green (RoHS & no Sb/Br)	CU NIPDAU	Level-1-260C-UNLIM
TLV2464AMPWREP	ACTIVE	TSSOP	PW	14	2000	Green (RoHS & no Sb/Br)	CU NIPDAU	Level-1-260C-UNLIM
V62/03619-03XE	ACTIVE	SOIC	D	8	2500	Green (RoHS & no Sb/Br)	CU NIPDAU	Level-1-260C-UNLIM
V62/03619-06XE	ACTIVE	SOIC	D	8	2500	Green (RoHS & no Sb/Br)	CU NIPDAU	Level-1-260C-UNLIM
V62/03619-07YE	ACTIVE	SOIC	D	14	2500	Green (RoHS & no Sb/Br)	CU NIPDAU	Level-1-260C-UNLIM
V62/03619-07ZE	ACTIVE	TSSOP	PW	14	2000	Green (RoHS & no Sb/Br)	CU NIPDAU	Level-1-260C-UNLIM

<sup>(1)</sup> The marketing status values are defined as follows:

**ACTIVE:** Product device recommended for new designs.

**LIFEBUY:** TI has announced that the device will be discontinued, and a lifetime-buy period is in effect.

**NRND:** Not recommended for new designs. Device is in production to support existing customers, but TI does not recommend using this part in a new design.

**PREVIEW:** Device has been announced but is not in production. Samples may or may not be available.

**OBsolete:** TI has discontinued the production of the device.

<sup>(2)</sup> Eco Plan - The planned eco-friendly classification: Pb-Free (RoHS), Pb-Free (RoHS Exempt), or Green (RoHS & no Sb/Br) - please check <http://www.ti.com/productcontent> for the latest availability information and additional product content details.

**TBD:** The Pb-Free/Green conversion plan has not been defined.

**Pb-Free (RoHS):** TI's terms "Lead-Free" or "Pb-Free" mean semiconductor products that are compatible with the current RoHS requirements for all 6 substances, including the requirement that lead not exceed 0.1% by weight in homogeneous materials. Where designed to be soldered at high temperatures, TI Pb-Free products are suitable for use in specified lead-free processes.

**Pb-Free (RoHS Exempt):** This component has a RoHS exemption for either 1) lead-based flip-chip solder bumps used between the die and package, or 2) lead-based die adhesive used between the die and leadframe. The component is otherwise considered Pb-Free (RoHS compatible) as defined above.

**Green (RoHS & no Sb/Br):** TI defines "Green" to mean Pb-Free (RoHS compatible), and free of Bromine (Br) and Antimony (Sb) based flame retardants (Br or Sb do not exceed 0.1% by weight in homogeneous material)

<sup>(3)</sup> MSL, Peak Temp. -- The Moisture Sensitivity Level rating according to the JEDEC industry standard classifications, and peak solder temperature.

**Important Information and Disclaimer:** The information provided on this page represents TI's knowledge and belief as of the date that it is provided. TI bases its knowledge and belief on information provided by third parties, and makes no representation or warranty as to the accuracy of such information. Efforts are underway to better integrate information from third parties. TI has taken and continues to take reasonable steps to provide representative and accurate information but may not have conducted destructive testing or chemical analysis on incoming materials and chemicals. TI and TI suppliers consider certain information to be proprietary, and thus CAS numbers and other limited information may not be available for release.

In no event shall TI's liability arising out of such information exceed the total purchase price of the TI part(s) at issue in this document sold by TI to Customer on an annual basis.

**OTHER QUALIFIED VERSIONS OF TLV2462A-EP, TLV2464A-EP :**

- Catalog: [TLV2462A](#), [TLV2464A](#)

- Automotive: [TLV2462A-Q1](#), [TLV2464A-Q1](#)
- Military: [TLV2462AM](#)

## NOTE: Qualified Version Definitions:

- Catalog - TI's standard catalog product
- Automotive - Q100 devices qualified for high-reliability automotive applications targeting zero defects
- Military - QML certified for Military and Defense Applications

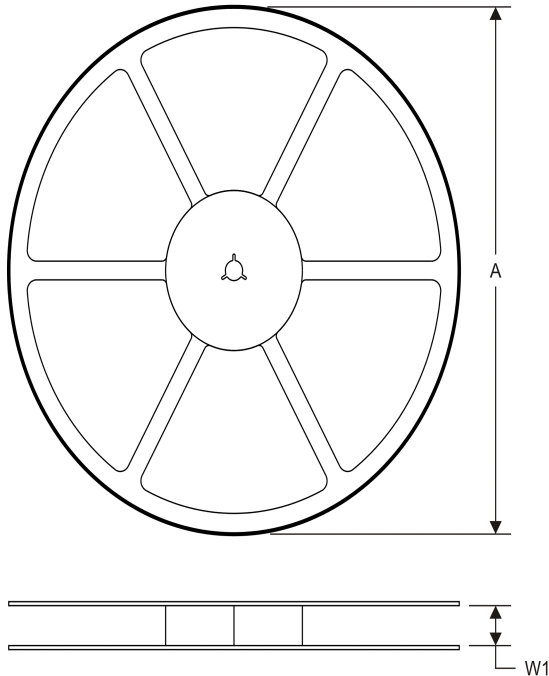
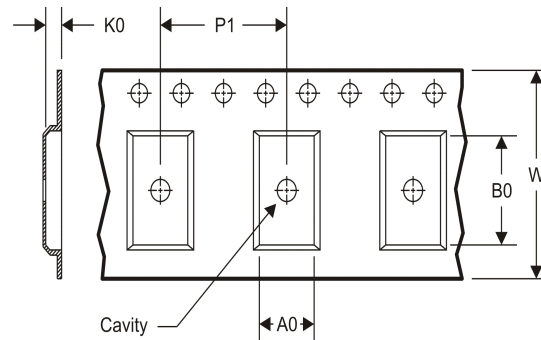
**TAPE AND REEL INFORMATION**
**REEL DIMENSIONS**

**TAPE DIMENSIONS**

A0	Dimension designed to accommodate the component width
B0	Dimension designed to accommodate the component length
K0	Dimension designed to accommodate the component thickness
W	Overall width of the carrier tape
P1	Pitch between successive cavity centers

**TAPE AND REEL INFORMATION**

\*All dimensions are nominal

Device	Package Type	Package Drawing	Pins	SPQ	Reel Diameter (mm)	Reel Width W1 (mm)	A0 (mm)	B0 (mm)	K0 (mm)	P1 (mm)	W (mm)	Pin1 Quadrant
TLV2462AMDREP	SOIC	D	8	2500	330.0	12.4	6.4	5.2	2.1	8.0	12.0	Q1
TLV2462AQDREP	SOIC	D	8	2500	330.0	12.4	6.4	5.2	2.1	8.0	12.0	Q1
TLV2464AMDREP	SOIC	D	14	2500	330.0	16.4	6.5	9.0	2.1	8.0	16.0	Q1
TLV2464AMPWREP	TSSOP	PW	14	2000	330.0	12.4	6.9	5.6	1.6	8.0	12.0	Q1

**TAPE AND REEL BOX DIMENSIONS**

\*All dimensions are nominal

Device	Package Type	Package Drawing	Pins	SPQ	Length (mm)	Width (mm)	Height (mm)
TLV2462AMDREP	SOIC	D	8	2500	367.0	367.0	35.0
TLV2462AQDREP	SOIC	D	8	2500	367.0	367.0	35.0
TLV2464AMDREP	SOIC	D	14	2500	333.2	345.9	28.6
TLV2464AMPWREP	TSSOP	PW	14	2000	367.0	367.0	35.0



## IMPORTANT NOTICE

Texas Instruments Incorporated and its subsidiaries (TI) reserve the right to make corrections, enhancements, improvements and other changes to its semiconductor products and services per JESD46C and to discontinue any product or service per JESD48B. Buyers should obtain the latest relevant information before placing orders and should verify that such information is current and complete. All semiconductor products (also referred to herein as "components") are sold subject to TI's terms and conditions of sale supplied at the time of order acknowledgment.

TI warrants performance of its components to the specifications applicable at the time of sale, in accordance with the warranty in TI's terms and conditions of sale of semiconductor products. Testing and other quality control techniques are used to the extent TI deems necessary to support this warranty. Except where mandated by applicable law, testing of all parameters of each component is not necessarily performed.

TI assumes no liability for applications assistance or the design of Buyers' products. Buyers are responsible for their products and applications using TI components. To minimize the risks associated with Buyers' products and applications, Buyers should provide adequate design and operating safeguards.

TI does not warrant or represent that any license, either express or implied, is granted under any patent right, copyright, mask work right, or other intellectual property right relating to any combination, machine, or process in which TI components or services are used. Information published by TI regarding third-party products or services does not constitute a license to use such products or services or a warranty or endorsement thereof. Use of such information may require a license from a third party under the patents or other intellectual property of the third party, or a license from TI under the patents or other intellectual property of TI.

Reproduction of significant portions of TI information in TI data books or data sheets is permissible only if reproduction is without alteration and is accompanied by all associated warranties, conditions, limitations, and notices. TI is not responsible or liable for such altered documentation. Information of third parties may be subject to additional restrictions.

Resale of TI components or services with statements different from or beyond the parameters stated by TI for that component or service voids all express and any implied warranties for the associated TI component or service and is an unfair and deceptive business practice. TI is not responsible or liable for any such statements.

Buyer acknowledges and agrees that it is solely responsible for compliance with all legal, regulatory and safety-related requirements concerning its products, and any use of TI components in its applications, notwithstanding any applications-related information or support that may be provided by TI. Buyer represents and agrees that it has all the necessary expertise to create and implement safeguards which anticipate dangerous consequences of failures, monitor failures and their consequences, lessen the likelihood of failures that might cause harm and take appropriate remedial actions. Buyer will fully indemnify TI and its representatives against any damages arising out of the use of any TI components in safety-critical applications.

In some cases, TI components may be promoted specifically to facilitate safety-related applications. With such components, TI's goal is to help enable customers to design and create their own end-product solutions that meet applicable functional safety standards and requirements. Nonetheless, such components are subject to these terms.

No TI components are authorized for use in FDA Class III (or similar life-critical medical equipment) unless authorized officers of the parties have executed a special agreement specifically governing such use.

Only those TI components which TI has specifically designated as military grade or "enhanced plastic" are designed and intended for use in military/aerospace applications or environments. Buyer acknowledges and agrees that any military or aerospace use of TI components which have **not** been so designated is solely at the Buyer's risk, and that Buyer is solely responsible for compliance with all legal and regulatory requirements in connection with such use.

TI has specifically designated certain components which meet ISO/TS16949 requirements, mainly for automotive use. Components which have not been so designated are neither designed nor intended for automotive use; and TI will not be responsible for any failure of such components to meet such requirements.

### Products

Audio	<a href="http://www.ti.com/audio">www.ti.com/audio</a>
Amplifiers	<a href="http://amplifier.ti.com">amplifier.ti.com</a>
Data Converters	<a href="http://dataconverter.ti.com">dataconverter.ti.com</a>
DLP® Products	<a href="http://www.dlp.com">www.dlp.com</a>
DSP	<a href="http://dsp.ti.com">dsp.ti.com</a>
Clocks and Timers	<a href="http://www.ti.com/clocks">www.ti.com/clocks</a>
Interface	<a href="http://interface.ti.com">interface.ti.com</a>
Logic	<a href="http://logic.ti.com">logic.ti.com</a>
Power Mgmt	<a href="http://power.ti.com">power.ti.com</a>
Microcontrollers	<a href="http://microcontroller.ti.com">microcontroller.ti.com</a>
RFID	<a href="http://www.ti-rfid.com">www.ti-rfid.com</a>
OMAP Mobile Processors	<a href="http://www.ti.com/omap">www.ti.com/omap</a>
Wireless Connectivity	<a href="http://www.ti.com/wirelessconnectivity">www.ti.com/wirelessconnectivity</a>

### Applications

Automotive and Transportation	<a href="http://www.ti.com/automotive">www.ti.com/automotive</a>
Communications and Telecom	<a href="http://www.ti.com/communications">www.ti.com/communications</a>
Computers and Peripherals	<a href="http://www.ti.com/computers">www.ti.com/computers</a>
Consumer Electronics	<a href="http://www.ti.com/consumer-apps">www.ti.com/consumer-apps</a>
Energy and Lighting	<a href="http://www.ti.com/energy">www.ti.com/energy</a>
Industrial	<a href="http://www.ti.com/industrial">www.ti.com/industrial</a>
Medical	<a href="http://www.ti.com/medical">www.ti.com/medical</a>
Security	<a href="http://www.ti.com/security">www.ti.com/security</a>
Space, Avionics and Defense	<a href="http://www.ti.com/space-avionics-defense">www.ti.com/space-avionics-defense</a>
Video and Imaging	<a href="http://www.ti.com/video">www.ti.com/video</a>

**TI E2E Community** [e2e.ti.com](http://e2e.ti.com)