

TLV277x-Q1, TLV277xA-Q1

FAMILY OF 2.7-V HIGH-SLEW-RATE RAIL-TO-RAIL OUTPUT OPERATIONAL AMPLIFIERS WITH SHUTDOWN

SGLS179D– SEPTEMBER 2003 – REVISED AUGUST 2008

- Qualified for Automotive Applications
- High Slew Rate . . . 10.5 V/ μ s Typ
- High-Gain Bandwidth . . . 5.1 MHz Typ
- Supply Voltage Range 2.5 V to 5.5 V
- Rail-to-Rail Output
- 360- μ V Input Offset Voltage
- Low Distortion Driving 600- Ω . . . 0.005% THD+N
- 1-mA Supply Current (Per Channel)
- 17-nV/ $\sqrt{\text{Hz}}$ Input Noise Voltage
- 2-pA Input Bias Current
- Characterized From $T_A = -40^\circ\text{C}$ to 125°C
- Available in MSOP and SOT-23 Packages
- Micropower Shutdown Mode . . . $I_{DD} < 1 \mu\text{A}$

description

The TLV277x CMOS operational amplifier family combines high slew rate and bandwidth, rail-to-rail output swing, high output drive, and excellent dc-precision. The device provides 10.5 V/ μ s of slew rate and 5.1 MHz of bandwidth while only consuming 1 mA of supply current per channel. This ac-performance is much higher than current competitive CMOS amplifiers. The rail-to-rail output swing and high output drive make these devices a good choice for driving the analog input or reference of analog-to-digital converters. These devices also have low distortion while driving a 600- Ω load for use in telecom systems.

These amplifiers have a 360- μ V input offset voltage, a 17 nV/ $\sqrt{\text{Hz}}$ input noise voltage, and a 2-pA input bias current for measurement, medical, and industrial applications. The TLV277x family is also specified across an extended temperature range (-40°C to 125°C), making it useful for automotive systems.

These devices operate from a 2.5-V to 5.5-V single supply voltage and are characterized at 2.7 V and 5 V. The single-supply operation and low power consumption make these devices a good solution for portable applications. The following table lists the packages available.

FAMILY PACKAGE TABLE

| DEVICE | NUMBER OF CHANNELS | PACKAGE TYPES | | | SHUTDOWN | UNIVERSAL EVM BOARD |
|---------|--------------------|---------------|-------|--------|----------|---------------------------------------|
| | | SOIC | TSSOP | SOT-23 | | |
| TLV2770 | 1 | 8 | — | — | Yes | See the EVM Selection Guide (SLOU060) |
| TLV2771 | 1 | 8 | — | 5 | — | |
| TLV2772 | 2 | 8 | 8 | — | — | |
| TLV2773 | 2 | 14 | — | — | Yes | |
| TLV2774 | 4 | 14 | 14 | — | — | |
| TLV2775 | 4 | 16 | 16 | — | Yes | |



Please be aware that an important notice concerning availability, standard warranty, and use in critical applications of Texas Instruments semiconductor products and disclaimers thereto appears at the end of this data sheet.

PRODUCTION DATA information is current as of publication date. Products conform to specifications per the terms of Texas Instruments standard warranty. Production processing does not necessarily include testing of all parameters.



POST OFFICE BOX 655303 • DALLAS, TEXAS 75265

Copyright © 2008 Texas Instruments Incorporated

TLV277x-Q1, TLV277xA-Q1

FAMILY OF 2.7-V HIGH-SLEW-RATE RAIL-TO-RAIL OUTPUT OPERATIONAL AMPLIFIERS WITH SHUTDOWN

SGLS179D – SEPTEMBER 2003 – REVISED AUGUST 2008

A SELECTION OF SINGLE-SUPPLY OPERATIONAL AMPLIFIER PRODUCTS†

| DEVICE | V _{DD} (V) | BW (MHz) | SLEW RATE (V/μs) | I _{DD} (per channel) (μA) | RAIL-TO-RAIL |
|---------|---------------------|----------|------------------|------------------------------------|--------------|
| TLV277x | 2.5 – 6 | 5.1 | 10.5 | 1000 | O |
| TLV247x | 2.7 – 6 | 2.8 | 1.5 | 600 | I/O |
| TLV245x | 2.7 – 6 | 0.22 | 0.11 | 23 | I/O |
| TLV246x | 2.7 – 6 | 6.4 | 1.6 | 550 | I/O |

† All specifications measured at 5 V.

ORDERING INFORMATION†

| T _A | V _{IOmax} AT 25°C (mV) | PACKAGE‡ | | ORDERABLE PART NUMBER | TOP-SIDE MARKING |
|----------------|---------------------------------|---------------|-----------------|-----------------------|------------------|
| –40°C to 125°C | 2.5 | SOIC (D) | Tape and reel | TLV2770QDRQ1§ | |
| | 1.6 | SOIC (D) | Tape and reel | TLV2770AQDRQ1§ | |
| | 2.5 | SOT-23 (DBV) | Tape and reel | TLV2771QDBVRQ1 | VBPQ |
| | 2.5 | SOIC (D) | Tape and reel | TLV2771QDRQ1§ | |
| | 1.6 | SOIC (D) | Tape and reel | TLV2771AQDRQ1§ | |
| | 2.5 | SOIC (D) | Tape and reel | TLV2772QDRQ1 | TLV2772QI |
| | | TSSOP (PW) | Tape and reel | TLV2772QPWRQ1 | TLV2772QI |
| | 1.6 | SOIC (D) | Tape and reel | TLV2772AQDRQ1 | TLV2772AQ |
| | | TSSOP (PW) | Tape and reel | TLV2772AQPWRQ1 | TLV2772AQ |
| | 2.5 | SOIC (D) | Tape and reel | TLV2773QDRQ1§ | |
| | 1.6 | SOIC (D) | Tape and reel | TLV2773AQDRQ1§ | |
| | 2.7 | SOIC (D) | Tape and reel | TLV2774QDRQ1§ | |
| | | TSSOP (PW) | Tape and reel | TLV2774QPWRQ1§ | |
| | 2.1 | SOIC (D) | Tape and reel | TLV2774AQDRQ1§ | |
| | | TSSOP (PW) | Tape and reel | TLV2774AQPWRQ1§ | |
| | 2.7 | SOIC (D) | Tape and reel | TLV2775QDRQ1§ | |
| | | TSSOP (PW) | Tape and reel | TLV2775QPWRQ1§ | |
| | 2.1 | SOIC (D) | Tape and reel | TLV2775AQDRQ1§ | |
| TSSOP (PW) | | Tape and reel | TLV2775AQPWRQ1§ | | |

† For the most current package and ordering information, see the Package Option Addendum at the end of this document, or see the TI web site at <http://www.ti.com>.

‡ Package drawings, thermal data, and symbolization are available at <http://www.ti.com/packaging>.

§ Product Preview



TLV277x-Q1, TLV277xA-Q1 FAMILY OF 2.7-V HIGH-SLEW-RATE RAIL-TO-RAIL OUTPUT OPERATIONAL AMPLIFIERS WITH SHUTDOWN

SGLS179D – SEPTEMBER 2003 – REVISED AUGUST 2008

TLV277x PACKAGE PINOUTS

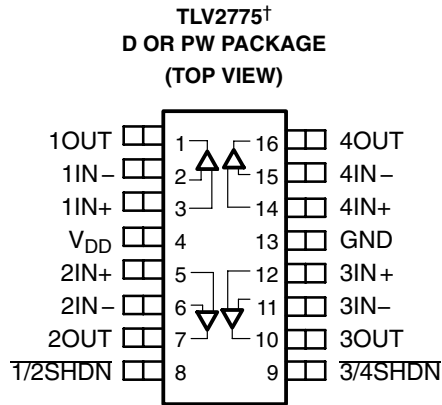
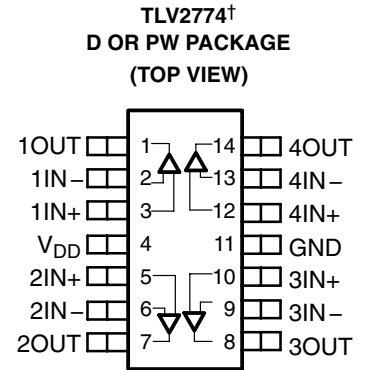
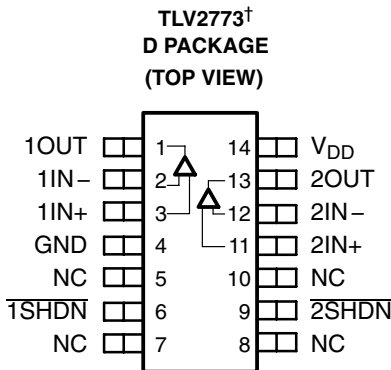
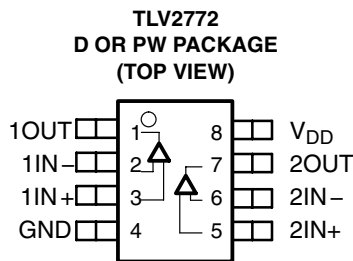
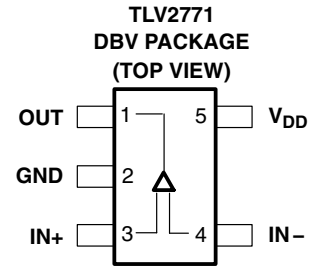
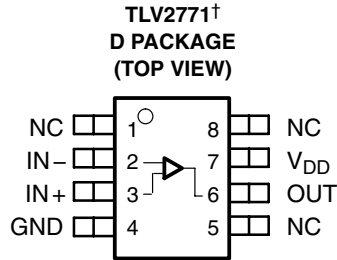
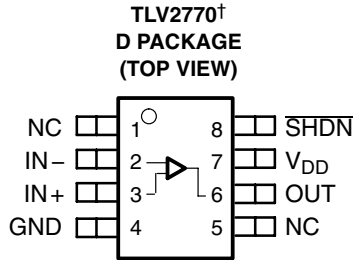

NC – No internal connection

† This device is in the Product Preview stage of development. Contact your local Texas Instruments sales office for availability.

TLV277x-Q1, TLV277xA-Q1

FAMILY OF 2.7-V HIGH-SLEW-RATE RAIL-TO-RAIL OUTPUT OPERATIONAL AMPLIFIERS WITH SHUTDOWN

SGLS179D – SEPTEMBER 2003 – REVISED AUGUST 2008

absolute maximum ratings over operating free-air temperature range (unless otherwise noted)[†]

| | |
|---|------------------------------|
| Supply voltage, V_{DD} (see Note 1) | 7 V |
| Differential input voltage, V_{ID} (see Note 2) | $\pm V_{DD}$ |
| Input voltage range, V_I (any input, see Note 1) | -0.3 V to V_{DD} |
| Input current, I_I (any input) | ± 4 mA |
| Output current, I_O | ± 50 mA |
| Total current into V_{DD+} | ± 50 mA |
| Total current out of GND | ± 50 mA |
| Duration of short-circuit current (at or below) 25°C (see Note 3) | Unlimited |
| Continuous total power dissipation | See Dissipation Rating Table |
| Operating free-air temperature range, T_A : Q suffix | -40°C to 125°C |
| Storage temperature range, T_{stg} | -65°C to 150°C |
| Lead temperature 1,6 mm (1/16 inch) from case for 10 seconds | 260°C |

[†] Stresses beyond those listed under “absolute maximum ratings” may cause permanent damage to the device. These are stress ratings only, and functional operation of the device at these or any other conditions beyond those indicated under “recommended operating conditions” is not implied. Exposure to absolute-maximum-rated conditions for extended periods may affect device reliability.

- NOTES:
1. All voltage values, except differential voltages, are with respect to GND.
 2. Differential voltages are at the noninverting input with respect to the inverting input. Excessive current flows when input is brought below GND - 0.3 V.
 3. The output may be shorted to either supply. Temperature and/or supply voltages must be limited to ensure that the maximum dissipation rating is not exceeded.

ESD RATING TABLE

| | | | |
|------------|-------------------------------------|----------|----|
| ESD rating | Human Body Model ⁽⁴⁾ | 2 (H1C) | kV |
| | Charged-Device Model ⁽⁴⁾ | 1 (C5) | |
| | Machine Model ⁽⁴⁾ | 150 (M2) | V |
| | Machine Model ⁽⁵⁾ | 100 (M1) | V |

NOTE 4: ESD protection level per AEC Q100 Classification TLV2771QDBVRQ1

NOTE 5: ESD protection level per AEC Q100 Classification TLV2772QPWRG4Q1

DISSIPATION RATING TABLE

| PACKAGE | $T_A \leq 25^\circ\text{C}$ POWER RATING | DERATING FACTOR ABOVE $T_A = 25^\circ\text{C}$ | $T_A = 70^\circ\text{C}$ POWER RATING | $T_A = 85^\circ\text{C}$ POWER RATING | $T_A = 125^\circ\text{C}$ POWER RATING |
|---------|---|---|--|--|---|
| D | 725 mW | 5.8 mW/°C | 464 mW | 377 mW | 145 mW |
| DBV | 437 mW | 3.5 mW/°C | 280 mW | 227 mW | 87 mW |
| PW | 700 mW | 5.6 mW/°C | 448 mW | 364 mW | 140 mW |

recommended operating conditions

| | Q SUFFIX | | UNIT |
|---------------------------------------|----------|-----------------|------|
| | MIN | MAX | |
| Supply voltage, V_{DD} | 2.5 | 6 | V |
| Input voltage range, V_I | GND | $V_{DD+} - 1.3$ | V |
| Common-mode input voltage, V_{IC} | GND | $V_{DD+} - 1.3$ | V |
| Operating free-air temperature, T_A | -40 | 125 | °C |



TLV277x-Q1, TLV277xA-Q1
FAMILY OF 2.7-V HIGH-SLEW-RATE RAIL-TO-RAIL OUTPUT
OPERATIONAL AMPLIFIERS WITH SHUTDOWN

SGLS179D – SEPTEMBER 2003 – REVISED AUGUST 2008

electrical characteristics at specified free-air temperature, $V_{DD} = 2.7\text{ V}$ (unless otherwise noted)

| PARAMETER | TEST CONDITIONS | T_A^\dagger | TLV2771-Q1 | | | UNIT |
|--|--|---------------|------------|------------------------------|------|------|
| | | | MIN | TYP | MAX | |
| V_{IO} Input offset voltage | $V_{IC} = 0, V_O = 0, R_S = 50\ \Omega$ $V_{DD} = \pm 1.35\text{ V}$, No load | 25°C | 0.48 | 2.5 | mV | |
| | | Full range | 0.53 | 2.7 | | |
| α_{VIO} Temperature coefficient of input offset voltage | $V_{IC} = 0, V_O = 0, R_S = 50\ \Omega$ | 25°C to 125°C | 2 | $\mu\text{V}/^\circ\text{C}$ | | |
| I_{IO} Input offset current | | 25°C | 1 | 60 | pA | |
| | | Full range | 2 | 125 | | |
| I_{IB} Input bias current | | 25°C | 2 | 60 | pA | |
| | Full range | 6 | 350 | | | |
| V_{OH} High-level output voltage | $I_{OH} = -0.675\text{ mA}$ | 25°C | 2.6 | V | | |
| | | Full range | 2.5 | | | |
| | $I_{OH} = -2.2\text{ mA}$ | 25°C | 2.4 | | | |
| | | Full range | 2.1 | | | |
| V_{OL} Low-level output voltage | $V_{IC} = 1.35\text{ V}, I_{OL} = 0.675\text{ mA}$ | 25°C | 0.1 | V | | |
| | | Full range | 0.2 | | | |
| | $V_{IC} = 1.35\text{ V}, I_{OL} = 2.2\text{ mA}$ | 25°C | 0.21 | | | |
| | | Full range | 0.6 | | | |
| A_{VD} Large-signal differential voltage amplification | $V_{IC} = 1.35\text{ V}, R_L = 10\text{ k}\Omega^\ddagger$, $V_O = 0.6\text{ V}$ to 2.1 V | 25°C | 20 | 380 | V/mV | |
| | | Full range | 13 | | | |
| $r_{i(d)}$ Differential input resistance | | 25°C | 10^{12} | Ω | | |
| $C_{i(c)}$ Common-mode input capacitance | $f = 10\text{ kHz}$ | 25°C | 8 | pF | | |
| Z_o Closed-loop output impedance | $f = 100\text{ kHz}, A_V = 10$ | 25°C | 25 | Ω | | |
| CMRR Common-mode rejection ratio | $V_{IC} = 0$ to $1.5\text{ V}, V_O = V_{DD}/2$, $R_S = 50\ \Omega$ | 25°C | 60 | 84 | dB | |
| | | Full range | 60 | 82 | | |
| k_{SVR} Supply voltage rejection ratio ($\Delta V_{DD} / \Delta V_{IO}$) | $V_{DD} = 2.7\text{ V}$ to $5\text{ V}, V_{IC} = V_{DD}/2$, No load | 25°C | 70 | 89 | dB | |
| | | Full range | 70 | 84 | | |
| I_{DD} Supply current (per channel) | $V_O = V_{DD}/2$, No load | 25°C | 1 | 2 | mA | |
| | | Full range | | 2 | | |

† Full range is -40°C to 125°C for Q level part.

‡ Referenced to 1.35 V

TLV277x-Q1, TLV277xA-Q1
FAMILY OF 2.7-V HIGH-SLEW-RATE RAIL-TO-RAIL OUTPUT
OPERATIONAL AMPLIFIERS WITH SHUTDOWN

SGLS179D – SEPTEMBER 2003 – REVISED AUGUST 2008

operating characteristics at specified free-air temperature, $V_{DD} = 2.7\text{ V}$ (unless otherwise noted)

| PARAMETER | TEST CONDITIONS | T_A † | TLV2771-Q1 | | | UNIT |
|---|---|-------------|------------|-------|------------------------|---------|
| | | | MIN | TYP | MAX | |
| SR Slew rate at unity gain | $V_{O(PP)} = 0.8\text{ V}$, $C_L = 100\text{ pF}$, $R_L = 10\text{ k}\Omega$ | 25°C | 5 | 9 | V/ μ s | |
| | | Full range | 4.7 | 6 | | |
| V_n Equivalent input noise voltage | $f = 1\text{ kHz}$ | 25°C | 21 | | nV/ $\sqrt{\text{Hz}}$ | |
| | $f = 10\text{ kHz}$ | 25°C | 17 | | | |
| $V_{N(PP)}$ Peak-to-peak equivalent input noise voltage | $f = 0.1\text{ Hz to }1\text{ Hz}$ | 25°C | 0.33 | | μ V | |
| | $f = 0.1\text{ Hz to }10\text{ Hz}$ | 25°C | 0.86 | | μ V | |
| I_n Equivalent input noise current | $f = 100\text{ Hz}$ | 25°C | 0.6 | | fA/ $\sqrt{\text{Hz}}$ | |
| THD + N Total harmonic distortion plus noise | $R_L = 600\ \Omega$, $f = 1\text{ kHz}$ | $A_V = 1$ | 0.0085% | | | |
| | | $A_V = 10$ | 0.025% | | | |
| | | $A_V = 100$ | 0.12% | | | |
| Gain-bandwidth product | $f = 10\text{ kHz}$, $R_L = 600\ \Omega$, $C_L = 100\text{ pF}$ | 25°C | 4.8 | | MHz | |
| t_s Settling time | $A_V = -1$, Step = 0.85 V to 1.85 V, $R_L = 600\ \Omega$, $C_L = 100\text{ pF}$ | 0.1% | 25°C | 0.186 | | μ s |
| | | 0.01% | 25°C | 3.92 | | |
| ϕ_m Phase margin at unity gain | $R_L = 600\ \Omega$, $C_L = 100\text{ pF}$ | 25°C | 46° | | | |
| Gain margin | | 25°C | 12 | | dB | |

† Full range is -40°C to 125°C .



TLV277x-Q1, TLV277xA-Q1
FAMILY OF 2.7-V HIGH-SLEW-RATE RAIL-TO-RAIL OUTPUT
OPERATIONAL AMPLIFIERS WITH SHUTDOWN

SGLS179D – SEPTEMBER 2003 – REVISED AUGUST 2008

electrical characteristics at specified free-air temperature, $V_{DD} = 5\text{ V}$ (unless otherwise noted)

| PARAMETER | TEST CONDITIONS | T_A^\dagger | TLV2771-Q1 | | | UNIT |
|--|---|---------------|------------|-----|------------------------------|------|
| | | | MIN | TYP | MAX | |
| V_{IO} Input offset voltage | $V_{IC} = 0$, No load $V_O = 0$, $R_S = 50\ \Omega$, $V_{DD} = \pm 2.5\text{ V}$ | 25°C | 0.5 | 2.5 | mV | |
| | | Full range | 0.6 | 2.7 | | |
| α_{VIO} Temperature coefficient of input offset voltage | $V_{IC} = 0$, $V_O = 0$, $R_S = 50\ \Omega$, $V_{DD} = \pm 2.5\text{ V}$ | 25°C to 125°C | 2 | | $\mu\text{V}/^\circ\text{C}$ | |
| I_{IO} Input offset current | | 25°C | 1 | 60 | pA | |
| | | Full range | 2 | 125 | | |
| I_{IB} Input bias current | | 25°C | 2 | 60 | pA | |
| | Full range | 6 | 350 | | | |
| V_{OH} High-level output voltage | $I_{OH} = -1.3\text{ mA}$ | 25°C | 4.9 | | V | |
| | | Full range | 4.8 | | | |
| | $I_{OH} = -4.2\text{ mA}$ | 25°C | 4.7 | | | |
| | | Full range | 4.4 | | | |
| V_{OL} Low-level output voltage | $V_{IC} = 2.5\text{ V}$, $I_{OL} = 1.3\text{ mA}$ | 25°C | 0.1 | | V | |
| | | Full range | 0.2 | | | |
| | $V_{IC} = 2.5\text{ V}$, $I_{OL} = 4.2\text{ mA}$ | 25°C | 0.21 | | | |
| | | Full range | 0.6 | | | |
| A_{VD} Large-signal differential voltage amplification | $V_{IC} = 2.5\text{ V}$, $R_L = 10\text{ k}\Omega^\ddagger$, $V_O = 1\text{ V to }4\text{ V}$ | 25°C | 20 | 450 | V/mV | |
| | | Full range | 13 | | | |
| $r_{i(d)}$ Differential input resistance | | 25°C | 10^{12} | | Ω | |
| $c_{i(c)}$ Common-mode input capacitance | $f = 10\text{ kHz}$ | 25°C | 8 | | pF | |
| z_o Closed-loop output impedance | $f = 100\text{ kHz}$, $A_V = 10$ | 25°C | 20 | | Ω | |
| CMRR Common-mode rejection ratio | $V_{IC} = 0\text{ to }3.7\text{ V}$, $V_O = V_{DD}/2$, $R_S = 50\ \Omega$ | 25°C | 60 | 96 | dB | |
| | | Full range | 60 | 93 | | |
| k_{SVR} Supply voltage rejection ratio ($\Delta V_{DD} / \Delta V_{IO}$) | $V_{DD} = 2.7\text{ V to }5\text{ V}$, $V_{IC} = V_{DD}/2$, No load | 25°C | 70 | 89 | dB | |
| | | Full range | 70 | 84 | | |
| I_{DD} Supply current (per channel) | $V_O = V_{DD}/2$, No load | 25°C | 1 | 2 | mA | |
| | | Full range | 2 | | | |

† Full range is -40°C to 125°C for Q level part.

‡ Referenced to 2.5 V

TLV277x-Q1, TLV277xA-Q1

FAMILY OF 2.7-V HIGH-SLEW-RATE RAIL-TO-RAIL OUTPUT OPERATIONAL AMPLIFIERS WITH SHUTDOWN

SGLS179D – SEPTEMBER 2003 – REVISED AUGUST 2008

operating characteristics at specified free-air temperature, $V_{DD} = 5\text{ V}$ (unless otherwise noted)

| PARAMETER | TEST CONDITIONS | T_A^\dagger | TLV2771-Q1 | | | UNIT |
|---|---|---------------|------------|--------|-----|------------------------|
| | | | MIN | TYP | MAX | |
| SR Slew rate at unity gain | $V_{O(PP)} = 1.5\text{ V}$, $C_L = 100\text{ pF}$, $R_L = 10\text{ k}\Omega$ | 25°C | 5 | 10.5 | | V/ μ s |
| | | Full range | 4.7 | 6 | | |
| V_n Equivalent input noise voltage | $f = 1\text{ kHz}$ | 25°C | | 17 | | nV/ $\sqrt{\text{Hz}}$ |
| | $f = 10\text{ kHz}$ | 25°C | | 12 | | |
| $V_{N(PP)}$ Peak-to-peak equivalent input noise voltage | $f = 0.1\text{ Hz to }1\text{ Hz}$ | 25°C | | 0.33 | | μ V |
| | $f = 0.1\text{ Hz to }10\text{ Hz}$ | 25°C | | 0.86 | | μ V |
| I_n Equivalent input noise current | $f = 100\text{ Hz}$ | 25°C | | 0.6 | | fA/ $\sqrt{\text{Hz}}$ |
| THD + N Total harmonic distortion plus noise | $R_L = 600\ \Omega$, $f = 1\text{ kHz}$ | $A_V = 1$ | 25°C | 0.005% | | |
| | | $A_V = 10$ | | 0.016% | | |
| | | $A_V = 100$ | | 0.095% | | |
| Gain-bandwidth product | $f = 10\text{ kHz}$, $R_L = 600\ \Omega$, $C_L = 100\text{ pF}$ | 25°C | | 5.1 | | MHz |
| t_s Settling time | $A_V = -1$, Step = 1.5 V to 3.5 V, $R_L = 600\ \Omega$, $C_L = 100\text{ pF}$ | 0.1% | 25°C | 0.134 | | μ s |
| | | 0.01% | 25°C | 1.97 | | |
| ϕ_m Phase margin at unity gain | $R_L = 600\ \Omega$, $C_L = 100\text{ pF}$ | 25°C | | 46° | | |
| Gain margin | | 25°C | | 12 | | dB |

† Full range is -40°C to 125°C .

TLV277x-Q1, TLV277xA-Q1
FAMILY OF 2.7-V HIGH-SLEW-RATE RAIL-TO-RAIL OUTPUT
OPERATIONAL AMPLIFIERS WITH SHUTDOWN

SGLS179D– SEPTEMBER 2003 – REVISED AUGUST 2008

electrical characteristics at specified free-air temperature, $V_{DD} = 2.7\text{ V}$ (unless otherwise noted)

| PARAMETER | TEST CONDITIONS | T_A^\dagger | TLV2772-Q1 | | | TLV2772A-Q1 | | | UNIT |
|--|--|-------------------------------------|------------|-------------|-----|-------------|-------------|------------------------------|------|
| | | | MIN | TYP | MAX | MIN | TYP | MAX | |
| V_{IO} Input offset voltage | $V_{DD} = \pm 1.35\text{ V}$, $V_{IC} = 0$, $R_S = 50\ \Omega$ | 25°C | 0.44 | 2.5 | | 0.44 | 1.6 | mV | |
| | | Full range | 0.47 | 2.7 | | 0.47 | 1.9 | | |
| α_{VIO} Temperature coefficient of input offset voltage | | 25°C to 125°C | 2 | | | 2 | | $\mu\text{V}/^\circ\text{C}$ | |
| I_{IO} Input offset current | | 25°C | 1 | 60 | | 1 | 60 | pA | |
| | | Full range | 2 | 125 | | 2 | 125 | | |
| I_{IB} Input bias current | | 25°C | 2 | 60 | | 2 | 60 | pA | |
| | Full range | 6 | 350 | | 6 | 350 | | | |
| V_{ICR} Common-mode input voltage range | CMRR > 60 dB, $R_S = 50\ \Omega$ | 25°C | 0 to 1.4 | -0.3 to 1.7 | | 0 to 1.4 | -0.3 to 1.7 | V | |
| | | Full range | 0 to 1.4 | -0.3 to 1.7 | | 0 to 1.4 | -0.3 to 1.7 | | |
| V_{OH} High-level output voltage | $I_{OH} = -0.675\text{ mA}$ | 25°C | 2.6 | | | 2.6 | | V | |
| | | Full range | 2.45 | | | 2.45 | | | |
| | $I_{OH} = -2.2\text{ mA}$ | 25°C | 2.4 | | | 2.4 | | | |
| V_{OL} Low-level output voltage | $V_{IC} = 1.35\text{ V}$, $I_{OL} = 0.675\text{ mA}$ | 25°C | 0.1 | | | 0.1 | | V | |
| | | Full range | 0.2 | | | 0.2 | | | |
| | $V_{IC} = 1.35\text{ V}$, $I_{OL} = 2.2\text{ mA}$ | 25°C | 0.21 | | | 0.21 | | | |
| | | Full range | 0.6 | | | 0.6 | | | |
| A_{VD} Large-signal differential voltage amplification | $V_{IC} = 1.35\text{ V}$, $V_O = 0.6\text{ V to }2.1\text{ V}$ | $R_L = 10\text{ k}\Omega, \ddagger$ | 25°C | 20 | 380 | 20 | 380 | V/mV | |
| | | | Full range | 13 | | | 13 | | |
| $r_{i(d)}$ Differential input resistance | | 25°C | 10^{12} | | | 10^{12} | | Ω | |
| $C_{i(c)}$ Common-mode input capacitance | $f = 10\text{ kHz}$, | 25°C | 8 | | | 8 | | pF | |
| z_o Closed-loop output impedance | $f = 100\text{ kHz}$, $A_V = 10$ | 25°C | 25 | | | 25 | | Ω | |
| CMRR Common-mode rejection ratio | $V_{IC} = V_{ICR}(\text{min})$, $R_S = 50\ \Omega$ | $V_O = 1.5\text{ V}$, | 25°C | 60 | 84 | 60 | 84 | dB | |
| | | | Full range | 60 | 82 | 60 | 82 | | |
| k_{SVR} Supply voltage rejection ratio ($\Delta V_{DD} / \Delta V_{IO}$) | $V_{DD} = 2.7\text{ V to }5\text{ V}$, No load | $V_{IC} = V_{DD}/2$, | 25°C | 70 | 89 | 70 | 89 | dB | |
| | | | Full range | 70 | 84 | 70 | 84 | | |
| I_{DD} Supply current (per channel) | $V_O = 1.5\text{ V}$, No load | 25°C | 1 | 2 | | 1 | 2 | mA | |
| | | Full range | 2 | | | 2 | | | |

† Full range is -40°C to 125°C for Q level part.

‡ Referenced to 1.35 V

TLV277x-Q1, TLV277xA-Q1
FAMILY OF 2.7-V HIGH-SLEW-RATE RAIL-TO-RAIL OUTPUT
OPERATIONAL AMPLIFIERS WITH SHUTDOWN

SGLS179D – SEPTEMBER 2003 – REVISED AUGUST 2008

operating characteristics at specified free-air temperature, $V_{DD} = 2.7\text{ V}$ (unless otherwise noted)

| PARAMETER | TEST CONDITIONS | T_A † | TLV2772-Q1 | | | TLV2772A-Q1 | | | UNIT |
|-------------|--|---|-------------------------------|------|------|-------------|-----|---------|------------------------------|
| | | | MIN | TYP | MAX | MIN | TYP | MAX | |
| SR | Slew rate at unity gain $V_{O(PP)} = 0.8\text{ V}$, $R_L = 10\text{ k}\Omega$ | $C_L = 100\text{ pF}$ | 25°C | 5 | 9 | | 5 | 9 | $\text{V}/\mu\text{s}$ |
| | | | Full range | 4.7 | 6 | | 4.7 | 6 | |
| V_n | Equivalent input noise voltage | | 25°C | | 21 | | | 21 | $\text{nV}/\sqrt{\text{Hz}}$ |
| | | | 25°C | | 17 | | | 17 | |
| $V_{N(PP)}$ | Peak-to-peak equivalent input noise voltage | | 25°C | | 0.33 | | | 0.33 | μV |
| | | | 25°C | | 0.86 | | | 0.86 | μV |
| I_n | Equivalent input noise current | $f = 100\text{ Hz}$ | 25°C | | 0.6 | | | 0.6 | $\text{fA}/\sqrt{\text{Hz}}$ |
| THD + N | Total harmonic distortion plus noise | $R_L = 600\ \Omega$, $f = 1\text{ kHz}$ | $A_V = 1$ | 25°C | | 0.0085% | | 0.0085% | |
| | | | $A_V = 10$ | | | 0.025% | | 0.025% | |
| | | | $A_V = 100$ | | | 0.12% | | 0.12% | |
| | Gain-bandwidth product | $f = 10\text{ kHz}$, $C_L = 100\text{ pF}$ | $R_L = 600\ \Omega$, 25°C | | 4.8 | | | 4.8 | MHz |
| t_s | Settling time | $A_V = -1$, Step = 0.85 V to 1.85 V, $R_L = 600\ \Omega$, $C_L = 100\text{ pF}$ | 0.1% | 25°C | | 0.186 | | 0.186 | μs |
| | | | 0.01% | 25°C | | 3.92 | | 3.92 | |
| ϕ_m | Phase margin at unity gain | $R_L = 600\ \Omega$, $C_L = 100\text{ pF}$ | 25°C | | 46° | | | 46° | |
| | Gain margin | | 25°C | | 12 | | | 12 | |

† Full range is -40°C to 125°C for Q level part.



TLV277x-Q1, TLV277xA-Q1
FAMILY OF 2.7-V HIGH-SLEW-RATE RAIL-TO-RAIL OUTPUT
OPERATIONAL AMPLIFIERS WITH SHUTDOWN

SGLS179D– SEPTEMBER 2003 – REVISED AUGUST 2008

electrical characteristics at specified free-air temperature, $V_{DD} = 5\text{ V}$ (unless otherwise noted)

| PARAMETER | TEST CONDITIONS | T_A^\dagger | TLV2772-Q1 | | | TLV2772A-Q1 | | | UNIT |
|--|--|-------------------------------------|------------|-------------|-----|-------------|-------------|-----|------------------------------|
| | | | MIN | TYP | MAX | MIN | TYP | MAX | |
| V_{IO} Input offset voltage | $V_{DD} = \pm 2.5\text{ V}$, $V_{IC} = 0$, $V_O = 0$, $R_S = 50\ \Omega$ | 25°C | 0.36 | 2.5 | | 0.36 | 1.6 | mV | |
| | | Full range | 0.4 | 2.7 | | 0.4 | 1.9 | | |
| α_{VIO} Temperature coefficient of input offset voltage | | 25°C to 125°C | 2 | | | 2 | | | $\mu\text{V}/^\circ\text{C}$ |
| I_{IO} Input offset current | | 25°C | 1 | 60 | | 1 | 60 | pA | |
| | | Full range | 2 | 125 | | 2 | 125 | | |
| I_{IB} Input bias current | | 25°C | 2 | 60 | | 2 | 60 | pA | |
| | Full range | 6 | 350 | | 6 | 350 | | | |
| V_{ICR} Common-mode input voltage range | CMRR > 60 dB, $R_S = 50\ \Omega$ | 25°C | 0 to 3.7 | -0.3 to 3.8 | | 0 to 3.7 | -0.3 to 3.8 | V | |
| | | Full range | 0 to 3.7 | -0.3 to 3.8 | | 0 to 3.7 | -0.3 to 3.8 | | |
| V_{OH} High-level output voltage | $I_{OH} = -1.3\text{ mA}$ | 25°C | 4.9 | | | 4.9 | | | V |
| | | Full range | 4.8 | | | 4.8 | | | |
| | $I_{OH} = -4.2\text{ mA}$ | 25°C | 4.7 | | | 4.7 | | | |
| | | Full range | 4.4 | | | 4.4 | | | |
| V_{OL} Low-level output voltage | $V_{IC} = 2.5\text{ V}$, $I_{OL} = 1.3\text{ mA}$ | 25°C | 0.1 | | | 0.1 | | | V |
| | | Full range | 0.2 | | | 0.2 | | | |
| | $V_{IC} = 2.5\text{ V}$, $I_{OL} = 4.2\text{ mA}$ | 25°C | 0.21 | | | 0.21 | | | |
| | | Full range | 0.6 | | | 0.6 | | | |
| A_{VD} Large-signal differential voltage amplification | $V_{IC} = 2.5\text{ V}$, $V_O = 1\text{ V to }4\text{ V}$ | $R_L = 10\text{ k}\Omega, \ddagger$ | 25°C | 20 | 450 | | 20 | 450 | V/mV |
| | | | Full range | 13 | | | 13 | | |
| $r_{i(d)}$ Differential input resistance | | 25°C | 10^{12} | | | 10^{12} | | | Ω |
| $C_{i(c)}$ Common-mode input capacitance | $f = 10\text{ kHz}$ | 25°C | 8 | | | 8 | | | pF |
| z_o Closed-loop output impedance | $f = 100\text{ kHz}$, $A_V = 10$ | 25°C | 20 | | | 20 | | | Ω |
| CMRR Common-mode rejection ratio | $V_{IC} = V_{ICR}(\text{min})$, $R_S = 50\ \Omega$ | $V_O = 3.7\text{ V}$ | 25°C | 60 | 96 | | 60 | 96 | dB |
| | | | Full range | 60 | 93 | | 60 | 93 | |
| k_{SVR} Supply voltage rejection ratio ($\Delta V_{DD} / \Delta V_{IO}$) | $V_{DD} = 2.7\text{ V to }5\text{ V}$, No load | $V_{IC} = V_{DD}/2$ | 25°C | 70 | 89 | | 70 | 89 | dB |
| | | | Full range | 70 | 84 | | 70 | 84 | |
| I_{DD} Supply current (per channel) | $V_O = 1.5\text{ V}$, No load | 25°C | 1 | 2 | | 1 | 2 | mA | |
| | | Full range | | 2 | | | 2 | | |

† Full range is -40°C to 125°C for Q level part.

‡ Referenced to 2.5 V

TLV277x-Q1, TLV277xA-Q1

FAMILY OF 2.7-V HIGH-SLEW-RATE RAIL-TO-RAIL OUTPUT OPERATIONAL AMPLIFIERS WITH SHUTDOWN

SGLS179D – SEPTEMBER 2003 – REVISED AUGUST 2008

operating characteristics at specified free-air temperature, $V_{DD} = 5\text{ V}$ (unless otherwise noted)

| PARAMETER | TEST CONDITIONS | T_A † | TLV2772-Q1 | | | TLV2772A-Q1 | | | UNIT | |
|-------------|--|---|-------------------------------|-------------|------|-------------|--------|------|------------------------------|---------------|
| | | | MIN | TYP | MAX | MIN | TYP | MAX | | |
| SR | Slew rate at unity gain $V_{O(PP)} = 1.5\text{ V}$, $R_L = 10\text{ k}\Omega$ | $C_L = 100\text{ pF}$ | 25°C | 5 | 10.5 | | 5 | 10.5 | $\text{V}/\mu\text{s}$ | |
| | | | Full range | 4.7 | 6 | | 4.7 | 6 | | |
| V_n | Equivalent input noise voltage | | 25°C | | 17 | | | 17 | $\text{nV}/\sqrt{\text{Hz}}$ | |
| | | | 25°C | | 12 | | | 12 | | |
| $V_{N(PP)}$ | Peak-to-peak equivalent input noise voltage | | 25°C | | 0.33 | | | 0.33 | μV | |
| | | | 25°C | | 0.86 | | | 0.86 | μV | |
| I_n | Equivalent input noise current | $f = 100\text{ Hz}$ | 25°C | | 0.6 | | | 0.6 | $\text{fA}/\sqrt{\text{Hz}}$ | |
| THD + N | Total harmonic distortion plus noise | $R_L = 600\ \Omega$, $f = 1\text{ kHz}$ | 25°C | $A_V = 1$ | | | 0.005% | | 0.005% | |
| | | | | $A_V = 10$ | | | 0.016% | | 0.016% | |
| | | | | $A_V = 100$ | | | 0.095% | | 0.095% | |
| | Gain-bandwidth product | $f = 10\text{ kHz}$, $C_L = 100\text{ pF}$ | $R_L = 600\ \Omega$, 25°C | | 5.1 | | | 5.1 | MHz | |
| t_s | Settling time | $A_V = -1$, Step = 1.5 V to 3.5 V, $R_L = 600\ \Omega$, $C_L = 100\text{ pF}$ | 25°C | 0.1% | | | 0.134 | | 0.134 | μs |
| | | | 25°C | 0.01% | | | 1.97 | | 1.97 | |
| ϕ_m | Phase margin at unity gain | $R_L = 600\ \Omega$, $C_L = 100\text{ pF}$ | 25°C | | 46° | | | 46° | | |
| | Gain margin | | 25°C | | 12 | | | 12 | dB | |

† Full range is -40°C to 125°C for Q level part.

TLV277x-Q1, TLV277xA-Q1
FAMILY OF 2.7-V HIGH-SLEW-RATE RAIL-TO-RAIL OUTPUT
OPERATIONAL AMPLIFIERS WITH SHUTDOWN

SGLS179D – SEPTEMBER 2003 – REVISED AUGUST 2008

TYPICAL CHARACTERISTICS

Table of Graphs

| | | FIGURE | |
|-----------------|--|-----------------------------------|-------------------------|
| V_{IO} | Input offset voltage | Distribution | 1, 2 |
| | | vs Common-mode input voltage | 3, 4 |
| | | Distribution | 5, 6 |
| I_{IB}/I_{IO} | Input bias and input offset currents | vs Free-air temperature | 7 |
| V_{OH} | High-level output voltage | vs High-level output current | 8, 9 |
| V_{OL} | Low-level output voltage | vs Low-level output current | 10, 11 |
| $V_{O(PP)}$ | Maximum peak-to-peak output voltage | vs Frequency | 12, 13 |
| I_{OS} | Short-circuit output current | vs Supply voltage | 14 |
| | | vs Free-air temperature | 15 |
| V_O | Output voltage | vs Differential input voltage | 16 |
| A_{VD} | Large-signal differential voltage amplification and phase margin | vs Frequency | 17, 18 |
| A_{VD} | Differential voltage amplification | vs Load resistance | 19 |
| | | vs Free-air temperature | 20, 21 |
| z_o | Output impedance | vs Frequency | 22, 23 |
| CMRR | Common-mode rejection ratio | vs Frequency | 24 |
| | | vs Free-air temperature | 25 |
| k_{SVR} | Supply-voltage rejection ratio | vs Frequency | 26, 27 |
| I_{DD} | Supply current (per channel) | vs Supply voltage | 28 |
| SR | Slew rate | vs Load capacitance | 29 |
| | | vs Free-air temperature | 30 |
| V_O | Voltage-follower small-signal pulse response | | 31, 32 |
| V_O | Voltage-follower large-signal pulse response | | 33, 34 |
| V_O | Inverting small-signal pulse response | | 35, 36 |
| V_O | Inverting large-signal pulse response | | 37, 38 |
| V_n | Equivalent input noise voltage | vs Frequency | 39, 40 |
| | | Noise voltage (referred to input) | Over a 10-second period |
| THD + N | Total harmonic distortion plus noise | vs Frequency | 42, 43 |
| | | Gain-bandwidth product | vs Supply voltage |
| B_1 | Unity-gain bandwidth | vs Load capacitance | 44 |
| ϕ_m | Phase margin | vs Load capacitance | 45 |
| | | Gain margin | vs Load capacitance |
| | Amplifier with shutdown pulse turnon/off characteristics | | 48–50 |
| | Supply current with shutdown pulse turnon/off characteristics | | 51–53 |
| | Shutdown supply current | vs Free-air temperature | 54 |
| | Shutdown forward/reverse isolation | vs Frequency | 55, 56 |

TLV277x-Q1, TLV277xA-Q1
FAMILY OF 2.7-V HIGH-SLEW-RATE RAIL-TO-RAIL OUTPUT
OPERATIONAL AMPLIFIERS WITH SHUTDOWN

SGLS179D – SEPTEMBER 2003 – REVISED AUGUST 2008

TYPICAL CHARACTERISTICS

DISTRIBUTION OF TLV2772
INPUT OFFSET VOLTAGE

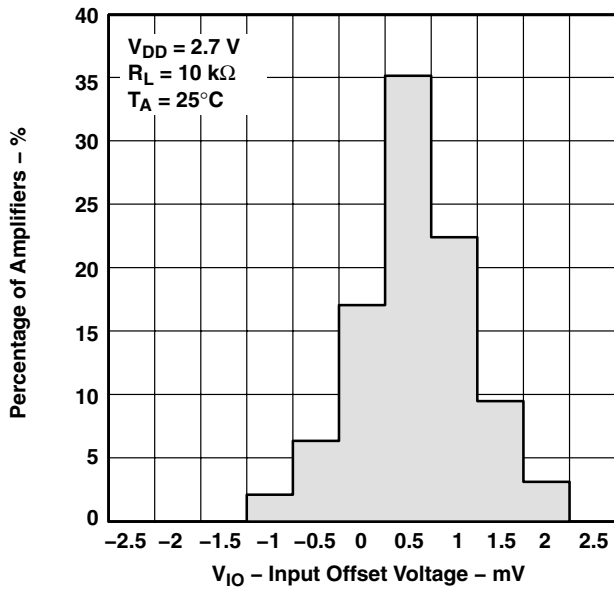

Figure 1

DISTRIBUTION OF TLV2772
INPUT OFFSET VOLTAGE

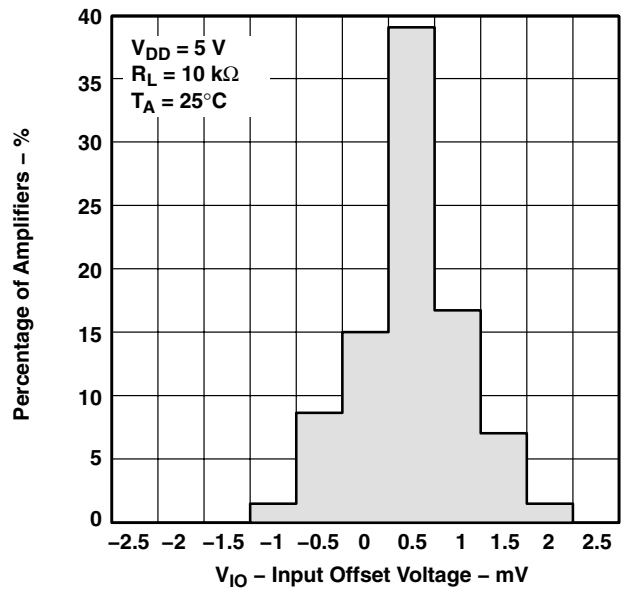

Figure 2

INPUT OFFSET VOLTAGE
vs
COMMON-MODE INPUT VOLTAGE

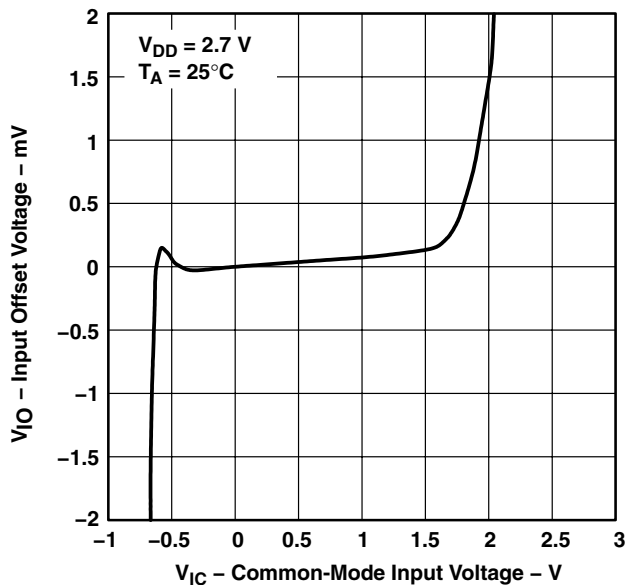

Figure 3

INPUT OFFSET VOLTAGE
vs
COMMON-MODE INPUT VOLTAGE

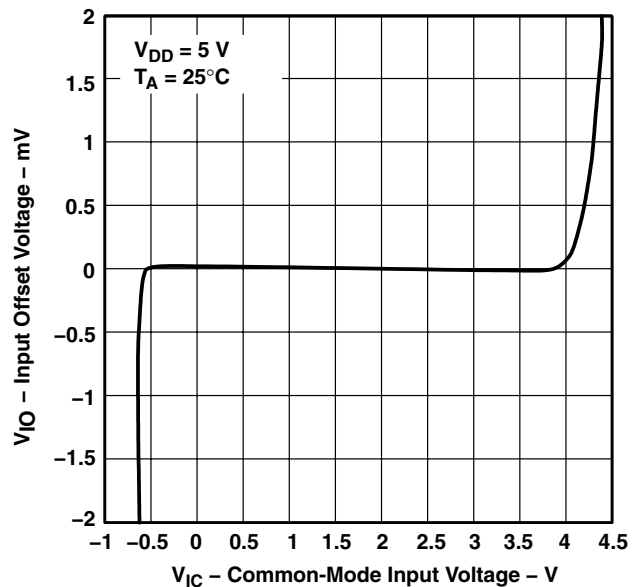

Figure 4



TLV277x-Q1, TLV277xA-Q1
FAMILY OF 2.7-V HIGH-SLEW-RATE RAIL-TO-RAIL OUTPUT
OPERATIONAL AMPLIFIERS WITH SHUTDOWN

SGLS179D – SEPTEMBER 2003 – REVISED AUGUST 2008

TYPICAL CHARACTERISTICS

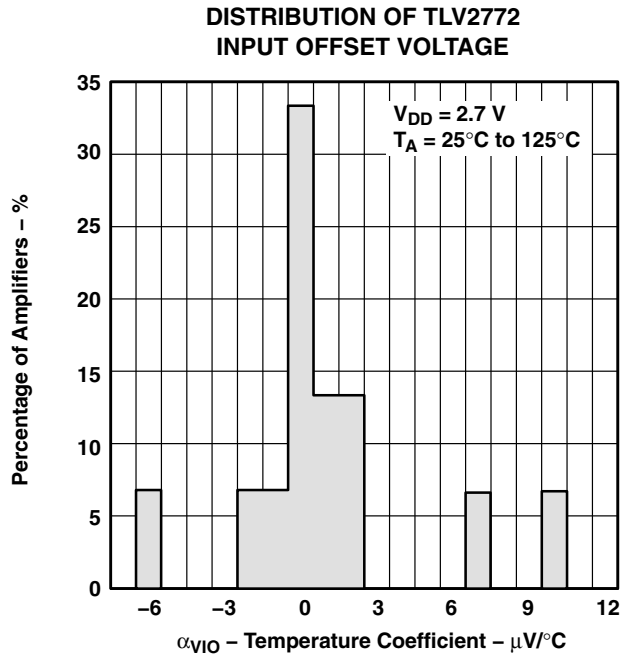

Figure 5

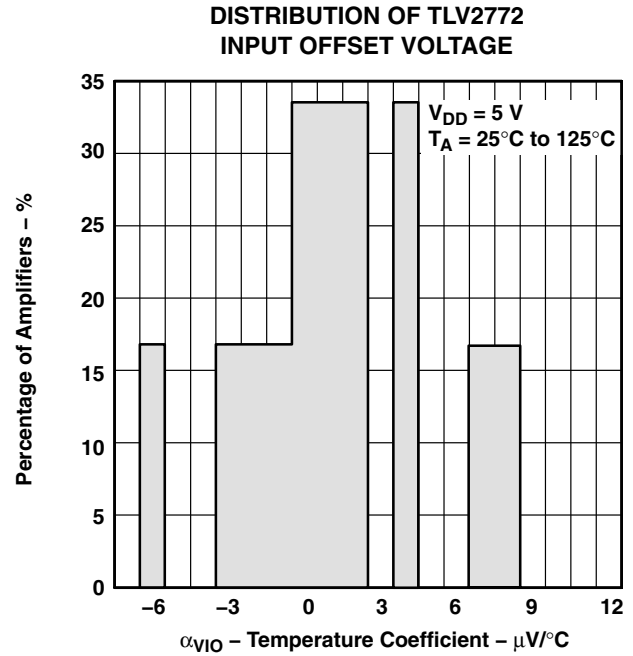

Figure 6

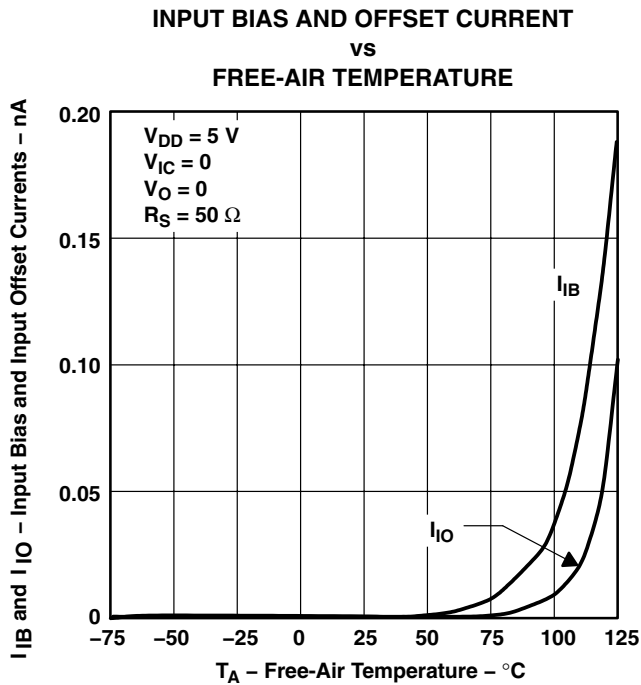

Figure 7

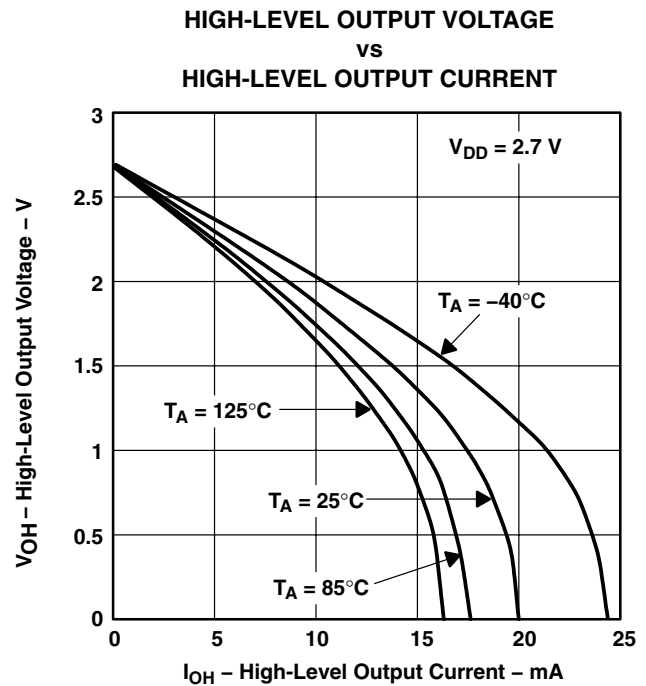

Figure 8

TLV277x-Q1, TLV277xA-Q1 FAMILY OF 2.7-V HIGH-SLEW-RATE RAIL-TO-RAIL OUTPUT OPERATIONAL AMPLIFIERS WITH SHUTDOWN

SGLS179D – SEPTEMBER 2003 – REVISED AUGUST 2008

TYPICAL CHARACTERISTICS

HIGH-LEVEL OUTPUT VOLTAGE
vs
HIGH-LEVEL OUTPUT CURRENT

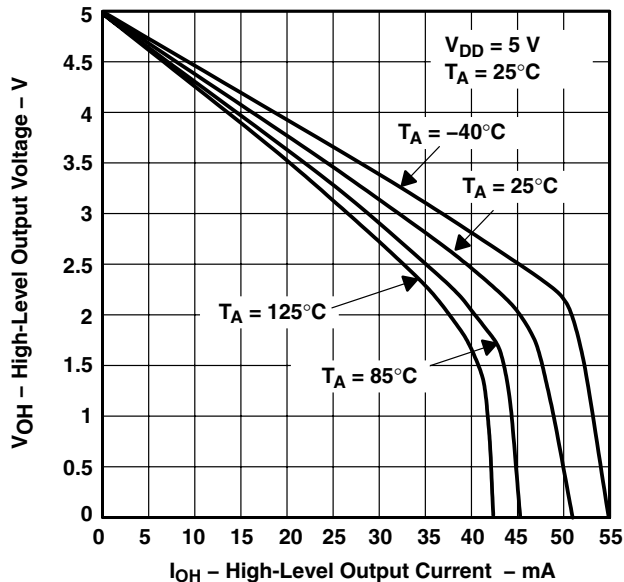

Figure 9

LOW-LEVEL OUTPUT VOLTAGE
vs
LOW-LEVEL OUTPUT CURRENT

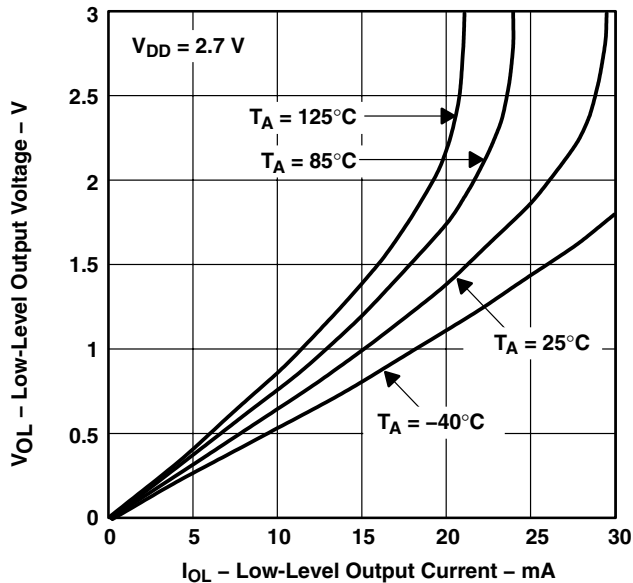

Figure 10

LOW-LEVEL OUTPUT VOLTAGE
vs
LOW-LEVEL OUTPUT CURRENT

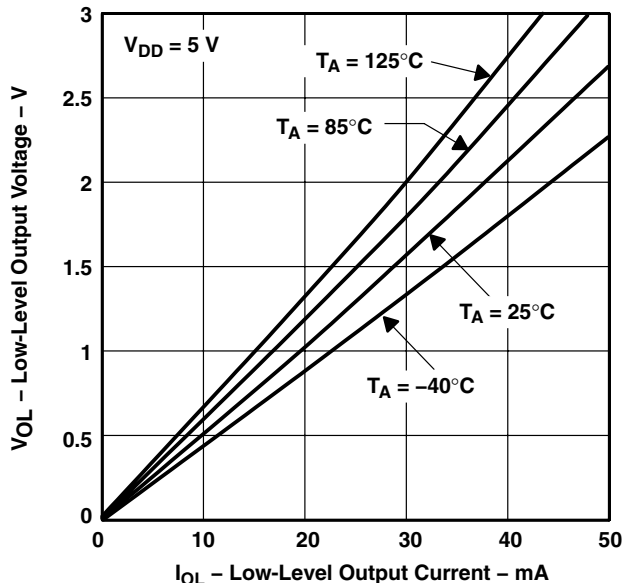

Figure 11

MAXIMUM PEAK-TO-PEAK OUTPUT VOLTAGE
vs
FREQUENCY

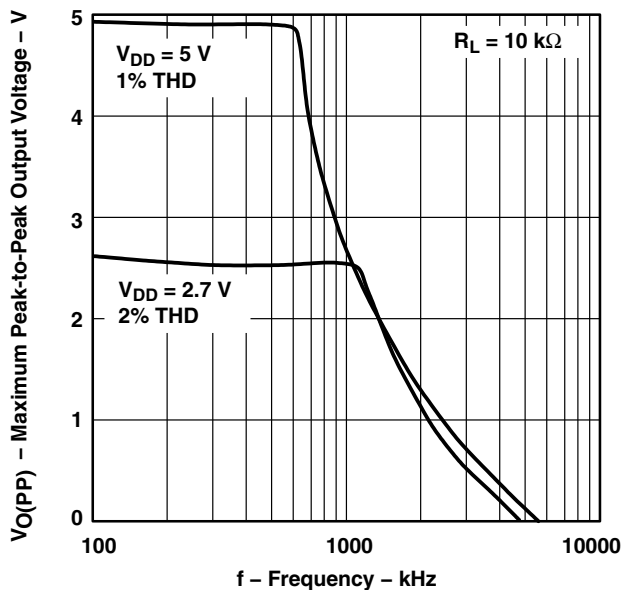
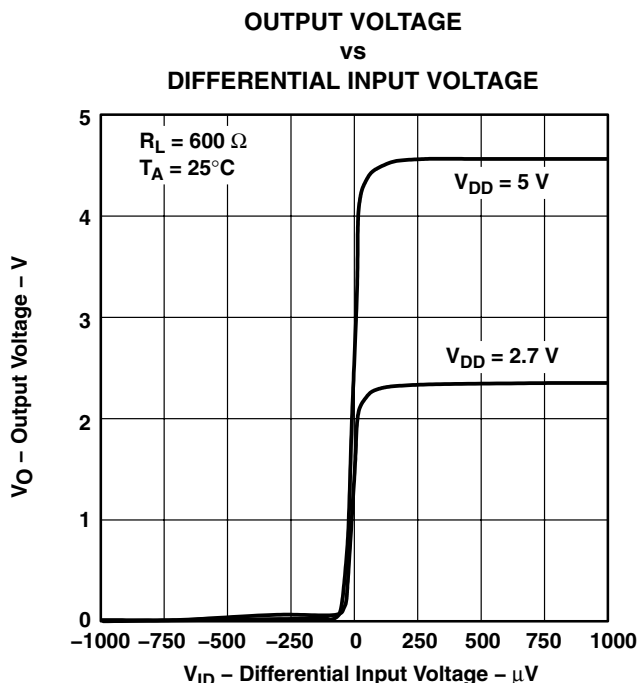
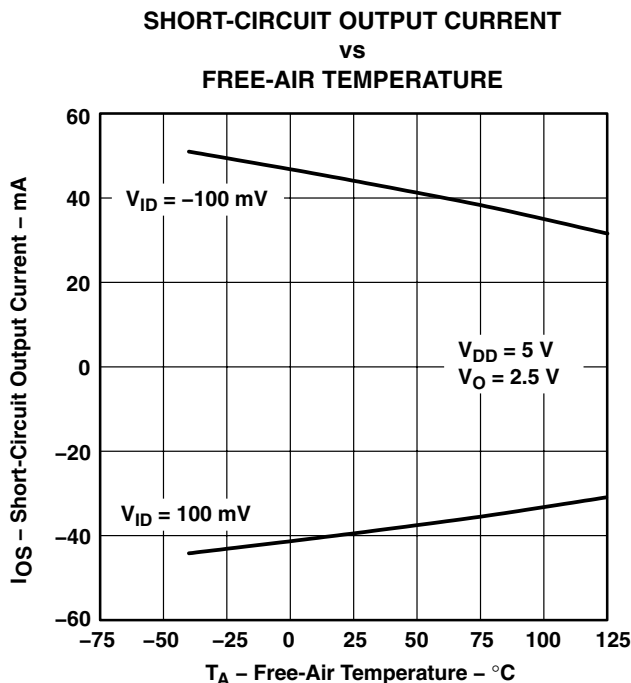
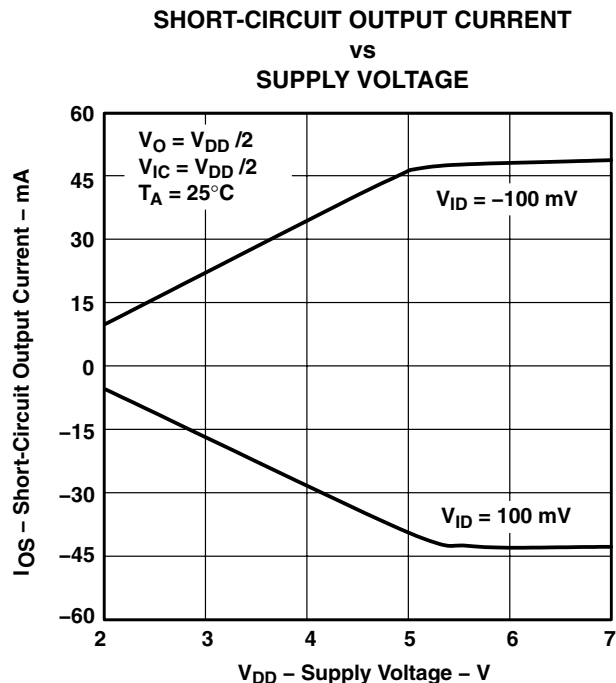
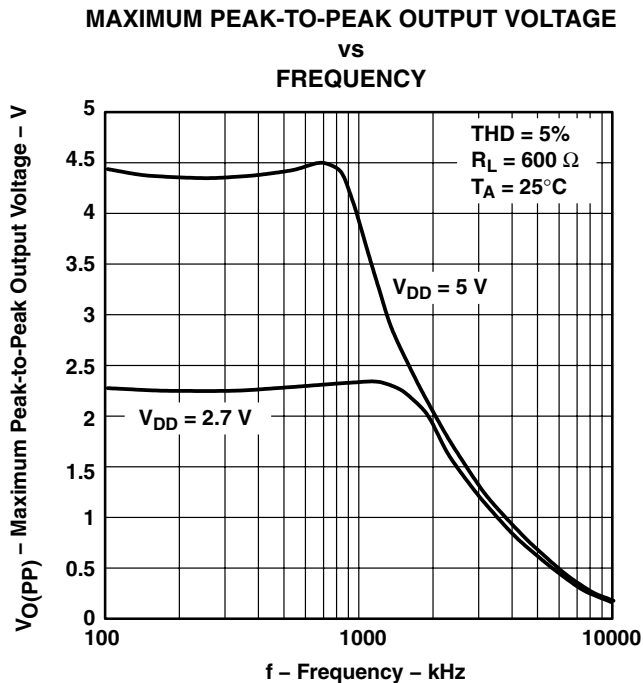

Figure 12

TLV277x-Q1, TLV277xA-Q1
FAMILY OF 2.7-V HIGH-SLEW-RATE RAIL-TO-RAIL OUTPUT
OPERATIONAL AMPLIFIERS WITH SHUTDOWN

SGLS179D – SEPTEMBER 2003 – REVISED AUGUST 2008

TYPICAL CHARACTERISTICS



TLV277x-Q1, TLV277xA-Q1
FAMILY OF 2.7-V HIGH-SLEW-RATE RAIL-TO-RAIL OUTPUT
OPERATIONAL AMPLIFIERS WITH SHUTDOWN

SGLS179D – SEPTEMBER 2003 – REVISED AUGUST 2008

TYPICAL CHARACTERISTICS

LARGE-SIGNAL DIFFERENTIAL VOLTAGE AMPLIFICATION AND PHASE MARGIN VS FREQUENCY

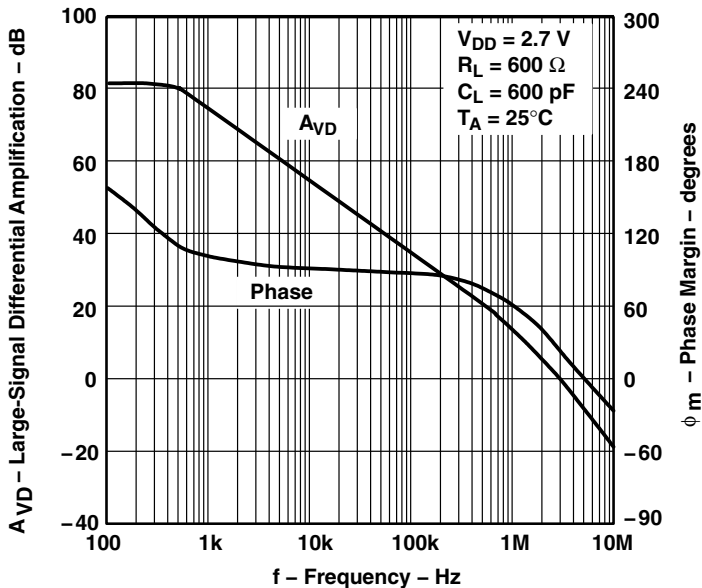

Figure 17

LARGE-SIGNAL DIFFERENTIAL VOLTAGE AMPLIFICATION AND PHASE MARGIN VS FREQUENCY

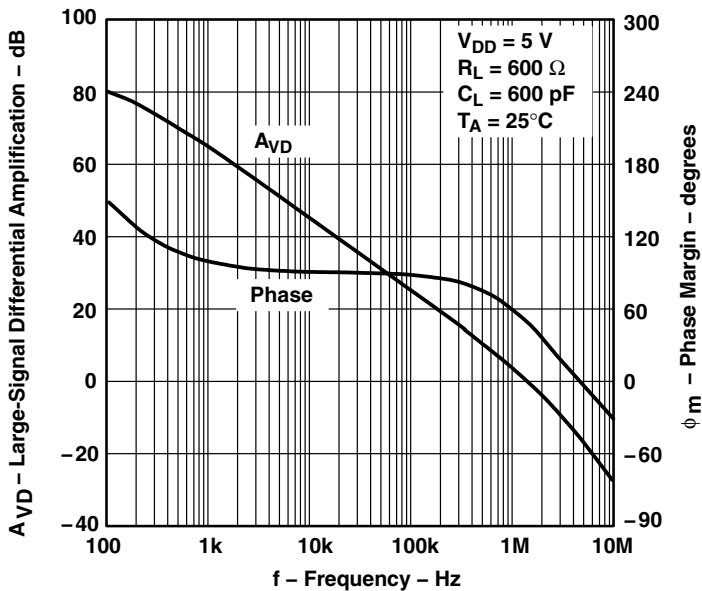

Figure 18



TLV277x-Q1, TLV277xA-Q1
FAMILY OF 2.7-V HIGH-SLEW-RATE RAIL-TO-RAIL OUTPUT
OPERATIONAL AMPLIFIERS WITH SHUTDOWN

SGLS179D – SEPTEMBER 2003 – REVISED AUGUST 2008

TYPICAL CHARACTERISTICS

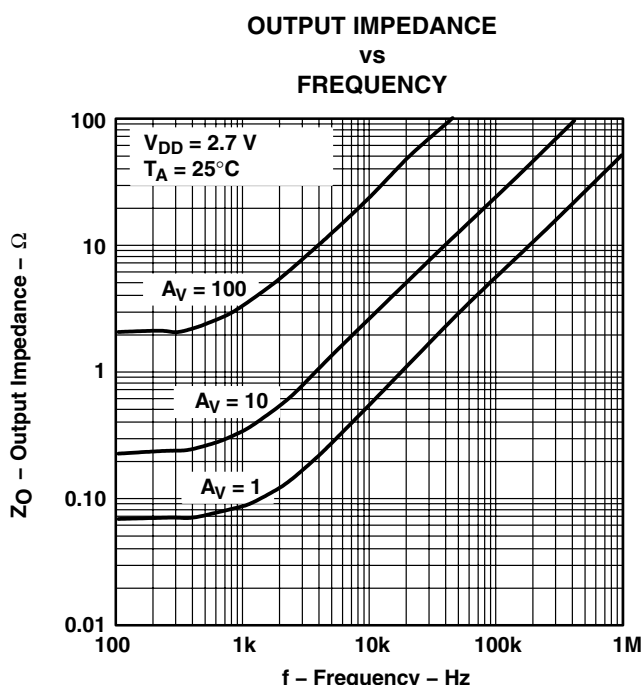
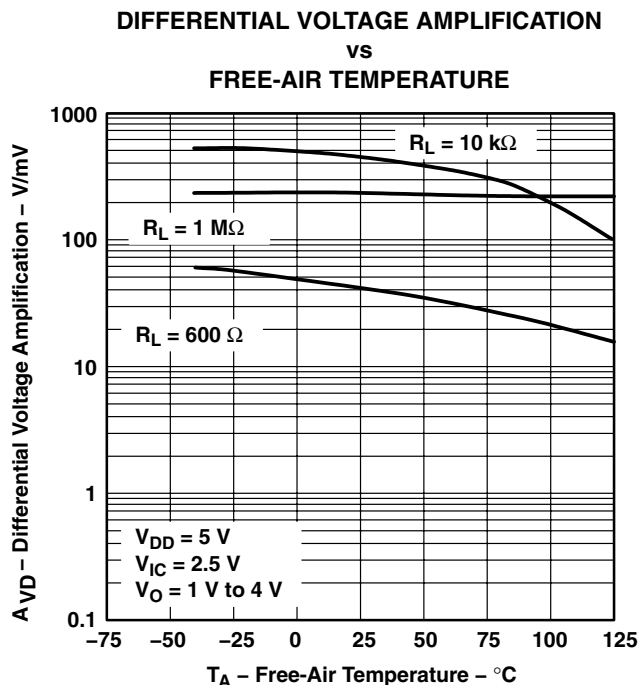
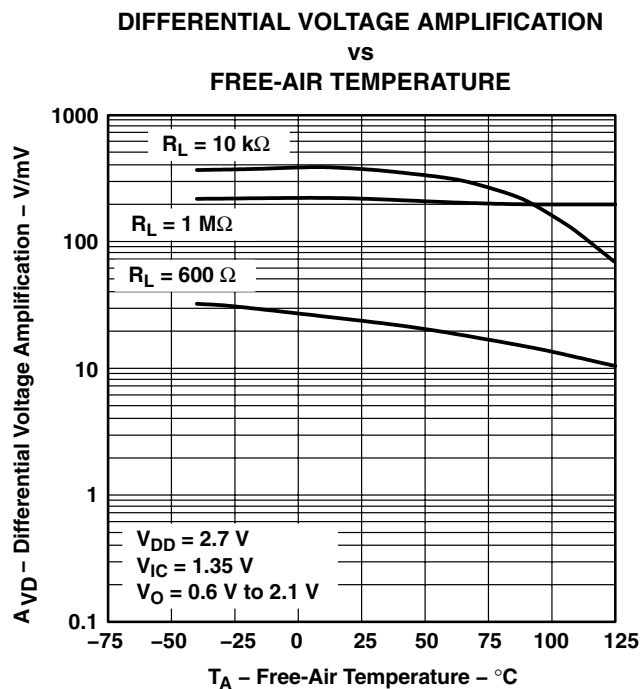
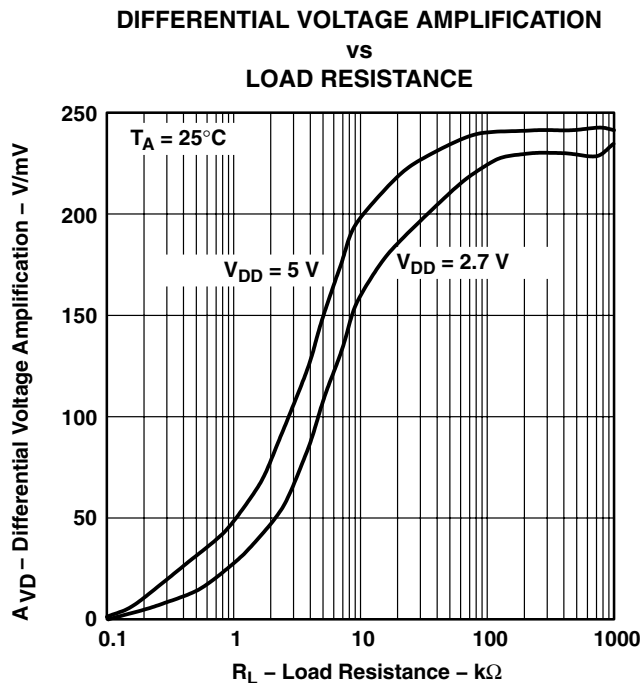

TLV277x-Q1, TLV277xA-Q1
FAMILY OF 2.7-V HIGH-SLEW-RATE RAIL-TO-RAIL OUTPUT
OPERATIONAL AMPLIFIERS WITH SHUTDOWN

SGLS179D – SEPTEMBER 2003 – REVISED AUGUST 2008

TYPICAL CHARACTERISTICS

OUTPUT IMPEDANCE
vs
FREQUENCY

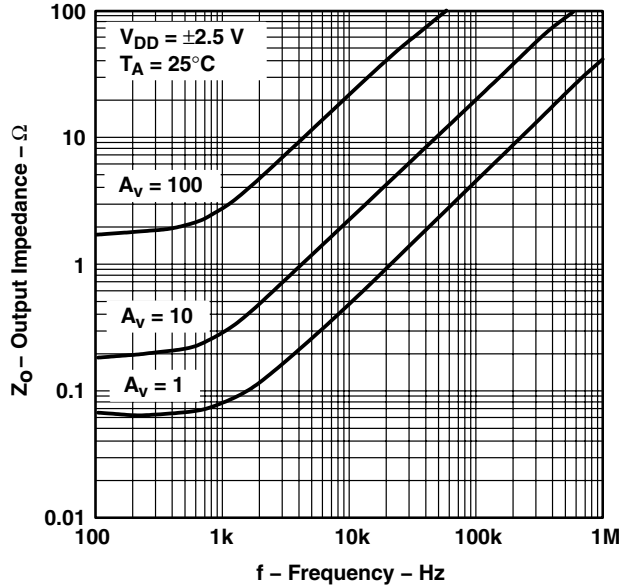

Figure 23

COMMON-MODE REJECTION RATIO
vs
FREQUENCY

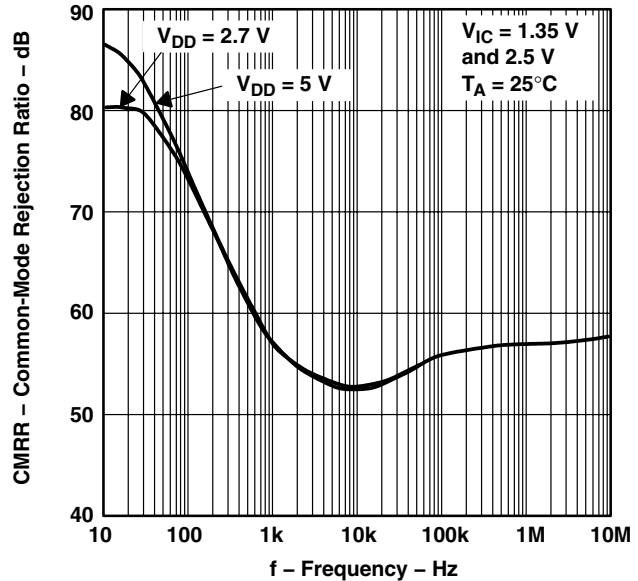

Figure 24

COMMON-MODE REJECTION RATIO
vs
FREE-AIR TEMPERATURE

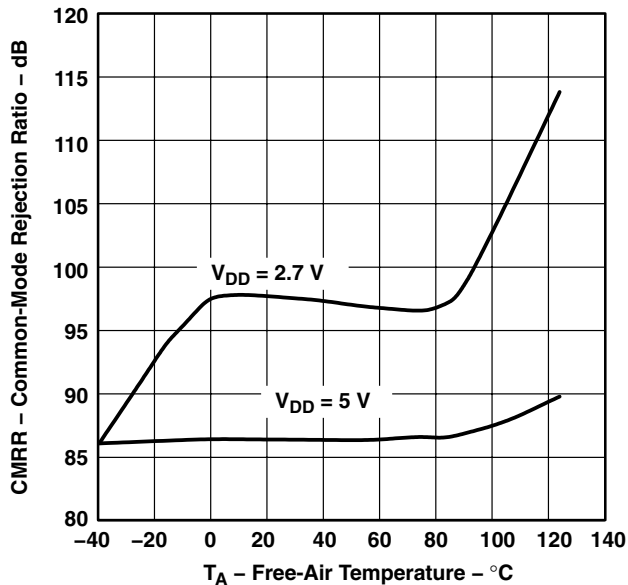

Figure 25

SUPPLY-VOLTAGE REJECTION RATIO
vs
FREQUENCY

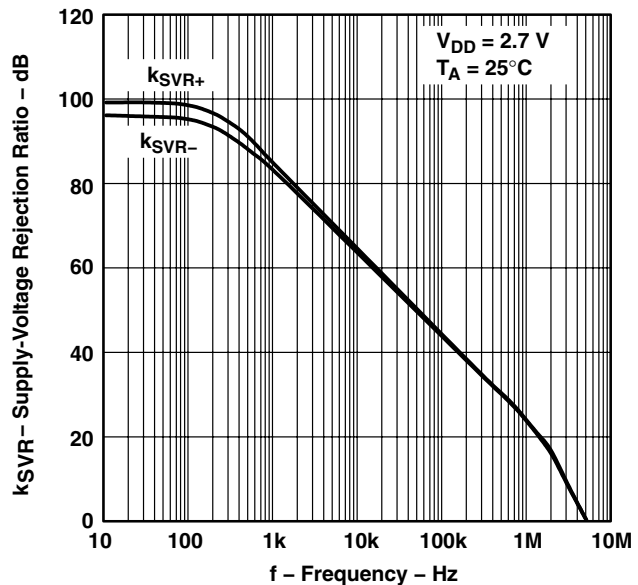

Figure 26



TLV277x-Q1, TLV277xA-Q1
FAMILY OF 2.7-V HIGH-SLEW-RATE RAIL-TO-RAIL OUTPUT
OPERATIONAL AMPLIFIERS WITH SHUTDOWN

SGLS179D – SEPTEMBER 2003 – REVISED AUGUST 2008

TYPICAL CHARACTERISTICS

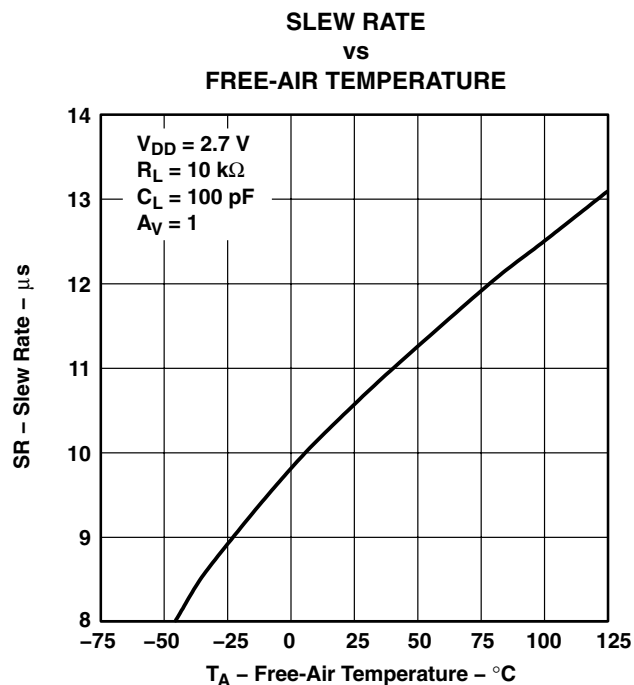
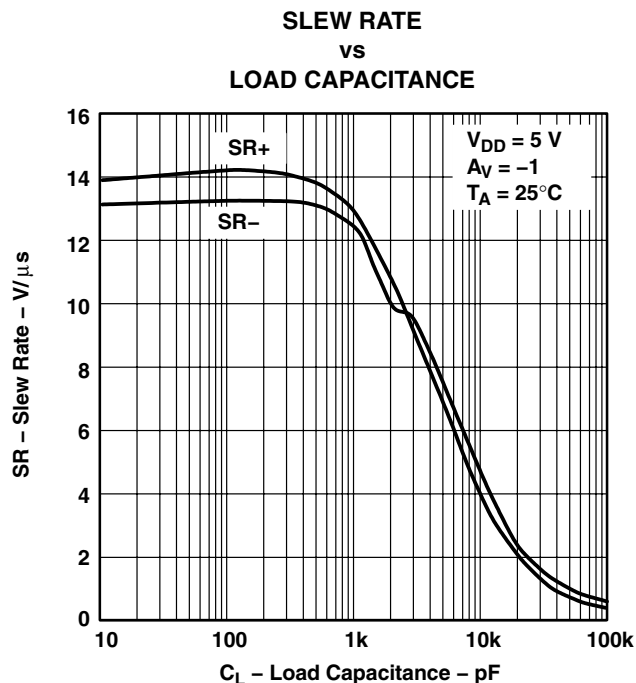
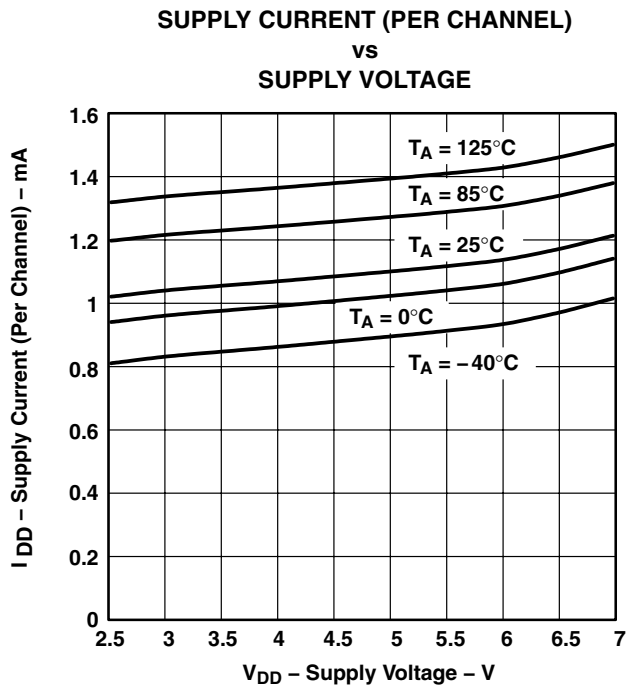
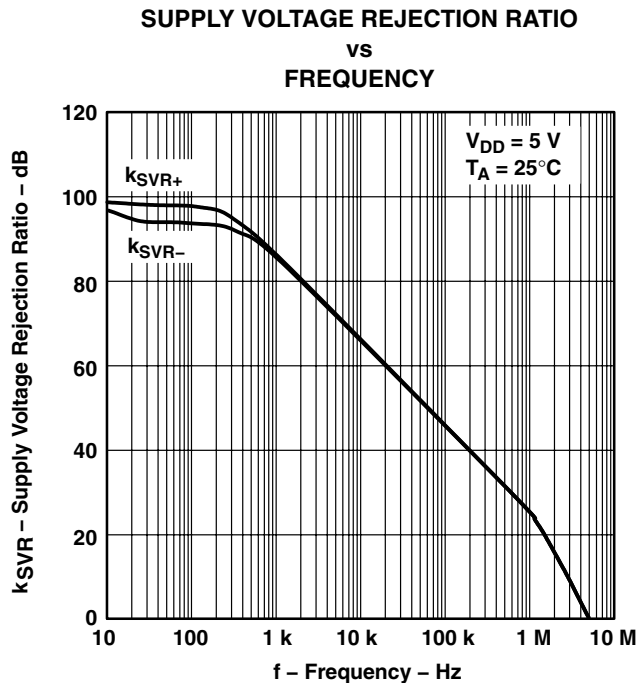

TLV277x-Q1, TLV277xA-Q1
FAMILY OF 2.7-V HIGH-SLEW-RATE RAIL-TO-RAIL OUTPUT
OPERATIONAL AMPLIFIERS WITH SHUTDOWN

SGLS179D – SEPTEMBER 2003 – REVISED AUGUST 2008

TYPICAL CHARACTERISTICS

VOLTAGE-FOLLOWER
SMALL-SIGNAL PULSE RESPONSE

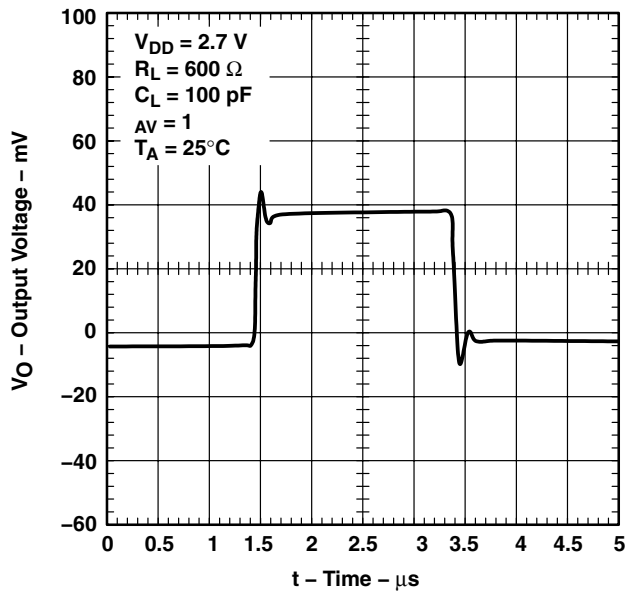

Figure 31

VOLTAGE-FOLLOWER
SMALL-SIGNAL PULSE RESPONSE

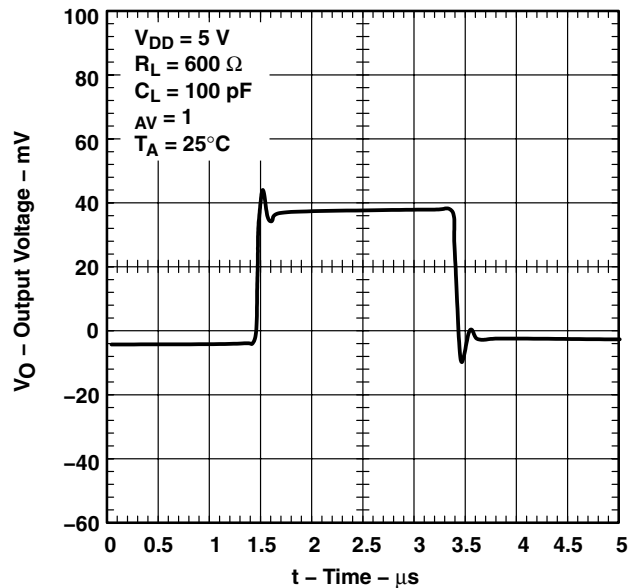

Figure 32

VOLTAGE-FOLLOWER
LARGE-SIGNAL PULSE RESPONSE

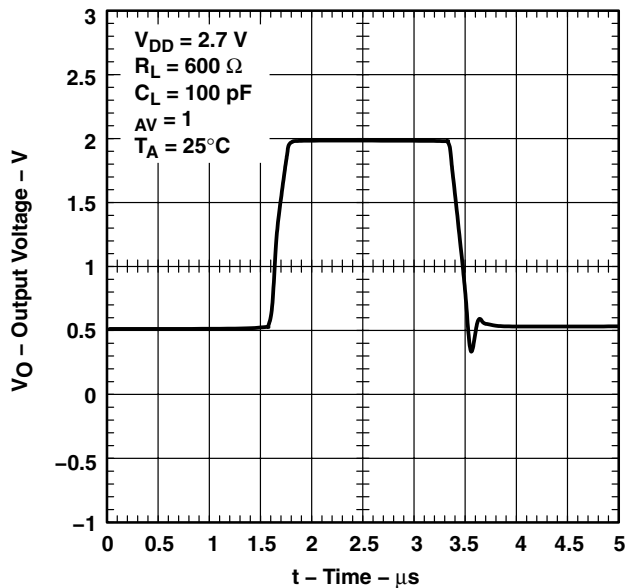

Figure 33

VOLTAGE-FOLLOWER
LARGE-SIGNAL PULSE RESPONSE

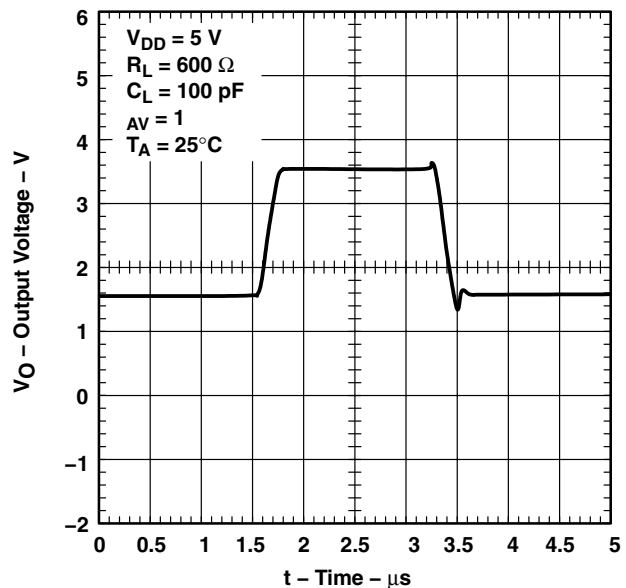

Figure 34



TLV277x-Q1, TLV277xA-Q1
FAMILY OF 2.7-V HIGH-SLEW-RATE RAIL-TO-RAIL OUTPUT
OPERATIONAL AMPLIFIERS WITH SHUTDOWN

SGLS179D – SEPTEMBER 2003 – REVISED AUGUST 2008

TYPICAL CHARACTERISTICS

**INVERTING SMALL-SIGNAL
PULSE RESPONSE**

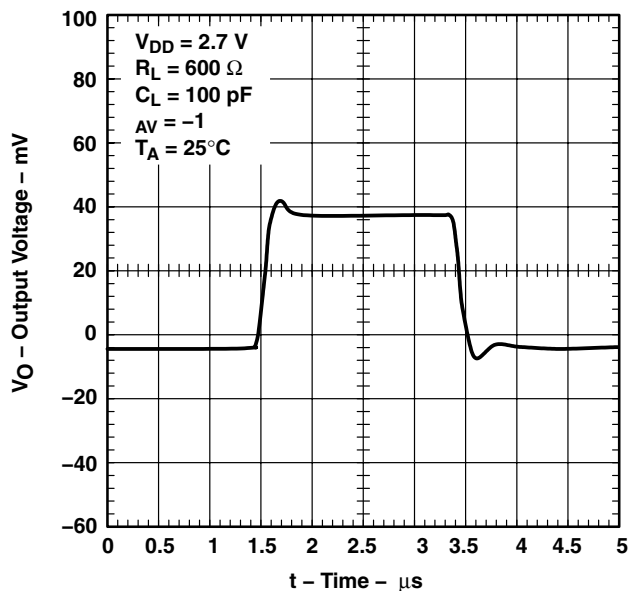

**INVERTING SMALL-SIGNAL
PULSE RESPONSE**

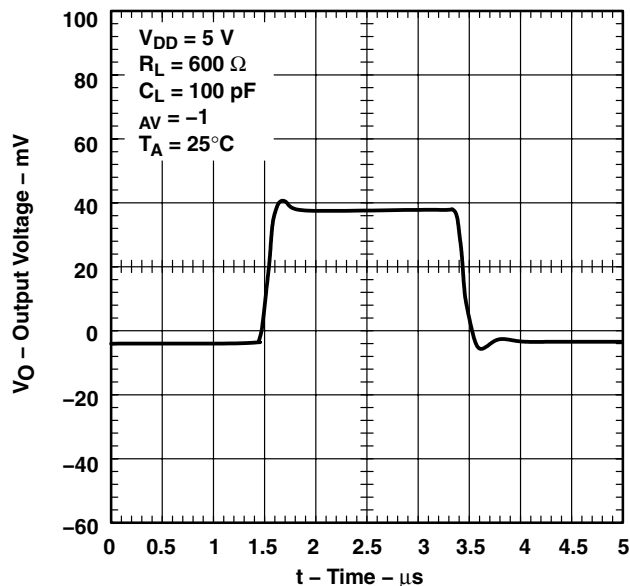

**INVERTING LARGE-SIGNAL
PULSE RESPONSE**

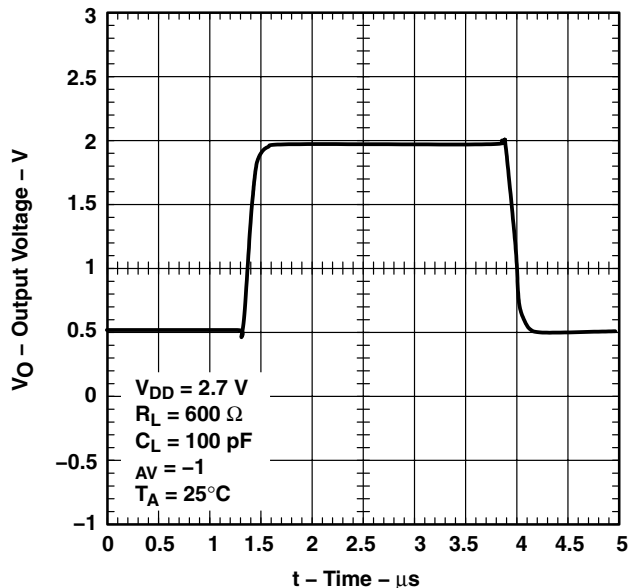

**INVERTING LARGE-SIGNAL
PULSE RESPONSE**

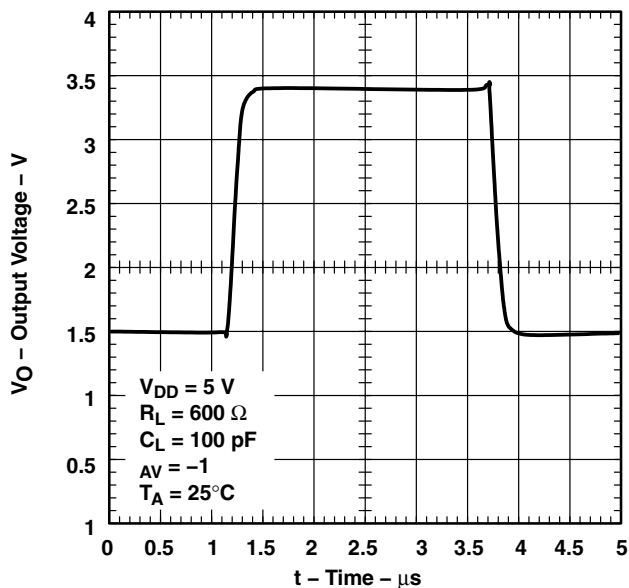

TLV277x-Q1, TLV277xA-Q1
FAMILY OF 2.7-V HIGH-SLEW-RATE RAIL-TO-RAIL OUTPUT
OPERATIONAL AMPLIFIERS WITH SHUTDOWN

SGLS179D – SEPTEMBER 2003 – REVISED AUGUST 2008

TYPICAL CHARACTERISTICS

**EQUIVALENT INPUT NOISE VOLTAGE
vs
FREQUENCY**

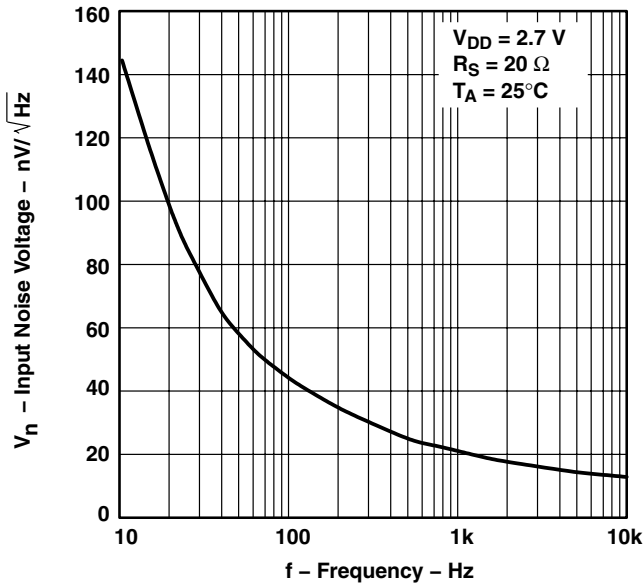

Figure 39

**EQUIVALENT INPUT NOISE VOLTAGE
vs
FREQUENCY**

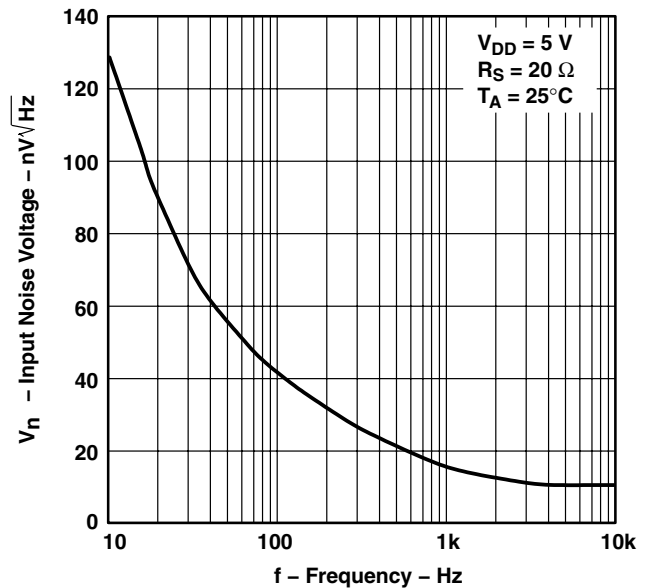

Figure 40

**NOISE VOLTAGE
OVER A 10 SECOND PERIOD**

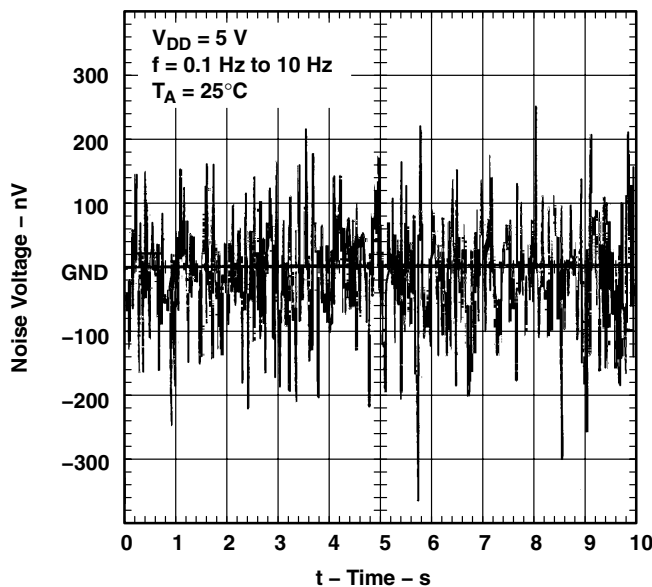

Figure 41

TLV277x-Q1, TLV277xA-Q1
FAMILY OF 2.7-V HIGH-SLEW-RATE RAIL-TO-RAIL OUTPUT
OPERATIONAL AMPLIFIERS WITH SHUTDOWN

SGLS179D – SEPTEMBER 2003 – REVISED AUGUST 2008

TYPICAL CHARACTERISTICS

TOTAL HARMONIC DISTORTION PLUS NOISE
vs
FREQUENCY

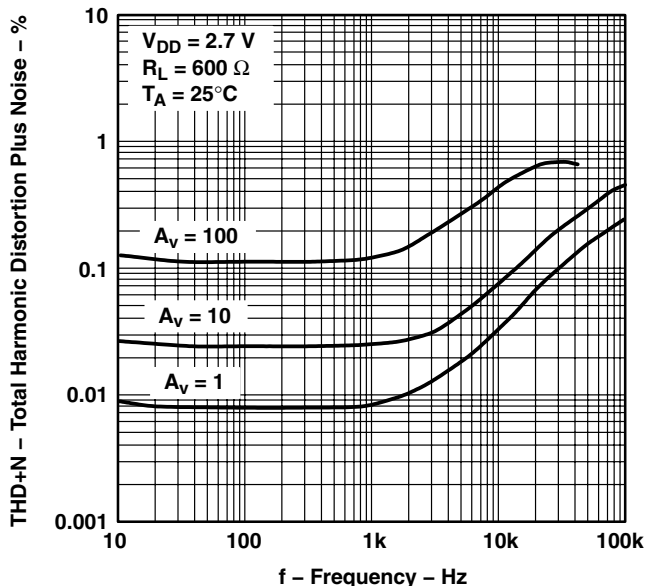

Figure 42

TOTAL HARMONIC DISTORTION PLUS NOISE
vs
FREQUENCY

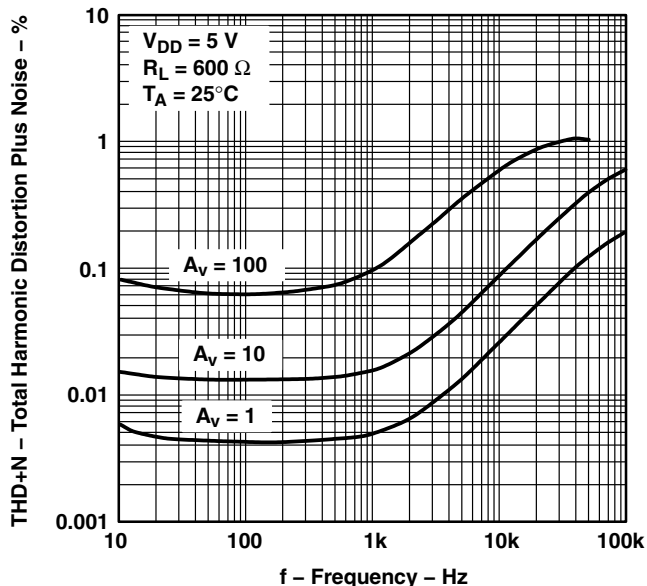

Figure 43

GAIN-BANDWIDTH PRODUCT
vs
SUPPLY VOLTAGE

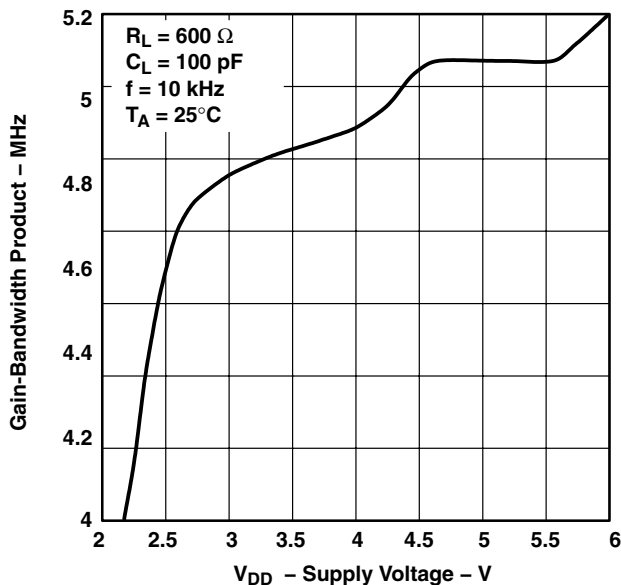

Figure 44

UNITY-GAIN BANDWIDTH
vs
LOAD CAPACITANCE

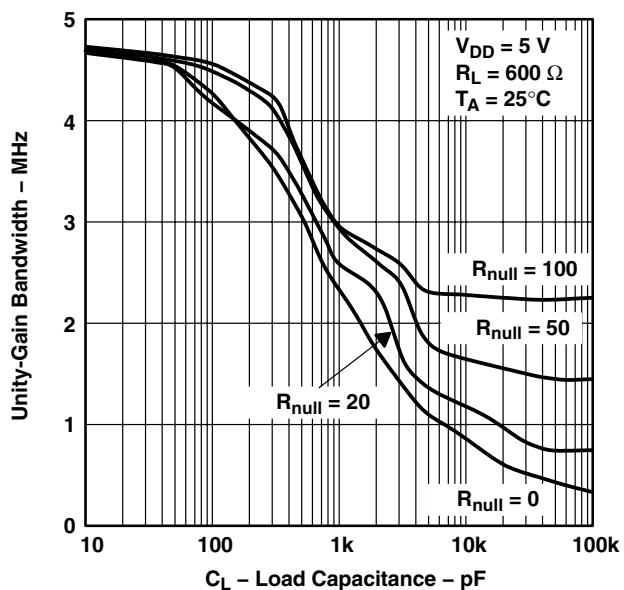

Figure 45

TLV277x-Q1, TLV277xA-Q1
FAMILY OF 2.7-V HIGH-SLEW-RATE RAIL-TO-RAIL OUTPUT
OPERATIONAL AMPLIFIERS WITH SHUTDOWN

SGLS179D – SEPTEMBER 2003 – REVISED AUGUST 2008

TYPICAL CHARACTERISTICS

PHASE MARGIN
vs
LOAD CAPACITANCE

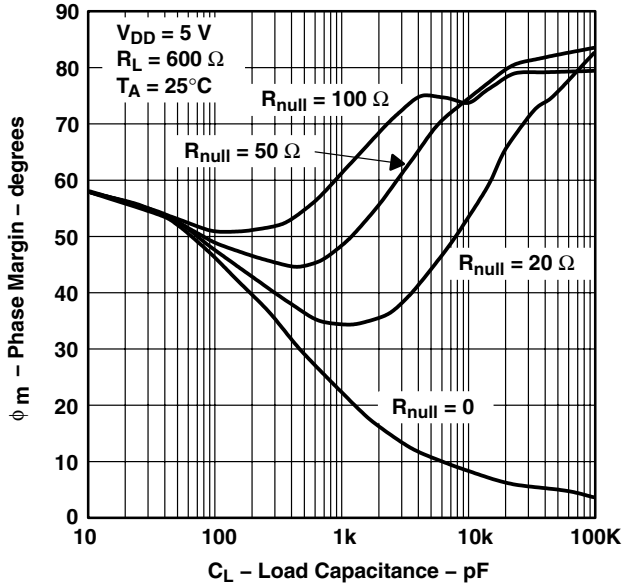

Figure 46

GAIN MARGIN
vs
LOAD CAPACITANCE

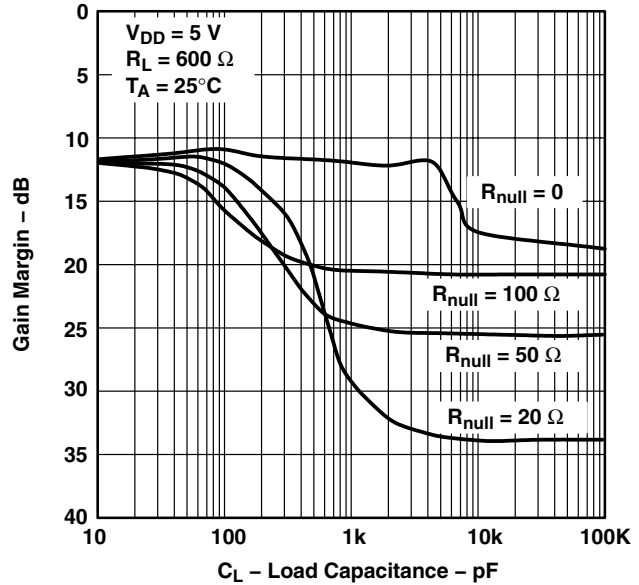

Figure 47

TLV2770
AMPLIFIER WITH SHUTDOWN PULSE
TURNON/OFF CHARACTERISTICS

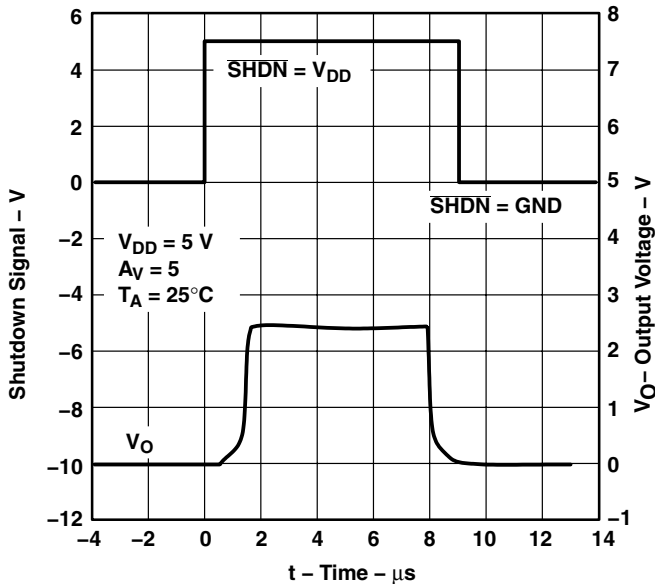

Figure 48

TLV2773
AMPLIFIER WITH SHUTDOWN PULSE
TURNON/OFF CHARACTERISTICS

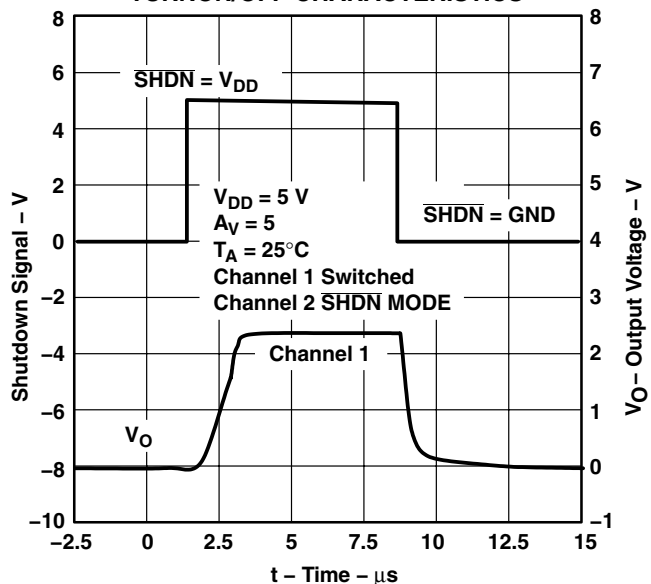

Figure 49



TLV277x-Q1, TLV277xA-Q1 FAMILY OF 2.7-V HIGH-SLEW-RATE RAIL-TO-RAIL OUTPUT OPERATIONAL AMPLIFIERS WITH SHUTDOWN

SGLS179D – SEPTEMBER 2003 – REVISED AUGUST 2008

TYPICAL CHARACTERISTICS

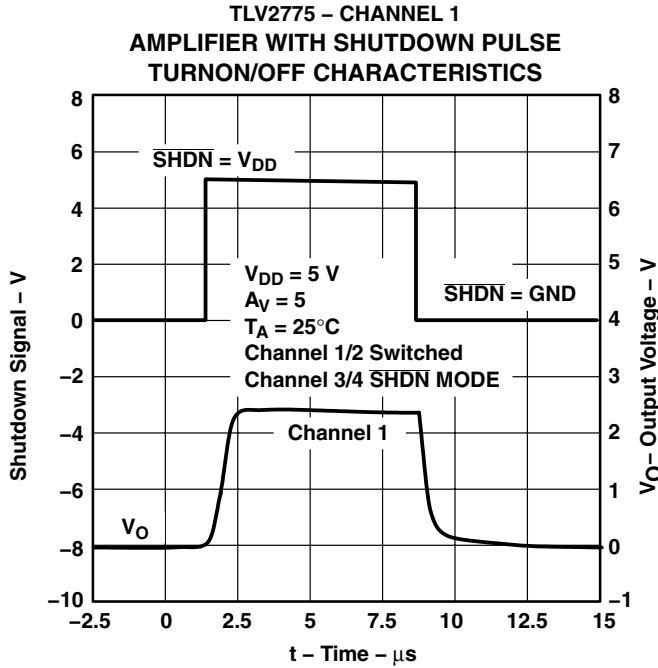

Figure 50

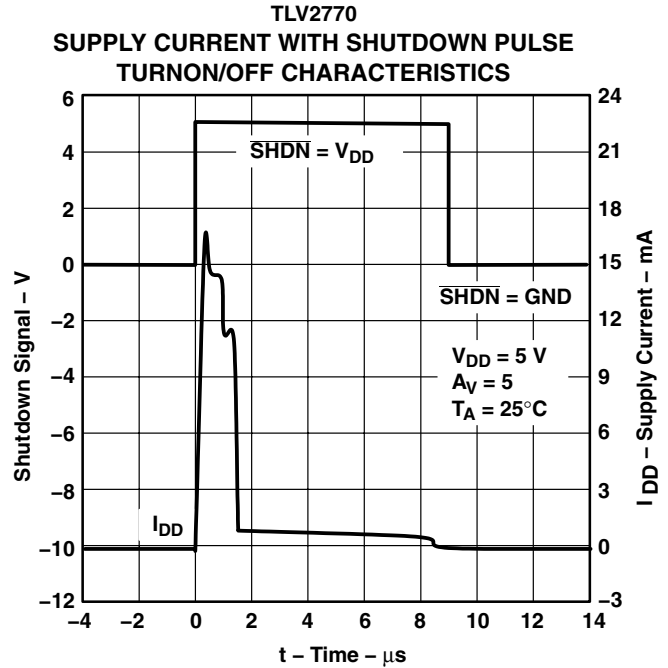

Figure 51

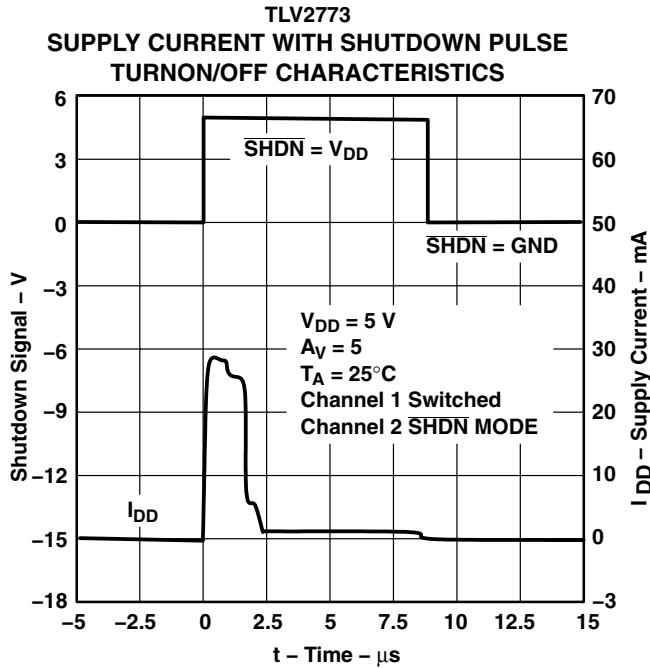

Figure 52

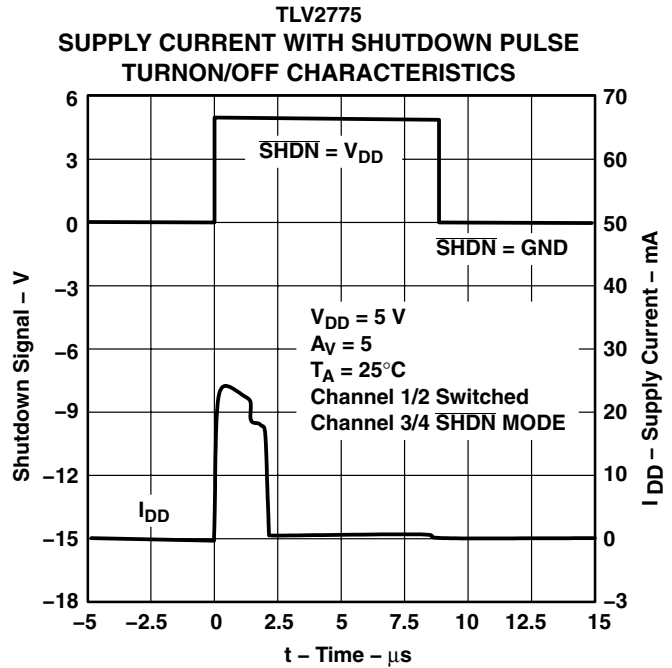
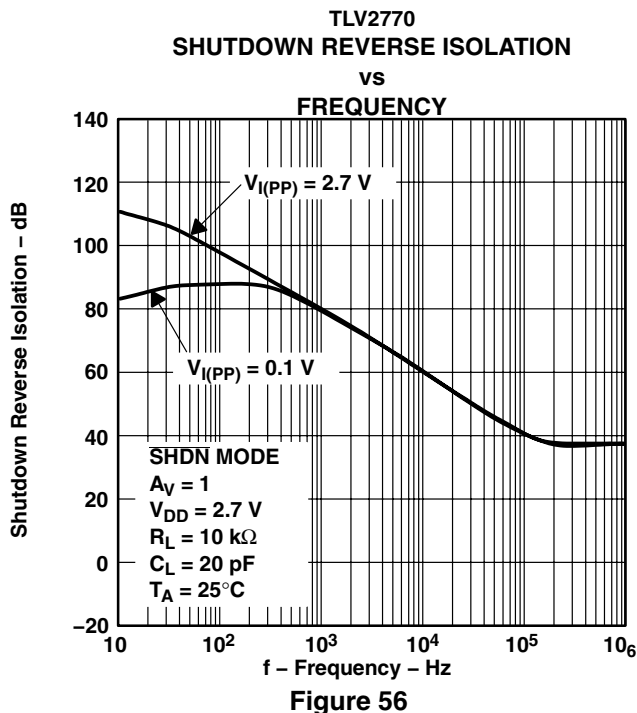
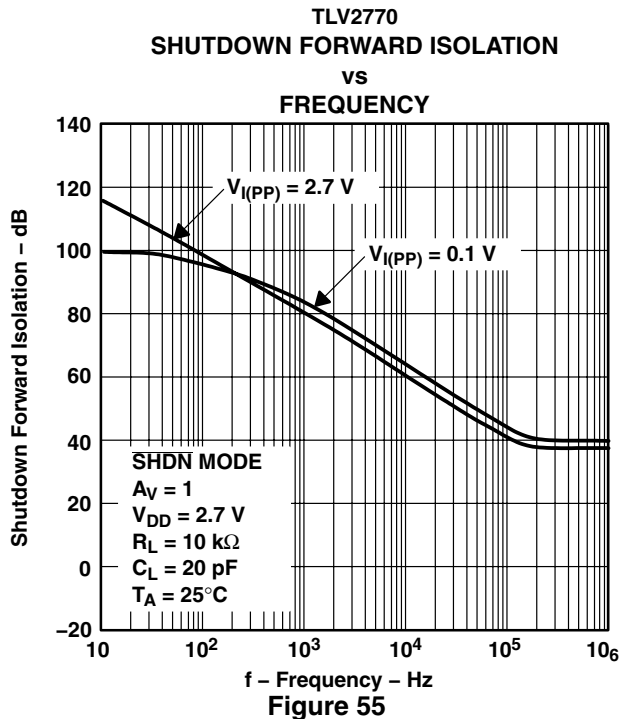
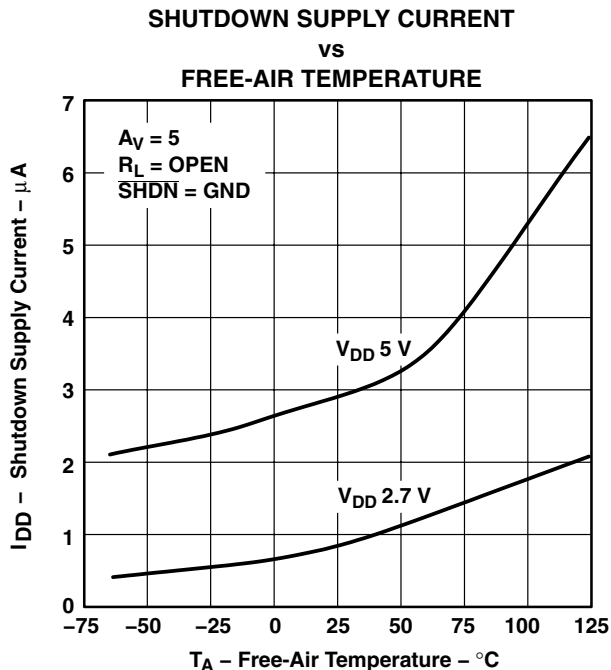

Figure 53

TLV277x-Q1, TLV277xA-Q1 FAMILY OF 2.7-V HIGH-SLEW-RATE RAIL-TO-RAIL OUTPUT OPERATIONAL AMPLIFIERS WITH SHUTDOWN

SGLS179D – SEPTEMBER 2003 – REVISED AUGUST 2008

TYPICAL CHARACTERISTICS



PARAMETER MEASUREMENT INFORMATION

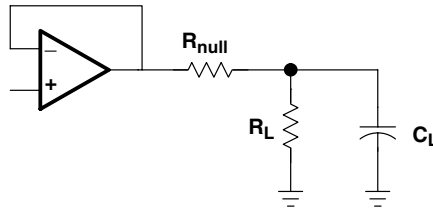

Figure 57

driving a capacitive load

When the amplifier is configured in this manner, capacitive loading directly on the output decreases the device's phase margin leading to high frequency ringing or oscillations. Therefore, for capacitive loads of greater than 10 pF, it is recommended that a resistor be placed in series (R_{NULL}) with the output of the amplifier, as shown in Figure 58. A minimum value of 20 Ω should work well for most applications.

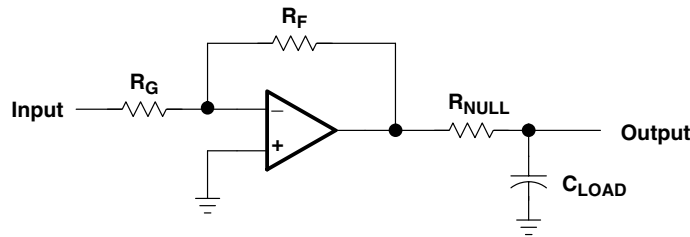

Figure 58. Driving a Capacitive Load

TLV277x-Q1, TLV277xA-Q1 FAMILY OF 2.7-V HIGH-SLEW-RATE RAIL-TO-RAIL OUTPUT OPERATIONAL AMPLIFIERS WITH SHUTDOWN

SGLS179D – SEPTEMBER 2003 – REVISED AUGUST 2008

APPLICATION INFORMATION

offset voltage

The output offset voltage, (V_{OO}) is the sum of the input offset voltage (V_{IO}) and both input bias currents (I_{IB}) times the corresponding gains. The following schematic and formula can be used to calculate the output offset voltage:

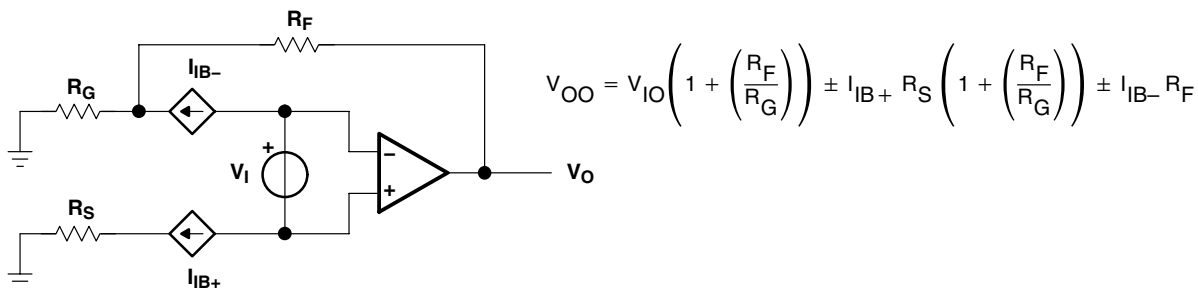

Figure 59. Output Offset Voltage Model

general configurations

When receiving low-level signals, limiting the bandwidth of the incoming signals into the system is often required. The simplest way to accomplish this is to place an RC filter at the noninverting terminal of the amplifier (see Figure 60).

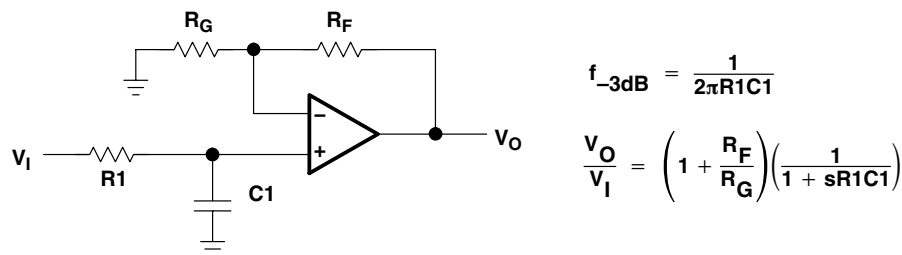

Figure 60. Single-Pole Low-Pass Filter

If even more attenuation is needed, a multiple pole filter is required. The Sallen-Key filter can be used for this task. For best results, the amplifier should have a bandwidth that is 8 to 10 times the filter frequency bandwidth. Failure to do this can result in phase shift of the amplifier.

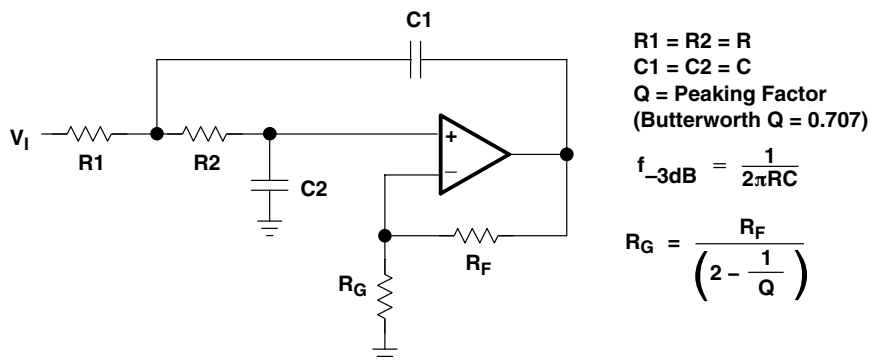

Figure 61. 2-Pole Low-Pass Sallen-Key Filter

APPLICATION INFORMATION

using the TLV2772 as an accelerometer interface

The schematic, shown in Figure 62, shows the ACH04-08-05 interfaced to the TLV1544 10-bit analog-to-digital converter (ADC).

The ACH04-08-05 is a shock sensor designed to convert mechanical acceleration into electrical signals. The sensor contains three piezoelectric sensing elements oriented to simultaneously measure acceleration in three orthogonal, linear axes (x, y, z). The operating frequency is 0.5 Hz to 5 kHz. The output is buffered with an internal JFET and has a typical output voltage of 1.80 mV/g for the x and y axis and 1.35 mV/g for the z axis.

Amplification and frequency shaping of the shock sensor output is done by the TLV2772 rail-to-rail operational amplifier. The TLV2772 is ideal for this application as it offers high input impedance, good slew rate, and excellent dc precision. The rail-to-rail output swing and high output drive are perfect for driving the analog input of the TLV1544 ADC.

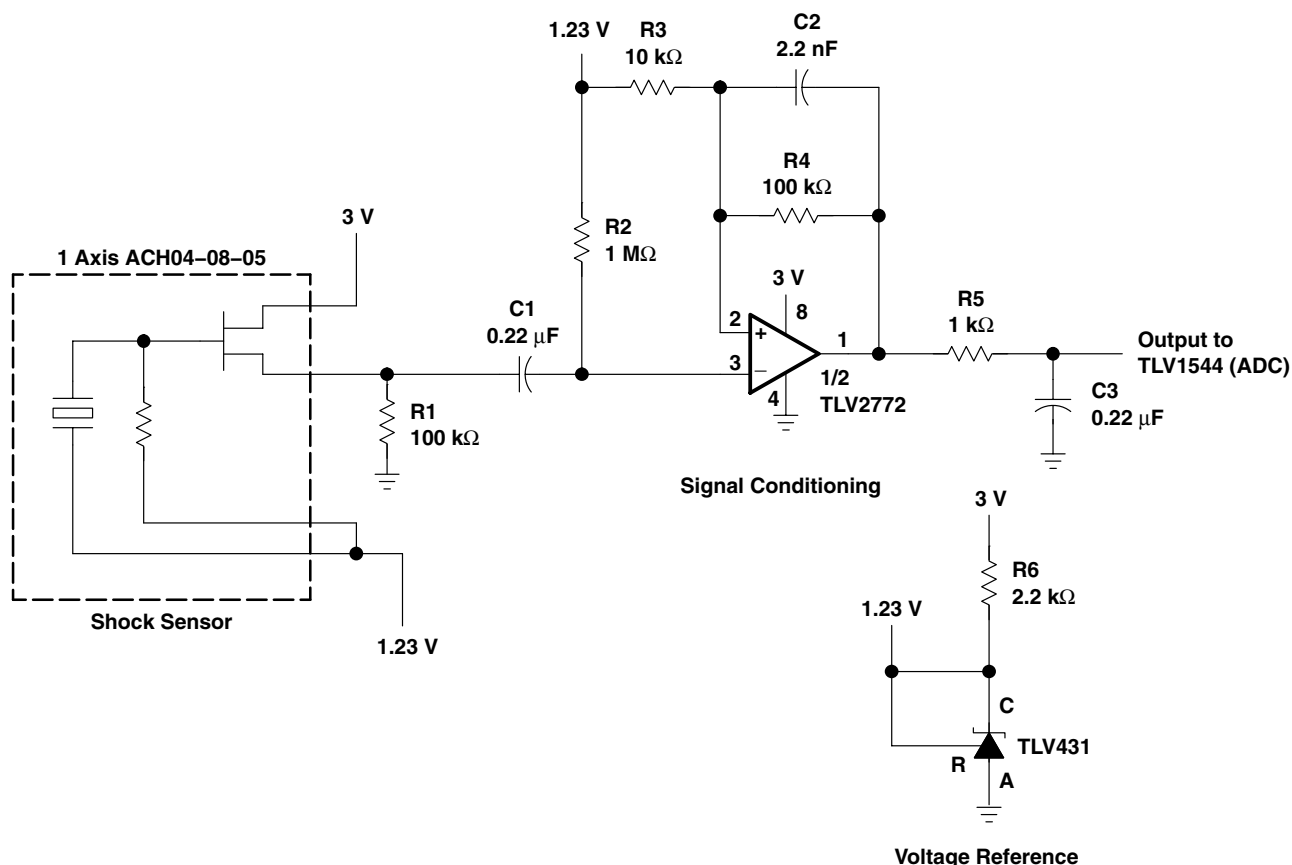

Figure 62. Accelerometer Interface Schematic

The sensor signal must be amplified and frequency-shaped to provide a signal the ADC can properly convert into the digital domain. Figure 62 shows the topology used in this application for one axis of the sensor. This system is powered from a single 3-V supply. Configuring the TLV431 with a 2.2-kΩ resistor produces a reference voltage of 1.23 V. This voltage is used to bias the operational amplifier and the internal JFETs in the shock sensor.

TLV277x-Q1, TLV277xA-Q1 FAMILY OF 2.7-V HIGH-SLEW-RATE RAIL-TO-RAIL OUTPUT OPERATIONAL AMPLIFIERS WITH SHUTDOWN

SGLS179D – SEPTEMBER 2003 – REVISED AUGUST 2008

APPLICATION INFORMATION

gain calculation

Since the TLV2772 is capable of rail-to-rail output using a 3-V supply, $V_O = 0$ (min) to 3 V (max). With no signal from the sensor, nominal $V_O =$ reference voltage = 1.23 V. Therefore, the maximum negative swing from nominal is $0\text{ V} - 1.23\text{ V} = -1.23\text{ V}$ and the maximum positive swing is $3\text{ V} - 1.23\text{ V} = 1.77\text{ V}$. By modeling the shock sensor as a low impedance voltage source with output of 2.25 mV/g (max) in the x and y axis and 1.7 mV/g (max) in the z axis, the gain of the circuit is calculated by equation 1.

$$\text{Gain} = \frac{\text{Output Swing}}{\text{Sensor Signal} \times \text{Acceleration}} \quad (1)$$

To avoid saturation of the operational amplifier, the gain calculations are based on the maximum negative swing of -1.23 V and the maximum sensor output of 2.25 mV/g (x and y axis) and 1.70 mV/g (z axis).

$$\text{Gain (x, y)} = \frac{-1.23\text{ V}}{2.25\text{ mV/g} \times -50\text{ g}} = 10.9 \quad (2)$$

and

$$\text{Gain (z)} = \frac{-1.23\text{ V}}{1.70\text{ mV/g} \times -50\text{ g}} = 14.5 \quad (3)$$

By selecting $R_3 = 10\text{ k}\Omega$ and $R_4 = 100\text{ k}\Omega$, in the x and y channels, a gain of 11 is realized. By selecting $R_3 = 7.5\text{ k}\Omega$ and $R_4 = 100\text{ k}\Omega$, in the z channel, a gain of 14.3 is realized. The schematic shows the configuration for either the x- or y-axis.

bandwidth calculation

To calculate the component values for the frequency shaping characteristics of the signal conditioning circuit, 1 Hz and 500 Hz are selected as the minimum required 3-dB bandwidth.

To minimize the value of the input capacitor (C1) required to set the lower cutoff frequency requires a large value resistor for R2 is required. A 1-M Ω resistor is used in this example. To set the lower cutoff frequency, the required capacitor value for C1 is:

$$C1 = \frac{1}{2\pi f_{\text{LOW}} R_2} = 0.159\text{ }\mu\text{F} \quad (4)$$

Using a value of 0.22 μF , a more common value of capacitor, the lower cutoff frequency is 0.724 Hz.

To minimize the phase shift in the feedback loop caused by the input capacitance of the TLV2772, it is best to minimize the value of the feedback resistor R4. However, to reduce the required capacitance in the feedback loop a large value for R4 is required. Therefore, a compromise for the value of R4 must be made. In this circuit, a value of 100 k Ω has been selected. To set the upper cutoff frequency, the required capacitor value for C2 is:

$$C2 = \frac{1}{2\pi f_{\text{HIGH}} R_4} = 3.18\text{ }\mu\text{F} \quad (5)$$

Using a 2.2-nF capacitor, the upper cutoff frequency is 724 Hz.

R5 and C3 also cause the signal response to roll off. Therefore, it is beneficial to design this roll-off point to begin at the upper cutoff frequency. Assuming a value of 1 k Ω for R5, the value for C3 is calculated to be 0.22 μF .

APPLICATION INFORMATION

circuit layout considerations

To achieve the levels of high performance of the TLV277x, follow proper printed-circuit board design techniques. A general set of guidelines is given in the following.

- Ground planes—It is highly recommended that a ground plane be used on the board to provide all components with a low inductive ground connection. However, in the areas of the amplifier inputs and output, the ground plane can be removed to minimize the stray capacitance.
- Proper power supply decoupling—Use a 6.8- μ F tantalum capacitor in parallel with a 0.1- μ F ceramic capacitor on each supply terminal. It may be possible to share the tantalum among several amplifiers depending on the application, but a 0.1- μ F ceramic capacitor should always be used on the supply terminal of every amplifier. In addition, the 0.1- μ F capacitor should be placed as close as possible to the supply terminal. As this distance increases, the inductance in the connecting trace makes the capacitor less effective. The designer should strive for distances of less than 0.1 inches between the device power terminals and the ceramic capacitors.
- Sockets—Sockets can be used but are not recommended. The additional lead inductance in the socket pins will often lead to stability problems. Surface-mount packages soldered directly to the printed-circuit board is the best implementation.
- Short trace runs/compact part placements—Optimum high performance is achieved when stray series inductance has been minimized. To realize this, the circuit layout should be made as compact as possible, thereby minimizing the length of all trace runs. Particular attention should be paid to the inverting input of the amplifier. Its length should be kept as short as possible. This helps to minimize stray capacitance at the input of the amplifier.
- Surface-mount passive components—Using surface-mount passive components is recommended for high performance amplifier circuits for several reasons. First, because of the extremely low lead inductance of surface-mount components, the problem with stray series inductance is greatly reduced. Second, the small size of surface-mount components naturally leads to a more compact layout thereby minimizing both stray inductance and capacitance. If leaded components are used, it is recommended that the lead lengths be kept as short as possible.

TLV277x-Q1, TLV277xA-Q1
FAMILY OF 2.7-V HIGH-SLEW-RATE RAIL-TO-RAIL OUTPUT
OPERATIONAL AMPLIFIERS WITH SHUTDOWN

SGLS179D- SEPTEMBER 2003 - REVISED AUGUST 2008

APPLICATION INFORMATION

general power dissipation considerations

For a given θ_{JA} , the maximum power dissipation is shown in Figure 63 and is calculated by the following formula:

$$P_D = \left(\frac{T_{MAX} - T_A}{\theta_{JA}} \right)$$

Where:

- P_D = Maximum power dissipation of TLV277x IC (watts)
- T_{MAX} = Absolute maximum junction temperature (150°C)
- T_A = Free-ambient air temperature (°C)
- θ_{JA} = $\theta_{JC} + \theta_{CA}$
- θ_{JC} = Thermal coefficient from junction-to-case
- θ_{CA} = Thermal coefficient from case to ambient air (°C/W)

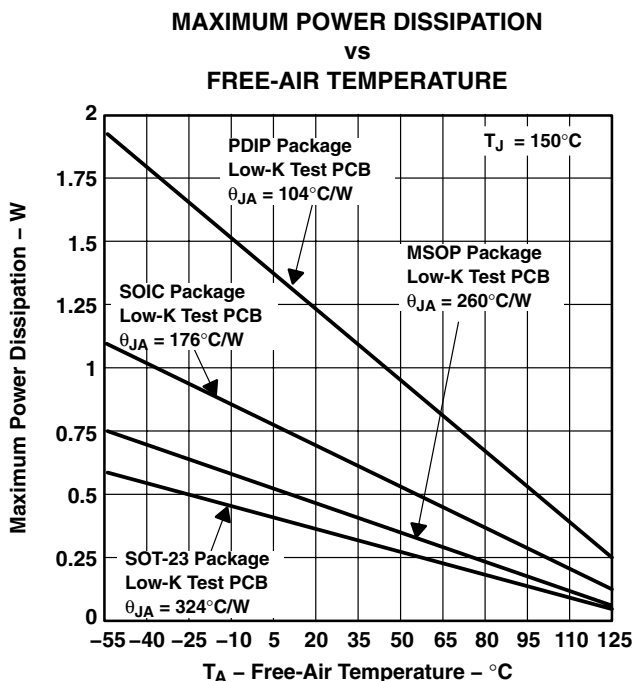

NOTE A: Results are with no air flow and using JEDEC Standard Low-K test PCB.

Figure 63.



APPLICATION INFORMATION

shutdown function

Three members of the TLV277x family (TLV2770/3/5) have a shutdown terminal for conserving battery life in portable applications. When the shutdown terminal is tied low, the supply current is reduced to 0.8 $\mu\text{A}/\text{channel}$, the amplifier is disabled, and the outputs are placed in a high impedance mode. To enable the amplifier, the shutdown terminal can either be left floating or pulled high. When the shutdown terminal is left floating, care needs to be taken to ensure that parasitic leakage current at the shutdown terminal does not inadvertently place the operational amplifier into shutdown. The shutdown terminal threshold is always referenced to $V_{DD}/2$. Therefore, when operating the device with split supply voltages (e.g. $\pm 2.5\text{ V}$), the shutdown terminal needs to be pulled to V_{DD-} (not GND) to disable the operational amplifier.

The amplifier's output with a shutdown pulse is shown in Figure 48 through Figure 50. The amplifier is powered with a single 5-V supply and configured as a noninverting configuration with a gain of 5. The amplifier turnon and turnoff times are measured from the 50% point of the shutdown pulse to the 50% point of the output waveform. The times for the single, dual, and quad are listed in the data tables. The *bump* on the rising edge of the TLV2770 output waveform is due to the start-up circuit on the bias generator. For the dual and quad (TLV2773/5), this *bump* is attributed to the bias generator's start-up circuit as well as the crosstalk between the other channel(s), which are in shutdown.

Figure 55 and Figure 56 show the amplifier's forward and reverse isolation in shutdown. The operational amplifier is powered by $\pm 1.35\text{-V}$ supplies and configured as a voltage follower ($A_V = 1$). The isolation performance is plotted across frequency for both 0.1- V_{PP} and 2.7- V_{PP} input signals. During normal operation, the amplifier would not be able to handle a 2.7- V_{PP} input signal with a supply voltage of $\pm 1.35\text{ V}$ since it exceeds the common-mode input voltage range (V_{ICR}). However, this curve illustrates that the amplifier remains in shutdown even under a worst case scenario.

TLV277x-Q1, TLV277xA-Q1 FAMILY OF 2.7-V HIGH-SLEW-RATE RAIL-TO-RAIL OUTPUT OPERATIONAL AMPLIFIERS WITH SHUTDOWN

SGLS179D – SEPTEMBER 2003 – REVISED AUGUST 2008

APPLICATION INFORMATION

macromodel information

Macromodel information provided was derived using Microsim *Parts*™ Release 8, the model generation software used with Microsim *PSpice*™. The Boyle macromodel (see Note 4) and subcircuit in Figure 64 are generated using the TLV2772 typical electrical and operating characteristics at $T_A = 25^\circ\text{C}$. Using this information, output simulations of the following key parameters can be generated to a tolerance of 20% (in most cases):

- Maximum positive output voltage swing
- Maximum negative output voltage swing
- Slew rate
- Quiescent power dissipation
- Input bias current
- Open-loop voltage amplification
- Unity-gain frequency
- Common-mode rejection ratio
- Phase margin
- DC output resistance
- AC output resistance
- Short-circuit output current limit

NOTE 6: G. R. Boyle, B. M. Cohn, D. O. Pederson, and J. E. Solomon, "Macromodeling of Integrated Circuit Operational Amplifiers", *IEEE Journal of Solid-State Circuits*, SC-9, 353 (1974).

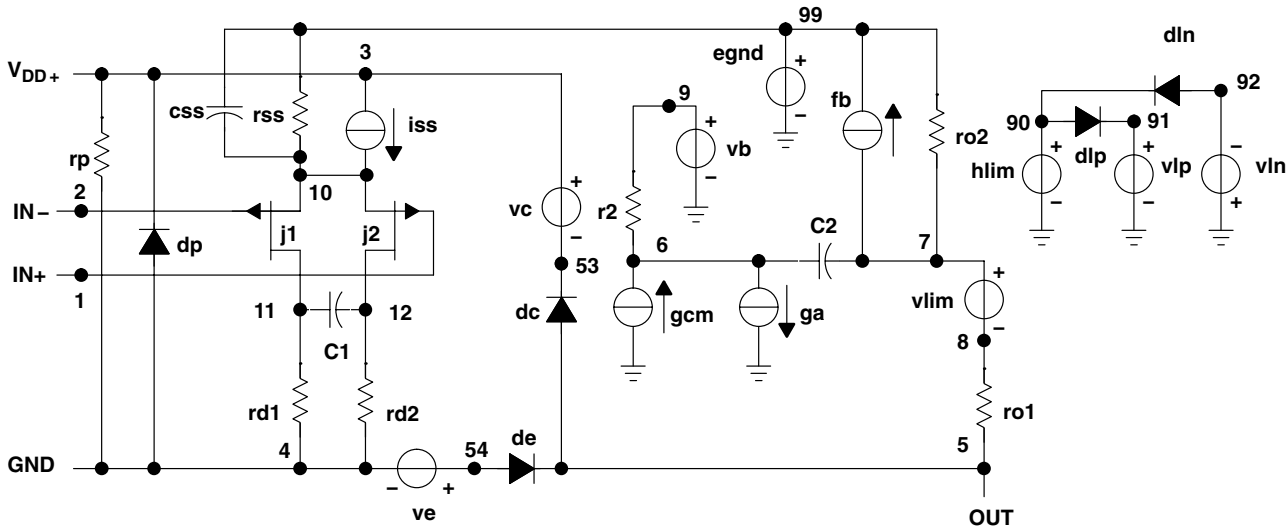

* TLV2772 operational amplifier macromodel subcircuit
 * created using Parts release 8.0 on 12/12/97 at 10:08
 * Parts is a MicroSim product.
 * connections: noninverting input
 * inverting input
 * positive power supply
 * negative power supply
 * output
 *.subckt TLV2772 1 2 3 4 5

| | | | |
|------|----|----|--|
| c1 | 11 | 12 | 2.8868E-12 |
| c2 | 6 | 7 | 10.000E-12 |
| css | 10 | 99 | 2.6302E-12 |
| dc | 5 | 53 | dy |
| de | 54 | 5 | dy |
| dlp | 90 | 91 | dx |
| dln | 92 | 90 | dx |
| dp | 4 | 3 | dx |
| egnd | 99 | 0 | poly(2) (3,0) (4,0) 0 .5 .5 |
| fb | 7 | 99 | poly(5) vb vc ve vlp vln 0 15.513E6 -1E3 1E3 16E6 -16E6 |
| ga | 6 | 0 | 11 12 188.50E-6 |
| gcm | 0 | 6 | 10 99 9.4472E-9 |

| | | | | |
|--------|-----|----|--|-----------|
| iss | 3 | 10 | dc | 145.50E-6 |
| hlim | 90 | 0 | vlim | 1K |
| j1 | 11 | 2 | 10 | jx1 |
| j2 | 12 | 1 | 10 | jx2 |
| r2 | 6 | 9 | 100.00E3 | |
| rd1 | 4 | 11 | 5.3052E3 | |
| rd2 | 4 | 12 | 5.3052E3 | |
| ro1 | 8 | 5 | 17.140 | |
| ro2 | 7 | 99 | 17.140 | |
| rp | 3 | 4 | 4.5455E3 | |
| rss | 10 | 99 | 1.3746E6 | |
| vb | 9 | 0 | dc | 0 |
| vc | 3 | 53 | dc | .82001 |
| ve | 54 | 4 | dc | .82001 |
| vlim | 7 | 8 | dc | 0 |
| vlp | 91 | 0 | dc | 47 |
| vln | 0 | 92 | dc | 47 |
| .model | dx | | D(Is=800.00E-18) | |
| .model | dy | | D(Is=800.00E-18 Rs=1m Cjo=10p) | |
| .model | jx1 | | PJF(Is=2.2500E-12 Beta=244.20E-6 + Vto=-.99765) | |
| .model | jx2 | | PJF(Is=1.7500E-12 Beta=244.20E-6 + Vto=-1.002350) | |
| .ends | | | | |

Figure 64. Boyle Macromodel and Subcircuit

PSpice and Parts are trademarks of MicroSim Corporation.



PACKAGING INFORMATION

| Orderable Device | Status (1) | Package Type | Package Drawing | Pins | Package Qty | Eco Plan (2) | Lead/Ball Finish | MSL Peak Temp (3) | Op Temp (°C) | Top-Side Markings (4) | Samples |
|------------------|---------------|--------------|-----------------|------|-------------|-------------------------|------------------|----------------------|--------------|--------------------------|-------------------------|
| TLV2771QDBVRQ1 | ACTIVE | SOT-23 | DBV | 5 | 3000 | Green (RoHS & no Sb/Br) | CU NIPDAU | Level-1-260C-UNLIM | -40 to 125 | VBPQ | Samples |
| TLV2772AQDRG4Q1 | ACTIVE | SOIC | D | 8 | 2500 | Green (RoHS & no Sb/Br) | CU NIPDAU | Level-1-260C-UNLIM | -40 to 125 | 2772AQ | Samples |
| TLV2772AQDRQ1 | ACTIVE | SOIC | D | 8 | 2500 | Green (RoHS & no Sb/Br) | CU NIPDAU | Level-1-260C-UNLIM | -40 to 125 | 2772AQ | Samples |
| TLV2772AQPWRG4Q1 | ACTIVE | TSSOP | PW | 8 | 2000 | Green (RoHS & no Sb/Br) | CU NIPDAU | Level-1-260C-UNLIM | -40 to 125 | 2772AQ | Samples |
| TLV2772AQPWRQ1 | OBSOLETE | TSSOP | PW | 8 | | TBD | Call TI | Call TI | -40 to 125 | 2772AQ | |
| TLV2772QDRG4Q1 | ACTIVE | SOIC | D | 8 | 2500 | Green (RoHS & no Sb/Br) | CU NIPDAU | Level-1-260C-UNLIM | -40 to 125 | 2772Q1 | Samples |
| TLV2772QDRQ1 | OBSOLETE | SOIC | D | 8 | | TBD | Call TI | Call TI | -40 to 125 | 2772Q1 | |
| TLV2772QPWRG4Q1 | ACTIVE | TSSOP | PW | 8 | 2000 | Green (RoHS & no Sb/Br) | CU NIPDAU | Level-1-260C-UNLIM | -40 to 125 | 2772Q1 | Samples |
| TLV2772QPWRQ1 | ACTIVE | TSSOP | PW | 8 | 2000 | Green (RoHS & no Sb/Br) | CU NIPDAU | Level-1-260C-UNLIM | -40 to 125 | 2772Q1 | Samples |

(1) The marketing status values are defined as follows:

ACTIVE: Product device recommended for new designs.

LIFEBUY: TI has announced that the device will be discontinued, and a lifetime-buy period is in effect.

NRND: Not recommended for new designs. Device is in production to support existing customers, but TI does not recommend using this part in a new design.

PREVIEW: Device has been announced but is not in production. Samples may or may not be available.

OBSOLETE: TI has discontinued the production of the device.

(2) Eco Plan - The planned eco-friendly classification: Pb-Free (RoHS), Pb-Free (RoHS Exempt), or Green (RoHS & no Sb/Br) - please check <http://www.ti.com/productcontent> for the latest availability information and additional product content details.

TBD: The Pb-Free/Green conversion plan has not been defined.

Pb-Free (RoHS): TI's terms "Lead-Free" or "Pb-Free" mean semiconductor products that are compatible with the current RoHS requirements for all 6 substances, including the requirement that lead not exceed 0.1% by weight in homogeneous materials. Where designed to be soldered at high temperatures, TI Pb-Free products are suitable for use in specified lead-free processes.

Pb-Free (RoHS Exempt): This component has a RoHS exemption for either 1) lead-based flip-chip solder bumps used between the die and package, or 2) lead-based die adhesive used between the die and leadframe. The component is otherwise considered Pb-Free (RoHS compatible) as defined above.

Green (RoHS & no Sb/Br): TI defines "Green" to mean Pb-Free (RoHS compatible), and free of Bromine (Br) and Antimony (Sb) based flame retardants (Br or Sb do not exceed 0.1% by weight in homogeneous material)

(3) MSL, Peak Temp. -- The Moisture Sensitivity Level rating according to the JEDEC industry standard classifications, and peak solder temperature.

⁽⁴⁾ Multiple Top-Side Markings will be inside parentheses. Only one Top-Side Marking contained in parentheses and separated by a "-" will appear on a device. If a line is indented then it is a continuation of the previous line and the two combined represent the entire Top-Side Marking for that device.

Important Information and Disclaimer:The information provided on this page represents TI's knowledge and belief as of the date that it is provided. TI bases its knowledge and belief on information provided by third parties, and makes no representation or warranty as to the accuracy of such information. Efforts are underway to better integrate information from third parties. TI has taken and continues to take reasonable steps to provide representative and accurate information but may not have conducted destructive testing or chemical analysis on incoming materials and chemicals. TI and TI suppliers consider certain information to be proprietary, and thus CAS numbers and other limited information may not be available for release.

In no event shall TI's liability arising out of such information exceed the total purchase price of the TI part(s) at issue in this document sold by TI to Customer on an annual basis.

OTHER QUALIFIED VERSIONS OF TLV2771-Q1, TLV2772-Q1, TLV2772A-Q1 :

- Catalog: [TLV2771](#), [TLV2772](#), [TLV2772A](#)

- Enhanced Product: [TLV2772A-EP](#)

- Military: [TLV2772M](#), [TLV2772AM](#)

NOTE: Qualified Version Definitions:

- Catalog - TI's standard catalog product

- Enhanced Product - Supports Defense, Aerospace and Medical Applications

- Military - QML certified for Military and Defense Applications

TAPE AND REEL INFORMATION



QUADRANT ASSIGNMENTS FOR PIN 1 ORIENTATION IN TAPE



*All dimensions are nominal

| Device | Package Type | Package Drawing | Pins | SPQ | Reel Diameter (mm) | Reel Width W1 (mm) | A0 (mm) | B0 (mm) | K0 (mm) | P1 (mm) | W (mm) | Pin1 Quadrant |
|------------------|--------------|-----------------|------|------|--------------------|--------------------|---------|---------|---------|---------|--------|---------------|
| TLV2771QDBVRQ1 | SOT-23 | DBV | 5 | 3000 | 180.0 | 9.0 | 3.15 | 3.2 | 1.4 | 4.0 | 8.0 | Q3 |
| TLV2772AQPWRG4Q1 | TSSOP | PW | 8 | 2000 | 330.0 | 12.4 | 7.0 | 3.6 | 1.6 | 8.0 | 12.0 | Q1 |

TAPE AND REEL BOX DIMENSIONS

*All dimensions are nominal

| Device | Package Type | Package Drawing | Pins | SPQ | Length (mm) | Width (mm) | Height (mm) |
|------------------|--------------|-----------------|------|------|-------------|------------|-------------|
| TLV2771QDBVRQ1 | SOT-23 | DBV | 5 | 3000 | 182.0 | 182.0 | 20.0 |
| TLV2772AQPWRG4Q1 | TSSOP | PW | 8 | 2000 | 367.0 | 367.0 | 35.0 |

DBV (R-PDSO-G5)

PLASTIC SMALL-OUTLINE PACKAGE



- NOTES:
- A. All linear dimensions are in millimeters.
 - B. This drawing is subject to change without notice.
 - C. Body dimensions do not include mold flash or protrusion. Mold flash and protrusion shall not exceed 0.15 per side.
 - D. Falls within JEDEC MO-178 Variation AA.

DBV (R-PDSO-G5)

PLASTIC SMALL OUTLINE

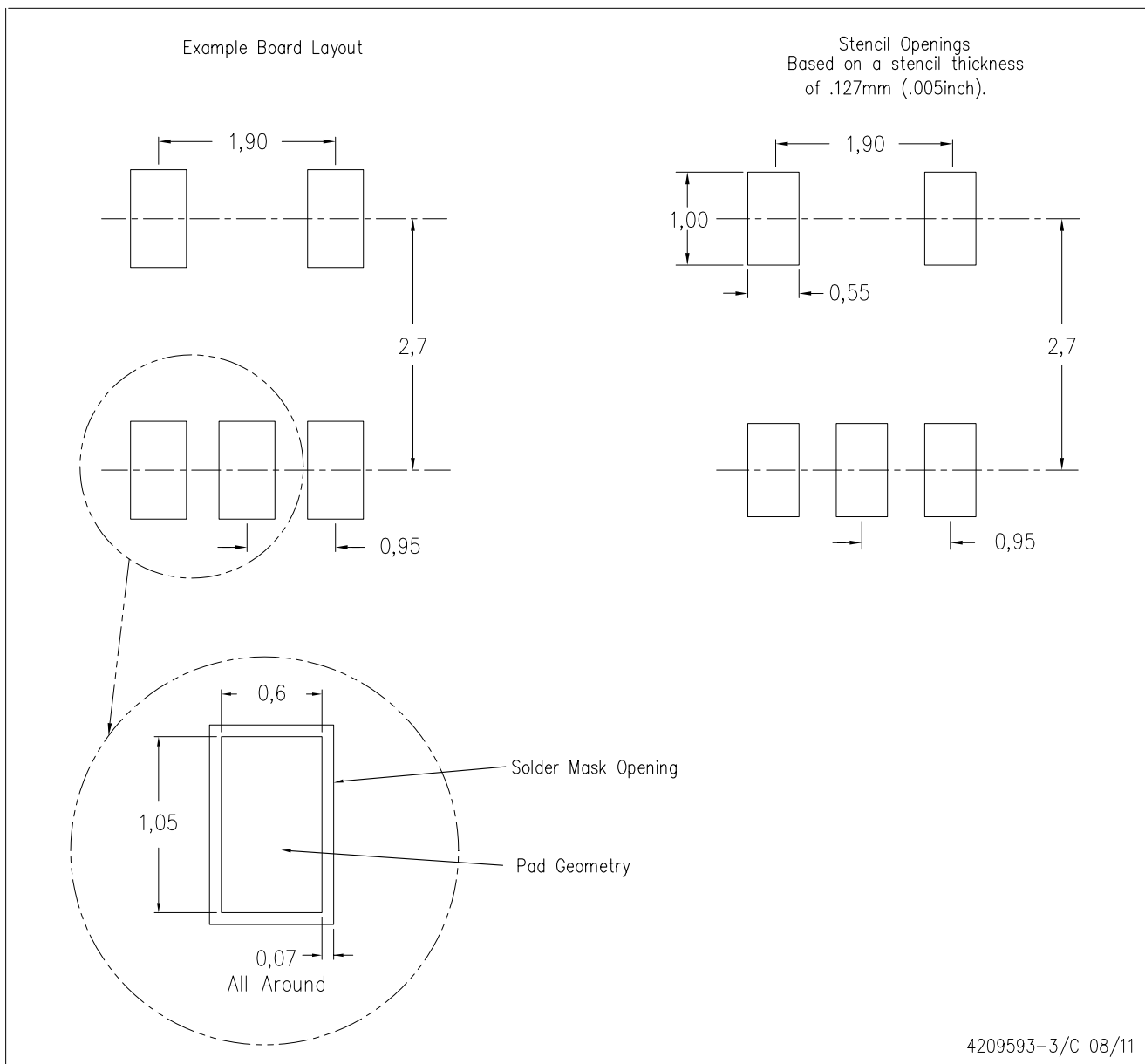

- NOTES:
- A. All linear dimensions are in millimeters.
 - B. This drawing is subject to change without notice.
 - C. Customers should place a note on the circuit board fabrication drawing not to alter the center solder mask defined pad.
 - D. Publication IPC-7351 is recommended for alternate designs.
 - E. Laser cutting apertures with trapezoidal walls and also rounding corners will offer better paste release. Customers should contact their board assembly site for stencil design recommendations. Example stencil design based on a 50% volumetric metal load solder paste. Refer to IPC-7525 for other stencil recommendations.

D (R-PDSO-G8)

PLASTIC SMALL OUTLINE



- NOTES:
- A. All linear dimensions are in inches (millimeters).
 - B. This drawing is subject to change without notice.
 - C. Body length does not include mold flash, protrusions, or gate burrs. Mold flash, protrusions, or gate burrs shall not exceed 0.006 (0,15) each side.
 - D. Body width does not include interlead flash. Interlead flash shall not exceed 0.017 (0,43) each side.
 - E. Reference JEDEC MS-012 variation AA.

D (R-PDSO-G8)

PLASTIC SMALL OUTLINE



- NOTES:
- A. All linear dimensions are in millimeters.
 - B. This drawing is subject to change without notice.
 - C. Publication IPC-7351 is recommended for alternate designs.
 - D. Laser cutting apertures with trapezoidal walls and also rounding corners will offer better paste release. Customers should contact their board assembly site for stencil design recommendations. Refer to IPC-7525 for other stencil recommendations.
 - E. Customers should contact their board fabrication site for solder mask tolerances between and around signal pads.

IMPORTANT NOTICE

Texas Instruments Incorporated and its subsidiaries (TI) reserve the right to make corrections, enhancements, improvements and other changes to its semiconductor products and services per JESD46, latest issue, and to discontinue any product or service per JESD48, latest issue. Buyers should obtain the latest relevant information before placing orders and should verify that such information is current and complete. All semiconductor products (also referred to herein as "components") are sold subject to TI's terms and conditions of sale supplied at the time of order acknowledgment.

TI warrants performance of its components to the specifications applicable at the time of sale, in accordance with the warranty in TI's terms and conditions of sale of semiconductor products. Testing and other quality control techniques are used to the extent TI deems necessary to support this warranty. Except where mandated by applicable law, testing of all parameters of each component is not necessarily performed.

TI assumes no liability for applications assistance or the design of Buyers' products. Buyers are responsible for their products and applications using TI components. To minimize the risks associated with Buyers' products and applications, Buyers should provide adequate design and operating safeguards.

TI does not warrant or represent that any license, either express or implied, is granted under any patent right, copyright, mask work right, or other intellectual property right relating to any combination, machine, or process in which TI components or services are used. Information published by TI regarding third-party products or services does not constitute a license to use such products or services or a warranty or endorsement thereof. Use of such information may require a license from a third party under the patents or other intellectual property of the third party, or a license from TI under the patents or other intellectual property of TI.

Reproduction of significant portions of TI information in TI data books or data sheets is permissible only if reproduction is without alteration and is accompanied by all associated warranties, conditions, limitations, and notices. TI is not responsible or liable for such altered documentation. Information of third parties may be subject to additional restrictions.

Resale of TI components or services with statements different from or beyond the parameters stated by TI for that component or service voids all express and any implied warranties for the associated TI component or service and is an unfair and deceptive business practice. TI is not responsible or liable for any such statements.

Buyer acknowledges and agrees that it is solely responsible for compliance with all legal, regulatory and safety-related requirements concerning its products, and any use of TI components in its applications, notwithstanding any applications-related information or support that may be provided by TI. Buyer represents and agrees that it has all the necessary expertise to create and implement safeguards which anticipate dangerous consequences of failures, monitor failures and their consequences, lessen the likelihood of failures that might cause harm and take appropriate remedial actions. Buyer will fully indemnify TI and its representatives against any damages arising out of the use of any TI components in safety-critical applications.

In some cases, TI components may be promoted specifically to facilitate safety-related applications. With such components, TI's goal is to help enable customers to design and create their own end-product solutions that meet applicable functional safety standards and requirements. Nonetheless, such components are subject to these terms.

No TI components are authorized for use in FDA Class III (or similar life-critical medical equipment) unless authorized officers of the parties have executed a special agreement specifically governing such use.

Only those TI components which TI has specifically designated as military grade or "enhanced plastic" are designed and intended for use in military/aerospace applications or environments. Buyer acknowledges and agrees that any military or aerospace use of TI components which have **not** been so designated is solely at the Buyer's risk, and that Buyer is solely responsible for compliance with all legal and regulatory requirements in connection with such use.

TI has specifically designated certain components as meeting ISO/TS16949 requirements, mainly for automotive use. In any case of use of non-designated products, TI will not be responsible for any failure to meet ISO/TS16949.

Products

| | |
|------------------------------|--|
| Audio | www.ti.com/audio |
| Amplifiers | amplifier.ti.com |
| Data Converters | dataconverter.ti.com |
| DLP® Products | www.dlp.com |
| DSP | dsp.ti.com |
| Clocks and Timers | www.ti.com/clocks |
| Interface | interface.ti.com |
| Logic | logic.ti.com |
| Power Mgmt | power.ti.com |
| Microcontrollers | microcontroller.ti.com |
| RFID | www.ti-rfid.com |
| OMAP Applications Processors | www.ti.com/omap |
| Wireless Connectivity | www.ti.com/wirelessconnectivity |

Applications

| | |
|-------------------------------|--|
| Automotive and Transportation | www.ti.com/automotive |
| Communications and Telecom | www.ti.com/communications |
| Computers and Peripherals | www.ti.com/computers |
| Consumer Electronics | www.ti.com/consumer-apps |
| Energy and Lighting | www.ti.com/energy |
| Industrial | www.ti.com/industrial |
| Medical | www.ti.com/medical |
| Security | www.ti.com/security |
| Space, Avionics and Defense | www.ti.com/space-avionics-defense |
| Video and Imaging | www.ti.com/video |

TI E2E Community

e2e.ti.com