

# TLV2371-EP, TLV2372-EP, TLV2374-EP FAMILY OF 550- $\mu$ A/Ch 3-MHz RAIL-TO-RAIL INPUT/OUTPUT OPERATIONAL AMPLIFIERS

SGLS306A – APRIL 2005 – REVISED APRIL 2006

- **Controlled Baseline**
  - One Assembly/Test Site, One Fabrication Site
- **Extended Temperature Performance of –55°C to 125°C**
- **Enhanced Diminishing Manufacturing Sources (DMS) Support**
- **Enhanced Product-Change Notification**
- **Qualification Pedigree†**
- **Rail-To-Rail Input/Output**
- **Wide Bandwidth . . . 3 MHz**
- **High Slew Rate . . . 2.4 V/ $\mu$ s**
- **Supply Voltage Range . . . 2.7 V to 16 V**
- **Supply Current . . . 550  $\mu$ A/Channel**
- **Input Noise Voltage . . . 39 nV/ $\sqrt{\text{Hz}}$**
- **Input Bias Current . . . 1 pA**
- **Specified Temperature Range –55°C to 125°C**
- **Ultrasmall Packaging**
  - 5-Pin SOT-23 (TLV2371)
  - 8-Pin MSOP (TLV2372)

† Component qualification in accordance with JEDEC and industry standards to ensure reliable operation over an extended temperature range. This includes, but is not limited to, Highly Accelerated Stress Test (HAST) or biased 85/85, temperature cycle, autoclave or unbiased HAST, electromigration, bond intermetallic life, and mold compound life. Such qualification testing should not be viewed as justifying use of this component beyond specified performance and environmental limits.

Operational Amplifier

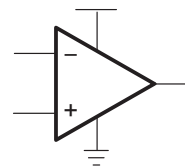

## description

The TLV237x single supply operational amplifiers provide rail-to-rail input and output capability. The TLV237x takes the minimum operating supply voltage down to 2.7 V over the extended automotive temperature range while adding the rail-to-rail output swing feature. The TLV237x also provides 3-MHz bandwidth from only 550  $\mu$ A. The maximum recommended supply voltage is 16 V, which allows the devices to be operated from ( $\pm$ 8 V supplies down to  $\pm$ 1.35 V) a variety of rechargeable cells.

The CMOS inputs enable use in high-impedance sensor interfaces, with the lower voltage operation making an ideal alternative for the TLC227x in battery-powered applications. The rail-to-rail input stage further increases its versatility. The TLV237x is the seventh member of a rapidly growing number of RRIO products available from Texas Instruments and it is the first to allow operation up to 16-V rails with good ac performance.

The 2.7-V operation makes the TLV237x compatible with Li-Ion powered systems and the operating supply voltage range of many micro-power microcontrollers available today including Texas Instruments' MSP430.

### SELECTION OF SIGNAL AMPLIFIER PRODUCTST

DEVICE	V <sub>DD</sub> (V)	V <sub>IO</sub> ( $\mu$ V)	I <sub>q</sub> /Ch ( $\mu$ A)	I <sub>IB</sub> (pA)	GBW (MHz)	SR (V/ $\mu$ s)	SHUTDOWN	RAIL-TO-RAIL	SINGLES/DUALS/QUADS
TLV237x	2.7–16	500	550	1	3	2.4	Yes	I/O	S/D/Q
TLC227x	4–16	300	1100	1	2.2	3.6	—	O	D/Q
TLV27x	2.7–16	500	550	1	3	2.4	—	O	S/D/Q
TLC27x	3–16	1100	675	1	1.7	3.6	—	—	S/D/Q
TLV246x	2.7–6	150	550	1300	6.4	1.6	Yes	I/O	S/D/Q
TLV247x	2.7–6	250	600	2	2.8	1.5	Yes	I/O	S/D/Q
TLV244x	2.7–10	300	725	1	1.8	1.4	—	O	D/Q

† Typical values measured at 5 V, 25°C



Please be aware that an important notice concerning availability, standard warranty, and use in critical applications of Texas Instruments semiconductor products and disclaimers thereto appears at the end of this data sheet.

**PRODUCTION DATA** information is current as of publication date. Products conform to specifications per the terms of Texas Instruments standard warranty. Production processing does not necessarily include testing of all parameters.



POST OFFICE BOX 655303 • DALLAS, TEXAS 75265  
POST OFFICE BOX 1443 • HOUSTON, TEXAS 77251-1443

Copyright © 2006, Texas Instruments Incorporated

# TLV2371-EP, TLV2372-EP, TLV2374-EP FAMILY OF 550- $\mu$ A/Ch 3-MHz RAIL-TO-RAIL INPUT/OUTPUT OPERATIONAL AMPLIFIERS

SGLS306A – APRIL 2005 – REVISED APRIL 2006

FAMILY PACKAGE TABLE

DEVICE	NUMBER OF CHANNELS	PACKAGE TYPES				UNIVERSAL EVM BOARD
		SOIC	SOT-23	TSSOP	MSOP	
TLV2371	1	8	5	—	—	See the EVM Selection Guide (SLOU060)
TLV2372	2	8	—	—	8	
TLV2374	4	14	—	14	—	

TLV2371 AVAILABLE OPTIONS

T <sub>A</sub>	V <sub>IO</sub> MAX AT 25°C	PACKAGED DEVICES		
		SMALL OUTLINE (D)	SOT-23	
			(DBV)	SYMBOL
-55°C to 125°C	4.5 mV	TLV2371MDREP†	TLV2371MDBVREP	371E

TLV2372 AVAILABLE OPTIONS

T <sub>A</sub>	V <sub>IO</sub> MAX AT 25°C	PACKAGED DEVICES		
		SMALL OUTLINE (D)	MSOP	
			(DGK)	SYMBOL
-55°C to 125°C	4.5 mV	TLV2372MDREP†	TLV2372MDGKREP†	

† Product Preview

TLV2374 AVAILABLE OPTIONS

T <sub>A</sub>	V <sub>IO</sub> MAX AT 25°C	PACKAGED DEVICES	
		SMALL OUTLINE (D)	TSSOP (PW)
-55°C to 125°C	4.5 mV	TLV2374MDREP	TLV2374MPWREP†

† Product Preview

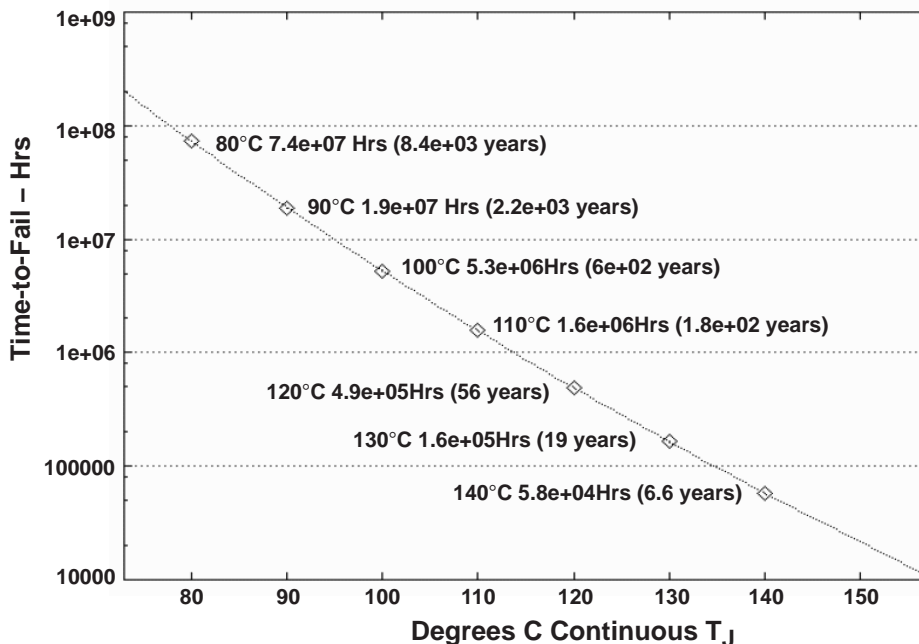

Figure 1. Wirebond Life Plot



# TLV2371-EP, TLV2372-EP, TLV2374-EP FAMILY OF 550- $\mu$ A/Ch 3-MHz RAIL-TO-RAIL INPUT/OUTPUT OPERATIONAL AMPLIFIERS

SGLS306A – APRIL 2005 – REVISED APRIL 2006

## TLV237x PACKAGE PINOUTS(1)

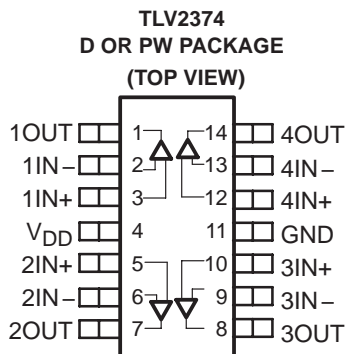
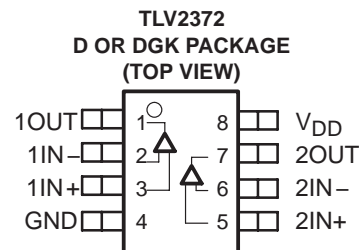
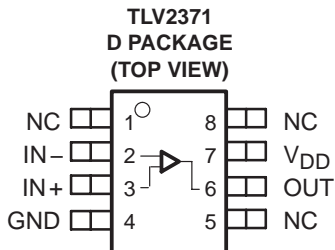
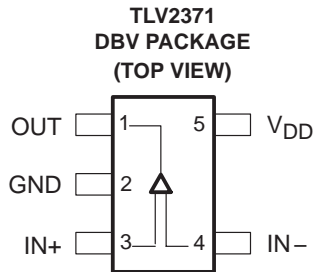

NC – No internal connection

(1) SOT-23 may or may not be indicated

### TYPICAL PIN 1 INDICATORS

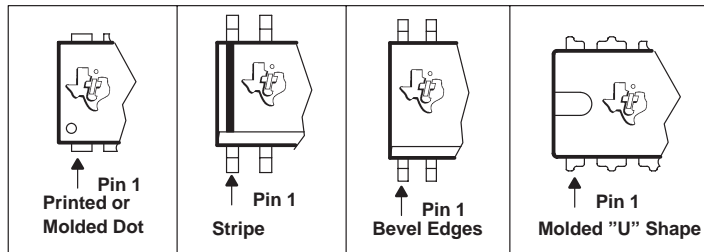

**TLV2371-EP, TLV2372-EP, TLV2374-EP**  
**FAMILY OF 550- $\mu$ A/Ch 3-MHz RAIL-TO-RAIL INPUT/OUTPUT**  
**OPERATIONAL AMPLIFIERS**

SGLS306A – APRIL 2005 – REVISED APRIL 2006

**absolute maximum ratings over operating free-air temperature range (unless otherwise noted)†**

Supply voltage, $V_{DD}$ (see Note 1)	16.5 V
Differential input voltage, $V_{ID}$	$\pm V_{DD}$
Input voltage range, $V_I$ (see Note 1)	-0.2 V to $V_{DD} + 0.2$ V
Input current range, $I_I$	$\pm 10$ mA
Output current range, $I_O$	$\pm 100$ mA
Package thermal impedance, $\theta_{JA}$ (see Notes 2 and 3):	
D (8-pin) package	176°C/W
D (14-pin) package	122.3°C/W
D (16-pin) package	114.7°C/W
DBV (5-pin) package	324.1°C/W
DGK (8-pin) package	259.96°C/W
PW (14-pin) package	173.6°C/W
Operating free-air temperature range, $T_A$	-55°C to 125°C
Maximum junction temperature, $T_J$	150°C
Storage temperature range, $T_{stg}$	-65°C to 150°C
Lead temperature 1,6 mm (1/16 inch) from case for 10 seconds	260°C

† Stresses beyond those listed under “absolute maximum ratings” may cause permanent damage to the device. These are stress ratings only, and functional operation of the device at these or any other conditions beyond those indicated under “recommended operating conditions” is not implied. Exposure to absolute-maximum-rated conditions for extended periods may affect device reliability.

- NOTES: 1. All voltage values, except differential voltages, are with respect to GND.  
 2. Maximum power dissipation is a function of  $T_{J(max)}$ ,  $\theta_{JA}$ , and  $T_A$ . The maximum allowable power dissipation at any allowable ambient temperature is  $P_D = (T_{J(max)} - T_A)/\theta_{JA}$ . Selecting the maximum of 150°C can affect reliability.  
 3. The package thermal impedance is calculated in accordance with JESD 51-7.

**recommended operating conditions**

		MIN	MAX	UNIT
Supply voltage, $V_{DD}$	Single supply	2.7	16	V
	Split supply	$\pm 1.35$	$\pm 8$	
Common-mode input voltage range, $V_{ICR}$		0	$V_{DD}$	V
Turnon voltage level, $V_{(ON)}$ , relative to GND pin voltage			2	V
Turnoff voltage level, $V_{(OFF)}$ , relative to GND pin voltage		0.8		V
Operating free-air temperature, $T_A$	M-suffix	-55	125	°C



**TLV2371-EP, TLV2372-EP, TLV2374-EP**  
**FAMILY OF 550- $\mu$ A/Ch 3-MHz RAIL-TO-RAIL INPUT/OUTPUT**  
**OPERATIONAL AMPLIFIERS**

SGLS306A – APRIL 2005 – REVISED APRIL 2006

electrical characteristics at specified free-air temperature,  $V_{DD} = 2.7\text{ V}$ ,  $5\text{ V}$ , and  $15\text{ V}$  (unless otherwise noted)

**dc performance**

PARAMETER		TEST CONDITIONS		$T_A$	MIN	TYP	MAX	UNIT
$V_{IO}$	Input offset voltage	$V_{IC} = V_{DD}/2,$ $R_S = 50\ \Omega$	$V_O = V_{DD}/2,$	25°C		2	4.5	mV
				Full range			6	
$\alpha_{VIO}$	Offset voltage drift			25°C		2		$\mu\text{V}/^\circ\text{C}$
CMRR	Common-mode rejection ratio	$V_{IC} = 0\text{ to }V_{DD},$ $R_S = 50\ \Omega$	$V_{DD} = 2.7\text{ V}$	25°C	50	68	dB	
				Full range	47			
				25°C	53	70		
				Full range	50			
				25°C	55	72		
				Full range	54			
		$V_{IC} = 0\text{ to }V_{DD}-1.35\text{ V},$ $R_S = 50\ \Omega,$	$V_{DD} = 5\text{ V}$	25°C	58	80		
				Full range	54			
				25°C	64	82		
				Full range	63			
				25°C	67	84		
				Full range	66			
$V_{IC} = 0\text{ to }V_{DD},$ $R_S = 50\ \Omega,$	$V_{DD} = 15\text{ V}$	25°C	95	106				
		Full range	60					
		25°C	80	110				
		Full range	78					
		25°C	77	83				
		Full range	73					
$A_{VD}$	Large-signal differential voltage amplification	$V_{O(PP)} = V_{DD}/2,$ $R_L = 10\text{ k}\Omega$	$V_{DD} = 2.7\text{ V}$	25°C	95	106	dB	
				Full range	60			
				25°C	80	110		
				Full range	78			
				25°C	77	83		
				Full range	73			

**input characteristics**

PARAMETER		TEST CONDITIONS		$T_A$	MIN	TYP	MAX	UNIT
$I_{IO}$	Input offset current	$V_{DD} = 15\text{ V},$	$V_{IC} = V_{DD}/2,$	25°C		1	60	pA
				125°C			1000	
$I_{IB}$	Input bias current	$V_O = V_{DD}/2$		25°C		1	60	pA
				125°C			1000	
$r_{i(d)}$	Differential input resistance			25°C		1000		G $\Omega$
$C_{IC}$	Common-mode input capacitance		$f = 21\text{ kHz}$	25°C		8		pF



**TLV2371-EP, TLV2372-EP, TLV2374-EP**  
**FAMILY OF 550- $\mu$ A/Ch 3-MHz RAIL-TO-RAIL INPUT/OUTPUT**  
**OPERATIONAL AMPLIFIERS**

SGLS306A – APRIL 2005 – REVISED APRIL 2006

electrical characteristics at specified free-air temperature,  $V_{DD} = 2.7\text{ V}$ ,  $5\text{ V}$ , and  $15\text{ V}$  (unless otherwise noted) (continued)

**output characteristics**

PARAMETER	TEST CONDITIONS	$T_A$	MIN	TYP	MAX	UNIT
$V_{OH}$ High-level output voltage	$V_{IC} = V_{DD}/2, I_{OH} = -1\text{ mA}$	$V_{DD} = 2.7\text{ V}$	25°C	2.55	2.58	V
			Full range	2.48		
		$V_{DD} = 5\text{ V}$	25°C	4.9	4.93	
			Full range	4.85		
		$V_{DD} = 15\text{ V}$	25°C	14.92	14.96	
			Full range	14.9		
	$V_{IC} = V_{DD}/2, I_{OH} = -5\text{ mA}$	$V_{DD} = 2.7\text{ V}$	25°C	1.88	2	
			Full range	1.42		
		$V_{DD} = 5\text{ V}$	25°C	4.58	4.68	
			Full range	4.44		
		$V_{DD} = 15\text{ V}$	25°C	14.7	14.8	
			Full range	14.6		
$V_{OL}$ Low-level output voltage	$V_{IC} = V_{DD}/2, I_{OL} = 1\text{ mA}$	$V_{DD} = 2.7\text{ V}$	25°C	0.1	0.15	V
			Full range		0.22	
		$V_{DD} = 5\text{ V}$	25°C	0.05	0.1	
			Full range		0.15	
		$V_{DD} = 15\text{ V}$	25°C	0.05	0.08	
			Full range		0.1	
	$V_{IC} = V_{DD}/2, I_{OL} = 5\text{ mA}$	$V_{DD} = 2.7\text{ V}$	25°C	0.52	0.7	
			Full range		1.15	
		$V_{DD} = 5\text{ V}$	25°C	0.28	0.4	
			Full range		0.54	
		$V_{DD} = 15\text{ V}$	25°C	0.19	0.3	
			Full range		0.35	

**power supply**

PARAMETER	TEST CONDITIONS	$T_A$	MIN	TYP	MAX	UNIT
$I_{DD}$ Supply current (per channel)	$V_O = V_{DD}/2,$	$V_{DD} = 2.7\text{ V}$	25°C	470	560	$\mu\text{A}$
			$V_{DD} = 5\text{ V}$	25°C	550	
		$V_{DD} = 15\text{ V}$	25°C	750	900	
			Full range		1200	
PSRR Supply voltage rejection ratio ( $\Delta V_{DD}/\Delta V_{IO}$ )	$V_{DD} = 2.7\text{ V to }15\text{ V},$ No load	$V_{IC} = V_{DD}/2,$	25°C	70	80	dB
			Full range	65		



**TLV2371-EP, TLV2372-EP, TLV2374-EP**  
**FAMILY OF 550- $\mu$ A/Ch 3-MHz RAIL-TO-RAIL INPUT/OUTPUT**  
**OPERATIONAL AMPLIFIERS**

SGLS306A – APRIL 2005 – REVISED APRIL 2006

electrical characteristics at specified free-air temperature,  $V_{DD} = 2.7\text{ V}$ ,  $5\text{ V}$ , and  $15\text{ V}$  (unless otherwise noted) (continued)

**dynamic performance**

PARAMETER		TEST CONDITIONS		$T_A$	MIN	TYP	MAX	UNIT
UGBW	Unity gain bandwidth	$R_L = 2\text{ k}\Omega$ , $C_L = 10\text{ pF}$	$V_{DD} = 2.7\text{ V}$	$25^\circ\text{C}$	2.4		3	MHz
			$V_{DD} = 5\text{ V to }15\text{ V}$	$25^\circ\text{C}$				
SR	Slew rate at unity gain	$V_{O(PP)} = V_{DD}/2$ , $C_L = 50\text{ pF}$ , $R_L = 10\text{ k}\Omega$	$V_{DD} = 2.7\text{ V}$	$25^\circ\text{C}$	1.4	2	1	V/ $\mu$ s
				Full range				
			$V_{DD} = 5\text{ V}$	$25^\circ\text{C}$	1.4	2.4	1.1	V/ $\mu$ s
				Full range				
			$V_{DD} = 15\text{ V}$	$25^\circ\text{C}$	1.9	2.1	1.2	V/ $\mu$ s
				Full range				
$\phi_m$	Phase margin	$R_L = 2\text{ k}\Omega$ ,	$C_L = 100\text{ pF}$	$25^\circ\text{C}$	65°			
	Gain margin	$R_L = 2\text{ k}\Omega$ ,	$C_L = 10\text{ pF}$	$25^\circ\text{C}$	18		dB	
$t_s$	Settling time	$V_{DD} = 2.7\text{ V}$ , $V_{(STEP)PP} = 1\text{ V}$ , $A_V = -1$ , $C_L = 10\text{ pF}$ , $R_L = 2\text{ k}\Omega$	0.1%	$25^\circ\text{C}$	2.9		$\mu$ s	
			$V_{DD} = 5\text{ V, }15\text{ V}$ , $V_{(STEP)PP} = 1\text{ V}$ , $A_V = -1$ , $C_L = 47\text{ pF}$ , $R_L = 2\text{ k}\Omega$		0.1%	2		

**noise/distortion performance**

PARAMETER		TEST CONDITIONS		$T_A$	MIN	TYP	MAX	UNIT
THD + N	Total harmonic distortion plus noise	$V_{DD} = 2.7\text{ V}$ , $V_{O(PP)} = V_{DD}/2\text{ V}$ , $R_L = 2\text{ k}\Omega$ , $f = 10\text{ kHz}$	$A_V = 1$	$25^\circ\text{C}$	0.02%			
			$A_V = 10$		0.05%			
			$A_V = 100$		0.18%			
			$V_{DD} = 5\text{ V, }5\text{ V}$ , $V_{O(PP)} = V_{DD}/2\text{ V}$ , $R_L = 2\text{ k}\Omega$ , $f = 10\text{ kHz}$	$A_V = 1$	$25^\circ\text{C}$	0.02%		
				$A_V = 10$		0.09%		
				$A_V = 100$		0.5%		
$V_n$	Equivalent input noise voltage	$f = 1\text{ kHz}$	$f = 10\text{ kHz}$	$25^\circ\text{C}$	39		nV/ $\sqrt{\text{Hz}}$	
					35			
$I_n$	Equivalent input noise current	$f = 1\text{ kHz}$		$25^\circ\text{C}$	0.6		fA/ $\sqrt{\text{Hz}}$	



**TLV2371-EP, TLV2372-EP, TLV2374-EP**  
**FAMILY OF 550- $\mu$ A/Ch 3-MHz RAIL-TO-RAIL INPUT/OUTPUT**  
**OPERATIONAL AMPLIFIERS**

SGLS306A – APRIL 2005 – REVISED APRIL 2006

**TYPICAL CHARACTERISTICS**

**Table of Graphs**

			<b>FIGURE</b>
$V_{IO}$	Input offset voltage	vs Common-mode input voltage	1, 2, 3
CMRR	Common-mode rejection ratio	vs Frequency	4
	Input bias and offset current	vs Free-air temperature	5
$V_{OL}$	Low-level output voltage	vs Low-level output current	6, 8, 10
$V_{OH}$	High-level output voltage	vs High-level output current	7, 9, 11
$V_{O(PP)}$	Peak-to-peak output voltage	vs Frequency	12
$I_{DD}$	Supply current	vs Supply voltage	13
PSRR	Power supply rejection ratio	vs Frequency	14
$A_{VD}$	Differential voltage gain & phase	vs Frequency	15
	Gain-bandwidth product	vs Free-air temperature	16
SR	Slew rate	vs Supply voltage	17
		vs Free-air temperature	18
$\phi_m$	Phase margin	vs Capacitive load	19
$V_n$	Equivalent input noise voltage	vs Frequency	20
	Voltage-follower large-signal pulse response		21, 22
	Voltage-follower small-signal pulse response		23
	Inverting large-signal response		24, 25
	Inverting small-signal response		26
	Crosstalk	vs Frequency	27





# TLV2371-EP, TLV2372-EP, TLV2374-EP FAMILY OF 550- $\mu$ A/Ch 3-MHz RAIL-TO-RAIL INPUT/OUTPUT OPERATIONAL AMPLIFIERS

SGLS306A – APRIL 2005 – REVISED APRIL 2006

## TYPICAL CHARACTERISTICS

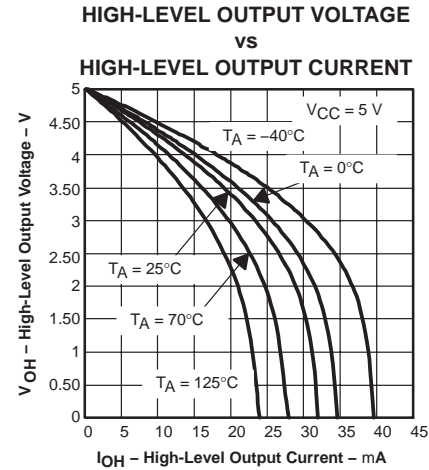
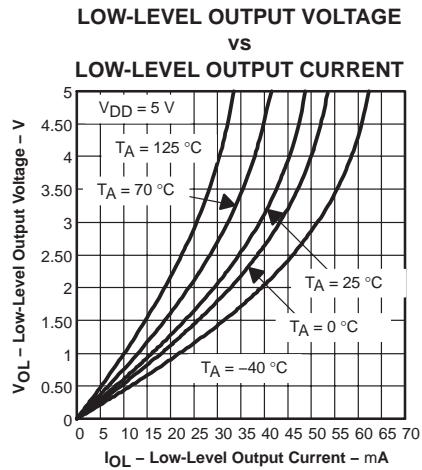
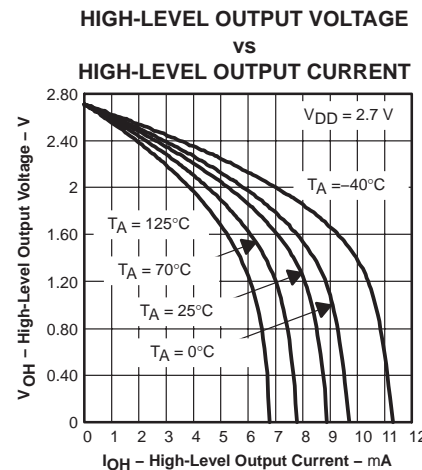
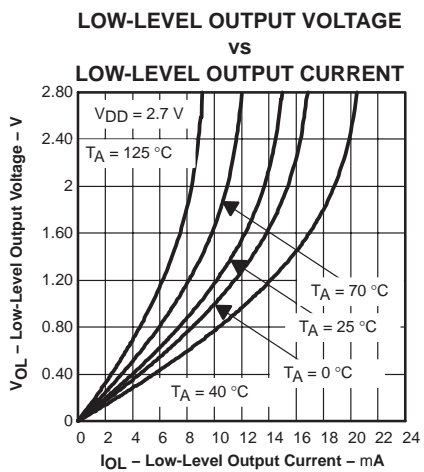
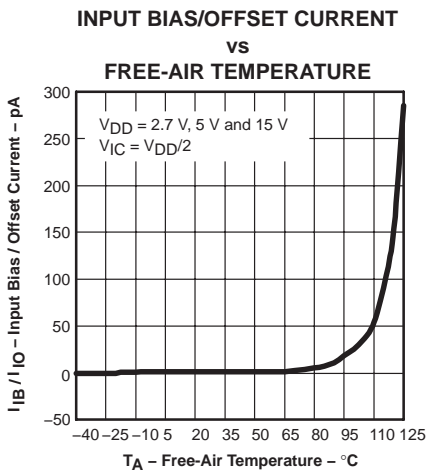
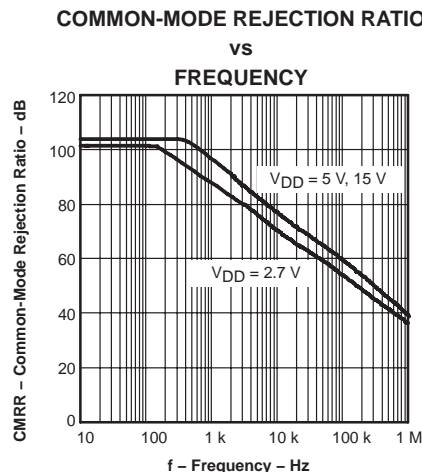
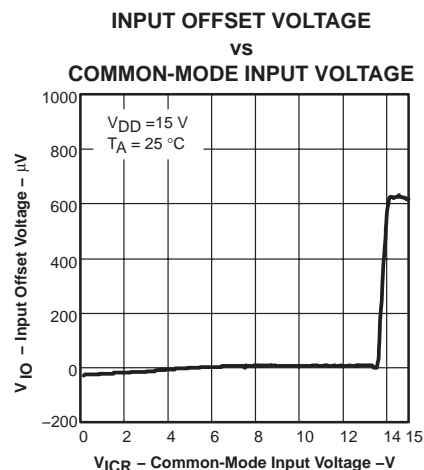
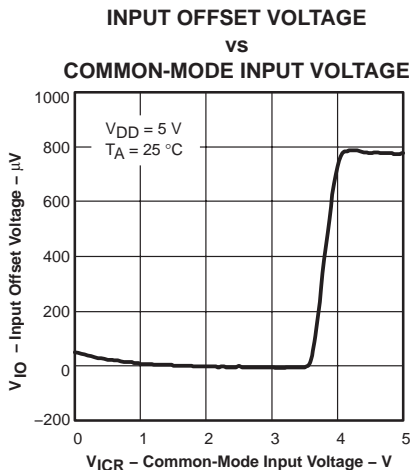
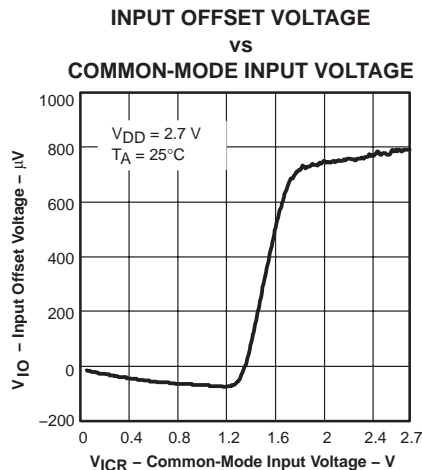

# TLV2371-EP, TLV2372-EP, TLV2374-EP FAMILY OF 550- $\mu$ A/Ch 3-MHz RAIL-TO-RAIL INPUT/OUTPUT OPERATIONAL AMPLIFIERS

SGLS306A – APRIL 2005 – REVISED APRIL 2006

## TYPICAL CHARACTERISTICS

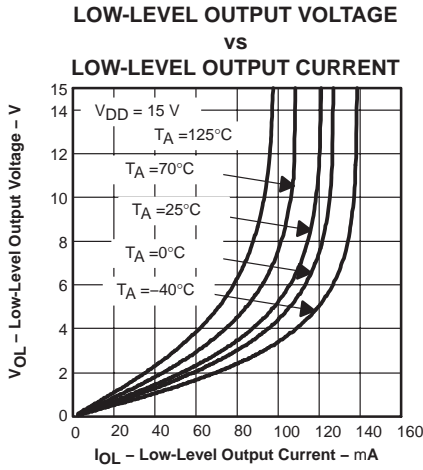

Figure 11

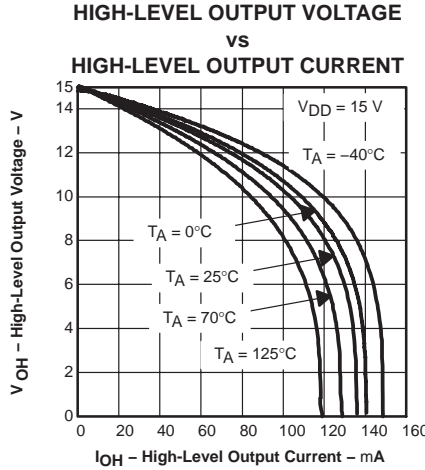

Figure 12

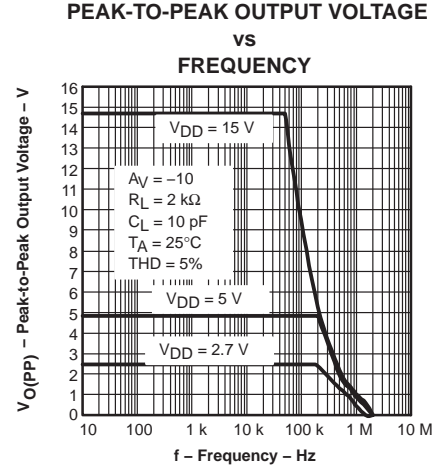

Figure 13

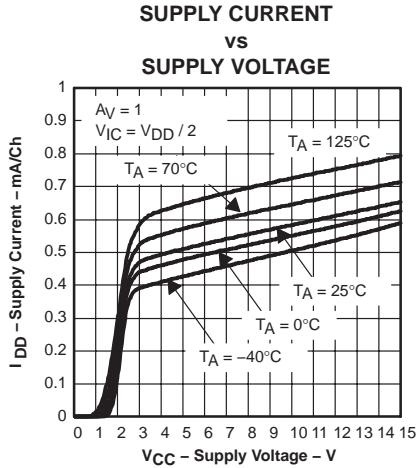

Figure 14

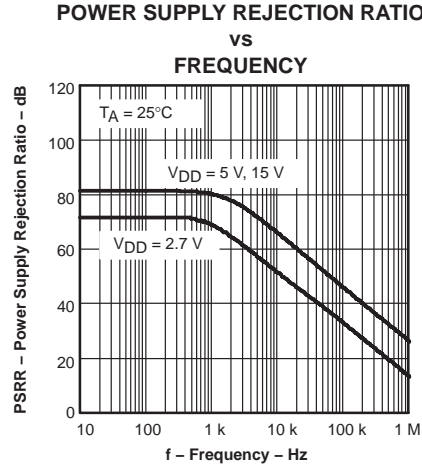

Figure 15

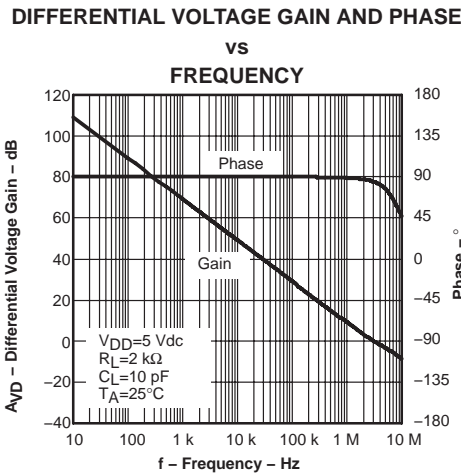

Figure 16

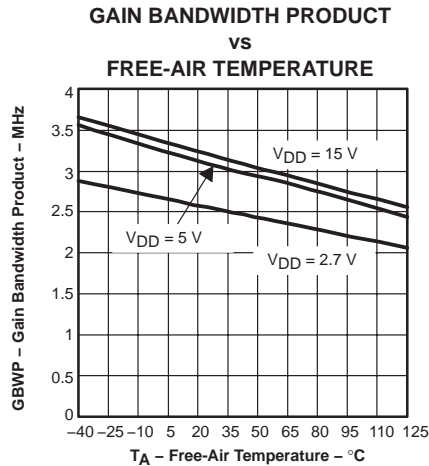

Figure 17



# TLV2371-EP, TLV2372-EP, TLV2374-EP FAMILY OF 550- $\mu$ A/Ch 3-MHz RAIL-TO-RAIL INPUT/OUTPUT OPERATIONAL AMPLIFIERS

SGLS306A – APRIL 2005 – REVISED APRIL 2006

## TYPICAL CHARACTERISTICS

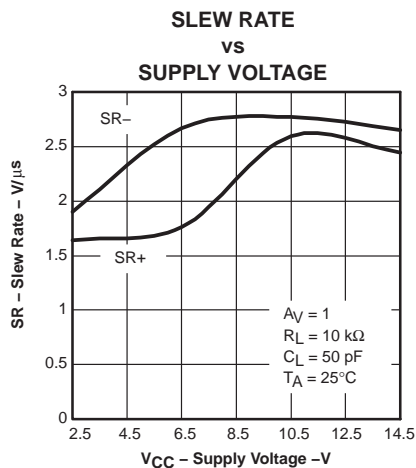

Figure 18

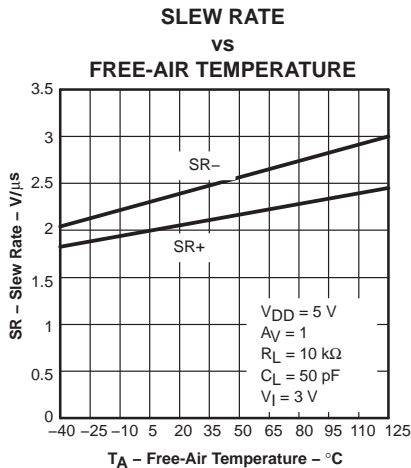

Figure 19

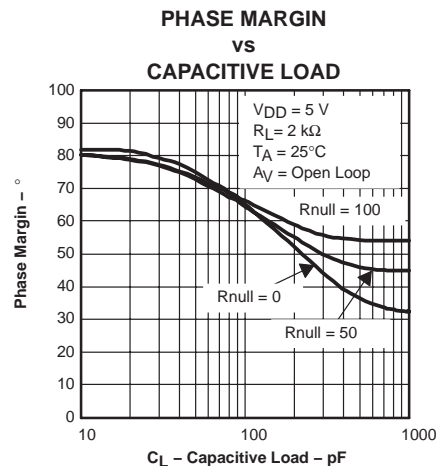

Figure 20

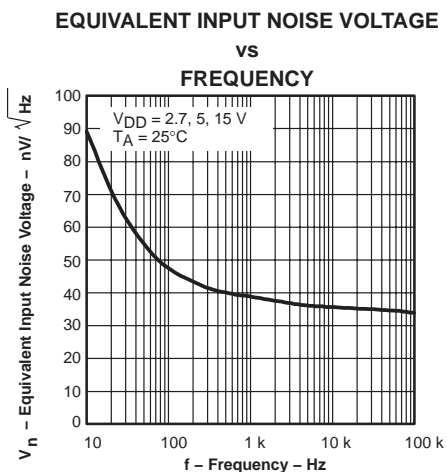

Figure 21

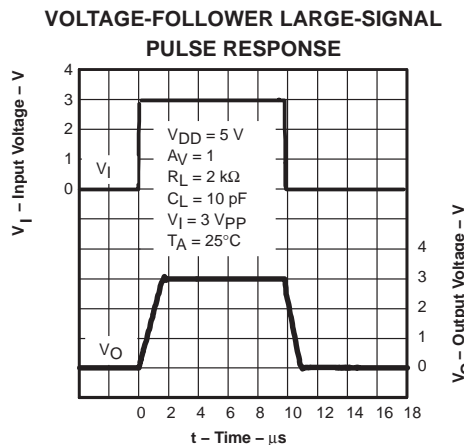

Figure 22

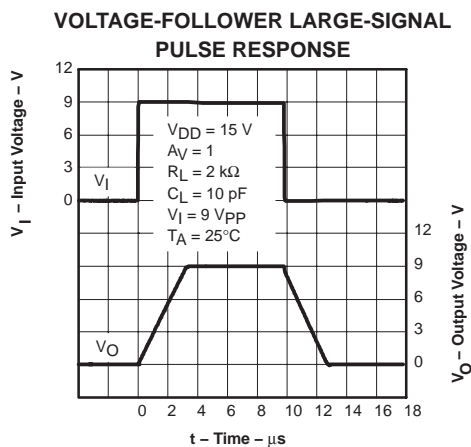

Figure 23

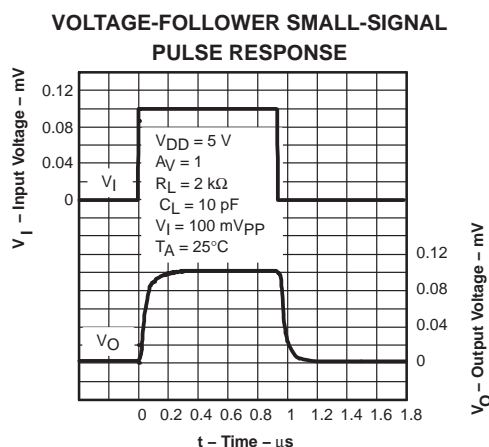

Figure 24



# TLV2371-EP, TLV2372-EP, TLV2374-EP FAMILY OF 550- $\mu$ A/Ch 3-MHz RAIL-TO-RAIL INPUT/OUTPUT OPERATIONAL AMPLIFIERS

SGLS306A – APRIL 2005 – REVISED APRIL 2006

## TYPICAL CHARACTERISTICS

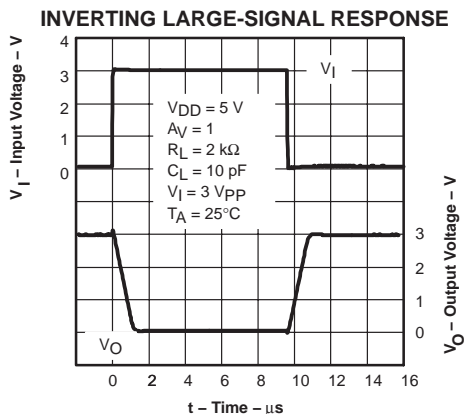

Figure 25

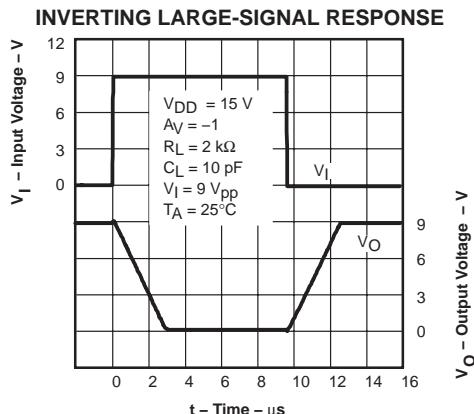

Figure 26

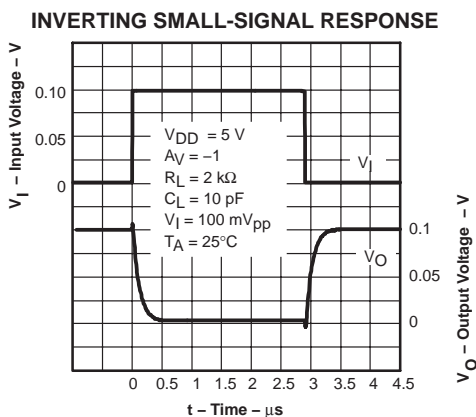

Figure 27

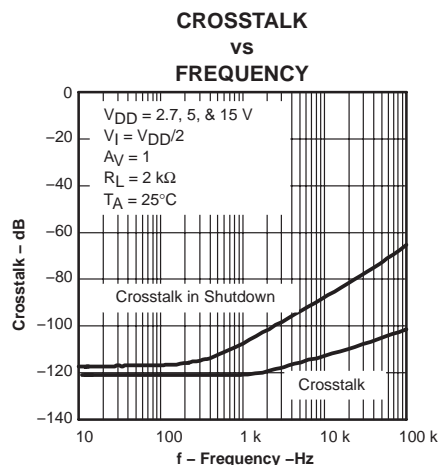

Figure 28

## APPLICATION INFORMATION

### rail-to-rail input operation

The TLV237x input stage consists of two differential transistor pairs, NMOS and PMOS, that operate together to achieve rail-to-rail input operation. The transition point between these two pairs can be seen in Figure 2 through Figure 4 for a 2.7-V, 5-V, and 15-V supply. As the common-mode input voltage approaches the positive supply rail, the input pair switches from the PMOS differential pair to the NMOS differential pair. This transition occurs approximately 1.35 V from the positive rail and results in a change in offset voltage due to different device characteristics between the NMOS and PMOS pairs. If the input signal to the device is large enough to swing between both rails, this transition results in a reduction in common-mode rejection ratio (CMRR). If the input signal does not swing between both rails, it is best to bias the signal in the region where only one input pair is active. This is the region in Figure 2 through Figure 4 where the offset voltage varies slightly across the input range and optimal CMRR can be achieved. This has the greatest impact when operating from a 2.7-V supply voltage.

### driving a capacitive load

When the amplifier is configured in this manner, capacitive loading directly on the output decreases the device's phase margin, leading to high frequency ringing or oscillations. Therefore, for capacitive loads of greater than 10 pF, it is recommended that a resistor be placed in series ( $R_{NULL}$ ) with the output of the amplifier, as shown in Figure 29. A minimum value of 20  $\Omega$  should work well for most applications.

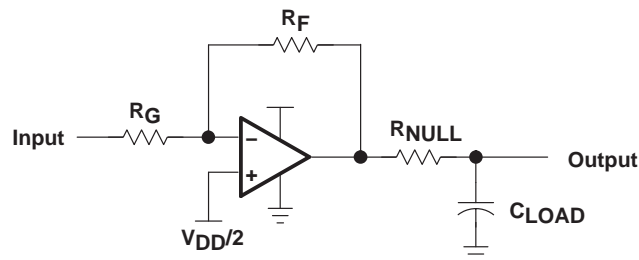

**Figure 29. Driving a Capacitive Load**

### offset voltage

The output offset voltage, ( $V_{OO}$ ) is the sum of the input offset voltage ( $V_{IO}$ ) and both input bias currents ( $I_{IB}$ ) times the corresponding gains. The schematic and formula in Figure 30 can be used to calculate the output offset voltage.

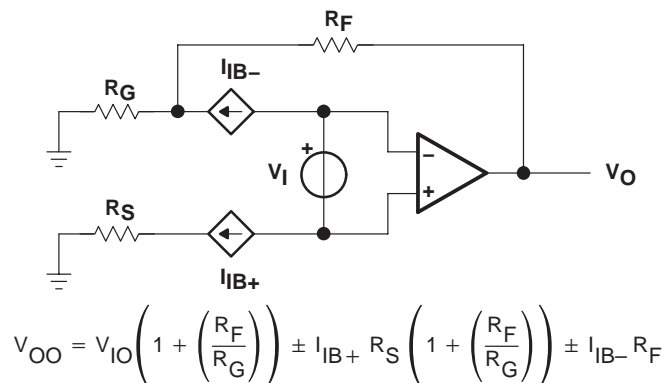
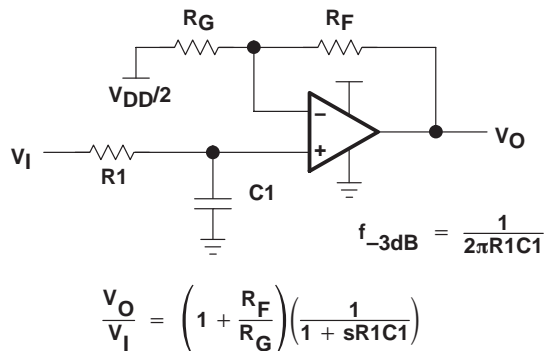

**Figure 30. Output Offset Voltage Model**

**APPLICATION INFORMATION**

**general configurations**

When receiving low-level signals, limiting the bandwidth of the incoming signals into the system is often required. The simplest way to accomplish this is to place an RC filter at the noninverting terminal of the amplifier (see Figure 31).



**Figure 31. Single-Pole Low-Pass Filter**

If even more attenuation is needed, a multiple pole filter is required. The Sallen-Key filter can be used for this task. For best results, the amplifier should have a bandwidth that is 8 to 10 times the filter frequency bandwidth. Failure to do this can result in phase shift of the amplifier.

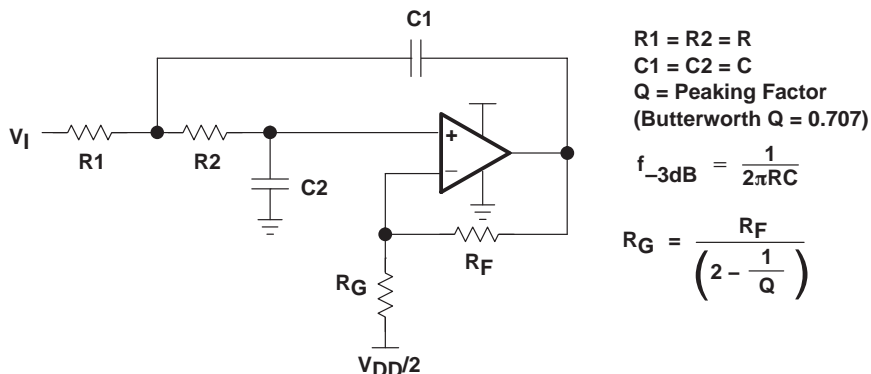

**Figure 32. 2-Pole Low-Pass Sallen-Key Filter**

---

## APPLICATION INFORMATION

### circuit layout considerations

To achieve the levels of high performance of the TLV237x, follow proper printed-circuit board design techniques. The following is a general set of guidelines.

- Ground planes—It is highly recommended that a ground plane be used on the board to provide all components with a low inductive ground connection. However, in the areas of the amplifier inputs and output, the ground plane can be removed to minimize the stray capacitance.
- Proper power supply decoupling—Use a 6.8- $\mu$ F tantalum capacitor in parallel with a 0.1- $\mu$ F ceramic capacitor on each supply terminal. It may be possible to share the tantalum capacitor among several amplifiers depending on the application, but a 0.1- $\mu$ F ceramic capacitor should always be used on the supply terminal of every amplifier. In addition, the 0.1- $\mu$ F capacitor should be placed as close as possible to the supply terminal. As this distance increases, the inductance in the connecting trace makes the capacitor less effective. The designer should strive for distances of less than 0.1 inches between the device power terminals and the ceramic capacitors.
- Sockets—Sockets can be used but are not recommended. The additional lead inductance in the socket pins often leads to stability problems. Surface-mount packages soldered directly to the printed-circuit board is the best implementation.
- Short trace runs/compact part placements—Optimum high performance is achieved when stray series inductance has been minimized. To realize this, the circuit layout should be made as compact as possible, thereby minimizing the length of all trace runs. Particular attention should be paid to the inverting input of the amplifier. Its length should be kept as short as possible. This helps to minimize stray capacitance at the input of the amplifier.
- Surface-mount passive components—Using surface-mount passive components is recommended for high performance amplifier circuits for several reasons. First, because of the extremely low lead inductance of surface-mount components, the problem with stray series inductance is greatly reduced. Second, the small size of surface-mount components naturally leads to a more compact layout thereby minimizing both stray inductance and capacitance. If leaded components are used, it is recommended that the lead lengths be kept as short as possible.

**TLV2371-EP, TLV2372-EP, TLV2374-EP**  
**FAMILY OF 550-μA/Ch 3-MHz RAIL-TO-RAIL INPUT/OUTPUT**  
**OPERATIONAL AMPLIFIERS**

SGLS306A – APRIL 2005 – REVISED APRIL 2006

**APPLICATION INFORMATION**

**general power dissipation considerations**

For a given  $\theta_{JA}$ , the maximum power dissipation is shown in Figure 33 and is calculated by the following formula:

$$P_D = \left( \frac{T_{MAX} - T_A}{\theta_{JA}} \right)$$

Where:

- $P_D$  = Maximum power dissipation of TLV237x IC (watts)
- $T_{MAX}$  = Absolute maximum junction temperature (150°C)
- $T_A$  = Free-ambient air temperature (°C)
- $\theta_{JA}$  =  $\theta_{JC} + \theta_{CA}$
- $\theta_{JC}$  = Thermal coefficient from junction to case
- $\theta_{CA}$  = Thermal coefficient from case to ambient air (°C/W)

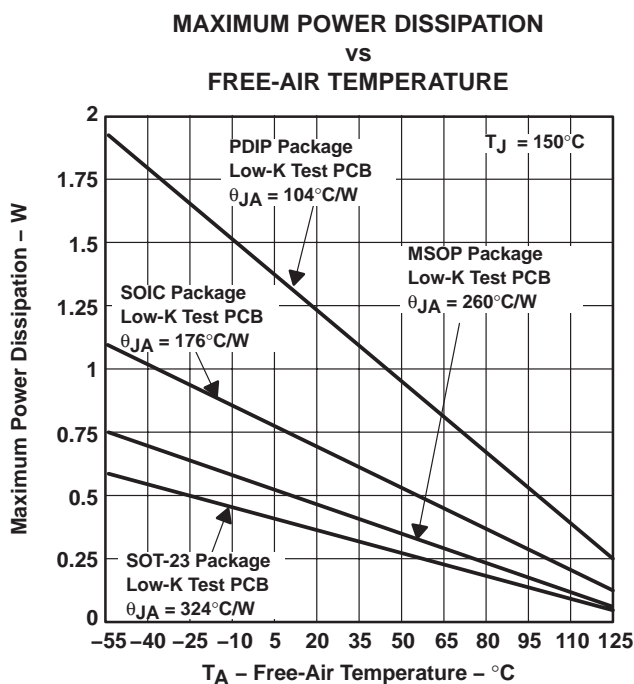

NOTE A: Results are with no air flow and using JEDEC Standard Low-K test PCB.

**Figure 33.**





**TAPE AND REEL INFORMATION**



**QUADRANT ASSIGNMENTS FOR PIN 1 ORIENTATION IN TAPE**



\*All dimensions are nominal

Device	Package Type	Package Drawing	Pins	SPQ	Reel Diameter (mm)	Reel Width W1 (mm)	A0 (mm)	B0 (mm)	K0 (mm)	P1 (mm)	W (mm)	Pin1 Quadrant
TLV2371MDBVREP	SOT-23	DBV	5	3000	180.0	9.0	3.15	3.2	1.4	4.0	8.0	Q3
TLV2374MDREP	SOIC	D	14	2500	330.0	16.4	6.5	9.0	2.1	8.0	16.0	Q1

**TAPE AND REEL BOX DIMENSIONS**



\*All dimensions are nominal

Device	Package Type	Package Drawing	Pins	SPQ	Length (mm)	Width (mm)	Height (mm)
TLV2371MDBVREP	SOT-23	DBV	5	3000	182.0	182.0	20.0
TLV2374MDREP	SOIC	D	14	2500	333.2	345.9	28.6

DBV (R-PDSO-G5)

PLASTIC SMALL-OUTLINE PACKAGE



- NOTES:
- A. All linear dimensions are in millimeters.
  - B. This drawing is subject to change without notice.
  - C. Body dimensions do not include mold flash or protrusion. Mold flash and protrusion shall not exceed 0.15 per side.
  - D. Falls within JEDEC MO-178 Variation AA.

D (R-PDSO-G14)

PLASTIC SMALL OUTLINE



- NOTES:
- A. All linear dimensions are in inches (millimeters).
  - B. This drawing is subject to change without notice.
  - $\triangle C$  Body length does not include mold flash, protrusions, or gate burrs. Mold flash, protrusions, or gate burrs shall not exceed 0.006 (0,15) each side.
  - $\triangle D$  Body width does not include interlead flash. Interlead flash shall not exceed 0.017 (0,43) each side.
  - E. Reference JEDEC MS-012 variation AB.

D (R-PDSO-G14)

PLASTIC SMALL OUTLINE



- NOTES:
- A. All linear dimensions are in millimeters.
  - B. This drawing is subject to change without notice.
  - C. Publication IPC-7351 is recommended for alternate designs.
  - D. Laser cutting apertures with trapezoidal walls and also rounding corners will offer better paste release. Customers should contact their board assembly site for stencil design recommendations. Refer to IPC-7525 for other stencil recommendations.
  - E. Customers should contact their board fabrication site for solder mask tolerances between and around signal pads.

## IMPORTANT NOTICE

Texas Instruments Incorporated and its subsidiaries (TI) reserve the right to make corrections, enhancements, improvements and other changes to its semiconductor products and services per JESD46, latest issue, and to discontinue any product or service per JESD48, latest issue. Buyers should obtain the latest relevant information before placing orders and should verify that such information is current and complete. All semiconductor products (also referred to herein as "components") are sold subject to TI's terms and conditions of sale supplied at the time of order acknowledgment.

TI warrants performance of its components to the specifications applicable at the time of sale, in accordance with the warranty in TI's terms and conditions of sale of semiconductor products. Testing and other quality control techniques are used to the extent TI deems necessary to support this warranty. Except where mandated by applicable law, testing of all parameters of each component is not necessarily performed.

TI assumes no liability for applications assistance or the design of Buyers' products. Buyers are responsible for their products and applications using TI components. To minimize the risks associated with Buyers' products and applications, Buyers should provide adequate design and operating safeguards.

TI does not warrant or represent that any license, either express or implied, is granted under any patent right, copyright, mask work right, or other intellectual property right relating to any combination, machine, or process in which TI components or services are used. Information published by TI regarding third-party products or services does not constitute a license to use such products or services or a warranty or endorsement thereof. Use of such information may require a license from a third party under the patents or other intellectual property of the third party, or a license from TI under the patents or other intellectual property of TI.

Reproduction of significant portions of TI information in TI data books or data sheets is permissible only if reproduction is without alteration and is accompanied by all associated warranties, conditions, limitations, and notices. TI is not responsible or liable for such altered documentation. Information of third parties may be subject to additional restrictions.

Resale of TI components or services with statements different from or beyond the parameters stated by TI for that component or service voids all express and any implied warranties for the associated TI component or service and is an unfair and deceptive business practice. TI is not responsible or liable for any such statements.

Buyer acknowledges and agrees that it is solely responsible for compliance with all legal, regulatory and safety-related requirements concerning its products, and any use of TI components in its applications, notwithstanding any applications-related information or support that may be provided by TI. Buyer represents and agrees that it has all the necessary expertise to create and implement safeguards which anticipate dangerous consequences of failures, monitor failures and their consequences, lessen the likelihood of failures that might cause harm and take appropriate remedial actions. Buyer will fully indemnify TI and its representatives against any damages arising out of the use of any TI components in safety-critical applications.

In some cases, TI components may be promoted specifically to facilitate safety-related applications. With such components, TI's goal is to help enable customers to design and create their own end-product solutions that meet applicable functional safety standards and requirements. Nonetheless, such components are subject to these terms.

No TI components are authorized for use in FDA Class III (or similar life-critical medical equipment) unless authorized officers of the parties have executed a special agreement specifically governing such use.

Only those TI components which TI has specifically designated as military grade or "enhanced plastic" are designed and intended for use in military/aerospace applications or environments. Buyer acknowledges and agrees that any military or aerospace use of TI components which have **not** been so designated is solely at the Buyer's risk, and that Buyer is solely responsible for compliance with all legal and regulatory requirements in connection with such use.

TI has specifically designated certain components as meeting ISO/TS16949 requirements, mainly for automotive use. In any case of use of non-designated products, TI will not be responsible for any failure to meet ISO/TS16949.

### Products

Audio	<a href="http://www.ti.com/audio">www.ti.com/audio</a>
Amplifiers	<a href="http://amplifier.ti.com">amplifier.ti.com</a>
Data Converters	<a href="http://dataconverter.ti.com">dataconverter.ti.com</a>
DLP® Products	<a href="http://www.dlp.com">www.dlp.com</a>
DSP	<a href="http://dsp.ti.com">dsp.ti.com</a>
Clocks and Timers	<a href="http://www.ti.com/clocks">www.ti.com/clocks</a>
Interface	<a href="http://interface.ti.com">interface.ti.com</a>
Logic	<a href="http://logic.ti.com">logic.ti.com</a>
Power Mgmt	<a href="http://power.ti.com">power.ti.com</a>
Microcontrollers	<a href="http://microcontroller.ti.com">microcontroller.ti.com</a>
RFID	<a href="http://www.ti-rfid.com">www.ti-rfid.com</a>
OMAP Applications Processors	<a href="http://www.ti.com/omap">www.ti.com/omap</a>
Wireless Connectivity	<a href="http://www.ti.com/wirelessconnectivity">www.ti.com/wirelessconnectivity</a>

### Applications

Automotive and Transportation	<a href="http://www.ti.com/automotive">www.ti.com/automotive</a>
Communications and Telecom	<a href="http://www.ti.com/communications">www.ti.com/communications</a>
Computers and Peripherals	<a href="http://www.ti.com/computers">www.ti.com/computers</a>
Consumer Electronics	<a href="http://www.ti.com/consumer-apps">www.ti.com/consumer-apps</a>
Energy and Lighting	<a href="http://www.ti.com/energy">www.ti.com/energy</a>
Industrial	<a href="http://www.ti.com/industrial">www.ti.com/industrial</a>
Medical	<a href="http://www.ti.com/medical">www.ti.com/medical</a>
Security	<a href="http://www.ti.com/security">www.ti.com/security</a>
Space, Avionics and Defense	<a href="http://www.ti.com/space-avionics-defense">www.ti.com/space-avionics-defense</a>
Video and Imaging	<a href="http://www.ti.com/video">www.ti.com/video</a>

### TI E2E Community

[e2e.ti.com](http://e2e.ti.com)