

## 12-Bit, 1-MSPS, MICRO-POWER, MINIATURE SAR ANALOG-TO-DIGITAL CONVERTERS

Check for Samples: [ADS7886](#)

### FEATURES

- 1-MHz Sample Rate Serial Device
- 12-Bit Resolution
- Zero Latency
- 20-MHz Serial Interface
- Supply Range: 2.35 V to 5.25 V
- Typical Power Dissipation at 1 MSPS:
  - 3.9 mW at 3-V  $V_{DD}$
  - 7.5 mW at 5-V  $V_{DD}$
- INL  $\pm 1.25$  LSB Maximum,  $\pm 0.65$  LSB (Typical)
- DNL  $\pm 1$  LSB Maximum, +0.4 / -0.65 LSB (Typical)
- Typical AC Performance:  
72.25 dB SINAD, -84 dB THD
- Unipolar Input Range: 0 V to  $V_{DD}$
- Power Down Current: 1  $\mu$ A
- Wide Input Bandwidth: 15 MHz at 3 dB
- 6-Pin SOT23 and SC70 Packages

### APPLICATIONS

- Base Band Converters in Radio Communication
- Motor Current/Bus Voltage Sensors in Digital Drives
- Optical Networking (DWDM, MEMS Based Switching)
- Optical Sensors
- Battery Powered Systems
- Medical Instrumentations
- High-Speed Data Acquisition Systems
- High-Speed Closed-Loop Systems

### DESCRIPTION

The ADS7886 is a 12-bit, 1-MSPS analog-to-digital converter (ADC). The device includes a capacitor based SAR A/D converter with inherent sample and hold. The serial interface in each device is controlled by the  $\overline{CS}$  and SCLK signals for glueless connections with microprocessors and DSPs. The input signal is sampled with the falling edge of  $\overline{CS}$ , and SCLK is used for conversion and serial data output.

The device operates from a wide supply range from 2.35 V to 5.25 V. The low power consumption of the device makes it suitable for battery-powered applications. The device also includes a powerdown feature for power saving at lower conversion speeds.

The high level of the digital input to the device is not limited to device  $V_{DD}$ . This means the digital input can go as high as 5.25 V when device supply is 2.35 V. This feature is useful when digital signals are coming from other circuit with different supply levels. Also this relaxes restriction on power up sequencing.

The ADS7886 is available in 6-pin SOT23 and SC70 packages and is specified for operation from -40°C to 125°C.

**Table 1. Micro-Power Miniature SAR Converter Family**

BIT	< 300 KSPS	300 KSPS – 1.25 MSPS
12-Bit	ADS7866 (1.2 $V_{DD}$ to 3.6 $V_{DD}$ )	ADS7886 (2.35 $V_{DD}$ to 5.25 $V_{DD}$ )
10-Bit	ADS7867 (1.2 $V_{DD}$ to 3.6 $V_{DD}$ )	ADS7887 (2.35 $V_{DD}$ to 5.25 $V_{DD}$ )
8-Bit	ADS7868 (1.2 $V_{DD}$ to 3.6 $V_{DD}$ )	ADS7888 (2.35 $V_{DD}$ to 5.25 $V_{DD}$ )



Please be aware that an important notice concerning availability, standard warranty, and use in critical applications of Texas Instruments semiconductor products and disclaimers thereto appears at the end of this data sheet.



This integrated circuit can be damaged by ESD. Texas Instruments recommends that all integrated circuits be handled with appropriate precautions. Failure to observe proper handling and installation procedures can cause damage.

ESD damage can range from subtle performance degradation to complete device failure. Precision integrated circuits may be more susceptible to damage because very small parametric changes could cause the device not to meet its published specifications.

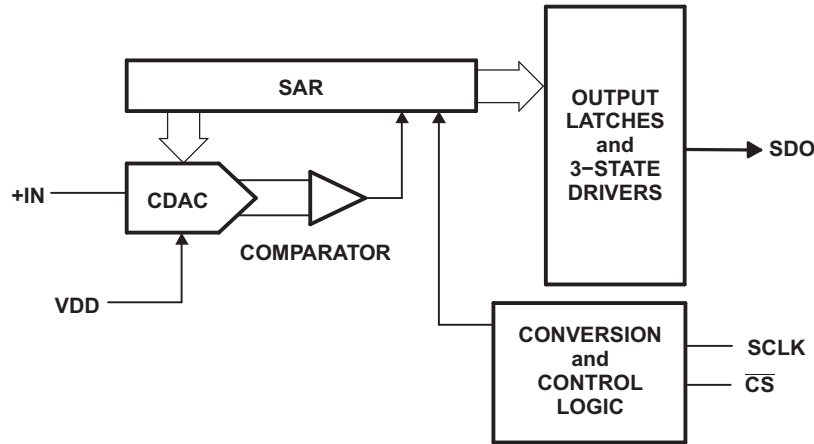

**PACKAGE/ORDERING INFORMATION<sup>(1)</sup>**

DEVICE	MAXIMUM INTEGRAL LINEARITY (LSB)	MAXIMUM DIFFERENTIAL LINEARITY (LSB)	NO MISSING CODES AT RESOLUTION (BIT)	PACKAGE TYPE	PACKAGE DESIGNATOR	TEMPERATURE RANGE	PACKAGE MARKING	ORDERING INFORMATION	TRANSPORT MEDIA QUANTITY
ADS7886SB	±1.25	±1	12	6-Pin SOT23	DBV	-40°C to 125°C	BBAQ	ADS7886SDBBVT	Tape and reel 250
								ADS7886SDBBVR	Tape and reel 3000
				6-Pin SC70	DCK		BNL	ADS7886SDCKT	Tape and reel 250
								ADS7886SDCKR	Tape and reel 3000
ADS7886S	±2	±2	11	6-Pin SOT23	DBV	-40°C to 125°C	BBAQ	ADS7886SDBVT	Tape and reel 250
								ADS7886SDBVR	Tape and reel 3000
				6-Pin SC70	DCK		BNL	ADS7886SDCKT	Tape and reel 250
								ADS7886SDCKR	Tape and reel 3000

(1) For most current package and ordering information, see the Package Option Addendum at the end of this document, or see the TI website at [www.ti.com](http://www.ti.com).

**ABSOLUTE MAXIMUM RATINGS<sup>(1)</sup>**

		UNIT
+IN to AGND		–0.3 V to +V <sub>DD</sub> +0.3 V
+V <sub>DD</sub> to AGND		–0.3 V to 7 V
Digital input voltage to GND		–0.3 V to (7 V)
Digital output to GND		–0.3 V to (+V <sub>DD</sub> + 0.3 V)
Operating temperature range		–40°C to 125°C
Storage temperature range		–65°C to 150°C
Junction temperature (T <sub>J</sub> Max)		150°C
Power dissipation, SOT23 and SC70 packages		(T <sub>J</sub> Max – T <sub>A</sub> )/θ <sub>JA</sub>
θ <sub>JA</sub> Thermal impedance	SOT23	295.2°C/W
	SC70	351.3°C/W
Lead temperature, soldering		215°C
		220°C

(1) Stresses above those listed under *absolute maximum ratings* may cause permanent damage to the device. Exposure to absolute maximum conditions for extended periods may affect device reliability.

**ELECTRICAL CHARACTERISTICS**

+V<sub>DD</sub> = 2.35 V to 5.25 V, T<sub>A</sub> = –40°C to 125°C, f<sub>(sample)</sub> = 1 MHz (unless otherwise noted)

PARAMETER		TEST CONDITIONS	MIN	TYP	MAX	UNIT
<b>ANALOG INPUT</b>						
Full-scale input voltage span <sup>(1)</sup>			0		V <sub>DD</sub>	V
Absolute input voltage range		+IN	–0.2		V <sub>DD</sub> +0.2	V
C <sub>I</sub>	Input capacitance <sup>(2)</sup>			21		pF
I <sub>IKG</sub>	Input leakage current	T <sub>A</sub> = 125°C		40		nA
<b>SYSTEM PERFORMANCE</b>						
Resolution				12		Bits
No missing codes		ADS7886SB	12			Bits
		ADS7886S	11			
INL	Integral nonlinearity	ADS7886SB	–1.25	±0.65	1.25	LSB <sup>(3)</sup>
		ADS7886S	2		2	
DNL	Differential nonlinearity	ADS7886SB	–1	+0.4/-0.65	1	LSB
		ADS7886S	–2		2	
E <sub>O</sub>	Offset error <sup>(4)</sup>	V <sub>DD</sub> = 2.35 V to 3.6 V	–2.5	±0.5	2.5	LSB
		V <sub>DD</sub> = 4.75 V to 5.25 V	–2	±0.5	2	
E <sub>G</sub>	Gain error		–1.75	±0.5	1.75	LSB
<b>SAMPLING DYNAMICS</b>						
Conversion time		20-MHz SCLK	760	800		ns
Acquisition time			325			ns
Maximum throughput rate		20-MHz SCLK			1	MHz
Aperture delay				5		ns
Step Response				160		ns
Overvoltage recovery				160		ns
<b>DYNAMIC CHARACTERISTICS</b>						
SNR	Signal-to-noise ratio	V <sub>DD</sub> = 2.35 V to 3.6 V, f <sub>I</sub> = 100 kHz	69	71.25		dB
		V <sub>DD</sub> = 4.75 V to 5.25 V, f <sub>I</sub> = 100 kHz	70	72.25		

(1) Ideal input span; does not include gain or offset error.

(2) See [Figure 28](#) for details on the sampling circuit.

(3) LSB means least significant bit.

(4) Measured relative to an ideal full-scale input.

**ELECTRICAL CHARACTERISTICS (continued)**

+V<sub>DD</sub> = 2.35 V to 5.25 V, T<sub>A</sub> = -40°C to 125°C, f<sub>(sample)</sub> = 1 MHz (unless otherwise noted)

PARAMETER		TEST CONDITIONS	MIN	TYP	MAX	UNIT
SINAD	Signal-to-noise and distortion	V <sub>DD</sub> = 2.35 V to 3.6 V, f <sub>I</sub> = 100 kHz	69	71.25		dB
		V <sub>DD</sub> = 4.75 V to 5.25 V, f <sub>I</sub> = 100 kHz	70	72.25		
THD	Total harmonic distortion <sup>(5)</sup>	f <sub>I</sub> = 100 kHz		-84		dB
SFDR	Spurious free dynamic range	f <sub>I</sub> = 100 kHz		85.5		dB
	Full power bandwidth	At -3 dB		15		MHz
<b>DIGITAL INPUT/OUTPUT</b>						
Logic family — CMOS						
V <sub>IH</sub>	High-level input voltage	V <sub>DD</sub> = 2.35 V to 3.6 V	1.8		5.25	V
		V <sub>DD</sub> = 3.6 V to 5.25 V	2.4		5.25	
V <sub>IL</sub>	Low-level input voltage	V <sub>DD</sub> = 5 V			0.8	V
		V <sub>DD</sub> = 3 V			0.4	
V <sub>OH</sub>	High-level output voltage	I <sub>(source)</sub> = 200 μA	V <sub>DD</sub> -0.2			V
V <sub>OL</sub>	Low-level output voltage	I <sub>(sink)</sub> = 200 μA			0.4	
<b>POWER SUPPLY REQUIREMENTS</b>						
+V <sub>DD</sub>	Supply voltage		2.35	3.3	5.25	V
	Supply current (normal mode)	V <sub>DD</sub> = 2.35 V to 3.6 V, 1-MHz throughput		1.3	1.5	mA
		V <sub>DD</sub> = 4.75 V to 5.25 V, 1-MHz throughput		1.5	2	
		V <sub>DD</sub> = 2.35 V to 3.6 V, static state			1.1	
		V <sub>DD</sub> = 4.75 V to 5.25 V, static state			1.5	
	Power down state supply current	SCLK off			1	μA
		SCLK on (20 MHz)			200	
	Power dissipation at 1-MHz throughput	V <sub>DD</sub> = 3 V		3.9	4.5	mW
		V <sub>DD</sub> = 5 V		7.5	10	
	Power dissipation in static state	V <sub>DD</sub> = 3 V			3.3	mW
		V <sub>DD</sub> = 5 V			7.5	
	Power up time				0.1	μs
	Invalid conversions after power up or reset				1	

(5) Calculated on the first nine harmonics of the input frequency.

**TIMING REQUIREMENTS (see Figure 1 and Figure 2)**

 All specifications typical at  $T_A = -40^\circ\text{C}$  to  $125^\circ\text{C}$ ,  $V_{DD} = 2.35\text{ V}$  to  $5.25\text{ V}$  (unless otherwise specified).

PARAMETER		TEST CONDITIONS <sup>(1)</sup>	MIN	TYP	MAX	UNIT
$t_{\text{conv}}$	Conversion time	ADS7886	$V_{DD} = 3\text{ V}$		$16 \times t_{\text{SCLK}}$	ns
			$V_{DD} = 5\text{ V}$		$16 \times t_{\text{SCLK}}$	
$t_q$	Minimum quiet time needed from bus 3-state to start of next conversion	$V_{DD} = 3\text{ V}$	40			ns
		$V_{DD} = 5\text{ V}$	40			
$t_{d1}$	Delay time, $\overline{\text{CS}}$ low to first data (0) out	$V_{DD} = 3\text{ V}$		15	25	ns
		$V_{DD} = 5\text{ V}$		13	25	
$t_{\text{su}1}$	Setup time, $\overline{\text{CS}}$ low to SCLK low	$V_{DD} = 3\text{ V}$	10			ns
		$V_{DD} = 5\text{ V}$	10			
$t_{d2}$	Delay time, SCLK falling to SDO	$V_{DD} = 3\text{ V}$		15	25	ns
		$V_{DD} = 5\text{ V}$		13	25	
$t_{h1}$	Hold time, SCLK falling to data valid <sup>(2)</sup>	$V_{DD} < 3\text{ V}$	7			ns
		$V_{DD} > 5\text{ V}$	5.5			
$t_{d3}$	Delay time, 16th SCLK falling edge to SDO 3-state	$V_{DD} = 3\text{ V}$		10	25	ns
		$V_{DD} = 5\text{ V}$		8	20	
$t_{w1}$	Pulse duration, $\overline{\text{CS}}$	$V_{DD} = 3\text{ V}$	25	40		ns
		$V_{DD} = 5\text{ V}$	25	40		
$t_{d4}$	Delay time, $\overline{\text{CS}}$ high to SDO 3-state	$V_{DD} = 3\text{ V}$		17	30	ns
		$V_{DD} = 5\text{ V}$		15	25	
$t_{wH}$	Pulse duration, SCLK high	$V_{DD} = 3\text{ V}$	$0.4 \times t_{\text{SCLK}}$			ns
		$V_{DD} = 5\text{ V}$	$0.4 \times t_{\text{SCLK}}$			
$t_{wL}$	Pulse duration, SCLK low	$V_{DD} = 3\text{ V}$	$0.4 \times t_{\text{SCLK}}$			ns
		$V_{DD} = 5\text{ V}$	$0.4 \times t_{\text{SCLK}}$			
	Frequency, SCLK	$V_{DD} = 3\text{ V}$			20	MHz
		$V_{DD} = 5\text{ V}$			20	
$t_{d5}$	Delay time, second falling edge of clock and $\overline{\text{CS}}$ to enter in powerdown (use min spec not to accidentally enter in powerdown) <a href="#">Figure 2</a>	$V_{DD} = 3\text{ V}$	-2		5	ns
		$V_{DD} = 5\text{ V}$	-2		5	
$t_{d6}$	Delay time, $\overline{\text{CS}}$ and 10th falling edge of clock to enter in powerdown (use max spec not to accidentally enter in powerdown) <a href="#">Figure 2</a>	$V_{DD} = 3\text{ V}$	2		-5	ns
		$V_{DD} = 5\text{ V}$	2		-5	

(1) 3-V Specifications apply from 2.35 V to 3.6 V, and 5-V specifications apply from 4.75 V to 5.25 V.

(2) With 50-pf load.

**DEVICE INFORMATION**

**SOT23/SC70 PACKAGE  
(TOP VIEW)**

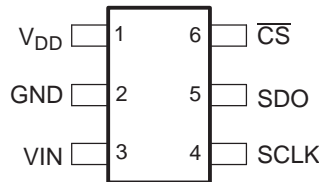

**TERMINAL FUNCTIONS**

TERMINAL		I/O	DESCRIPTION
NAME	NO.		
V <sub>DD</sub>	1	–	Power supply input also acts like a reference voltage to ADC.
GND	2	–	Ground for power supply, all analog and digital signals are referred with respect to this pin.
VIN	3	I	Analog signal input
SCLK	4	I	Serial clock
SDO	5	O	Serial data out
$\overline{\text{CS}}$	6	I	Chip select signal, active low

**NORMAL OPERATION**

The cycle begins with the falling edge of  $\overline{\text{CS}}$ . This point is indicated as **a** in Figure 1. With the falling edge of  $\overline{\text{CS}}$ , the input signal is sampled and the conversion process is initiated. The device outputs data while the conversion is in progress. The data word contains 4 leading zeros, followed by 12-bit data in MSB first format.

The falling edge of  $\overline{\text{CS}}$  clocks out the first zero, and a zero is clocked out on every falling edge of the clock until the third edge. Data is in MSB first format with the MSB being clocked out on the 4th falling edge. On the 16th falling edge of SCLK, SDO goes to the 3-state condition. The conversion ends on the 16th falling edge of SCLK. The device enters the acquisition phase on the first rising edge of SCLK after the 13th falling edge. This point is indicated by **b** in Figure 1.

$\overline{\text{CS}}$  can be asserted (pulled high) after 16 clocks have elapsed. It is necessary not to start the next conversion by pulling  $\overline{\text{CS}}$  low until the end of the quiet time ( $t_q$ ) after SDO goes to 3-state. To continue normal operation, it is necessary that  $\overline{\text{CS}}$  is not pulled high until point **b**. Without this, the device does not enter the acquisition phase and no valid data is available in the next cycle. (Also refer to power down mode for more details.)  $\overline{\text{CS}}$  going high any time after the conversion start aborts the ongoing conversion and SDO goes to 3-state.

The high level of the digital input to the device is not limited to device V<sub>DD</sub>. This means the digital input can go as high as 5.25 V when the device supply is 2.35 V. This feature is useful when digital signals are coming from another circuit with different supply levels. Also, this relaxes the restriction on power up sequencing. However, the digital output levels (V<sub>OH</sub> and V<sub>OL</sub>) are governed by V<sub>DD</sub> as listed in the *Electrical Characteristics* table.

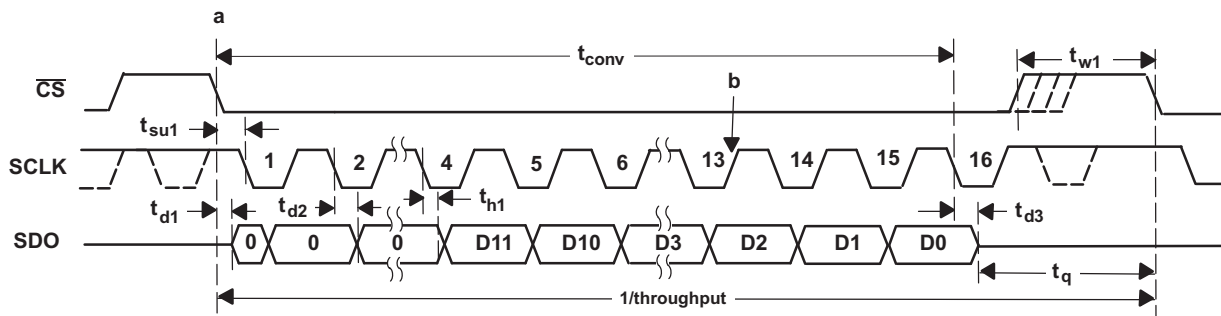

**Figure 1. Interface Timing Diagram**

### POWER DOWN MODE

The device enters power down mode if  $\overline{CS}$  goes high anytime after the 2nd SCLK falling edge to before the 10th SCLK falling edge. Ongoing conversion stops and SDO goes to 3-state under this power down condition as shown in Figure 2.

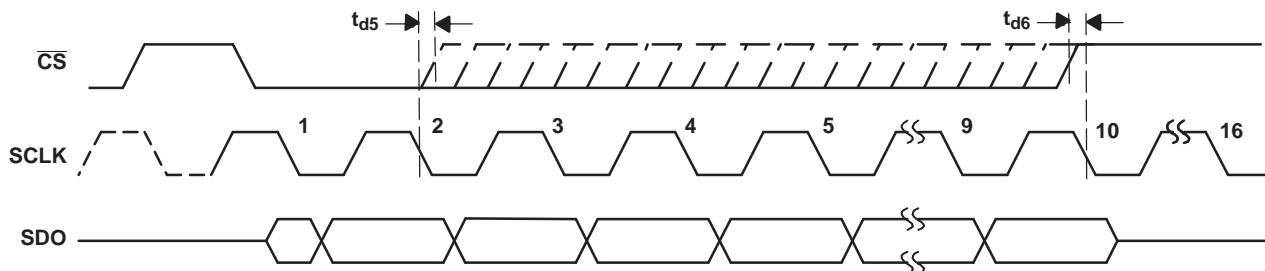

Figure 2. Entering Power Down Mode

A dummy cycle with  $\overline{CS}$  low for more than 10 SCLK falling edges brings the device out of power down mode. For the device to come to the fully powered up condition it takes 1  $\mu$ s.  $\overline{CS}$  can be pulled high any time after the 10th falling edge as shown in Figure 3. It is not necessary to continue until the 16th clock if the next conversion starts 1  $\mu$ s after  $\overline{CS}$  going low of the dummy cycle and the quiet time ( $t_q$ ) condition is met.

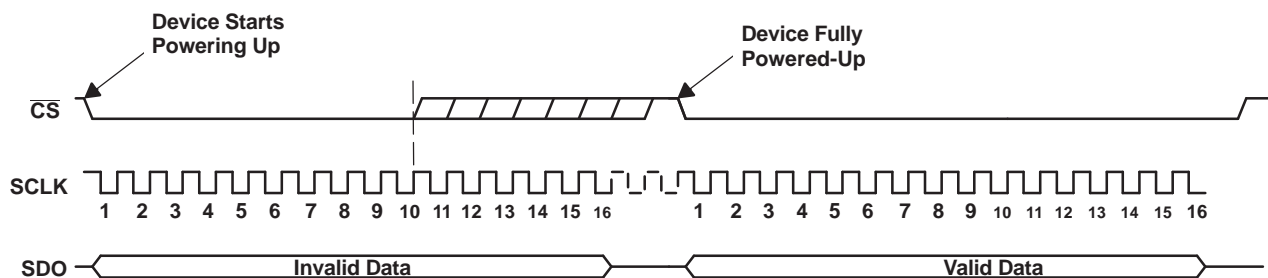

Figure 3. Exiting Power Down Mode

**TYPICAL CHARACTERISTICS**

**SUPPLY CURRENT  
vs  
SUPPLY VOLTAGE**

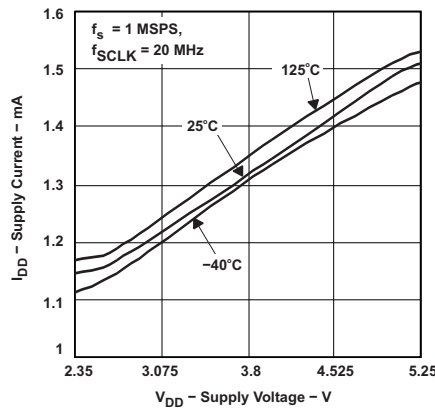

Figure 4.

**SUPPLY CURRENT  
vs  
SCLK FREQUENCY**

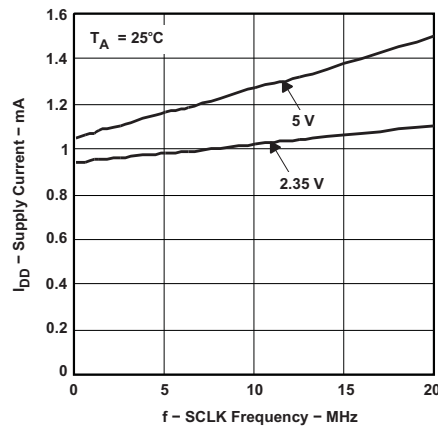

Figure 5.

**SUPPLY CURRENT  
vs  
SAMPLE RATE**

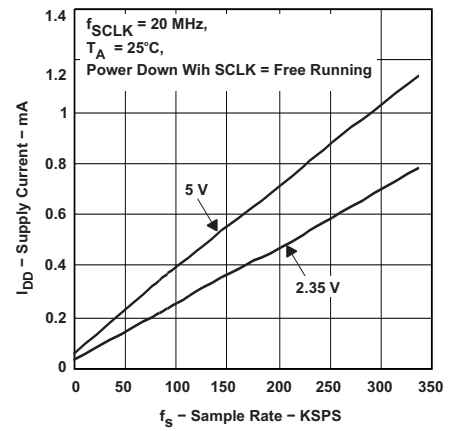

Figure 6.

**ANALOG INPUT  
LEAKAGE CURRENT  
vs  
FREE-AIR TEMPERATURE**

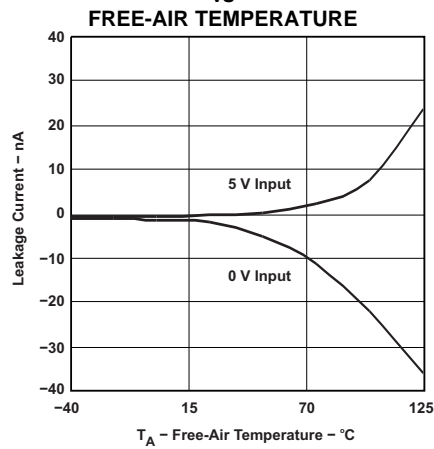

Figure 7.



TYPICAL CHARACTERISTICS

SIGNAL-TO-NOISE RATIO vs INPUT FREQUENCY

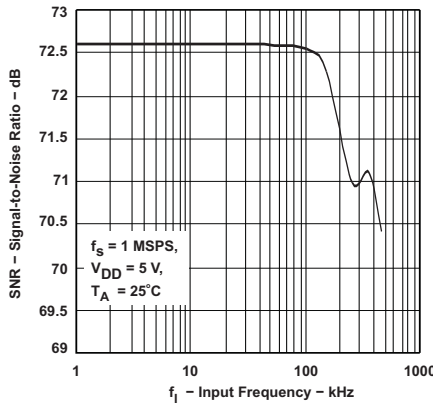

Figure 8.

SIGNAL-TO-NOISE RATIO vs SUPPLY VOLTAGE

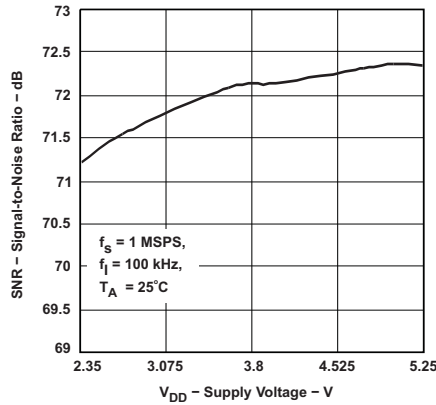

Figure 9.

SIGNAL-TO-NOISE RATIO vs FREE-AIR TEMPERATURE

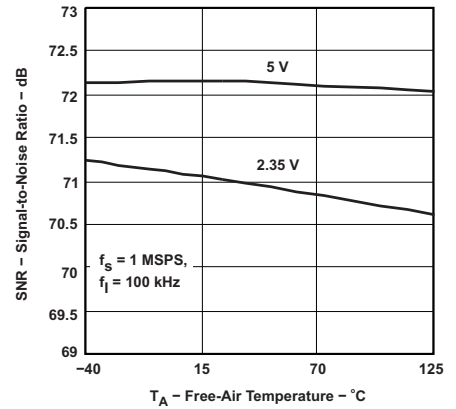

Figure 10.

TOTAL HARMONIC DISTORTION vs INPUT FREQUENCY

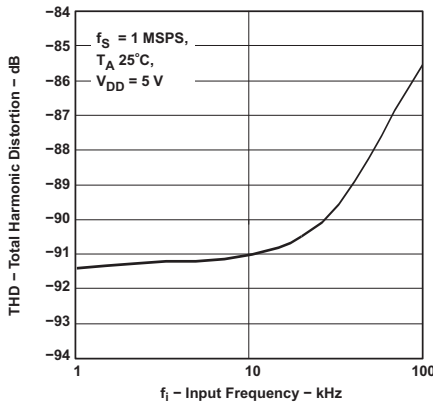

Figure 11.

TOTAL HARMONIC DISTORTION vs SUPPLY VOLTAGE

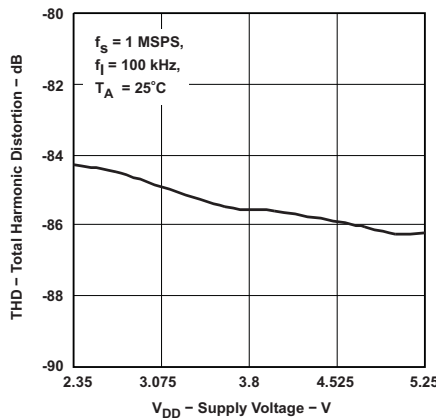

Figure 12.

TOTAL HARMONIC DISTORTION vs FREE-AIR TEMPERATURE

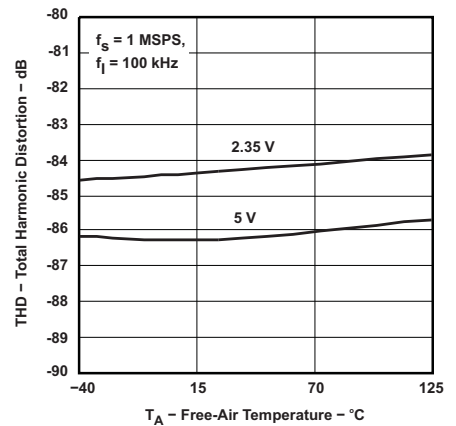

Figure 13.

SPURIOUS FREE DYNAMIC RANGE vs INPUT FREQUENCY

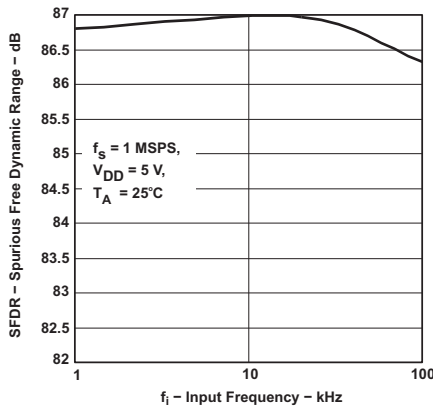

Figure 14.

SPURIOUS FREE DYNAMIC RANGE vs SUPPLY VOLTAGE

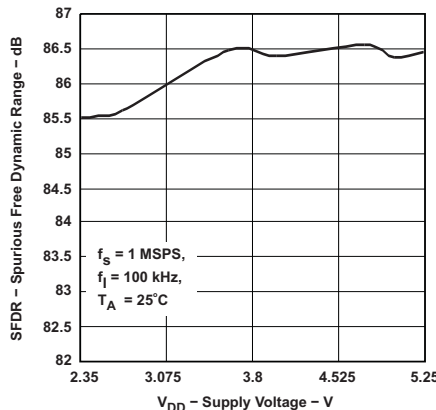

Figure 15.

SPURIOUS FREE DYNAMIC RANGE vs SUPPLY VOLTAGE

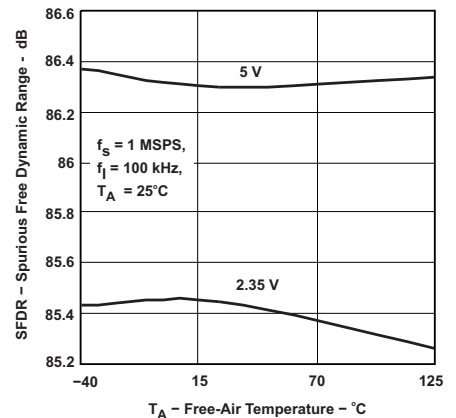

Figure 16.

TYPICAL CHARACTERISTICS (continued)

OFFSET ERROR  
VS  
SUPPLY VOLTAGE

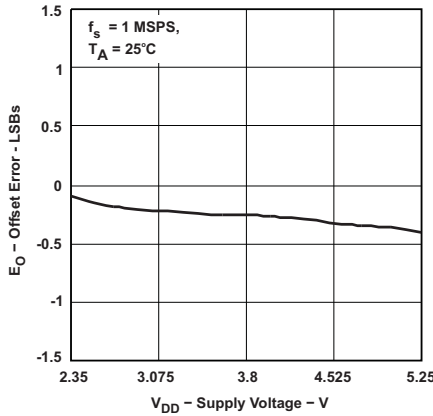

Figure 17.

OFFSET ERROR  
VS  
FREE-AIR TEMPERATURE

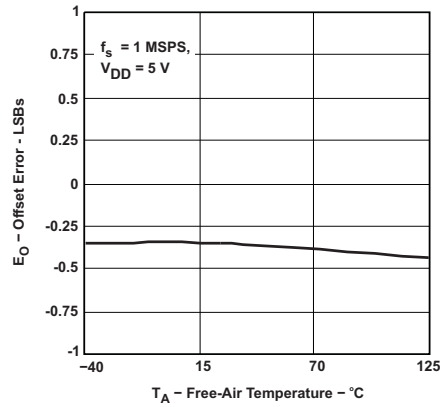

Figure 18.

GAIN ERROR  
VS  
SUPPLY VOLTAGE

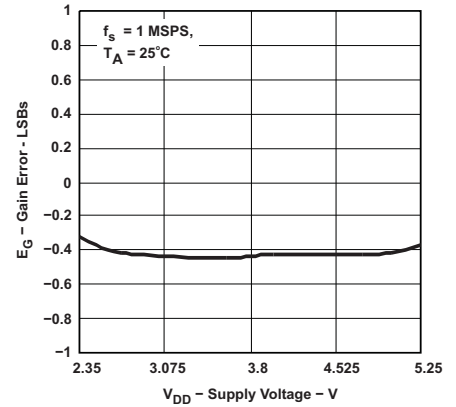

Figure 19.

GAIN ERROR  
VS  
FREE-AIR TEMPERATURE

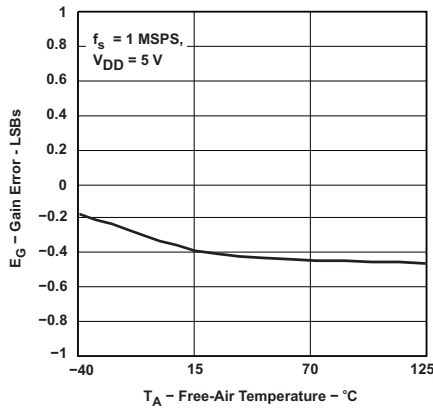

Figure 20.

DIFFERENTIAL LINEARITY ERROR  
VS  
SUPPLY VOLTAGE

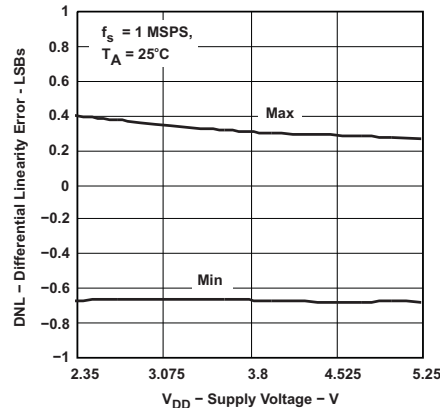

Figure 21.

DIFFERENTIAL NONLINEARITY  
VS  
FREE-AIR TEMPERATURE

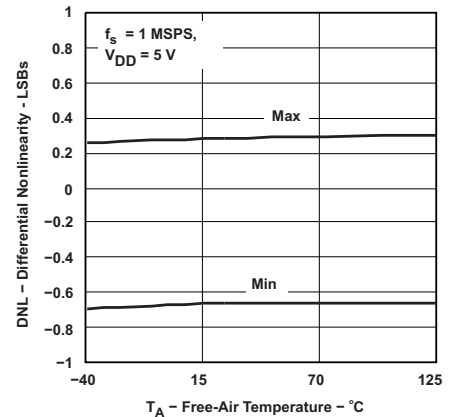

Figure 22.

INTEGRAL NONLINEARITY  
VS  
SUPPLY VOLTAGE

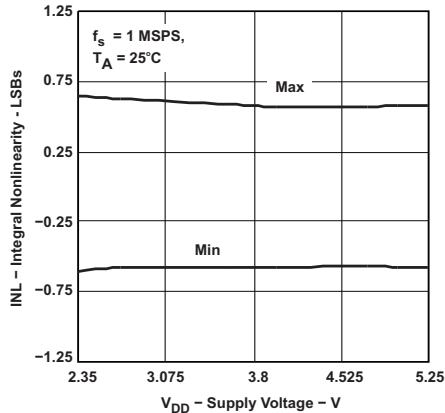

Figure 23.

INTEGRAL NONLINEARITY  
VS  
FREE-AIR TEMPERATURE

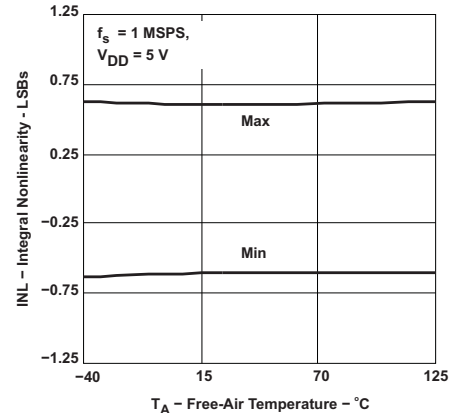
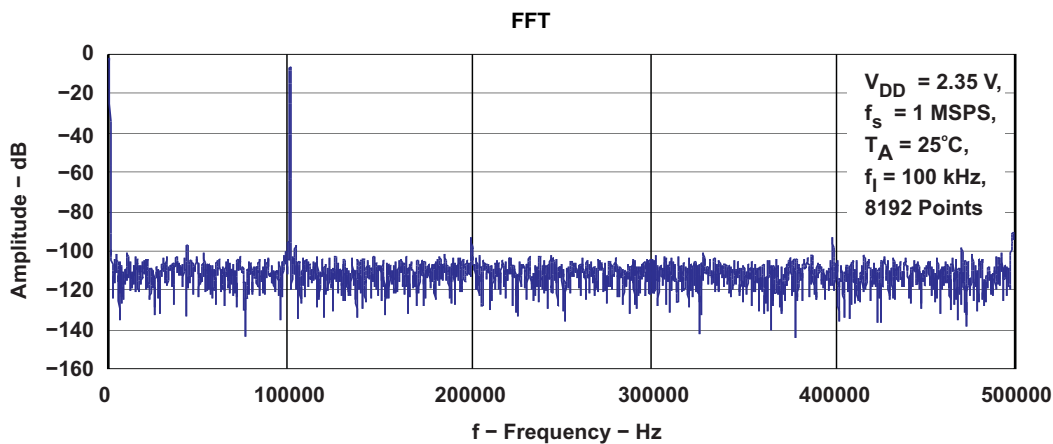
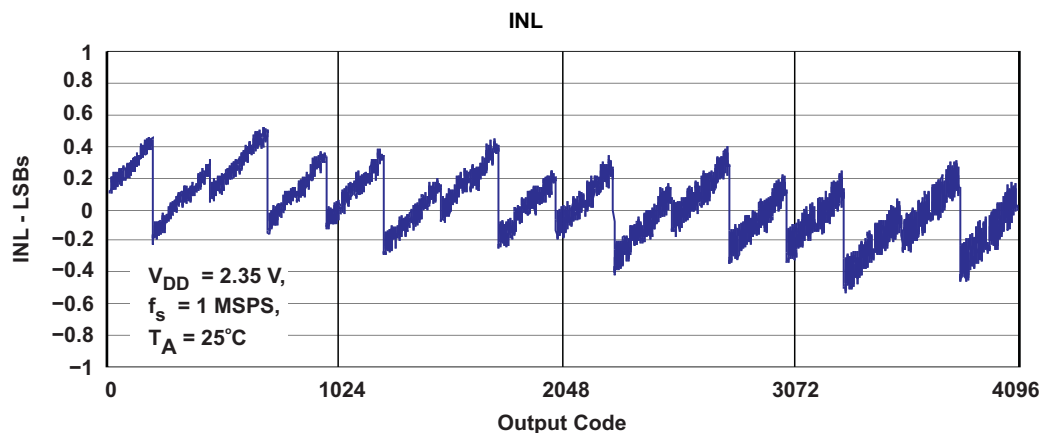
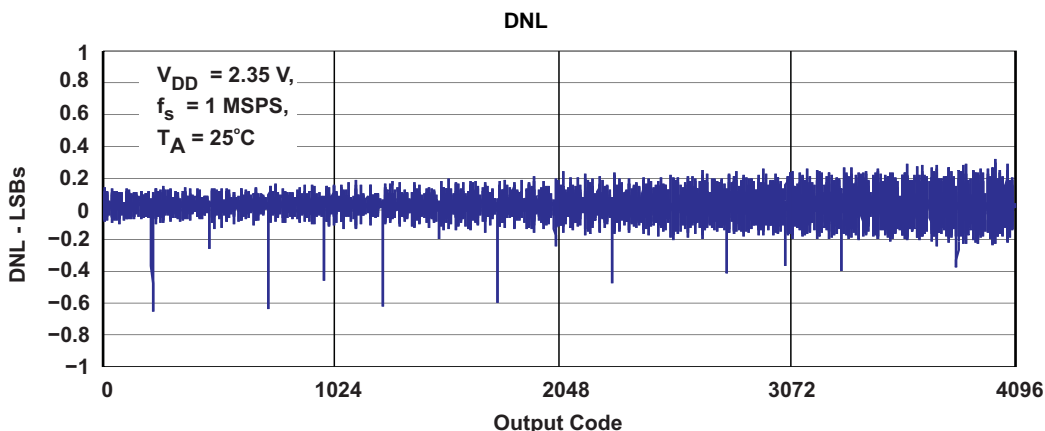

Figure 24.

TYPICAL CHARACTERISTICS (continued)



APPLICATION INFORMATION

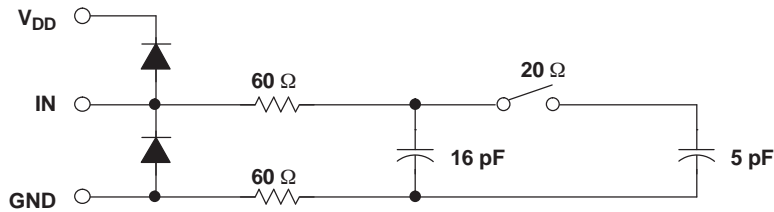

Figure 28. Typical Equivalent Sampling Circuit

Driving the VIN and VDD Pins

The VIN input should be driven with a low impedance source. In most cases additional buffers are not required. In cases where the source impedance exceeds 200 Ω, using a buffer would help achieve the rated performance of the converter. The THS4031 is a good choice for the driver amplifier buffer.

The reference voltage for the A/D converter is derived from the supply voltage internally. The devices offer limited low-pass filtering functionality on-chip. The supply to these converters should be driven with a low impedance source and should be decoupled to the ground. A 1-μF storage capacitor and a 10-nF decoupling capacitor should be placed close to the device. Wide, low impedance traces should be used to connect the capacitor to the pins of the device. The ADS7886 draws very little current from the supply lines. The supply line can be driven by either:

- Directly from the system supply.
- A reference output from a low drift and low drop out reference voltage generator like REF3030 or REF3130. The ADS7886 operates from a wide range of supply voltages. The actual choice of the reference voltage generator would depend upon the system. Figure 30 shows one possible application circuit.
- A low-pass filtered system supply followed by a buffer, like the zero-drift OPA735, can also be used in cases where the system power supply is noisy. Care should be taken to ensure that the voltage at the VDD input does not exceed 7 V to avoid damage to the converter. This can be done easily using single supply CMOS amplifiers like the OPA735. Figure 31 shows one possible application circuit.

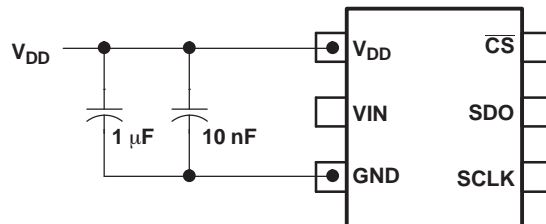

Figure 29. Supply/Reference Decoupling Capacitors

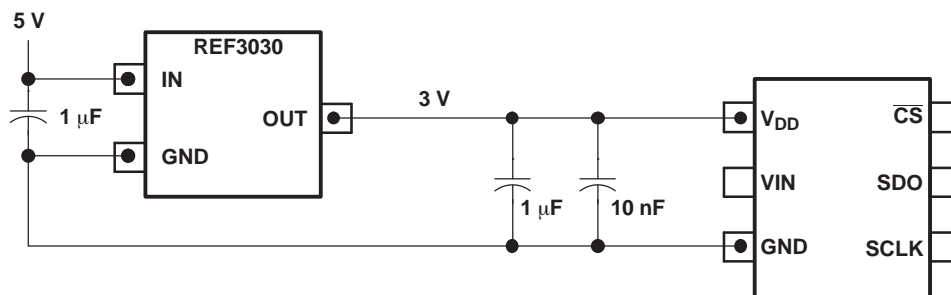

Figure 30. Using the REF3030 Reference

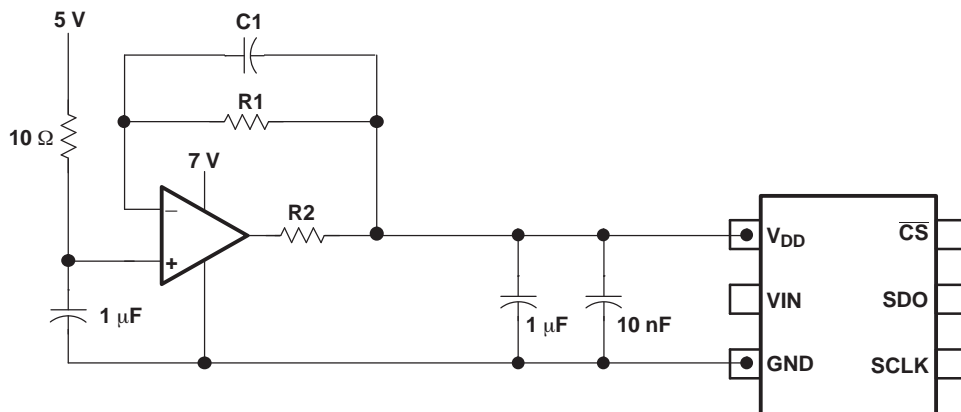

Figure 31. Buffering with the OPA735

## REVISION HISTORY

Changes from Original (SEPTEMBER 2005) to Revision A	Page
• Added $V_{IH}$ information .....	4
• Changed $V_{IH}$ information .....	4

**PACKAGING INFORMATION**

Orderable Device	Status (1)	Package Type	Package Drawing	Pins	Package Qty	Eco Plan (2)	Lead/Ball Finish	MSL Peak Temp (3)	Op Temp (°C)	Top-Side Markings (4)	Samples
ADS7886SBDBVR	ACTIVE	SOT-23	DBV	6	3000	Pb-Free (RoHS Exempt)	CU SN	Level-2-260C-1 YEAR	-40 to 125	BBAQ	<a href="#">Samples</a>
ADS7886SBDBVT	ACTIVE	SOT-23	DBV	6	250	Pb-Free (RoHS Exempt)	CU SN	Level-2-260C-1 YEAR	-40 to 125	BBAQ	<a href="#">Samples</a>
ADS7886SBDCKR	ACTIVE	SC70	DCK	6	3000	Pb-Free (RoHS Exempt)	CU SN	Level-2-260C-1 YEAR	-40 to 125	BNL	<a href="#">Samples</a>
ADS7886SBDCKT	ACTIVE	SC70	DCK	6	250	Pb-Free (RoHS Exempt)	CU SN	Level-2-260C-1 YEAR	-40 to 125	BNL	<a href="#">Samples</a>
ADS7886SDBVR	ACTIVE	SOT-23	DBV	6	3000	Pb-Free (RoHS Exempt)	CU SN	Level-2-260C-1 YEAR	-40 to 125	BBAQ	<a href="#">Samples</a>
ADS7886SDBVT	ACTIVE	SOT-23	DBV	6	250	Pb-Free (RoHS Exempt)	CU SN	Level-2-260C-1 YEAR	-40 to 125	BBAQ	<a href="#">Samples</a>
ADS7886SDCKR	ACTIVE	SC70	DCK	6	3000	Pb-Free (RoHS Exempt)	CU SN	Level-2-260C-1 YEAR	-40 to 125	BNL	<a href="#">Samples</a>
ADS7886SDCKT	ACTIVE	SC70	DCK	6	250	Pb-Free (RoHS Exempt)	CU SN	Level-2-260C-1 YEAR	-40 to 125	BNL	<a href="#">Samples</a>

(1) The marketing status values are defined as follows:

**ACTIVE:** Product device recommended for new designs.

**LIFEBUY:** TI has announced that the device will be discontinued, and a lifetime-buy period is in effect.

**NRND:** Not recommended for new designs. Device is in production to support existing customers, but TI does not recommend using this part in a new design.

**PREVIEW:** Device has been announced but is not in production. Samples may or may not be available.

**OBSELETE:** TI has discontinued the production of the device.

(2) Eco Plan - The planned eco-friendly classification: Pb-Free (RoHS), Pb-Free (RoHS Exempt), or Green (RoHS & no Sb/Br) - please check <http://www.ti.com/productcontent> for the latest availability information and additional product content details.

**TBD:** The Pb-Free/Green conversion plan has not been defined.

**Pb-Free (RoHS):** TI's terms "Lead-Free" or "Pb-Free" mean semiconductor products that are compatible with the current RoHS requirements for all 6 substances, including the requirement that lead not exceed 0.1% by weight in homogeneous materials. Where designed to be soldered at high temperatures, TI Pb-Free products are suitable for use in specified lead-free processes.

**Pb-Free (RoHS Exempt):** This component has a RoHS exemption for either 1) lead-based flip-chip solder bumps used between the die and package, or 2) lead-based die adhesive used between the die and leadframe. The component is otherwise considered Pb-Free (RoHS compatible) as defined above.

**Green (RoHS & no Sb/Br):** TI defines "Green" to mean Pb-Free (RoHS compatible), and free of Bromine (Br) and Antimony (Sb) based flame retardants (Br or Sb do not exceed 0.1% by weight in homogeneous material)

(3) MSL, Peak Temp. -- The Moisture Sensitivity Level rating according to the JEDEC industry standard classifications, and peak solder temperature.

<sup>(4)</sup> Multiple Top-Side Markings will be inside parentheses. Only one Top-Side Marking contained in parentheses and separated by a "~" will appear on a device. If a line is indented then it is a continuation of the previous line and the two combined represent the entire Top-Side Marking for that device.

**Important Information and Disclaimer:** The information provided on this page represents TI's knowledge and belief as of the date that it is provided. TI bases its knowledge and belief on information provided by third parties, and makes no representation or warranty as to the accuracy of such information. Efforts are underway to better integrate information from third parties. TI has taken and continues to take reasonable steps to provide representative and accurate information but may not have conducted destructive testing or chemical analysis on incoming materials and chemicals. TI and TI suppliers consider certain information to be proprietary, and thus CAS numbers and other limited information may not be available for release.

In no event shall TI's liability arising out of such information exceed the total purchase price of the TI part(s) at issue in this document sold by TI to Customer on an annual basis.



**TAPE AND REEL INFORMATION**

**QUADRANT ASSIGNMENTS FOR PIN 1 ORIENTATION IN TAPE**

\*All dimensions are nominal

Device	Package Type	Package Drawing	Pins	SPQ	Reel Diameter (mm)	Reel Width W1 (mm)	A0 (mm)	B0 (mm)	K0 (mm)	P1 (mm)	W (mm)	Pin1 Quadrant
ADS7886SDBVBR	SOT-23	DBV	6	3000	177.8	9.7	3.2	3.1	1.39	4.0	8.0	Q3
ADS7886SDBVBT	SOT-23	DBV	6	250	177.8	9.7	3.2	3.1	1.39	4.0	8.0	Q3
ADS7886SBDCKR	SC70	DCK	6	3000	177.8	9.7	2.3	2.52	1.2	4.0	8.0	Q3
ADS7886SBDCKT	SC70	DCK	6	250	177.8	9.7	2.3	2.52	1.2	4.0	8.0	Q3
ADS7886SDBVBR	SOT-23	DBV	6	3000	177.8	9.7	3.2	3.1	1.39	4.0	8.0	Q3
ADS7886SDBVBT	SOT-23	DBV	6	250	177.8	9.7	3.2	3.1	1.39	4.0	8.0	Q3
ADS7886SDCKR	SC70	DCK	6	3000	177.8	9.7	2.3	2.52	1.2	4.0	8.0	Q3
ADS7886SDCKT	SC70	DCK	6	250	177.8	9.7	2.3	2.52	1.2	4.0	8.0	Q3

**TAPE AND REEL BOX DIMENSIONS**

\*All dimensions are nominal

Device	Package Type	Package Drawing	Pins	SPQ	Length (mm)	Width (mm)	Height (mm)
ADS7886SBDBVR	SOT-23	DBV	6	3000	184.0	184.0	50.0
ADS7886SBDBVT	SOT-23	DBV	6	250	184.0	184.0	50.0
ADS7886SDCKR	SC70	DCK	6	3000	184.0	184.0	50.0
ADS7886SDCKT	SC70	DCK	6	250	184.0	184.0	50.0
ADS7886SDBVR	SOT-23	DBV	6	3000	184.0	184.0	50.0
ADS7886SDBVT	SOT-23	DBV	6	250	184.0	184.0	50.0
ADS7886SDCKR	SC70	DCK	6	3000	184.0	184.0	50.0
ADS7886SDCKT	SC70	DCK	6	250	184.0	184.0	50.0

DBV (R-PDSO-G6)

PLASTIC SMALL-OUTLINE PACKAGE



- NOTES:
- A. All linear dimensions are in millimeters.
  - B. This drawing is subject to change without notice.
  - C. Body dimensions do not include mold flash or protrusion. Mold flash and protrusion shall not exceed 0.15 per side.
  - D. Leads 1,2,3 may be wider than leads 4,5,6 for package orientation.
- $\triangle E$  Falls within JEDEC MO-178 Variation AB, except minimum lead width.

DBV (R-PDSO-G6)

PLASTIC SMALL OUTLINE



- NOTES:
- A. All linear dimensions are in millimeters.
  - B. This drawing is subject to change without notice.
  - C. Customers should place a note on the circuit board fabrication drawing not to alter the center solder mask defined pad.
  - D. Publication IPC-7351 is recommended for alternate designs.
  - E. Laser cutting apertures with trapezoidal walls and also rounding corners will offer better paste release. Customers should contact their board assembly site for stencil design recommendations. Example stencil design based on a 50% volumetric metal load solder paste. Refer to IPC-7525 for other stencil recommendations.

DCK (R-PDSO-G6)

PLASTIC SMALL-OUTLINE PACKAGE

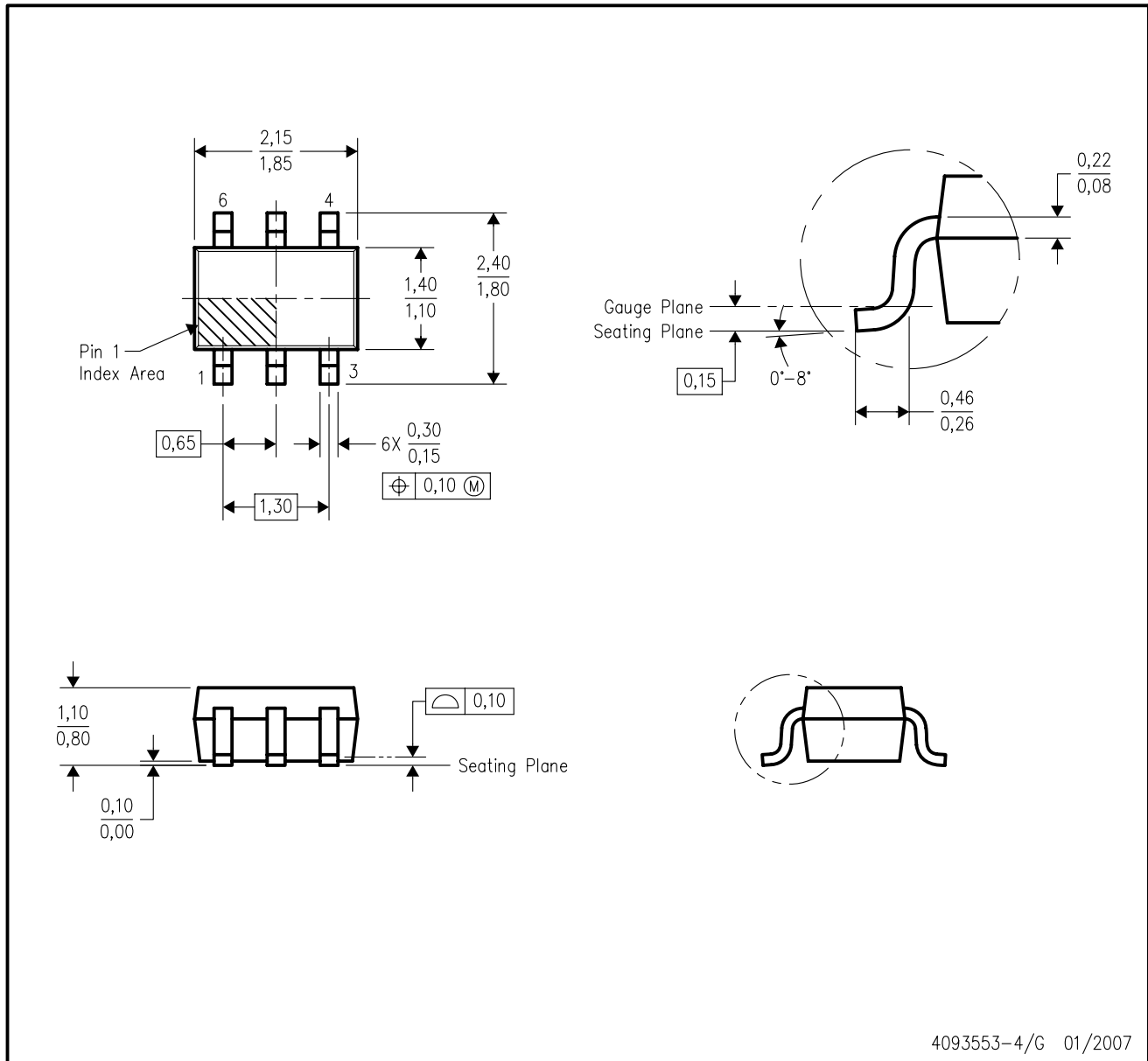

- NOTES:
- A. All linear dimensions are in millimeters.
  - B. This drawing is subject to change without notice.
  - C. Body dimensions do not include mold flash or protrusion. Mold flash and protrusion shall not exceed 0.15 per side.
  - D. Falls within JEDEC MO-203 variation AB.

DCK (R-PDSO-G6)

PLASTIC SMALL OUTLINE



- NOTES:
- A. All linear dimensions are in millimeters.
  - B. This drawing is subject to change without notice.
  - C. Customers should place a note on the circuit board fabrication drawing not to alter the center solder mask defined pad.
  - D. Publication IPC-7351 is recommended for alternate designs.
  - E. Laser cutting apertures with trapezoidal walls and also rounding corners will offer better paste release. Customers should contact their board assembly site for stencil design recommendations. Example stencil design based on a 50% volumetric metal load solder paste. Refer to IPC-7525 for other stencil recommendations.

## IMPORTANT NOTICE

Texas Instruments Incorporated and its subsidiaries (TI) reserve the right to make corrections, enhancements, improvements and other changes to its semiconductor products and services per JESD46, latest issue, and to discontinue any product or service per JESD48, latest issue. Buyers should obtain the latest relevant information before placing orders and should verify that such information is current and complete. All semiconductor products (also referred to herein as "components") are sold subject to TI's terms and conditions of sale supplied at the time of order acknowledgment.

TI warrants performance of its components to the specifications applicable at the time of sale, in accordance with the warranty in TI's terms and conditions of sale of semiconductor products. Testing and other quality control techniques are used to the extent TI deems necessary to support this warranty. Except where mandated by applicable law, testing of all parameters of each component is not necessarily performed.

TI assumes no liability for applications assistance or the design of Buyers' products. Buyers are responsible for their products and applications using TI components. To minimize the risks associated with Buyers' products and applications, Buyers should provide adequate design and operating safeguards.

TI does not warrant or represent that any license, either express or implied, is granted under any patent right, copyright, mask work right, or other intellectual property right relating to any combination, machine, or process in which TI components or services are used. Information published by TI regarding third-party products or services does not constitute a license to use such products or services or a warranty or endorsement thereof. Use of such information may require a license from a third party under the patents or other intellectual property of the third party, or a license from TI under the patents or other intellectual property of TI.

Reproduction of significant portions of TI information in TI data books or data sheets is permissible only if reproduction is without alteration and is accompanied by all associated warranties, conditions, limitations, and notices. TI is not responsible or liable for such altered documentation. Information of third parties may be subject to additional restrictions.

Resale of TI components or services with statements different from or beyond the parameters stated by TI for that component or service voids all express and any implied warranties for the associated TI component or service and is an unfair and deceptive business practice. TI is not responsible or liable for any such statements.

Buyer acknowledges and agrees that it is solely responsible for compliance with all legal, regulatory and safety-related requirements concerning its products, and any use of TI components in its applications, notwithstanding any applications-related information or support that may be provided by TI. Buyer represents and agrees that it has all the necessary expertise to create and implement safeguards which anticipate dangerous consequences of failures, monitor failures and their consequences, lessen the likelihood of failures that might cause harm and take appropriate remedial actions. Buyer will fully indemnify TI and its representatives against any damages arising out of the use of any TI components in safety-critical applications.

In some cases, TI components may be promoted specifically to facilitate safety-related applications. With such components, TI's goal is to help enable customers to design and create their own end-product solutions that meet applicable functional safety standards and requirements. Nonetheless, such components are subject to these terms.

No TI components are authorized for use in FDA Class III (or similar life-critical medical equipment) unless authorized officers of the parties have executed a special agreement specifically governing such use.

Only those TI components which TI has specifically designated as military grade or "enhanced plastic" are designed and intended for use in military/aerospace applications or environments. Buyer acknowledges and agrees that any military or aerospace use of TI components which have **not** been so designated is solely at the Buyer's risk, and that Buyer is solely responsible for compliance with all legal and regulatory requirements in connection with such use.

TI has specifically designated certain components as meeting ISO/TS16949 requirements, mainly for automotive use. In any case of use of non-designated products, TI will not be responsible for any failure to meet ISO/TS16949.

### Products

Audio	<a href="http://www.ti.com/audio">www.ti.com/audio</a>
Amplifiers	<a href="http://amplifier.ti.com">amplifier.ti.com</a>
Data Converters	<a href="http://dataconverter.ti.com">dataconverter.ti.com</a>
DLP® Products	<a href="http://www.dlp.com">www.dlp.com</a>
DSP	<a href="http://dsp.ti.com">dsp.ti.com</a>
Clocks and Timers	<a href="http://www.ti.com/clocks">www.ti.com/clocks</a>
Interface	<a href="http://interface.ti.com">interface.ti.com</a>
Logic	<a href="http://logic.ti.com">logic.ti.com</a>
Power Mgmt	<a href="http://power.ti.com">power.ti.com</a>
Microcontrollers	<a href="http://microcontroller.ti.com">microcontroller.ti.com</a>
RFID	<a href="http://www.ti-rfid.com">www.ti-rfid.com</a>
OMAP Applications Processors	<a href="http://www.ti.com/omap">www.ti.com/omap</a>
Wireless Connectivity	<a href="http://www.ti.com/wirelessconnectivity">www.ti.com/wirelessconnectivity</a>

### Applications

Automotive and Transportation	<a href="http://www.ti.com/automotive">www.ti.com/automotive</a>
Communications and Telecom	<a href="http://www.ti.com/communications">www.ti.com/communications</a>
Computers and Peripherals	<a href="http://www.ti.com/computers">www.ti.com/computers</a>
Consumer Electronics	<a href="http://www.ti.com/consumer-apps">www.ti.com/consumer-apps</a>
Energy and Lighting	<a href="http://www.ti.com/energy">www.ti.com/energy</a>
Industrial	<a href="http://www.ti.com/industrial">www.ti.com/industrial</a>
Medical	<a href="http://www.ti.com/medical">www.ti.com/medical</a>
Security	<a href="http://www.ti.com/security">www.ti.com/security</a>
Space, Avionics and Defense	<a href="http://www.ti.com/space-avionics-defense">www.ti.com/space-avionics-defense</a>
Video and Imaging	<a href="http://www.ti.com/video">www.ti.com/video</a>

### TI E2E Community

[e2e.ti.com](http://e2e.ti.com)