



10-/8-BIT, 3-MSPS, MICRO-POWER, MINIATURE SAR ANALOG-TO-DIGITAL CONVERTERS

FEATURES

- 3-MHz Sample Rate Serial Device
- 10-Bit Resolution – ADS7884
- 8-Bit Resolution – ADS7885
- Zero Latency
- 48-MHz Serial Interface
- Supply Range: 2.7 V to 5.5 V
- Low Power Dissipation:
 - 6.8 mW at 3-V V_{DD} , 2.5 MSPS
 - 15 mW at 5-V V_{DD} , 3 MSPS
- ± 0.3 LSB INL, ± 0.3 LSB DNL – ADS7884
- ± 0.15 LSB INL, ± 0.1 LSB DNL – ADS7885
- 61.7 dB SINAD, –81 dB THD – ADS7884
- 49.8 dB SINAD, –68 dB THD – ADS7885
- Unipolar Input Range: 0 V to V_{DD}
- Powerdown Current: 1 μ A
- Wide Input Bandwidth: 30 MHz at 3 dB
- 6-Pin SOT23 Package

APPLICATIONS

- Base Band Converters in Radio Communication
- Motor Current/Bus Voltage Sensors in Digital Drives
- Optical Networking (DWDM, MEMS Based Switching)
- Optical Sensors
- Battery Powered Systems
- Medical Instrumentations
- High-Speed Data Acquisition Systems
- High-Speed Closed-Loop Systems

DESCRIPTION

The ADS7884 is a 10-bit, 3-MSPS analog-to-digital converter (ADC), and the ADS7885 is a 8-bit, 3-MSPS ADC. The devices include a capacitor based SAR A/D converter with inherent sample and hold. The serial interface in each device is controlled by the \overline{CS} and SCLK signals for glueless connections with microprocessors and DSPs. The input signal is sampled with the falling edge of \overline{CS} , and SCLK is used for conversion and serial data output.

The devices operate from a wide supply range from 2.7 V to 5.5 V. The low power consumption of the devices make them suitable for battery-powered applications. The devices also include a power saving powerdown feature for when the devices are operated at lower conversion speeds.

The high level of the digital input to the device is not limited to device V_{DD} . This means the digital input can go as high as 5.5 V when device supply is 2.7 V. This feature is useful when digital signals are coming from other circuit with different supply levels. Also this relaxes restriction on power up sequencing.

The ADS7884 and ADS7885 are available in a 6-pin SOT23 package and are specified for operation from –40°C to 125°C.

Micro-Power Miniature SAR Converter Family

BIT	< 300 KSPS	300 KSPS – 1.25 MSPS	3 MSPS
12-Bit	ADS7866 (1.2 V_{DD} to 3.6 V_{DD})	ADS7886 (2.35 V_{DD} to 5.25 V_{DD})	—
10-Bit	ADS7867 (1.2 V_{DD} to 3.6 V_{DD})	ADS7887 (2.35 V_{DD} to 5.25 V_{DD})	ADS7884 (2.7 V_{DD} to 5.5 V_{DD})
8-Bit	ADS7868 (1.2 V_{DD} to 3.6 V_{DD})	ADS7888 (2.35 V_{DD} to 5.25 V_{DD})	ADS7885 (2.7 V_{DD} to 5.5 V_{DD})



Please be aware that an important notice concerning availability, standard warranty, and use in critical applications of Texas Instruments semiconductor products and disclaimers thereto appears at the end of this data sheet.



These devices have limited built-in ESD protection. The leads should be shorted together or the device placed in conductive foam during storage or handling to prevent electrostatic damage to the MOS gates.

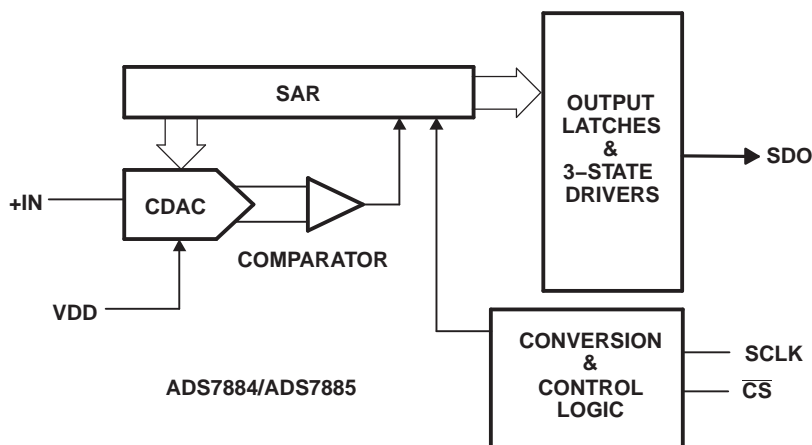

PACKAGE/ORDERING INFORMATION⁽¹⁾

DEVICE	MAXIMUM INTEGRAL LINEARITY (LSB)	MAXIMUM DIFFERENTIAL LINEARITY (LSB)	NO MISSING CODES AT RESOLUTION (BIT)	PACKAGE TYPE	PACKAGE DESIGNATOR	TEMPERATURE RANGE	PACKAGE MARKING	ORDERING INFORMATION	TRANSPORT MEDIA QUANTITY
ADS7884	±0.8	±0.8	10	6-Pin SOT23	DBV	–40°C to 125°C	7884	ADS7884SDBVT	Tape and reel 250
							7884	ADS7884SDBVR	Tape and reel 3000
ADS7885	±0.4	±0.4	8	6-Pin SOT23	DBV	–40°C to 125°C	7885	ADS7885SDBVT	Tape and reel 250
							7885	ADS7885SDBVR	Tape and reel 3000

(1) For most current package and ordering information, see the Package Option Addendum at the end of this document, or see the TI website at www.ti.com.

ABSOLUTE MAXIMUM RATINGS⁽¹⁾

	UNIT
+IN to AGND	–0.3 V to +V _{DD} +0.3 V
+V _{DD} to AGND	–0.3 V to 7.0 V
Digital input voltage to GND	–0.3V to (7.0 V)
Digital output to GND	–0.3 V to (+V _{DD} + 0.3 V)
Operating temperature range	–40°C to 125°C
Storage temperature range	–65°C to 150°C
Junction temperature (T _J Max)	150°C
Power dissipation, SOT23 package	(T _J Max–T _A)/θ _{JA}
Thermal impedance, θ _{JA}	SOT23
Lead temperature, soldering	Vapor phase (60 sec)
	Infrared (15 sec)

(1) Stresses above those listed under *absolute maximum ratings* may cause permanent damage to the device. Exposure to absolute maximum conditions for extended periods may affect device reliability.

ADS7884 SPECIFICATIONS

+V_{DD} = 2.7 V to 5.5 V, T_A = -40°C to 125°C, f_{sample} = 2.5 MSPS for V_{DD} = 2.7 V to 3.6 V, f_{sample} = 3 MSPS for V_{DD} = 3.6 V to 5.5 V

PARAMETER		TEST CONDITIONS	MIN	TYP	MAX	UNIT
ANALOG INPUT						
Full-scale input voltage span ⁽¹⁾			0		V _{DD}	V
Absolute input voltage range		+IN	-0.20		V _{DD} +0.20	V
C _i	Input capacitance ⁽²⁾			27		pF
I _{Ilkg}	Input leakage current	T _A = 125°C		40		nA
SYSTEM PERFORMANCE						
Resolution				10		Bits
No missing codes			10			Bits
INL	Integral nonlinearity		-0.8	±0.3	0.8	LSB ⁽³⁾
DNL	Differential nonlinearity		-0.8	±0.3	0.8	LSB
E _O	Offset error ⁽⁴⁾⁽⁵⁾⁽⁶⁾		-1	±0.2	1	LSB
E _G	Gain error ⁽⁵⁾		-1	±0.2	1	LSB
SAMPLING DYNAMICS						
Conversion time		48-MHz SCLK, V _{DD} = 5 V	224	240		ns
Acquisition time				93.3		ns
Maximum throughput rate		48-MHz SCLK, V _{DD} = 5 V			3	MHz
Aperture delay				10		ns
DYNAMIC CHARACTERISTICS						
THD	Total harmonic distortion ⁽⁷⁾	100 kHz		-81		dB
SINAD	Signal-to-noise and distortion	100 kHz	60	61.7		dB
SFDR	Spurious free dynamic range	100 kHz		81		dB
Full power bandwidth		At -3 dB	30			MHz
DIGITAL INPUT/OUTPUT						
Logic family — CMOS						
V _{IH}	High-level input voltage	V _{DD} = 2.7 V to 3.6 V	1.5		5.5	V
		V _{DD} = 3.6 V to 5.5 V	2.2		5.5	
V _{IL}	Low-level input voltage	V _{DD} = 5 V			0.8	V
		V _{DD} = 3 V			0.4	
V _{OH}	High-level output voltage	At I _{source} = 200 μA	V _{DD} -0.2			V
V _{OL}	Low-level output voltage	At I _{sink} = 200 μA			0.4	
POWER SUPPLY REQUIREMENTS						
+V _{DD}	Supply voltage		2.7	3.3	5.5	V
	Supply current (normal mode)	At V _{DD} = 3.0 V, 2.5-MSPS throughput		2.25	3	mA
		At V _{DD} = 3.0 V, static state		1.8		
		At V _{DD} = 5.0 V, 3-MSPS throughput		3	4	
		At V _{DD} = 5.0 V, static state		2		
	Power down state supply current	SCLK off			1	μA
		SCLK on (48 MHz)		90	200	
	Power dissipation	V _{DD} = 5 V, 3 MSPS		15	20	mW
		V _{DD} = 3 V, 2.5 MSPS		6.8		

- (1) Ideal input span; does not include gain or offset error.
- (2) Refer to [Figure 43](#) for details on sampling circuit
- (3) LSB means least significant bit
- (4) Measured relative to an ideal full-scale input
- (5) Offset error and gain error ensured by characterization.
- (6) First transition of 000H to 001H at (V_{ref}/2¹⁰)
- (7) Calculated on the first nine harmonics of the input frequency

ADS7884 SPECIFICATIONS (continued)

+V_{DD} = 2.7 V to 5.5 V, T_A = -40°C to 125°C, f_{sample} = 2.5 MSPS for V_{DD} = 2.7 V to 3.6 V, f_{sample} = 3 MSPS for V_{DD} = 3.6 V to 5.5 V

PARAMETER	TEST CONDITIONS	MIN	TYP	MAX	UNIT
Power dissipation in static state	V _{DD} = 5 V		10		mW
	V _{DD} = 3 V		5.4		
Powerdown time				0.1	μs
Powerup time				0.8	μs
TEMPERATURE RANGE					
Specified performance		-40		125	°C

ADS7885 SPECIFICATIONS

+V_{DD} = 2.7 V to 5.5 V, T_A = –40°C to 125°C, f_{sample} = 2.5 MSPS for V_{DD} = 2.7 V to 3.6 V, f_{sample} = 3 MSPS for V_{DD} = 3.6 V to 5.5 V

PARAMETER		TEST CONDITIONS	MIN	TYP	MAX	UNIT
ANALOG INPUT						
Full-scale input voltage span ⁽¹⁾			0		V _{DD}	V
Absolute input voltage range		+IN	–0.20		V _{DD} +0.20	V
C _i	Input capacitance ⁽²⁾			27		pF
I _{ilkq}	Input leakage current	T _A = 125°C		40		nA
SYSTEM PERFORMANCE						
Resolution				8		Bits
No missing codes			8			Bits
INL	Integral nonlinearity		–0.4	±0.15	0.4	LSB ⁽³⁾
DNL	Differential nonlinearity		–0.4	±0.1	0.4	LSB
E _O	Offset error ⁽⁴⁾⁽⁵⁾⁽⁶⁾		–0.4	±0.1	0.4	LSB
E _G	Gain error ⁽⁵⁾		–0.5	±0.1	0.5	LSB
SAMPLING DYNAMICS						
Conversion time		48-MHz SCLK, V _{DD} = 5 V	182	198		ns
Acquisition time		3 MSPS mode		135		ns
Maximum throughput rate		48-MHz SCLK, V _{DD} = 5 V			3	MHz
Aperture delay				10		ns
DYNAMIC CHARACTERISTICS						
THD	Total harmonic distortion ⁽⁷⁾	100 kHz		–68		dB
SINAD	Signal-to-noise and distortion	100 kHz	49	49.8		dB
SFDR	Spurious free dynamic range	100 kHz		74		dB
Full power bandwidth		At –3 dB	30			MHz
DIGITAL INPUT/OUTPUT						
Logic family — CMOS						
V _{IH}	High-level input voltage	V _{DD} = 2.7 V to 3.6 V	1.5		5.5	V
		V _{DD} = 3.6 V to 5.5 V	2.2		5.5	
V _{IL}	Low-level input voltage	V _{DD} = 5 V			0.8	V
		V _{DD} = 3 V			0.4	
V _{OH}	High-level output voltage	At I _{source} = 200 μA	V _{DD} –0.2			V
V _{OL}	Low-level output voltage	At I _{sink} = 200 μA			0.4	
POWER SUPPLY REQUIREMENTS						
+V _{DD}	Supply voltage		2.7	3.3	5.5	V
	Supply current (normal mode)	At V _{DD} = 3.0 V, 2.5-MSPS throughput		2.25	3	mA
		At V _{DD} = 3.0 V, static state		1.8		
		At V _{DD} = 5.0 V, 3-MSPS throughput		3	4	
		At V _{DD} = 5.0 V, static state		2		
	Power down state supply current	SCLK off			1	μA
		SCLK on (48 MHz)		90	200	
	Power dissipation	V _{DD} = 5 V, 3 MSPS		15	20	mW
		V _{DD} = 3 V, 2.5 MSPS		6.8		

- (1) Ideal input span; does not include gain or offset error.
- (2) Refer to [Figure 43](#) for details on sampling circuit
- (3) LSB means least significant bit
- (4) Measured relative to an ideal full-scale input
- (5) Offset error and gain error ensured by characterization.
- (6) First transition of 000H to 001H at (V_{ref}/2⁸)
- (7) Calculated on the first nine harmonics of the input frequency

ADS7885 SPECIFICATIONS (continued)

+ $V_{DD} = 2.7\text{ V to }5.5\text{ V}$, $T_A = -40^\circ\text{C to }125^\circ\text{C}$, $f_{\text{sample}} = 2.5\text{ MSPS}$ for $V_{DD} = 2.7\text{ V to }3.6\text{ V}$, $f_{\text{sample}} = 3\text{ MSPS}$ for $V_{DD} = 3.6\text{ V to }5.5\text{ V}$

PARAMETER	TEST CONDITIONS	MIN	TYP	MAX	UNIT
Power dissipation in static state	$V_{DD} = 5\text{ V}$		10		mW
	$V_{DD} = 3\text{ V}$		5.4		
Powerdown time				0.1	μs
Powerup time				0.8	μs
TEMPERATURE RANGE					
Specified performance		-40		125	$^\circ\text{C}$

TIMING REQUIREMENTS (see Figure 1)

All specifications typical at $T_A = -40^\circ\text{C to }125^\circ\text{C}$, $V_{DD} = 2.7\text{ V to }5.5\text{ V}$, unless otherwise specified.

PARAMETER	TEST CONDITIONS ⁽¹⁾	MIN	TYP	MAX	UNIT
t_{conv} Conversion time	ADS7884	$V_{DD} = 3\text{ V}$		$11.5 \times t_{\text{SCLK}}$	ns
		$V_{DD} = 5\text{ V}$		$11.5 \times t_{\text{SCLK}}$	
	ADS7885	$V_{DD} = 3\text{ V}$		$9.5 \times t_{\text{SCLK}}$	
		$V_{DD} = 5\text{ V}$		$9.5 \times t_{\text{SCLK}}$	
t_{acq} Acquisition time	$V_{DD} = 3\text{ V}$	62.5			ns
	$V_{DD} = 5\text{ V}$	52			
t_q Minimum quiet time needed from bus 3-state to start of next conversion	$V_{DD} = 3\text{ V}$	10			ns
	$V_{DD} = 5\text{ V}$	10			
t_{d1} Delay time, $\overline{\text{CS}}$ low to first data (0) out	$V_{DD} = 3\text{ V}$		9	15	ns
	$V_{DD} = 5\text{ V}$		8	11	
$t_{\text{su}1}$ Setup time, $\overline{\text{CS}}$ low to SCLK low	$V_{DD} = 3\text{ V}$	7			ns
	$V_{DD} = 5\text{ V}$	5			
t_{d2} Delay time, SCLK falling to SDO	$V_{DD} = 3\text{ V}$		11	20	ns
	$V_{DD} = 5\text{ V}$		9	12	
t_{h1} Hold time, SCLK falling to data valid ⁽²⁾	$V_{DD} < 3\text{ V}$	5.5			ns
	$V_{DD} > 5\text{ V}$	4			
t_{d3} Delay time, 16th SCLK falling edge to SDO 3-state	$V_{DD} = 3\text{ V}$		9	15	ns
	$V_{DD} = 5\text{ V}$		8	11	
t_{w1} Pulse duration, $\overline{\text{CS}}$	$V_{DD} = 3\text{ V}$	10			ns
	$V_{DD} = 5\text{ V}$	10			
t_{d4} Delay time, $\overline{\text{CS}}$ high to SDO 3-state,	$V_{DD} = 3\text{ V}$		9	15	ns
	$V_{DD} = 5\text{ V}$		8	11	
t_{wH} Pulse duration, SCLK high	$V_{DD} = 3\text{ V}$	$0.45 \times t_{\text{SCLK}}$			ns
	$V_{DD} = 5\text{ V}$	$0.45 \times t_{\text{SCLK}}$			
t_{wL} Pulse duration, SCLK low	$V_{DD} = 3\text{ V}$	$0.45 \times t_{\text{SCLK}}$			ns
	$V_{DD} = 5\text{ V}$	$0.45 \times t_{\text{SCLK}}$			
Frequency, SCLK	$V_{DD} = 3\text{ V}$			40	MHz
	$V_{DD} = 5\text{ V}$			48	
t_{d5} Delay time, second falling edge of clock and $\overline{\text{CS}}$ to enter in powerdown (use min spec not to accidentally enter in powerdown) Figure 3	$V_{DD} = 3\text{ V}$	-2		4	ns
	$V_{DD} = 5\text{ V}$	-2		3	

(1) 3-V Specifications apply from 2.7 V to 3.6 V, and 5-V specifications apply from 4.5 V to 5.5 V.

(2) With 10-pf load.

TIMING REQUIREMENTS (see Figure 1) (continued)

All specifications typical at $T_A = -40^\circ\text{C}$ to 125°C , $V_{DD} = 2.7\text{ V}$ to 5.5 V , unless otherwise specified.

PARAMETER	TEST CONDITIONS ⁽¹⁾	MIN	TYP	MAX	UNIT
t_{d6} Delay time, $\overline{\text{CS}}$ and 10th falling edge of clock to enter in powerdown (use max spec not to accidentally enter in powerdown) Figure 3	$V_{DD} = 3\text{ V}$	-2		4	ns
	$V_{DD} = 5\text{ V}$	-2		3	

DEVICE INFORMATION

SOT23 PACKAGE (TOP VIEW)

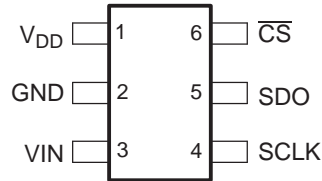

TERMINAL FUNCTIONS

TERMINAL	I/O	DESCRIPTION
NAME NO.		
V_{DD} 1	–	Power supply input also acts like a reference voltage to ADC.
GND 2	–	Ground for power supply, all analog and digital signals are referred with respect to this pin.
VIN 3	I	Analog signal input
SCLK 4	I	Serial clock
SDO 5	O	Serial data out
$\overline{\text{CS}}$ 6	I	Chip select signal, active low

ADS7884 NORMAL OPERATION

The cycle begins with the falling edge of $\overline{\text{CS}}$. This point is indicated as **a** in Figure 1. With the falling edge of $\overline{\text{CS}}$, the input signal is sampled and the conversion process is initiated. The device outputs data while the conversion is in progress. The data word contains 2 leading zeros, followed by 10-bit data in MSB first format and padded by 4 lagging zeros.

The falling edge of $\overline{\text{CS}}$ clocks out the first zero, and a second zero is clocked out on FIRST falling edge of the clock. Data is in MSB first format with the MSB being clocked out on the 2nd falling edge. Data is padded with four lagging zeros as shown in Figure 1. The conversion ends on the first rising edge of SCLK after the 11th falling edge. At this point the device enters the acquisition phase. This point is indicated by **b** in Figure 1.

Figure 1 shows device data is read in a sixteen clock frame. However, $\overline{\text{CS}}$ can be asserted (pulled high) any time after 11 clocks have elapsed. SDO goes to 3-state with the $\overline{\text{CS}}$ high level. The next conversion should not be started (by pulling $\overline{\text{CS}}$ low) until the end of the quiet sampling time (t_q) after SDO goes to 3-state or until the minimum acquisition time (t_{acq}) has elapsed. To continue normal operation, it is necessary that $\overline{\text{CS}}$ is not pulled high until point **b**. Without this, the device does not enter the acquisition phase and no valid data is available in the next cycle. (Also refer to the Powerdown Mode section for more details.) $\overline{\text{CS}}$ going high any time after the conversion start aborts the ongoing conversion and SDO goes to 3-state.

The high level of the digital input to the device is not limited to device V_{DD} . This means the digital input can go as high as 5.5 V when the device supply is 2.7 V. This feature is useful when digital signals are coming from another circuit with different supply levels. Also, this relaxes the restriction on powerup sequencing. However, the digital output levels (V_{OH} and V_{OL}) are governed by V_{DD} as listed in the Specifications table.

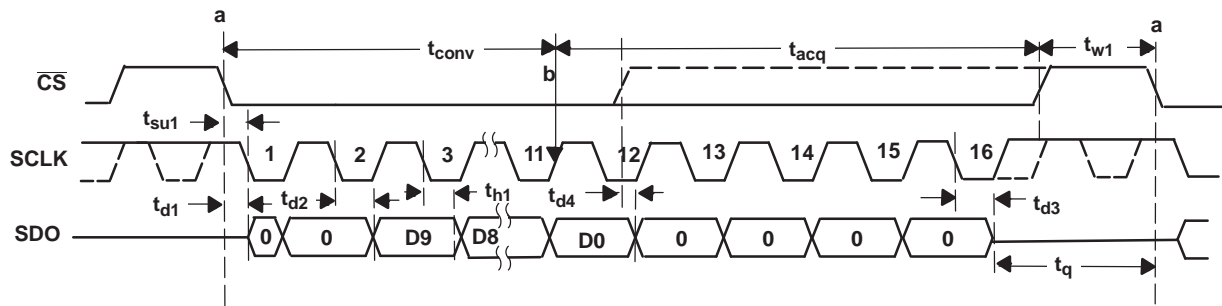

Figure 1. ADS7884 Interface Timing Diagram

ADS7885 NORMAL OPERATION

The cycle begins with the falling edge of \overline{CS} . This point is indicated as **a** in Figure 2. With the falling edge of \overline{CS} , the input signal is sampled and the conversion process is initiated. The device outputs data while the conversion is in progress. The data word contains 2 leading zeros, followed by 8-bit data in MSB first format and padded by 6 lagging zeros.

The falling edge of \overline{CS} clocks out the first zero, and a second zero is clocked out on FIRST falling edge of the clock. Data is in MSB first format with the MSB being clocked out on the 3rd falling edge. Data is padded with six lagging zeros as shown in Figure 2. On the 16th falling edge of SCLK, SDO goes to the 3-state condition. The conversion ends on the first rising edge of SCLK after the 9th falling edge. At this point the device enters the acquisition phase. This point is indicated by **b** in Figure 2.

Figure 2 shows device data is read in a sixteen clock frame. However, \overline{CS} can be asserted (pulled high) any time after 9 clocks have elapsed (after the 10th falling edge of SCLK). SDO goes to 3-state with the \overline{CS} high level. The next conversion should not be started (by pulling \overline{CS} low) until the end of the quiet sampling time (t_q) after SDO goes to 3-state or until the minimum acquisition time (t_{acq}) has elapsed. To continue normal operation, it is necessary that \overline{CS} is not pulled high until point **b**. Without this, the device does not enter the acquisition phase and no valid data is available in the next cycle. (Also refer to the Powerdown Mode section for more details.) \overline{CS} going high any time after the conversion start aborts the ongoing conversion and SDO goes to 3-state.

The high level of the digital input to the device is not limited to device V_{DD} . This means the digital input can go as high as 5.5 V when the device supply is 2.7 V. This feature is useful when digital signals are coming from another circuit with different supply levels. Also, this relaxes the restriction on powerup sequencing. However, the digital output levels (V_{OH} and V_{OL}) are governed by V_{DD} as listed in the Specifications section.

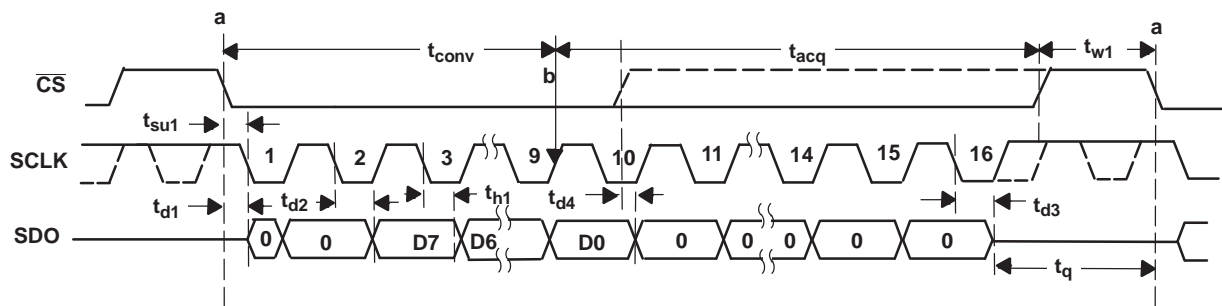

Figure 2. ADS7885 Interface Timing Diagram

POWER DOWN MODE

The device enters powerdown mode if \overline{CS} goes high anytime after the 2nd SCLK falling edge to before the 10th SCLK falling edge. Ongoing conversion stops and SDO goes to 3-state under this powerdown condition as shown in Figure 3.

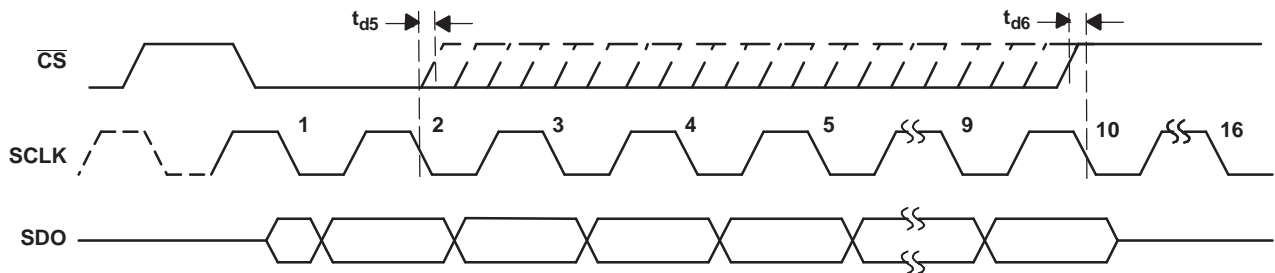

Figure 3. Entering Power Down Mode

A dummy cycle with \overline{CS} low for more than 10 SCLK falling edges brings the device out of powerdown mode. For the device to come to the fully powered up condition it takes 0.8 μs . \overline{CS} can be pulled high any time after the 10th falling edge as shown in Figure 4. Note that the powerup time of 0.8 μsec is more than a single conversion cycle at 3 MSPS speed. This means the device requires three dummy conversion frames at 3 MSPS speed or one elongated dummy conversion frame. The data during dummy conversion frames is invalid.

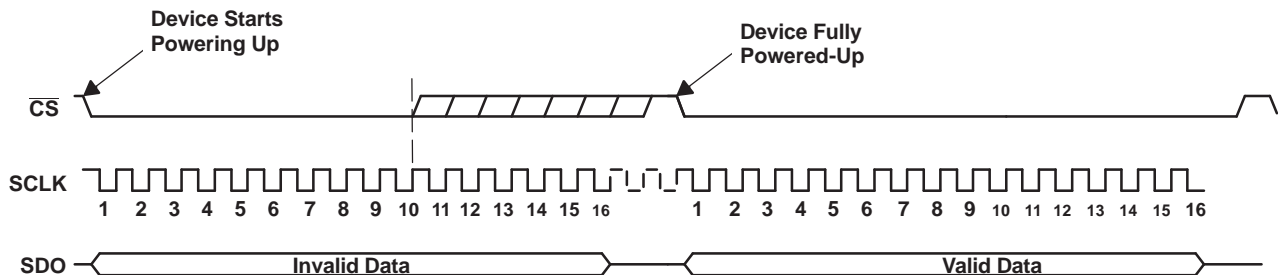

Figure 4. Exiting Power Down Mode

TYPICAL CHARACTERISTICS ADS7884

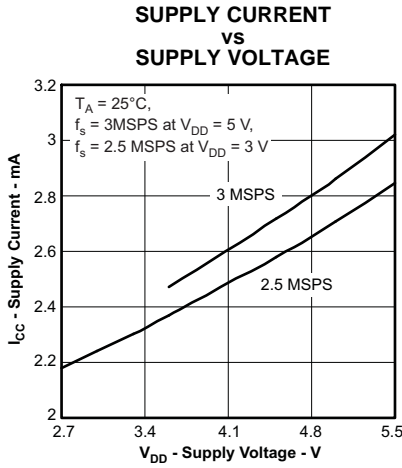

Figure 5.

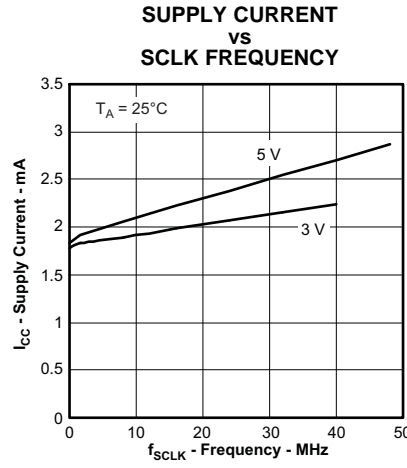

Figure 6.

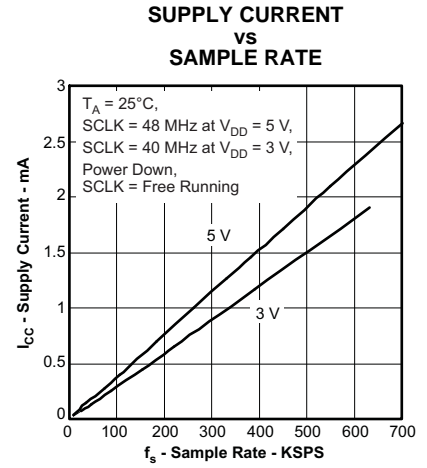

Figure 7.

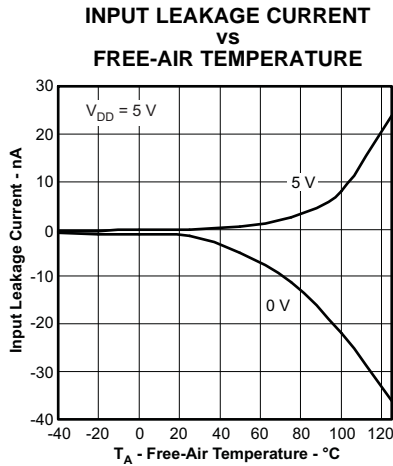

Figure 8.

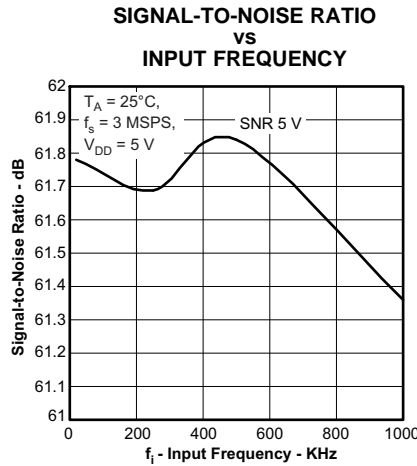

Figure 9.

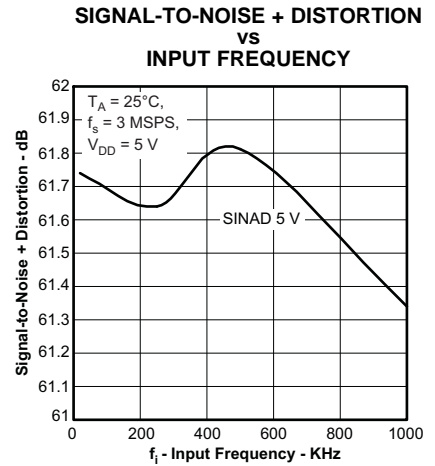

Figure 10.

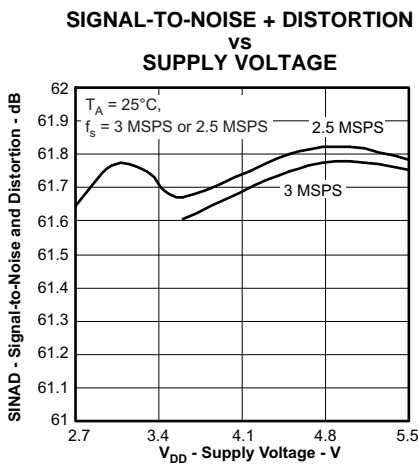

Figure 11.

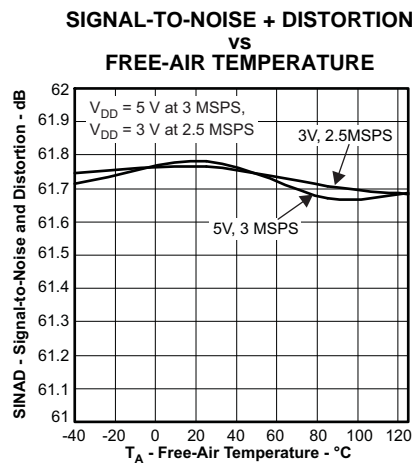

Figure 12.

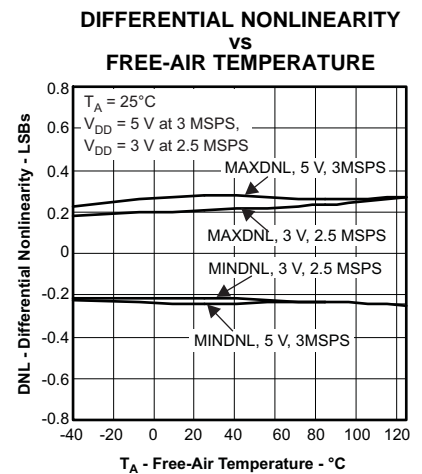

Figure 13.

TYPICAL CHARACTERISTICS ADS7884 (continued)

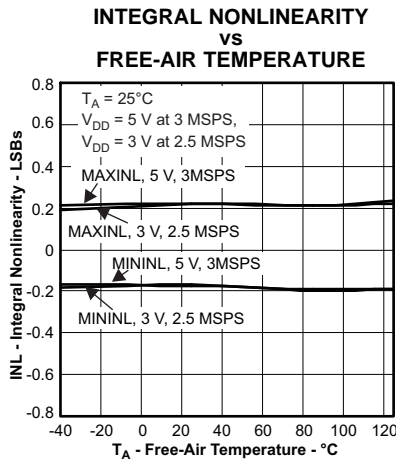

Figure 14.

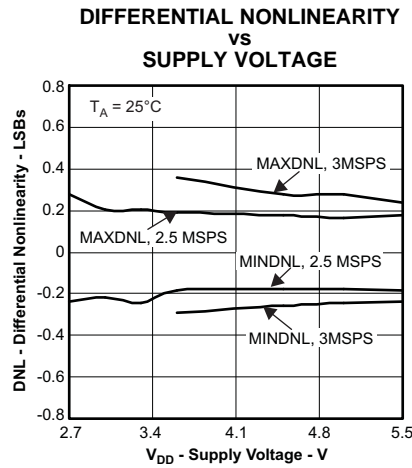

Figure 15.

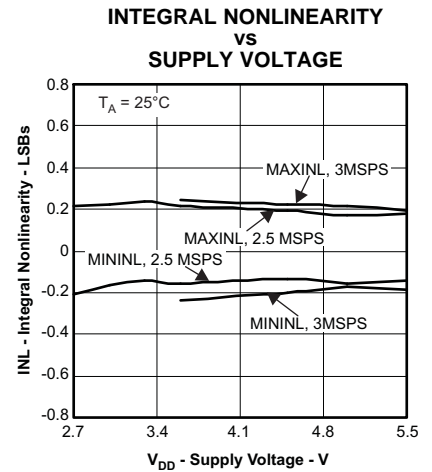

Figure 16.

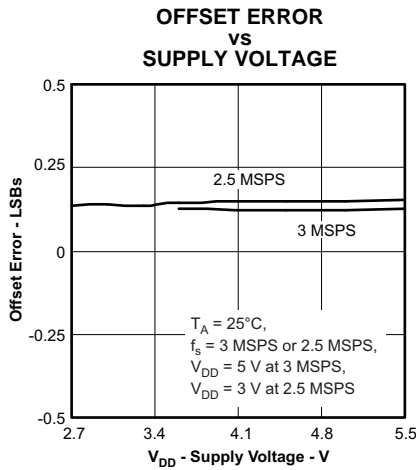

Figure 17.

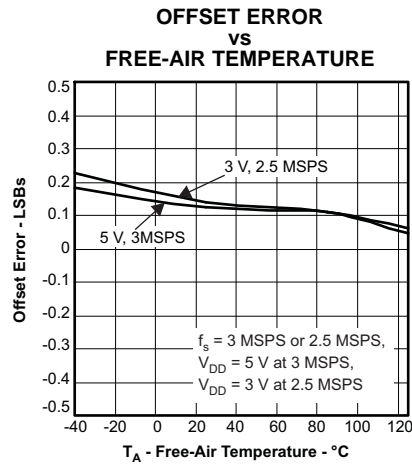

Figure 18.

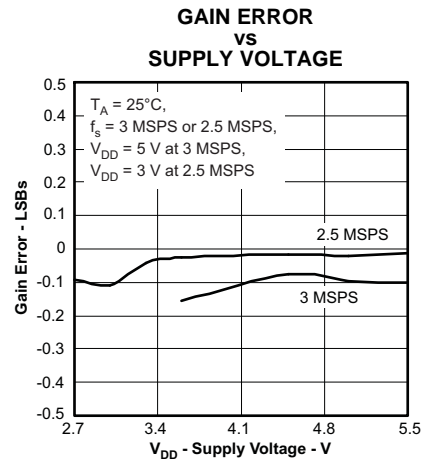

Figure 19.

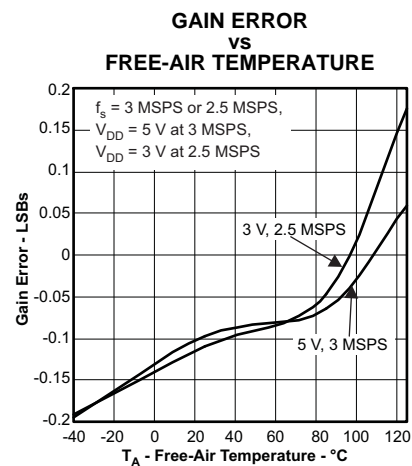

Figure 20.

TYPICAL CHARACTERISTICS ADS7884 (continued)

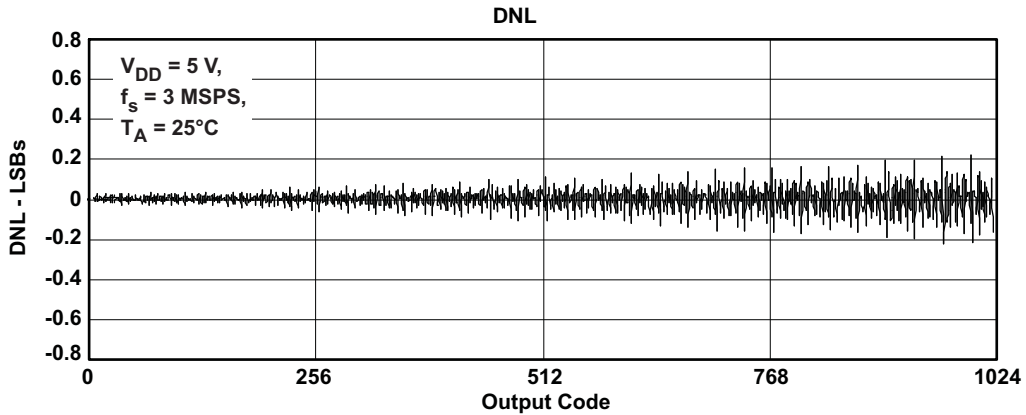

Figure 21.

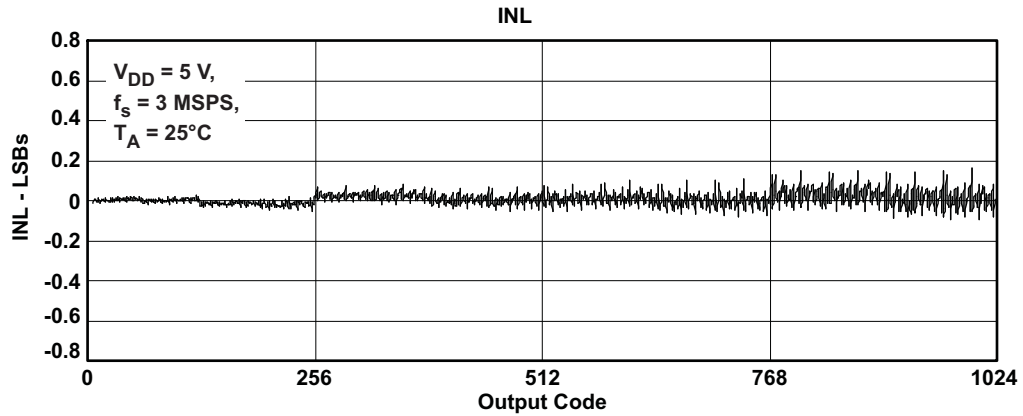

Figure 22.

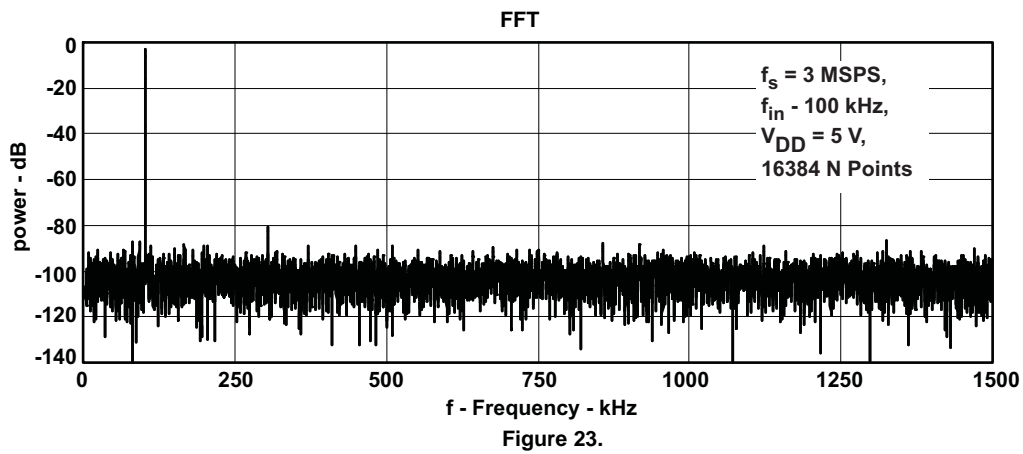

Figure 23.

TYPICAL CHARACTERISTICS ADS7885

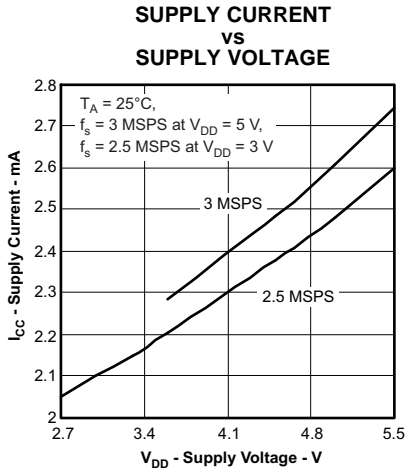

Figure 24.

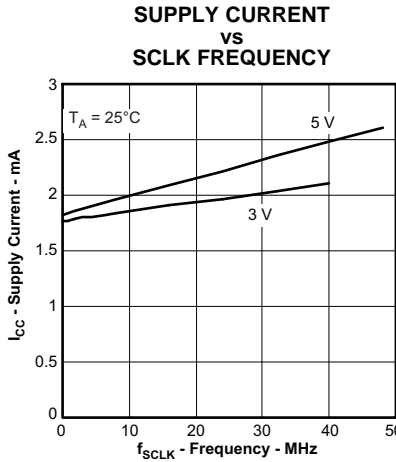

Figure 25.

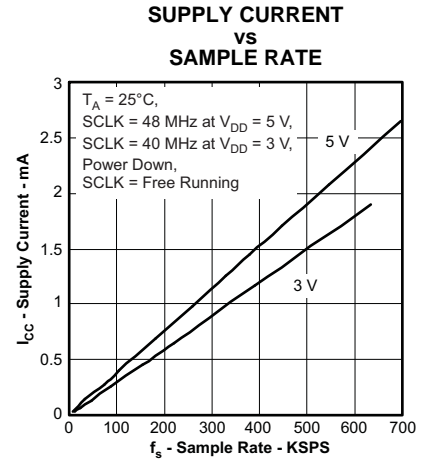

Figure 26.

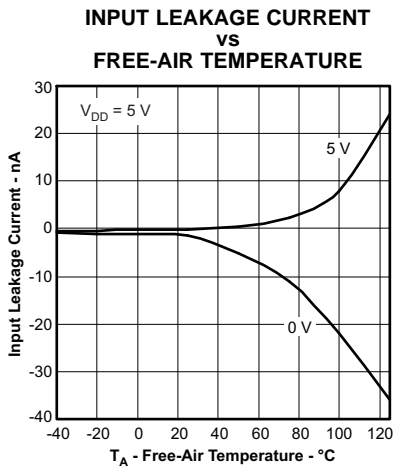

Figure 27.

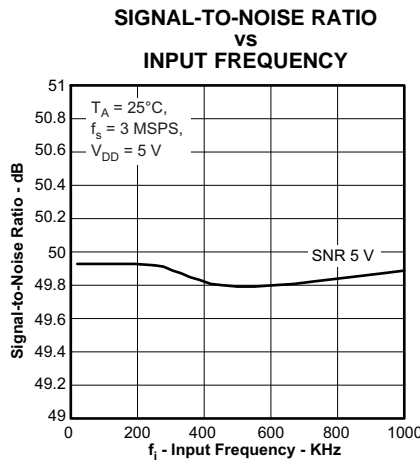

Figure 28.

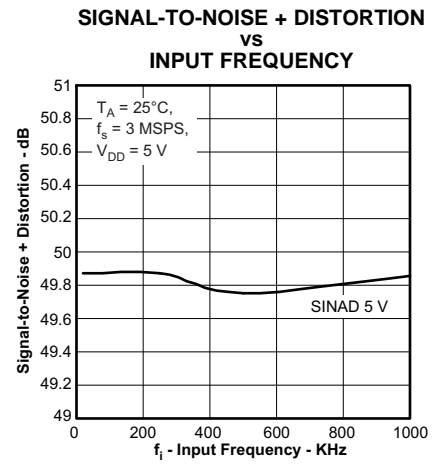

Figure 29.

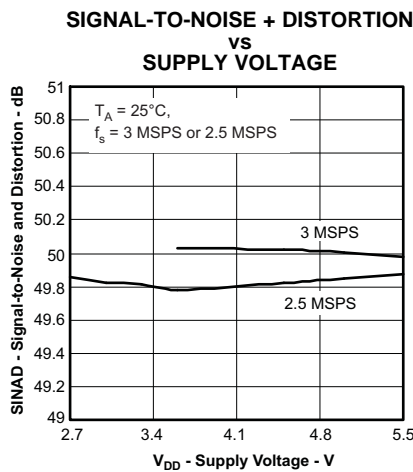

Figure 30.

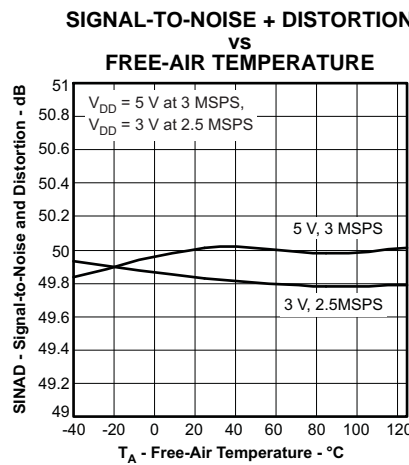

Figure 31.

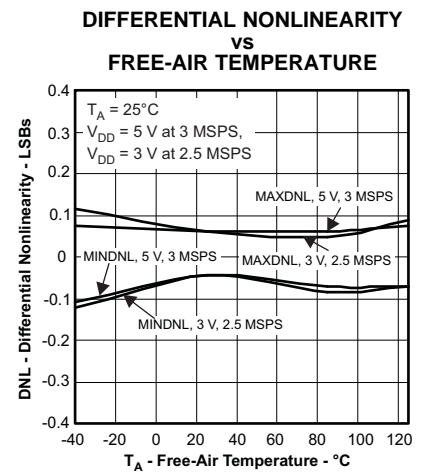

Figure 32.

TYPICAL CHARACTERISTICS ADS7885 (continued)

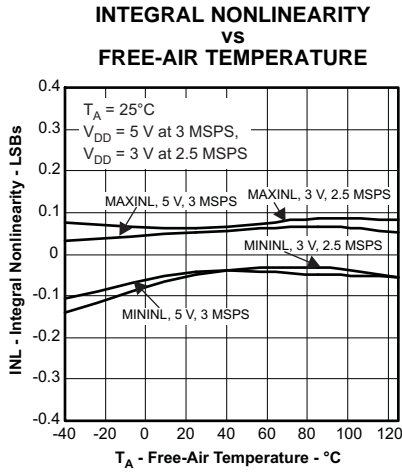

Figure 33.

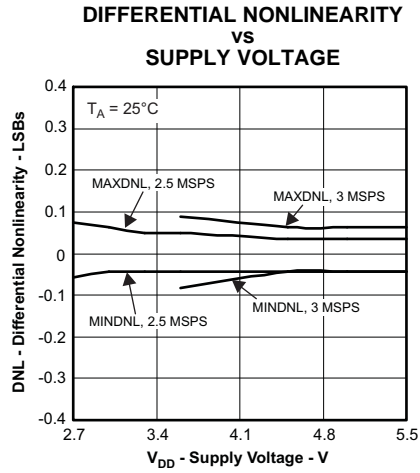

Figure 34.

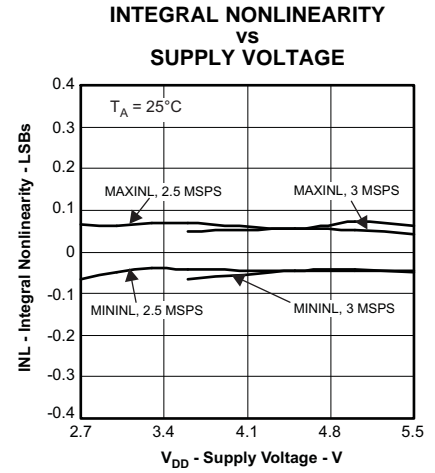

Figure 35.

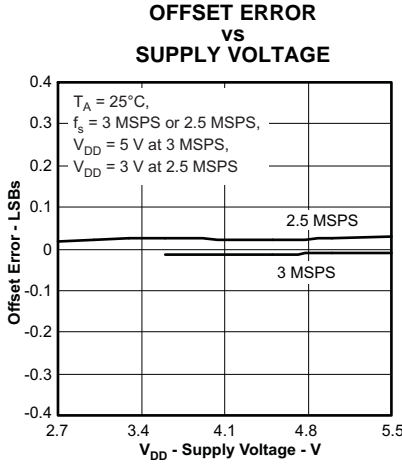

Figure 36.

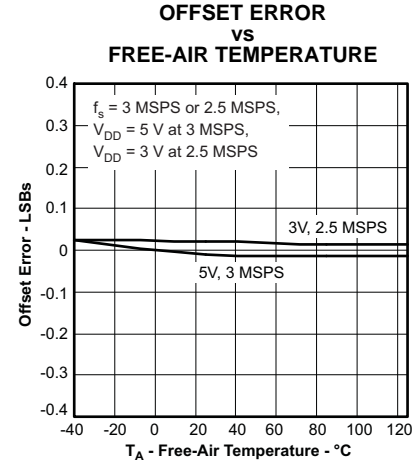

Figure 37.

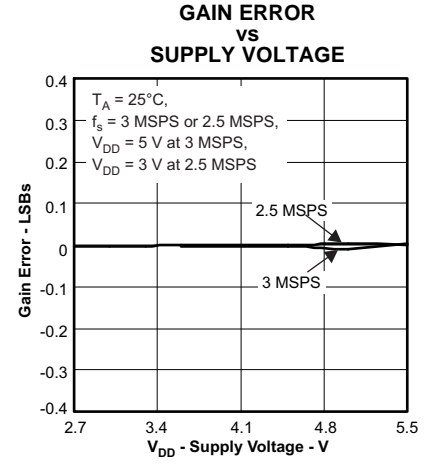

Figure 38.

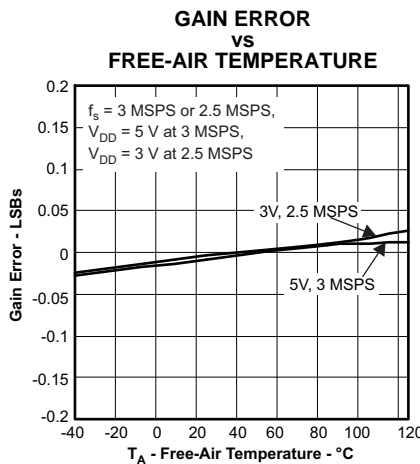

Figure 39.

TYPICAL CHARACTERISTICS ADS7885 (continued)

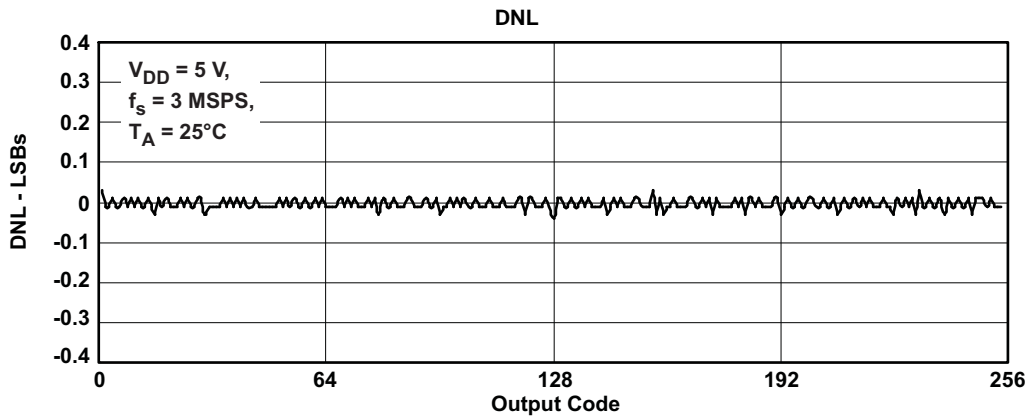

Figure 40.

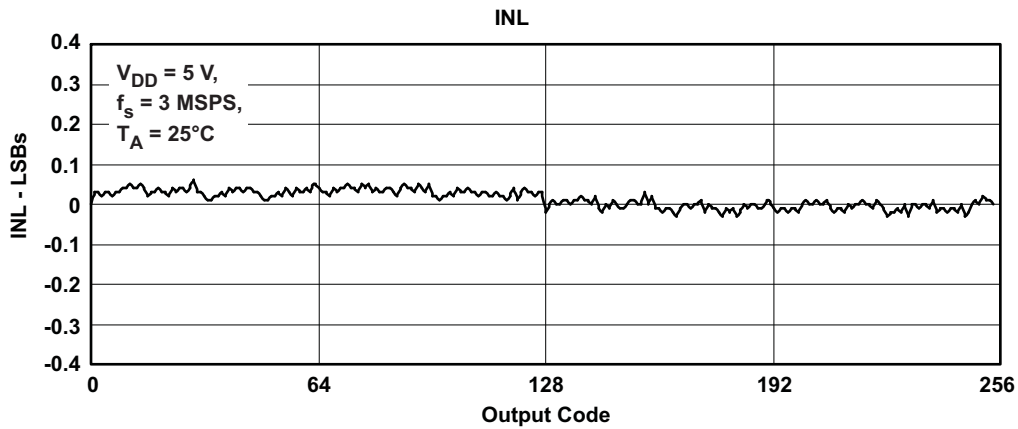

Figure 41.

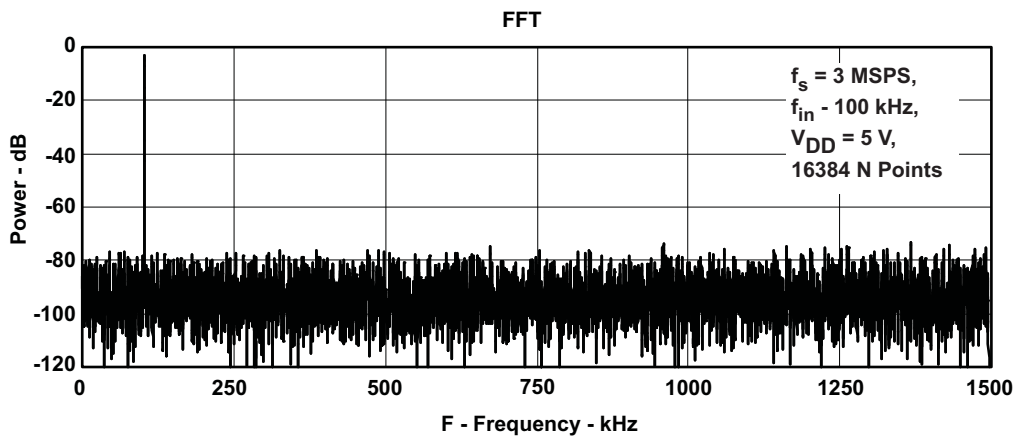

Figure 42.

APPLICATION INFORMATION

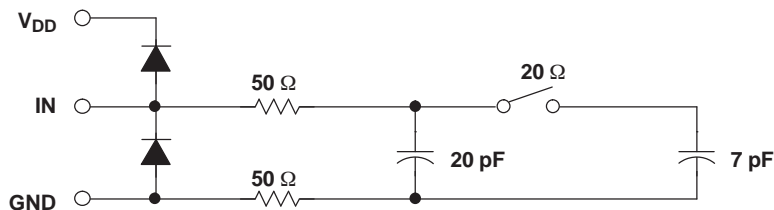

Figure 43. Typical Equivalent Sampling Circuit

Driving the VIN and V_{DD} Pins of the ADS7884 and ADS7885

The VIN input to the ADS7884 and ADS7885 should be driven with a low impedance source. In most cases additional buffers are not required. In cases where the source impedance exceeds 200 Ω, using a buffer would help achieve the rated performance of the converter. The THS4031 is a good choice for the driver amplifier buffer.

The reference voltage for the ADS7884 and ADS7885 A/D converters are derived from the supply voltage internally. The devices offer limited low-pass filtering functionality on-chip. The supply to these converters should be driven with a low impedance source and should be decoupled to the ground. A 1-μF storage capacitor and a 10-nF decoupling capacitor should be placed close to the device. Wide, low impedance traces should be used to connect the capacitor to the pins of the device. The ADS7884 and ADS7885 draw very little current from the supply lines. The supply line can be driven by either:

- Directly from the system supply.
- A reference output from a low drift and low drop out reference voltage generator like REF3030 or REF3130. The ADS7884 and ADS7885 can operate off a wide range of supply voltages. The actual choice of the reference voltage generator would depend upon the system. Figure 45 shows one possible application circuit.
- A low-pass filtered version of the system supply followed by a buffer like the zero-drift OPA735 can also be used in cases where the system power supply is noisy. Care should be taken to ensure that the voltage at the V_{DD} input does not exceed 7 V (especially during power up) to avoid damage to the converter. This can be done easily using single supply CMOS amplifiers like the OPA735. Figure 46 shows one possible application circuit.

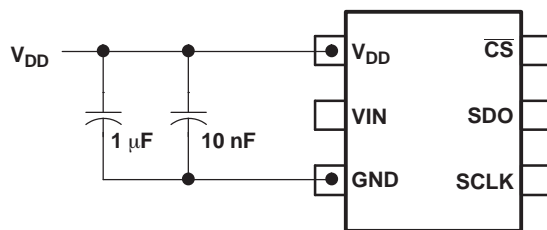

Figure 44. Supply/Reference Decoupling Capacitors

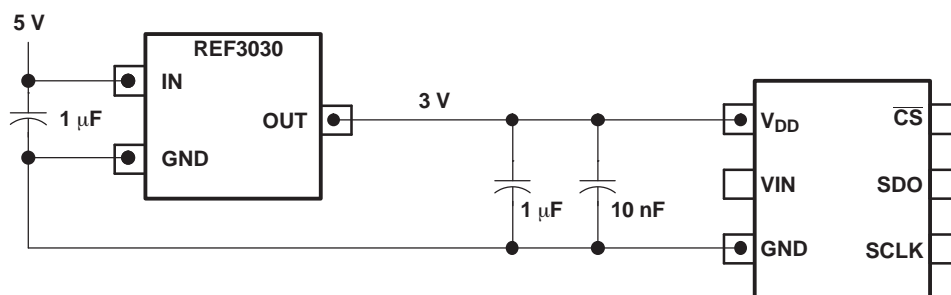

Figure 45. Using the REF3030 Reference

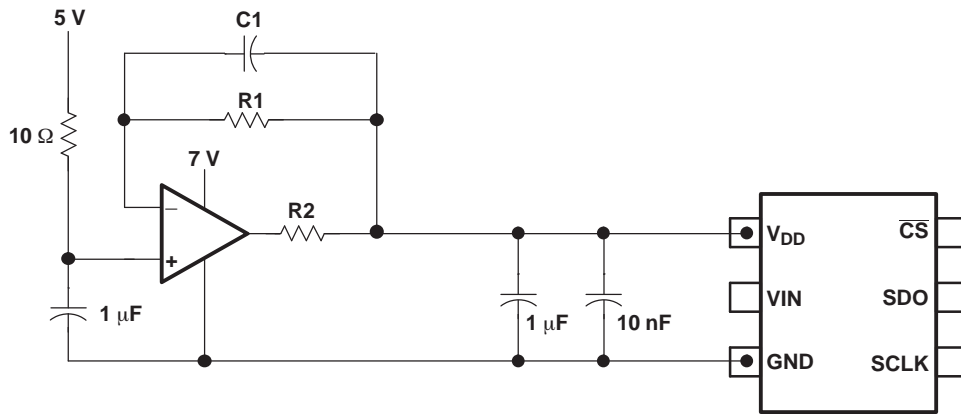

Figure 46. Buffering with the OPA735

PACKAGING INFORMATION

Orderable Device	Status (1)	Package Type	Package Drawing	Pins	Package Qty	Eco Plan (2)	Lead/Ball Finish	MSL Peak Temp (3)	Op Temp (°C)	Top-Side Markings (4)	Samples
ADS7884SDBVR	ACTIVE	SOT-23	DBV	6	3000	Pb-Free (RoHS Exempt)	CU NIPDAU	Level-2-260C-1 YEAR		7884	Samples
ADS7884SDBVT	ACTIVE	SOT-23	DBV	6	250	Pb-Free (RoHS Exempt)	CU NIPDAU	Level-2-260C-1 YEAR		7884	Samples
ADS7885SDBVR	ACTIVE	SOT-23	DBV	6	3000	Pb-Free (RoHS Exempt)	CU NIPDAU	Level-2-260C-1 YEAR		7885	Samples
ADS7885SDBVT	ACTIVE	SOT-23	DBV	6	250	Pb-Free (RoHS Exempt)	CU NIPDAU	Level-2-260C-1 YEAR		7885	Samples

(1) The marketing status values are defined as follows:

ACTIVE: Product device recommended for new designs.

LIFEBUY: TI has announced that the device will be discontinued, and a lifetime-buy period is in effect.

NRND: Not recommended for new designs. Device is in production to support existing customers, but TI does not recommend using this part in a new design.

PREVIEW: Device has been announced but is not in production. Samples may or may not be available.

OBSOLETE: TI has discontinued the production of the device.

(2) Eco Plan - The planned eco-friendly classification: Pb-Free (RoHS), Pb-Free (RoHS Exempt), or Green (RoHS & no Sb/Br) - please check <http://www.ti.com/productcontent> for the latest availability information and additional product content details.

TBD: The Pb-Free/Green conversion plan has not been defined.

Pb-Free (RoHS): TI's terms "Lead-Free" or "Pb-Free" mean semiconductor products that are compatible with the current RoHS requirements for all 6 substances, including the requirement that lead not exceed 0.1% by weight in homogeneous materials. Where designed to be soldered at high temperatures, TI Pb-Free products are suitable for use in specified lead-free processes.

Pb-Free (RoHS Exempt): This component has a RoHS exemption for either 1) lead-based flip-chip solder bumps used between the die and package, or 2) lead-based die adhesive used between the die and leadframe. The component is otherwise considered Pb-Free (RoHS compatible) as defined above.

Green (RoHS & no Sb/Br): TI defines "Green" to mean Pb-Free (RoHS compatible), and free of Bromine (Br) and Antimony (Sb) based flame retardants (Br or Sb do not exceed 0.1% by weight in homogeneous material)

(3) MSL, Peak Temp. -- The Moisture Sensitivity Level rating according to the JEDEC industry standard classifications, and peak solder temperature.

(4) Only one of markings shown within the brackets will appear on the physical device.

Important Information and Disclaimer: The information provided on this page represents TI's knowledge and belief as of the date that it is provided. TI bases its knowledge and belief on information provided by third parties, and makes no representation or warranty as to the accuracy of such information. Efforts are underway to better integrate information from third parties. TI has taken and continues to take reasonable steps to provide representative and accurate information but may not have conducted destructive testing or chemical analysis on incoming materials and chemicals. TI and TI suppliers consider certain information to be proprietary, and thus CAS numbers and other limited information may not be available for release.

In no event shall TI's liability arising out of such information exceed the total purchase price of the TI part(s) at issue in this document sold by TI to Customer on an annual basis.

TAPE AND REEL INFORMATION

QUADRANT ASSIGNMENTS FOR PIN 1 ORIENTATION IN TAPE

*All dimensions are nominal

Device	Package Type	Package Drawing	Pins	SPQ	Reel Diameter (mm)	Reel Width W1 (mm)	A0 (mm)	B0 (mm)	K0 (mm)	P1 (mm)	W (mm)	Pin1 Quadrant
ADS7884SDBVR	SOT-23	DBV	6	3000	177.8	9.7	3.2	3.1	1.39	4.0	8.0	Q3
ADS7884SDBVT	SOT-23	DBV	6	250	177.8	9.7	3.2	3.1	1.39	4.0	8.0	Q3
ADS7885SDBVR	SOT-23	DBV	6	3000	177.8	9.7	3.2	3.1	1.39	4.0	8.0	Q3
ADS7885SDBVT	SOT-23	DBV	6	250	177.8	9.7	3.2	3.1	1.39	4.0	8.0	Q3

TAPE AND REEL BOX DIMENSIONS

*All dimensions are nominal

Device	Package Type	Package Drawing	Pins	SPQ	Length (mm)	Width (mm)	Height (mm)
ADS7884SDBVR	SOT-23	DBV	6	3000	184.0	184.0	50.0
ADS7884SDBVT	SOT-23	DBV	6	250	184.0	184.0	50.0
ADS7885SDBVR	SOT-23	DBV	6	3000	184.0	184.0	50.0
ADS7885SDBVT	SOT-23	DBV	6	250	184.0	184.0	50.0

DBV (R-PDSO-G6)

PLASTIC SMALL-OUTLINE PACKAGE

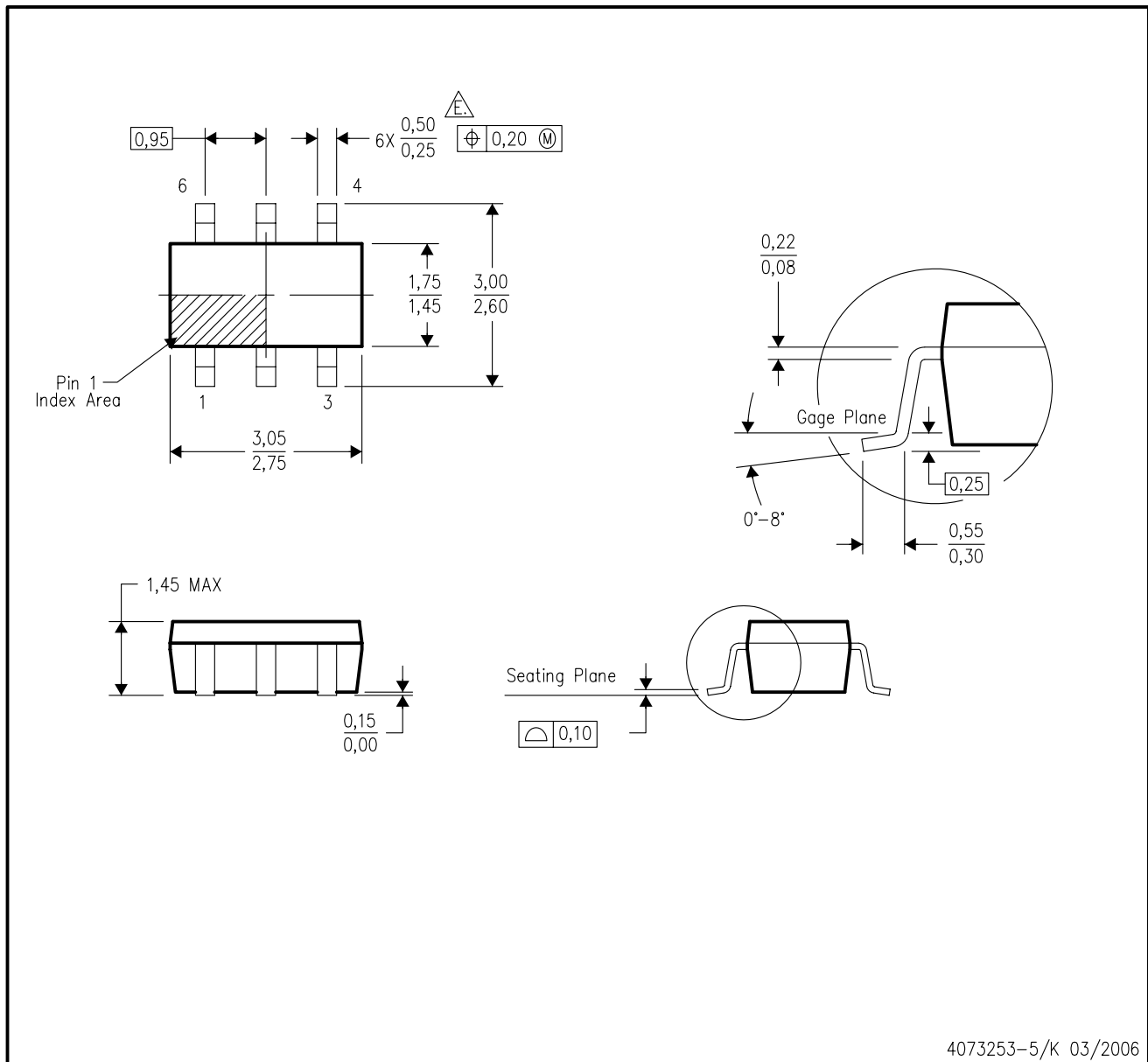

- NOTES:
- A. All linear dimensions are in millimeters.
 - B. This drawing is subject to change without notice.
 - C. Body dimensions do not include mold flash or protrusion. Mold flash and protrusion shall not exceed 0.15 per side.
 - D. Leads 1,2,3 may be wider than leads 4,5,6 for package orientation.
- $\frac{0,20}{M}$ Falls within JEDEC MO-178 Variation AB, except minimum lead width.

DBV (R-PDSO-G6)

PLASTIC SMALL OUTLINE

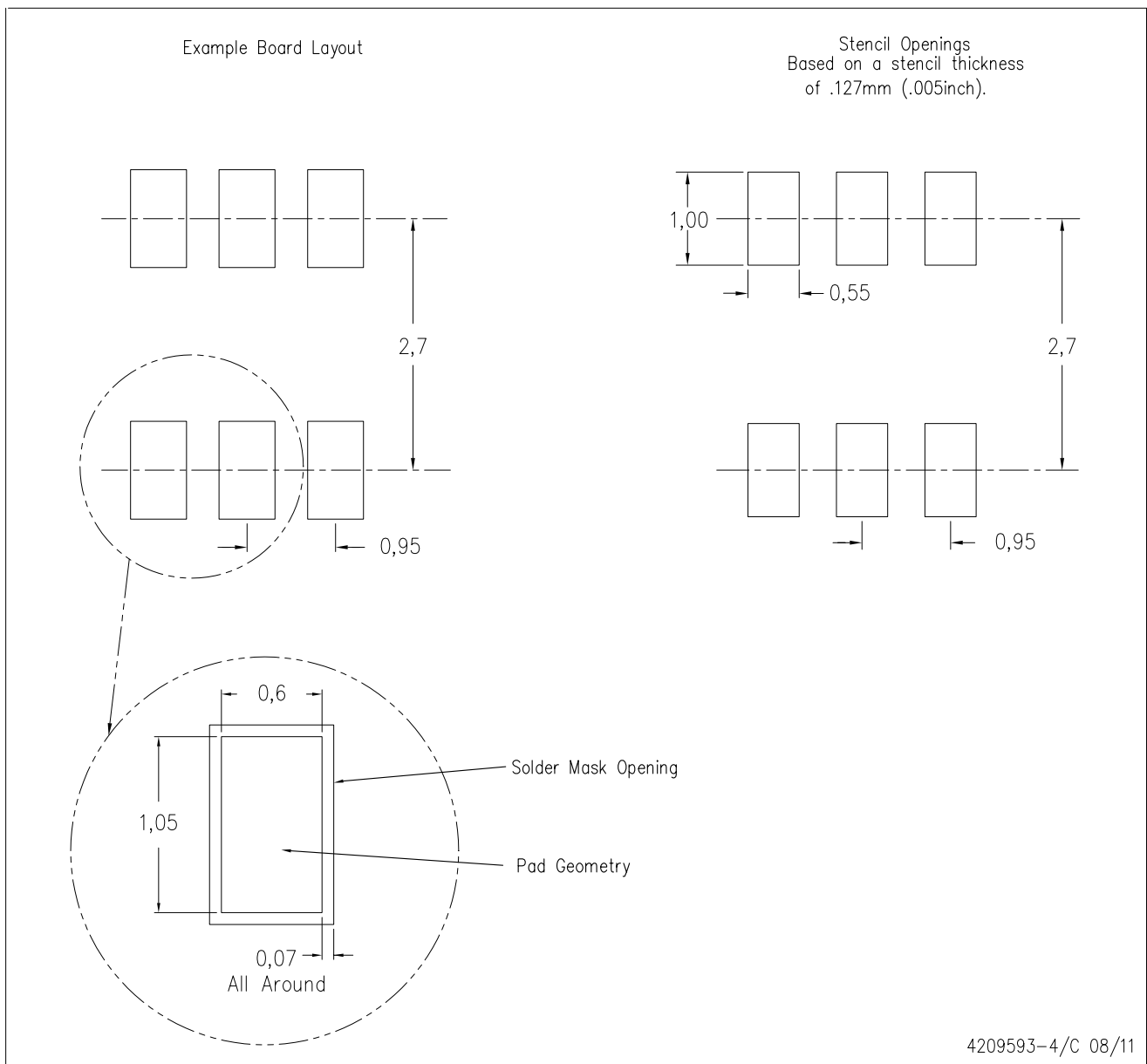

- NOTES:
- A. All linear dimensions are in millimeters.
 - B. This drawing is subject to change without notice.
 - C. Customers should place a note on the circuit board fabrication drawing not to alter the center solder mask defined pad.
 - D. Publication IPC-7351 is recommended for alternate designs.
 - E. Laser cutting apertures with trapezoidal walls and also rounding corners will offer better paste release. Customers should contact their board assembly site for stencil design recommendations. Example stencil design based on a 50% volumetric metal load solder paste. Refer to IPC-7525 for other stencil recommendations.

IMPORTANT NOTICE

Texas Instruments Incorporated and its subsidiaries (TI) reserve the right to make corrections, enhancements, improvements and other changes to its semiconductor products and services per JESD46, latest issue, and to discontinue any product or service per JESD48, latest issue. Buyers should obtain the latest relevant information before placing orders and should verify that such information is current and complete. All semiconductor products (also referred to herein as "components") are sold subject to TI's terms and conditions of sale supplied at the time of order acknowledgment.

TI warrants performance of its components to the specifications applicable at the time of sale, in accordance with the warranty in TI's terms and conditions of sale of semiconductor products. Testing and other quality control techniques are used to the extent TI deems necessary to support this warranty. Except where mandated by applicable law, testing of all parameters of each component is not necessarily performed.

TI assumes no liability for applications assistance or the design of Buyers' products. Buyers are responsible for their products and applications using TI components. To minimize the risks associated with Buyers' products and applications, Buyers should provide adequate design and operating safeguards.

TI does not warrant or represent that any license, either express or implied, is granted under any patent right, copyright, mask work right, or other intellectual property right relating to any combination, machine, or process in which TI components or services are used. Information published by TI regarding third-party products or services does not constitute a license to use such products or services or a warranty or endorsement thereof. Use of such information may require a license from a third party under the patents or other intellectual property of the third party, or a license from TI under the patents or other intellectual property of TI.

Reproduction of significant portions of TI information in TI data books or data sheets is permissible only if reproduction is without alteration and is accompanied by all associated warranties, conditions, limitations, and notices. TI is not responsible or liable for such altered documentation. Information of third parties may be subject to additional restrictions.

Resale of TI components or services with statements different from or beyond the parameters stated by TI for that component or service voids all express and any implied warranties for the associated TI component or service and is an unfair and deceptive business practice. TI is not responsible or liable for any such statements.

Buyer acknowledges and agrees that it is solely responsible for compliance with all legal, regulatory and safety-related requirements concerning its products, and any use of TI components in its applications, notwithstanding any applications-related information or support that may be provided by TI. Buyer represents and agrees that it has all the necessary expertise to create and implement safeguards which anticipate dangerous consequences of failures, monitor failures and their consequences, lessen the likelihood of failures that might cause harm and take appropriate remedial actions. Buyer will fully indemnify TI and its representatives against any damages arising out of the use of any TI components in safety-critical applications.

In some cases, TI components may be promoted specifically to facilitate safety-related applications. With such components, TI's goal is to help enable customers to design and create their own end-product solutions that meet applicable functional safety standards and requirements. Nonetheless, such components are subject to these terms.

No TI components are authorized for use in FDA Class III (or similar life-critical medical equipment) unless authorized officers of the parties have executed a special agreement specifically governing such use.

Only those TI components which TI has specifically designated as military grade or "enhanced plastic" are designed and intended for use in military/aerospace applications or environments. Buyer acknowledges and agrees that any military or aerospace use of TI components which have **not** been so designated is solely at the Buyer's risk, and that Buyer is solely responsible for compliance with all legal and regulatory requirements in connection with such use.

TI has specifically designated certain components as meeting ISO/TS16949 requirements, mainly for automotive use. In any case of use of non-designated products, TI will not be responsible for any failure to meet ISO/TS16949.

Products

Audio	www.ti.com/audio
Amplifiers	amplifier.ti.com
Data Converters	dataconverter.ti.com
DLP® Products	www.dlp.com
DSP	dsp.ti.com
Clocks and Timers	www.ti.com/clocks
Interface	interface.ti.com
Logic	logic.ti.com
Power Mgmt	power.ti.com
Microcontrollers	microcontroller.ti.com
RFID	www.ti-rfid.com
OMAP Applications Processors	www.ti.com/omap
Wireless Connectivity	www.ti.com/wirelessconnectivity

Applications

Automotive and Transportation	www.ti.com/automotive
Communications and Telecom	www.ti.com/communications
Computers and Peripherals	www.ti.com/computers
Consumer Electronics	www.ti.com/consumer-apps
Energy and Lighting	www.ti.com/energy
Industrial	www.ti.com/industrial
Medical	www.ti.com/medical
Security	www.ti.com/security
Space, Avionics and Defense	www.ti.com/space-avionics-defense
Video and Imaging	www.ti.com/video

TI E2E Community

e2e.ti.com