

6.25-Gbps Cable and PC Board Equalizer

Check for Samples: [TLK6201EA](#)

FEATURES

- **Multirate Operation up to 6.25 Gbps**
- **Compensates for up to 13-dB Loss on the Receive Side and up to 12-dB Loss on the Transmit Side at 3.125 GHz**
- **Suitable to Receive and Transmit 6.25-Gbps Data Over up to 60 Inches (1.5 Meters) of FR4 PC Boards**
- **Suitable to Receive and Transmit 6.25-Gbps Data Over up to 63 Feet (19.2 Meters) of 24-AWG Cable**
- **Ultralow Power Consumption**
- **Input Offset Cancellation**
- **High Input Dynamic Range**
- **Output Disable/Squelch Function**
- **Loss of Signal Detection**
- **Output Swing Select**
- **Output De-Emphasis Select**
- **Output Polarity Select**
- **CML Data Outputs**
- **Single 3.3-V Supply**
- **Surface-Mount, Small-Footprint, 3-mm × 3-mm, 16-Pin QFN Package**

APPLICATIONS

- **High-Speed Links in Communication and Data Systems**
- **Backplane, Daughtercard, and Cable Interconnects for PCI Express, InfiniBand, SAS, CEI, XAUI, Fibre Channel, and Ethernet**

DESCRIPTION

The TLK6201EA is a versatile, high-speed, limiting equalizer for applications in digital high-speed links with data rates up to 6.25 Gbps.

This device provides a high-frequency boost of 13 dB on the received data at 3.125 GHz, as well as sufficient gain to ensure a fully differential output swing for input signals as low as 100 mVp-p (at the input of a lossy interconnect line).

Four de-emphasis levels can be selected on the transmit side to provide up to 12 dB of additional high-frequency loss compensation.

The high input-signal dynamic range ensures low-jitter output signals even when overdriven with input signal swings as high as 2000 mVp-p.

The TLK6201EA implements fixed loss-of-signal detection, which can be used to implement a squelch function by connecting the LOS output to the adjacent DIS input.

The TLK6201EA is available in a small-footprint, 3-mm × 3-mm, 16-pin QFN package. It requires a single 3.3-V supply.

This power-efficient equalizer is characterized for operation from –40°C to 85°C.



Please be aware that an important notice concerning availability, standard warranty, and use in critical applications of Texas Instruments semiconductor products and disclaimers thereto appears at the end of this data sheet.



These devices have limited built-in ESD protection. The leads should be shorted together or the device placed in conductive foam during storage or handling to prevent electrostatic damage to the MOS gates.

BLOCK DIAGRAM

A simplified block diagram of the TLK6201EA is shown in Figure 1. This compact, low-power, 6.25-Gbps equalizer consists of a high-speed data path with offset cancellation circuitry, a loss-of-signal detection block, and a band-gap voltage reference and bias current generation block. The equalizer requires a single 3.3-V $\pm 10\%$ supply voltage. All circuit parts are described in detail as follows.

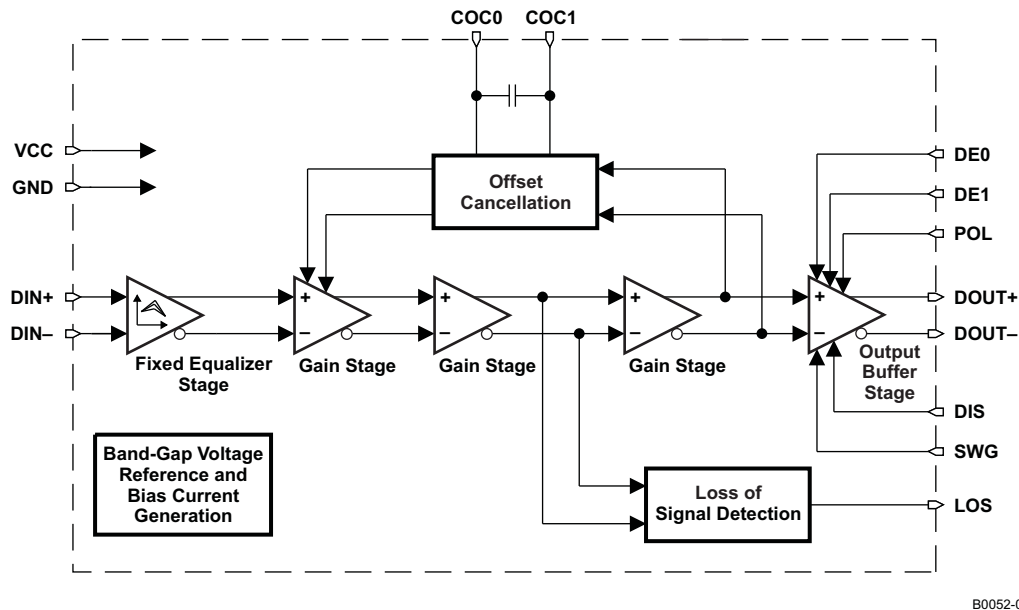

Figure 1. Simplified Block Diagram of the TLK6201EA

HIGH-SPEED DATA PATH

The high-speed data signal with frequency-dependent loss is applied to the data path by means of the input signal pins DIN+/DIN-. The data path consists of the fixed equalizer input stage, three gain stages which provide the required gain to ensure a limited-output signal, and an output buffer stage. The equalized and amplified data output signal is available at the output pins DOUT+/DOUT-, which provide $2 \times 50\text{-}\Omega$ back-termination to VCC. The output stage also includes a data polarity-switching function, which is controlled by the POL input, and a disable function, controlled by the signal applied to the DIS input pin.

The output swing can be increased 50% by applying a high-level signal to the SWG pin.

Up to 12 dB of output signal de-emphasis can be selected using the pins DE0 and DE1.

An offset cancellation compensates the inevitable internal offset voltages and thus ensures proper operation even for very small input data signals.

The low-frequency cutoff is as low as 3.5 kHz with the built-in filter capacitor. For applications which require even lower cutoff frequencies, an additional external filter capacitor can be connected to the COC0/COC1 pins.

LOSS-OF-SIGNAL DETECTION

The output signal of the second gain stage is monitored by the loss-of-signal detection circuitry. In this block, the input signal is compared to a fixed threshold. If the low frequency components of the input signal fall below this threshold, a loss of signal is indicated at the LOS pin.

A squelch function can be easily implemented by connecting the LOS output to the adjacent DIS input. This measure avoids chattering of the output when no input signal is present.

BAND-GAP VOLTAGE AND BIAS GENERATION

The TLK6201EA equalizer is supplied by a single 3.3-V $\pm 10\%$ supply voltage connected to the VCC pins. This voltage is referred to ground (GND).

An on-chip band-gap voltage circuit generates a supply-voltage-independent reference from which all internally required voltages and bias currents are derived.

DEVICE INFORMATION

The TLK6201EA is available in a small-footprint, 3-mm \times 3-mm, 16-pin QFN package, with a lead pitch of 0.5 mm. The pinout is shown in [Figure 2](#).

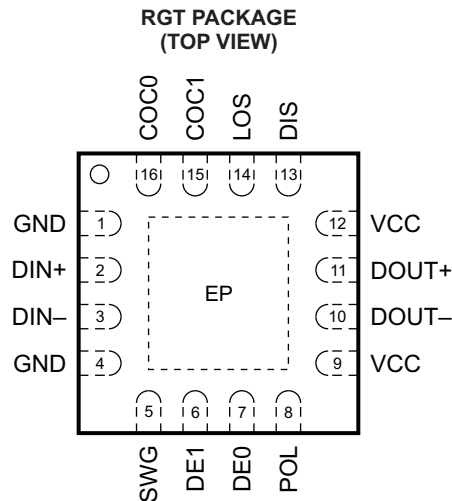

P0019-04

Figure 2. Pinout of TLK6201EA

Table 1. PIN FUNCTIONS

PIN		TYPE	DESCRIPTION
NAME	NO.		
COC0	16	Analog	Offset cancellation filter capacitor terminal 2. Connect an additional filter capacitor between this pin and COC1 (pin 15). To disable the offset cancellation loop, connect COC1 and COC0 (pins 15 and 16).
COC1	15	Analog	Offset cancellation filter capacitor terminal 1. Connect an additional filter capacitor between this pin and COC0 (pin 16). To disable the offset cancellation loop, connect COC1 and COC0 (pins 15 and 16).
DE0	7	CMOS in	Selects 4 dB of output signal de-emphasis when set to high level. Internally pulled up.
DE1	6	CMOS in	Selects 8 dB of output signal de-emphasis when set to high level. Internally pulled up.
DIN+	2	Analog in	Noninverted data input. On-chip load terminated to ground. Connect a 100- Ω differential transmission line to terminals DIN+ and DIN-.
DIN-	3	Analog in	Inverted data input. On-chip load terminated to ground. Connect a 100- Ω differential transmission line to terminals DIN+ and DIN-.
DIS	13	CMOS in	Disables CML output stage when set to high level. Internally pulled down.
DOUT+	11	CML out	Noninverted data output. On-chip 50- Ω back-terminated to VCC.
DOUT-	10	CML out	Inverted data output. On-chip 50- Ω back-terminated to VCC.
GND	1, 4, EP	Supply	Circuit ground. Exposed die pad (EP) must be grounded.
LOS	14	CMOS out	High level indicates that the input signal amplitude is below the fixed threshold level.
POL	8	CMOS in	Output data signal polarity select (internally pulled up): Setting to high level or leaving pin open selects normal polarity. Low level selects inverted polarity.
SWG	5	CMOS in	Output swing control. The output swing is increased by 50% when set to high level. Internally pulled down.
VCC	9, 12	Supply	3.3-V, $\pm 10\%$ supply voltage

ABSOLUTE MAXIMUM RATINGS

over operating free-air temperature range (unless otherwise noted) ⁽¹⁾

		VALUE ⁽¹⁾	UNIT
V _{CC}	Supply voltage ⁽²⁾	–0.3 to 4	V
V _{DIN+} , V _{DIN–}	Voltage at DIN+, DIN– ⁽²⁾	0.5 to 4	V
V _{DIS} , V _{POL} , V _{DE1} , V _{DE0} , V _{SWG} , V _{COC1} , V _{COC0}	Voltage at DIS, POL, DE1, DE0, SWG, COC1, COC0 ⁽²⁾	–0.3 to 4	V
V _{COC,DIFF}	Differential input voltage between COC1 and COC0	±1	V
V _{DIN,DIFF}	Differential input voltage between DIN+ and DIN–	±2.5	V
I _{DIN+} , I _{DIN–} , I _{DOUT+} , I _{DOUT–}	Continuous current at inputs and outputs	±25	mA
ESD	ESD ratings at all pins, human body model (HBM)	3	kV
T _{J,max}	Maximum junction temperature	125	°C
T _{stg}	Storage temperature range	–65 to 150	°C
T _A	Characterized free-air operating temperature range	–40 to 85	°C

- (1) Stresses beyond those listed under *Absolute Maximum Ratings* may cause permanent damage to the device. These are stress ratings only, and functional operation of the device at these or any other conditions beyond those indicated under *Recommended Operating Conditions* is not implied. Exposure to absolute-maximum-rated conditions for extended periods may affect device reliability.
- (2) All voltage values are with respect to network ground terminal.

RECOMMENDED OPERATING CONDITIONS

over operating free-air temperature range (unless otherwise noted)

		MIN	NOM	MAX	UNIT
V _{CC}	Supply voltage	3	3.3	3.6	V
T _A	Free-air operating temperature	–40		85	°C
V _{IH}	High-level input voltage, CMOS	2			V
V _{IL}	Low-level input voltage, CMOS			0.8	V

DC ELECTRICAL CHARACTERISTICS

over recommended operating conditions (unless otherwise noted)

PARAMETER	TEST CONDITIONS	MIN	TYP	MAX	UNIT
V _{CC}	Supply voltage	3	3.3	3.6	V
I _{CC}	DIS = SWG = low (includes CML output current)		45	54	mA
	DIS = low, SWG = high (includes CML output current)		55	67	
R _{OUT}	Output resistance, data		50		Ω
	LOS high voltage	I _{source} = 1 mA	2.5		V
	LOS low voltage	I _{sink} = 1 mA		0.5	V

AC ELECTRICAL CHARACTERISTICS

over operating free-air temperature range (unless otherwise noted)

 Typical operating condition is at $V_{CC} = 3.3\text{ V}$ and $T_A = 25^\circ\text{C}$.

PARAMETER		TEST CONDITIONS	MIN	TYP	MAX	UNIT
Low frequency –3-dB bandwidth		$C_{OC} = \text{open}$		3.5	10	kHz
		$C_{OC} = 100\text{ nF}$		0.8		
Maximum data rate			6.25			Gbps
$V_{IN,MIN}$	Data input sensitivity ⁽¹⁾	BER < 10^{-12} , K28.5 pattern at 6.25 Gbps over a 36-inch, 7-mil-wide stripline on standard FR4, including two through-hole SMA connectors. Voltage measured at the input of the interconnect line.		40	50	mV _{P-P}
$V_{IN,MAX}$	Data input overload	Voltage at the input of an interconnect line	2000			mV _{P-P}
	High-frequency boost	$f = 3.125\text{ GHz}$ (fixed input equalizer)	12	14	17	dB
V_{OD}	Differential data output voltage swing	DIS = low, SWG = low	600	800	1000	mV _{P-P}
		DIS = low, SWG = high	900	1200	1500	
V_{RIP}	Differential output ripple	DIS = high, 50% transitions of K28.5 pattern at 6.25 Gbps, no interconnect line, $V_{IN} = 2000\text{ mVp-p}$		0.25	10	mV _{RMS}
$V_{CM,OUT}$	Data output, common-mode voltage	DIS = low, SWG = low, dc-coupled 50 Ω to V_{CC} , single-ended terminations	$V_{CC} - 0.25$	$V_{CC} - 0.2$	$V_{CC} - 0.15$	V
		DIS = low, SWG = high, dc-coupled 50 Ω to V_{CC} , single-ended terminations	$V_{CC} - 0.375$	$V_{CC} - 0.3$	$V_{CC} - 0.225$	
DE	Output de-emphasis (see Figure 3)	DE0 = low, DE1 = low		0		dB
		DE0 = high, DE1 = low		–4		
		DE0 = low, DE1 = high		–8		
		DE0 = high, DE1 = high		–12		
DJ	Deterministic jitter	K28.5 pattern at 6.25 Gbps, no interconnect line, $V_{IN} = 400\text{ mVp-p}$, DE0 = low, DE1 = low, SWG = low		8		ps _{P-P}
		K28.5 pattern at 6.25 Gbps over a 36-inch, 7-mil-wide stripline on standard FR4 including two through-hole SMA connectors, $V_{IN} = 400\text{ mVp-p}$ (voltage at the input of the interconnect line), DE0 = low, DE1 = low, SWG = low		12		
RJ	Random jitter	K28.5 pattern at 6.25 Gbps over a 36-inch, 7-mil-wide stripline on standard FR4 including two through-hole SMA connectors, $V_{IN} = 400\text{ mVp-p}$ (voltage at the input of the interconnect line), DE0 = low, DE1 = low, SWG = low		1		ps _{RMS}
t_r	Output rise time	20% to 80%, no interconnect line, DE0 = low, DE1 = low		35	55	ps
t_f	Output fall time	20% to 80%, no interconnect line, DE0 = low, DE1 = low		35	55	ps
S11	Input return loss	10 Hz < f < 3.1 GHz		–15		dB
S22	Output return loss	10 Hz < f < 3.1 GHz		–12		dB

(1) The given differential input signal swing is valid for the low-frequency components of the input signal. The high-frequency components may be attenuated by up to 13 dB at 3.125 GHz.

AC ELECTRICAL CHARACTERISTICS (continued)

over operating free-air temperature range (unless otherwise noted)
 Typical operating condition is at $V_{CC} = 3.3\text{ V}$ and $T_A = 25^\circ\text{C}$.

PARAMETER	TEST CONDITIONS	MIN	TYP	MAX	UNIT
V_{AS} LOS assert threshold voltage	K28.5 pattern at 6.25 Gbps over a 36-inch, 7-mil-wide stripline on standard FR4 including two through-hole SMA connectors. Voltage measured at the input of the interconnect line. ⁽²⁾	40	75		mV _{P-P}
V_{DAS} LOS de-assert threshold voltage	K28.5 pattern at 6.25 Gbps over a 36-inch, 7-mil-wide stripline on standard FR4 including two through-hole SMA connectors. Voltage measured at the input of the interconnect line. ⁽²⁾		130	250	mV _{P-P}
LOS hysteresis	$20 \log(V_{DAS}/V_{AS})$ ⁽²⁾	2	4.5		dB
$t_{AS/DAS}$ LOS assert/de-assert time		2		100	μs
t_{DIS} Disable response time			20		ns
Latency	From DIN+/DIN- to DOUT+/DOUT-		150		ps

(2) This specification is for 0°C to 85°C. Depending on the interconnect line length and performance, the bit pattern, and the data rate, the assert and de-assert threshold voltage levels vary. For more information, see the *Typical Characteristics* section.

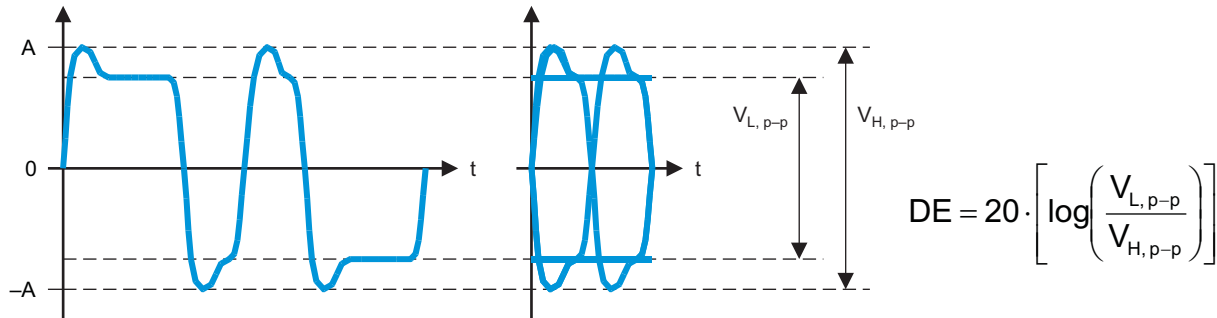

T0157-01

Figure 3. Output Signal De-Emphasis

APPLICATION INFORMATION

Figure 4 shows the TLK6201EA connected with an ac-coupled interface to the data signal source via a stripline transmission line on FR4 material. The output load is ac-coupled as well.

The ac-coupling capacitors C_1 through C_4 in the input and output data signal lines are the only required external components. In addition, if a very low cutoff frequency is required, as an option, an external filter capacitor C_{OC} may be used.

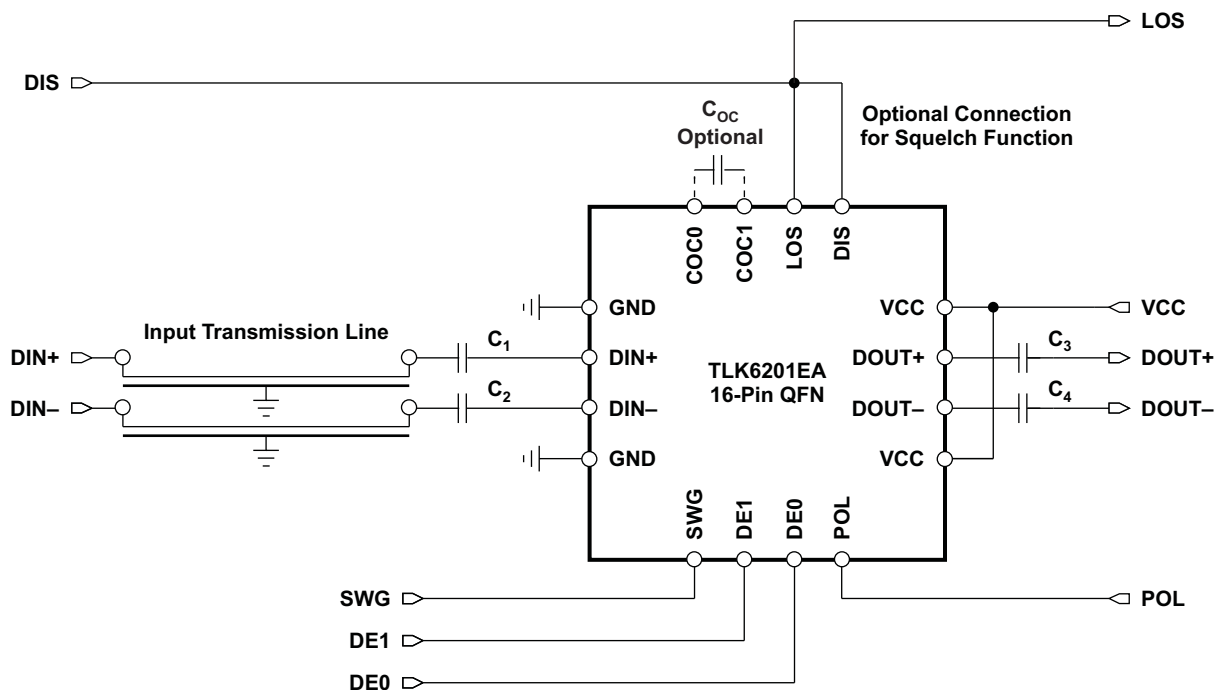

S0072-04

Figure 4. Basic Application Circuit with AC-Coupled I/Os

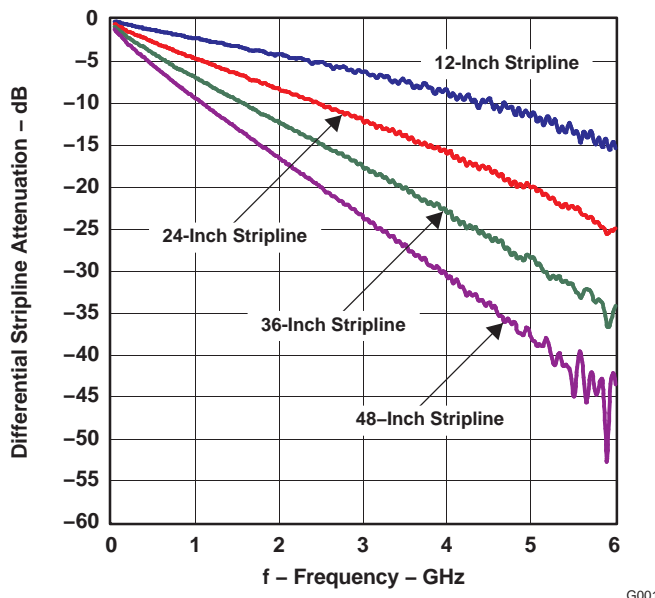

G001

Figure 5. Attenuation Characteristics of Stripline Interconnect Lines

TYPICAL CHARACTERISTICS

Typical operating condition is at $V_{CC} = 3.3\text{ V}$, $T_A = 25^\circ\text{C}$, $V_{IN} = 400\text{ mVp-p}$, $DE0 = \text{low}$, $DE1 = \text{low}$, $SWG = \text{low}$, and no interconnect line at the output (unless otherwise noted).

DIFFERENTIAL EQUALIZER INPUT SIGNAL (TOP) AND OUTPUT SIGNAL (BOTTOM) AT 6.25 GBPS USING A K28.5 PATTERN

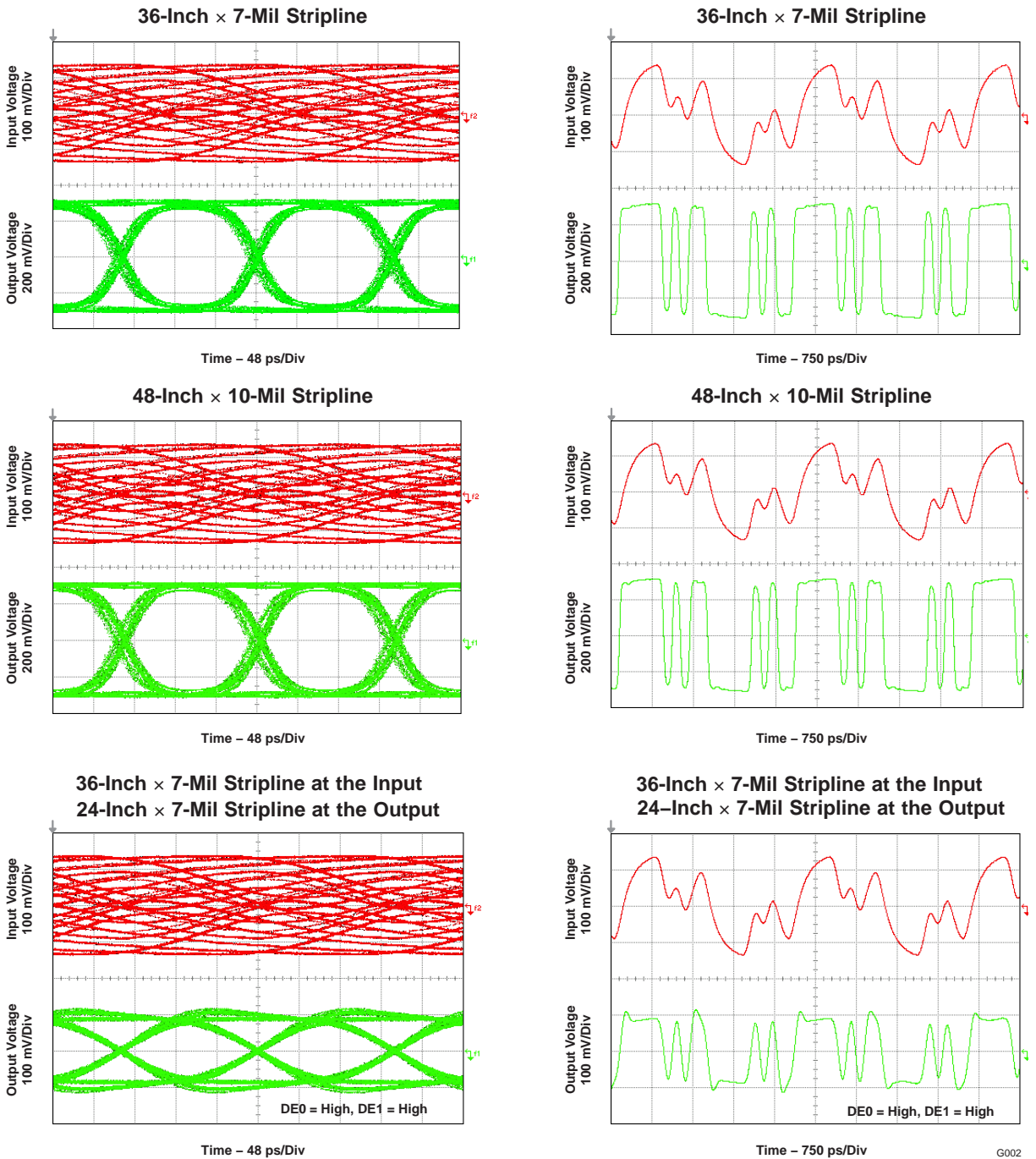

Figure 6. Equalizer Input and Output Signals With Different Interconnect Lines at 6.25 Gbps

TYPICAL CHARACTERISTICS (continued)

Typical operating condition is at $V_{CC} = 3.3\text{ V}$, $T_A = 25^\circ\text{C}$, $V_{IN} = 400\text{ mVp-p}$, DE0 = low, DE1 = low, SWG = low, and no interconnect line at the output (unless otherwise noted).

DIFFERENTIAL EQUALIZER INPUT SIGNAL (TOP) AND OUTPUT SIGNAL (BOTTOM) AT 4.25 GBPS USING A K28.5 PATTERN

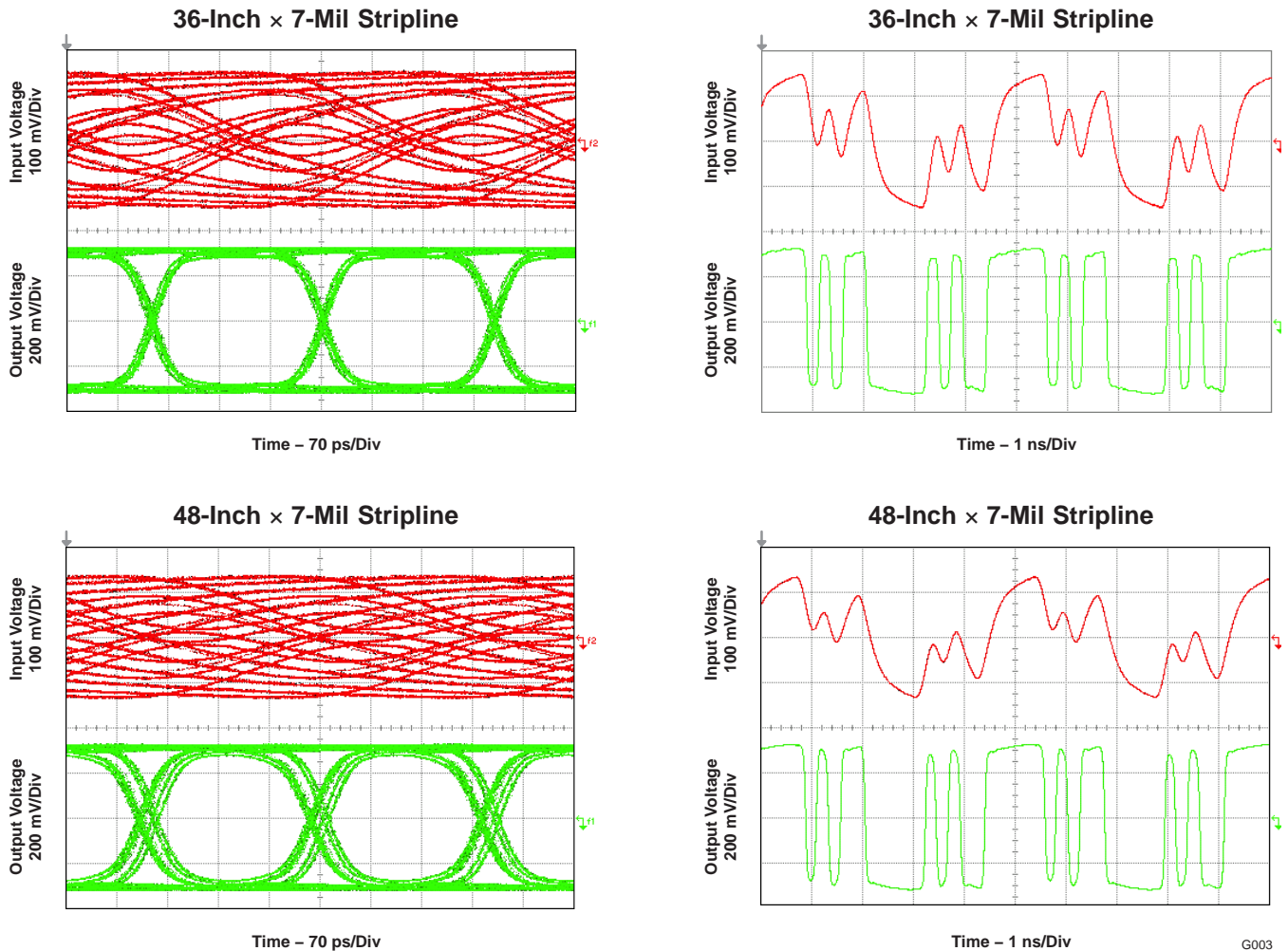

Figure 7. Equalizer Input and Output Signals With Different Interconnect Lines at 4.25 Gbps

TYPICAL CHARACTERISTICS (continued)

Typical operating condition is at $V_{CC} = 3.3\text{ V}$, $T_A = 25^\circ\text{C}$, $V_{IN} = 400\text{ mVp-p}$, DE0 = low, DE1 = low, SWG = low, and no interconnect line at the output (unless otherwise noted).

DIFFERENTIAL EQUALIZER INPUT SIGNAL (TOP) AND OUTPUT SIGNAL (BOTTOM) AT 2.125 GBPS USING A K28.5 PATTERN

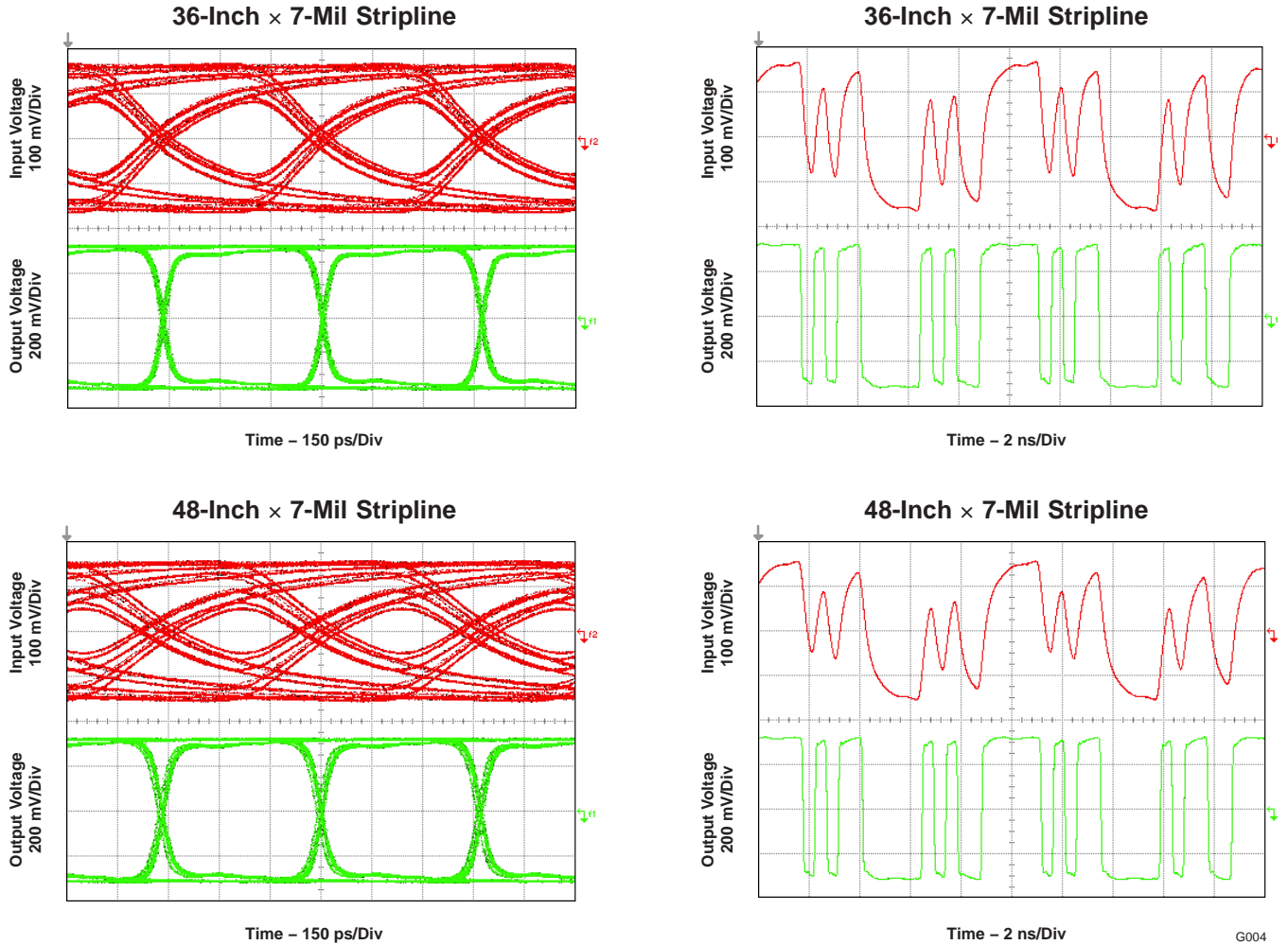

Figure 8. Equalizer Input and Output Signals With Different Interconnect Lines at 2.125 Gbps

TYPICAL CHARACTERISTICS (continued)

Typical operating condition is at $V_{CC} = 3.3\text{ V}$, $T_A = 25^\circ\text{C}$, $V_{IN} = 400\text{ mVp-p}$, DE0 = low, DE1 = low, SWG = low, and no interconnect line at the output (unless otherwise noted).

Typical operating condition is at $V_{CC} = 3.3\text{ V}$, $T_A = 25^\circ\text{C}$, DE0 = low, DE1 = low, SWG = low, and no interconnect line at the output (unless otherwise noted).

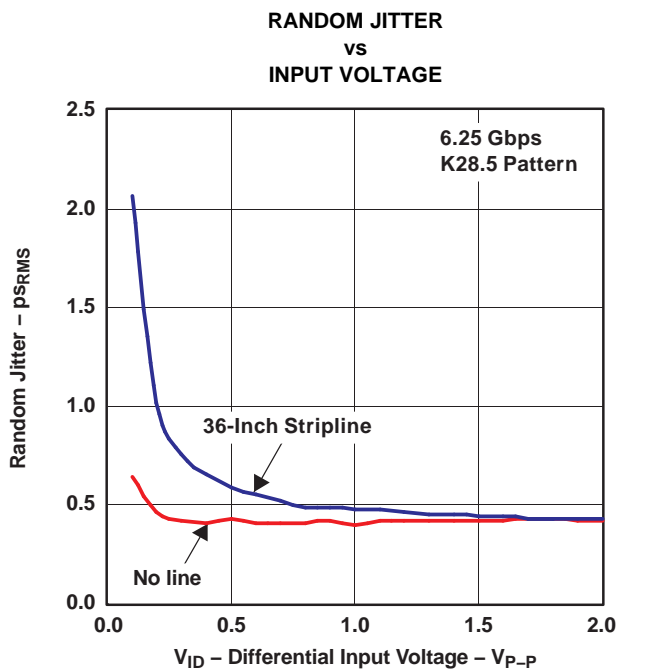

Figure 9.

G005

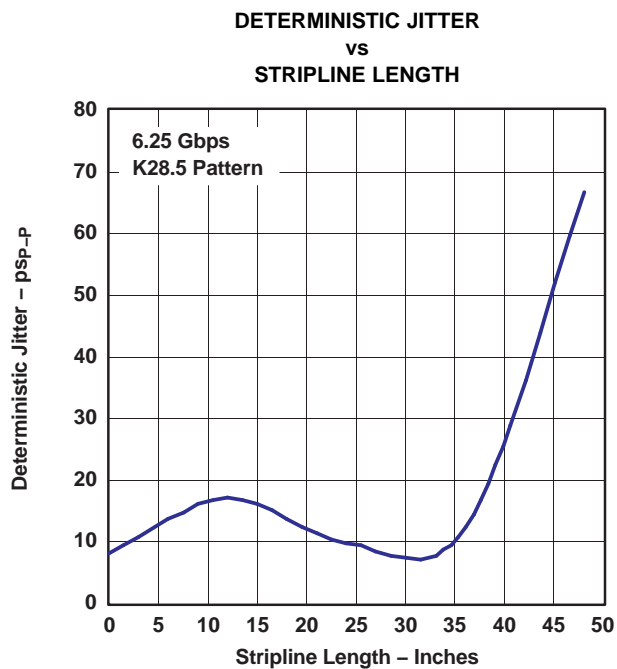

Figure 10.

G006

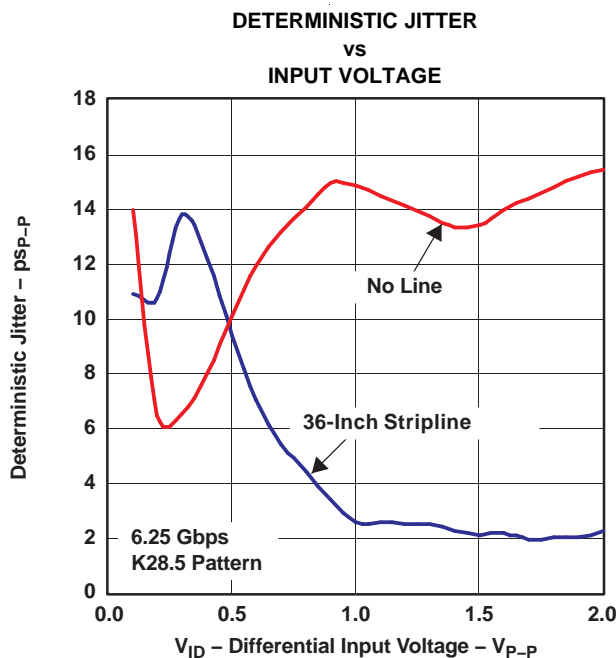

Figure 11.

G007

TYPICAL CHARACTERISTICS (continued)

Typical operating condition is at $V_{CC} = 3.3\text{ V}$, $T_A = 25^\circ\text{C}$, DE0 = low, DE1 = low, SWG = low, and no interconnect line at the output (unless otherwise noted).

**DIFFERENTIAL INPUT RETURN LOSS
vs
FREQUENCY**

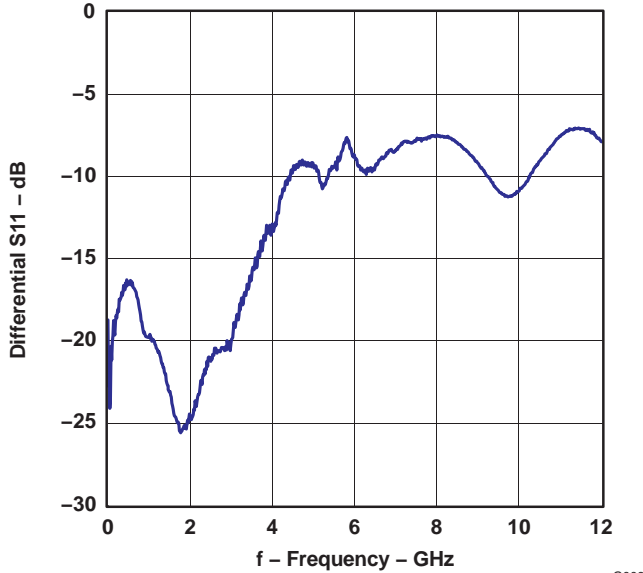

Figure 12.

G008

**DIFFERENTIAL OUTPUT RETURN LOSS
vs
FREQUENCY**

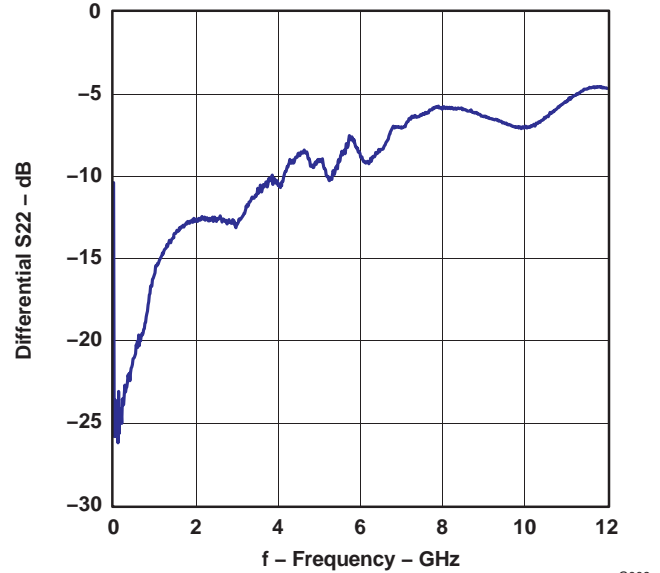

Figure 13.

G009

**LOS ASSERT THRESHOLD VOLTAGE
vs
DATA RATE**

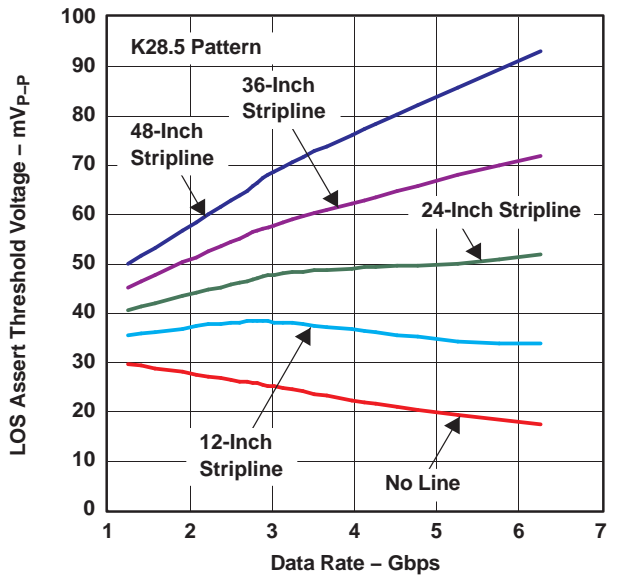

Figure 14.

G010

**LOS DE-ASSERT THRESHOLD VOLTAGE
vs
DATA RATE**

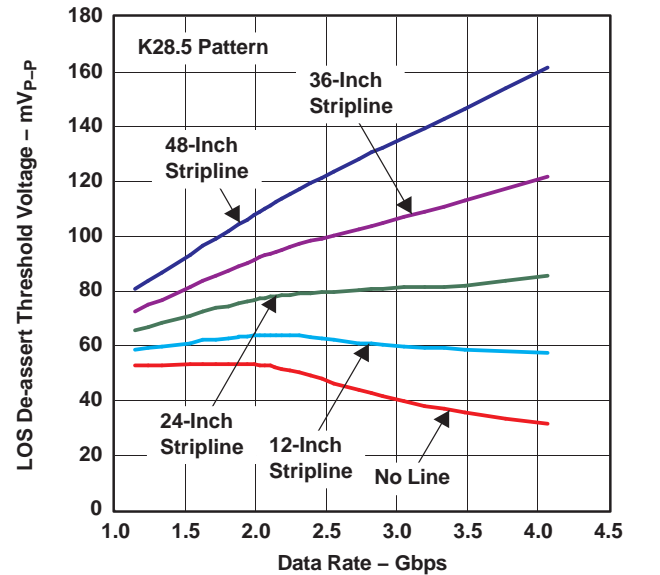

Figure 15.

G011

REVISION HISTORY



Changes from Original (August 2006) to Revision A **Page**

-
- Changed the LOS hysteresis MIN value From: 2.5 dB To: 2 dB [6](#)
-

Changes from Revision A (October 2007) to Revision B **Page**

-
- Changed the T_{stg} , storage temperature range From: -65 to 85°C To: -65 to 150°C [4](#)
-

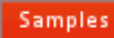
PACKAGING INFORMATION

Orderable Device	Status (1)	Package Type	Package Drawing	Pins	Package Qty	Eco Plan (2)	Lead/Ball Finish	MSL Peak Temp (3)	Op Temp (°C)	Top-Side Markings (4)	Samples
TLK6201EARGTR	ACTIVE	QFN	RGT	16	3000	Green (RoHS & no Sb/Br)	CU NIPDAUAG	Level-2-260C-1 YEAR		620E	
TLK6201EARGTRG4	ACTIVE	QFN	RGT	16	3000	Green (RoHS & no Sb/Br)	CU NIPDAUAG	Level-2-260C-1 YEAR		620E	
TLK6201EARGTT	ACTIVE	QFN	RGT	16	250	Green (RoHS & no Sb/Br)	CU NIPDAUAG	Level-2-260C-1 YEAR		620E	
TLK6201EARGTTG4	ACTIVE	QFN	RGT	16	250	Green (RoHS & no Sb/Br)	CU NIPDAUAG	Level-2-260C-1 YEAR		620E	

(1) The marketing status values are defined as follows:

ACTIVE: Product device recommended for new designs.

LIFEBUY: TI has announced that the device will be discontinued, and a lifetime-buy period is in effect.

NRND: Not recommended for new designs. Device is in production to support existing customers, but TI does not recommend using this part in a new design.

PREVIEW: Device has been announced but is not in production. Samples may or may not be available.

OBSOLETE: TI has discontinued the production of the device.

(2) Eco Plan - The planned eco-friendly classification: Pb-Free (RoHS), Pb-Free (RoHS Exempt), or Green (RoHS & no Sb/Br) - please check <http://www.ti.com/productcontent> for the latest availability information and additional product content details.

TBD: The Pb-Free/Green conversion plan has not been defined.

Pb-Free (RoHS): TI's terms "Lead-Free" or "Pb-Free" mean semiconductor products that are compatible with the current RoHS requirements for all 6 substances, including the requirement that lead not exceed 0.1% by weight in homogeneous materials. Where designed to be soldered at high temperatures, TI Pb-Free products are suitable for use in specified lead-free processes.

Pb-Free (RoHS Exempt): This component has a RoHS exemption for either 1) lead-based flip-chip solder bumps used between the die and package, or 2) lead-based die adhesive used between the die and leadframe. The component is otherwise considered Pb-Free (RoHS compatible) as defined above.

Green (RoHS & no Sb/Br): TI defines "Green" to mean Pb-Free (RoHS compatible), and free of Bromine (Br) and Antimony (Sb) based flame retardants (Br or Sb do not exceed 0.1% by weight in homogeneous material)

(3) MSL, Peak Temp. -- The Moisture Sensitivity Level rating according to the JEDEC industry standard classifications, and peak solder temperature.

(4) Only one of markings shown within the brackets will appear on the physical device.

Important Information and Disclaimer: The information provided on this page represents TI's knowledge and belief as of the date that it is provided. TI bases its knowledge and belief on information provided by third parties, and makes no representation or warranty as to the accuracy of such information. Efforts are underway to better integrate information from third parties. TI has taken and continues to take reasonable steps to provide representative and accurate information but may not have conducted destructive testing or chemical analysis on incoming materials and chemicals. TI and TI suppliers consider certain information to be proprietary, and thus CAS numbers and other limited information may not be available for release.

In no event shall TI's liability arising out of such information exceed the total purchase price of the TI part(s) at issue in this document sold by TI to Customer on an annual basis.

TAPE AND REEL INFORMATION



QUADRANT ASSIGNMENTS FOR PIN 1 ORIENTATION IN TAPE



*All dimensions are nominal

Device	Package Type	Package Drawing	Pins	SPQ	Reel Diameter (mm)	Reel Width W1 (mm)	A0 (mm)	B0 (mm)	K0 (mm)	P1 (mm)	W (mm)	Pin1 Quadrant
TLK6201EARGTR	QFN	RGT	16	3000	330.0	12.4	3.3	3.3	1.1	8.0	12.0	Q2
TLK6201EARGTT	QFN	RGT	16	250	180.0	12.4	3.3	3.3	1.1	8.0	12.0	Q2

TAPE AND REEL BOX DIMENSIONS

*All dimensions are nominal

Device	Package Type	Package Drawing	Pins	SPQ	Length (mm)	Width (mm)	Height (mm)
TLK6201EARGTR	QFN	RGT	16	3000	367.0	367.0	35.0
TLK6201EARGTT	QFN	RGT	16	250	210.0	185.0	35.0

RGT (S-PVQFN-N16)

PLASTIC QUAD FLATPACK NO-LEAD

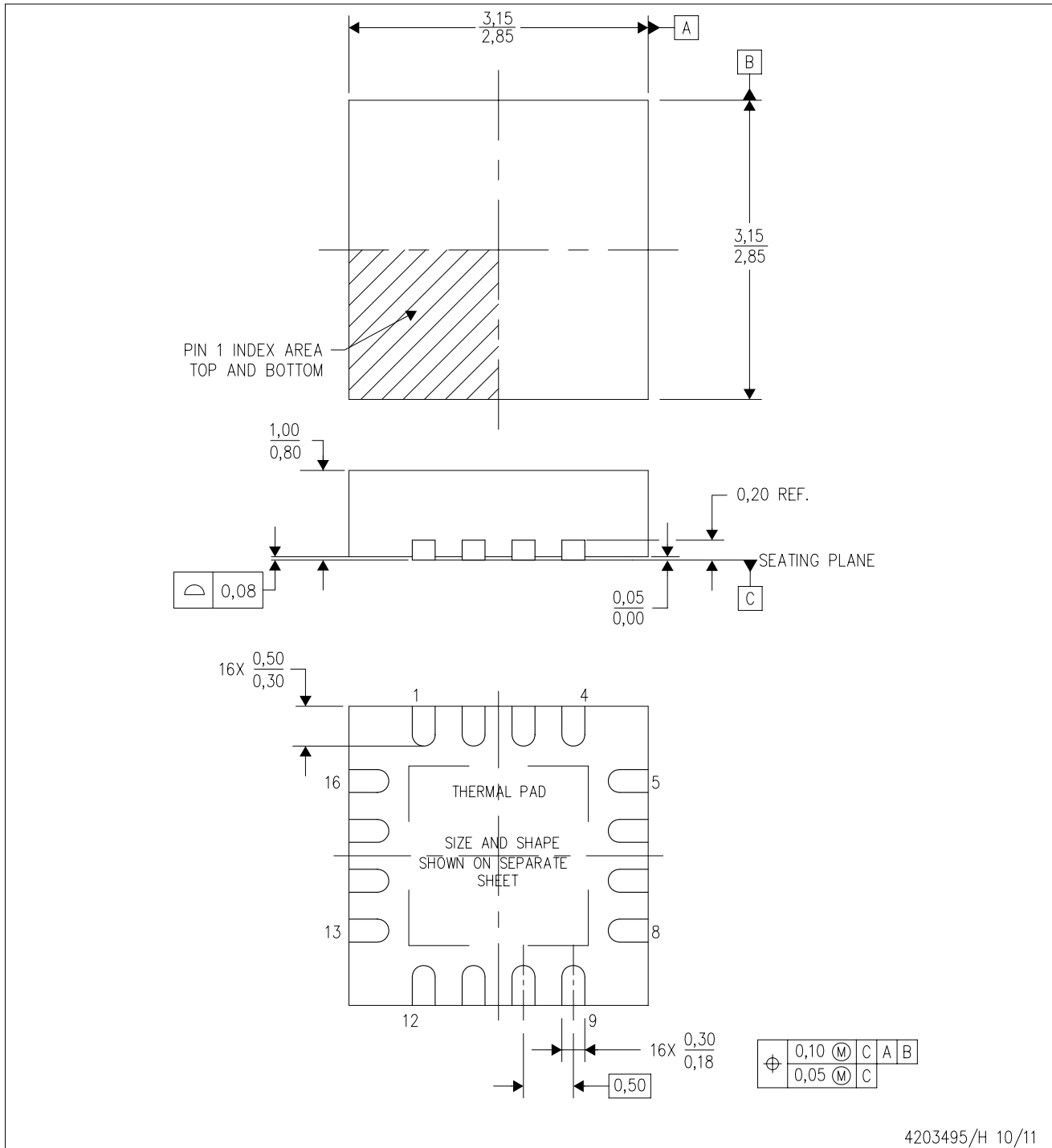

4203495/H 10/11

- NOTES:
- All linear dimensions are in millimeters. Dimensioning and tolerancing per ASME Y14.5M-1994.
 - This drawing is subject to change without notice.
 - Quad Flatpack, No-leads (QFN) package configuration.
 - The package thermal pad must be soldered to the board for thermal and mechanical performance.
 - See the additional figure in the Product Data Sheet for details regarding the exposed thermal pad features and dimensions.
 - Falls within JEDEC MO-220.

THERMAL PAD MECHANICAL DATA

RGT (S-PVQFN-N16)

PLASTIC QUAD FLATPACK NO-LEAD

THERMAL INFORMATION

This package incorporates an exposed thermal pad that is designed to be attached directly to an external heatsink. The thermal pad must be soldered directly to the printed circuit board (PCB). After soldering, the PCB can be used as a heatsink. In addition, through the use of thermal vias, the thermal pad can be attached directly to the appropriate copper plane shown in the electrical schematic for the device, or alternatively, can be attached to a special heatsink structure designed into the PCB. This design optimizes the heat transfer from the integrated circuit (IC).

For information on the Quad Flatpack No-Lead (QFN) package and its advantages, refer to Application Report, QFN/SON PCB Attachment, Texas Instruments Literature No. SLUA271. This document is available at www.ti.com.

The exposed thermal pad dimensions for this package are shown in the following illustration.

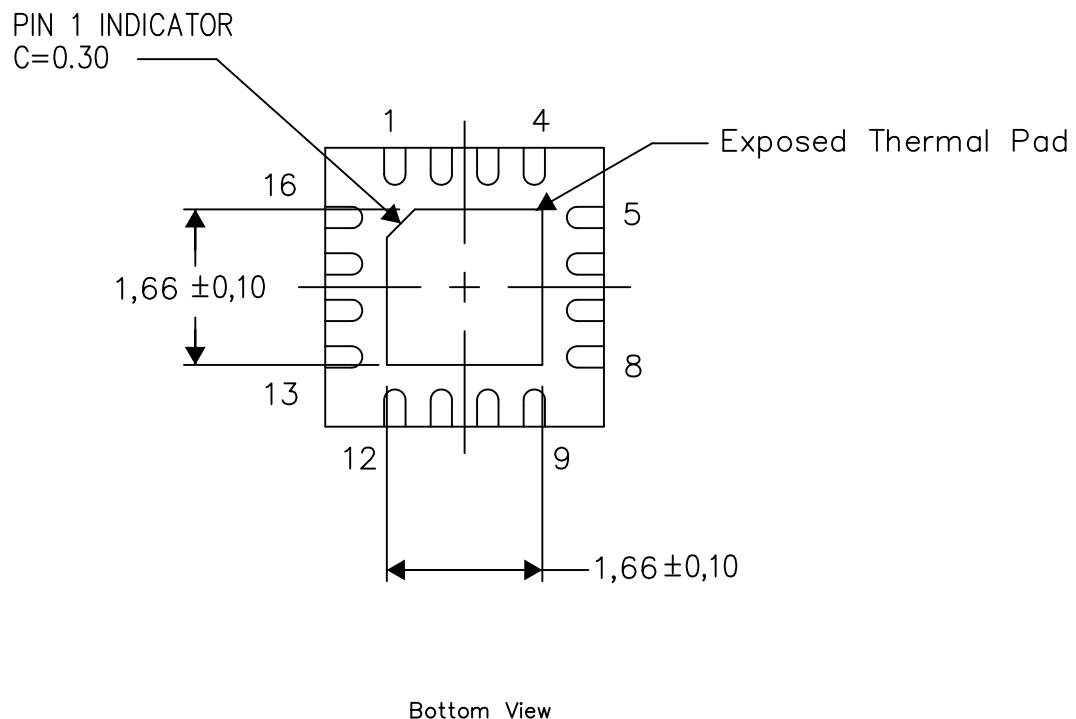

Exposed Thermal Pad Dimensions

4206349-9/T 05/13

NOTE: All linear dimensions are in millimeters

IMPORTANT NOTICE

Texas Instruments Incorporated and its subsidiaries (TI) reserve the right to make corrections, enhancements, improvements and other changes to its semiconductor products and services per JESD46, latest issue, and to discontinue any product or service per JESD48, latest issue. Buyers should obtain the latest relevant information before placing orders and should verify that such information is current and complete. All semiconductor products (also referred to herein as "components") are sold subject to TI's terms and conditions of sale supplied at the time of order acknowledgment.

TI warrants performance of its components to the specifications applicable at the time of sale, in accordance with the warranty in TI's terms and conditions of sale of semiconductor products. Testing and other quality control techniques are used to the extent TI deems necessary to support this warranty. Except where mandated by applicable law, testing of all parameters of each component is not necessarily performed.

TI assumes no liability for applications assistance or the design of Buyers' products. Buyers are responsible for their products and applications using TI components. To minimize the risks associated with Buyers' products and applications, Buyers should provide adequate design and operating safeguards.

TI does not warrant or represent that any license, either express or implied, is granted under any patent right, copyright, mask work right, or other intellectual property right relating to any combination, machine, or process in which TI components or services are used. Information published by TI regarding third-party products or services does not constitute a license to use such products or services or a warranty or endorsement thereof. Use of such information may require a license from a third party under the patents or other intellectual property of the third party, or a license from TI under the patents or other intellectual property of TI.

Reproduction of significant portions of TI information in TI data books or data sheets is permissible only if reproduction is without alteration and is accompanied by all associated warranties, conditions, limitations, and notices. TI is not responsible or liable for such altered documentation. Information of third parties may be subject to additional restrictions.

Resale of TI components or services with statements different from or beyond the parameters stated by TI for that component or service voids all express and any implied warranties for the associated TI component or service and is an unfair and deceptive business practice. TI is not responsible or liable for any such statements.

Buyer acknowledges and agrees that it is solely responsible for compliance with all legal, regulatory and safety-related requirements concerning its products, and any use of TI components in its applications, notwithstanding any applications-related information or support that may be provided by TI. Buyer represents and agrees that it has all the necessary expertise to create and implement safeguards which anticipate dangerous consequences of failures, monitor failures and their consequences, lessen the likelihood of failures that might cause harm and take appropriate remedial actions. Buyer will fully indemnify TI and its representatives against any damages arising out of the use of any TI components in safety-critical applications.

In some cases, TI components may be promoted specifically to facilitate safety-related applications. With such components, TI's goal is to help enable customers to design and create their own end-product solutions that meet applicable functional safety standards and requirements. Nonetheless, such components are subject to these terms.

No TI components are authorized for use in FDA Class III (or similar life-critical medical equipment) unless authorized officers of the parties have executed a special agreement specifically governing such use.

Only those TI components which TI has specifically designated as military grade or "enhanced plastic" are designed and intended for use in military/aerospace applications or environments. Buyer acknowledges and agrees that any military or aerospace use of TI components which have **not** been so designated is solely at the Buyer's risk, and that Buyer is solely responsible for compliance with all legal and regulatory requirements in connection with such use.

TI has specifically designated certain components as meeting ISO/TS16949 requirements, mainly for automotive use. In any case of use of non-designated products, TI will not be responsible for any failure to meet ISO/TS16949.

Products

Audio	www.ti.com/audio
Amplifiers	amplifier.ti.com
Data Converters	dataconverter.ti.com
DLP® Products	www.dlp.com
DSP	dsp.ti.com
Clocks and Timers	www.ti.com/clocks
Interface	interface.ti.com
Logic	logic.ti.com
Power Mgmt	power.ti.com
Microcontrollers	microcontroller.ti.com
RFID	www.ti-rfid.com
OMAP Applications Processors	www.ti.com/omap
Wireless Connectivity	www.ti.com/wirelessconnectivity

Applications

Automotive and Transportation	www.ti.com/automotive
Communications and Telecom	www.ti.com/communications
Computers and Peripherals	www.ti.com/computers
Consumer Electronics	www.ti.com/consumer-apps
Energy and Lighting	www.ti.com/energy
Industrial	www.ti.com/industrial
Medical	www.ti.com/medical
Security	www.ti.com/security
Space, Avionics and Defense	www.ti.com/space-avionics-defense
Video and Imaging	www.ti.com/video

TI E2E Community

e2e.ti.com