11.3-Gbps RATE-SELECTABLE LIMITING AMPLIFIER

FEATURES

- Up to 11.3-Gbps Operation
- 2-Wire Digital Interface
- Digitally Selectable Input Bandwidth
- Adjustable LOS Threshold
- Digitally Selectable Output Voltage
- Digitally Selectable Output Pre-Emphasis
- Adjustable Input Threshold Voltage
- Low Power Consumption
- Input Offset Cancellation
- CML Data Outputs with On-Chip 50-Ω Back-Termination to VCC
- Single +3.3-V Supply

- Output Disable
- Surface Mount Small Footprint 3mm × 3mm 16-Pin RoHS compliant QFN Package

APPLICATIONS

- 10-Gigabit Ethernet Optical Receivers
- 2x/4x/8x and 10x Fiber Channel Optical Receivers
- SONET OC-192/SDH-64 Optical Receivers
- SFP+ and XFP Transceiver Modules
- XENPAK, XPAK, X2 and 300-pin MSA Transponder Modules
- Cable Driver and Receiver

DESCRIPTION

The ONET8501PB is a high-speed, 3.3-V limiting amplifier for multiple fiber optic and copper cable applications with data rates from 2 Gbps up to 11.3 Gbps.

The device provides a two-wire serial interface which allows digital control of the bandwidth, output amplitude, output pre-emphasis, input threshold voltage (slice level) and the loss of signal assert level. Predetermined settings for bandwidth and LOS assert levels can also be selected with external rate selection pins.

The ONET8501PB provides a gain of about 34dB which ensures a fully differential output swing for input signals as low as 20mV_{p-p}. The output amplitude can be adjusted to 350mV_{pp}, 650mV_{pp}, or 850mV_{pp}. To compensate for frequency dependent loss of microstrips or striplines connected to the output of the device, programmable pre-emphasis is included in the output stage. A settable loss of signal detection and output disable are also provided.

The device, available in RoHS compliant small footprint 3mm × 3mm 16-pin QFN package, typically dissipates less than 170 mW and is characterized for operation from –40°C to 100°C.



Please be aware that an important notice concerning availability, standard warranty, and use in critical applications of Texas Instruments semiconductor products and disclaimers thereto appears at the end of this data sheet.



These devices have limited built-in ESD protection. The leads should be shorted together or the device placed in conductive foam during storage or handling to prevent electrostatic damage to the MOS gates.

BLOCK DIAGRAM

A simplified block diagram of the ONET8501PB is shown in Figure 1.

This compact, low power 11.3 Gbps limiting amplifier consists of a high-speed data path with offset cancellation block (DC feedback) combined with an analog settable input threshold adjust, a loss of signal detection block using 2 peak detectors, a two-wire interface with a control-logic block and a bandgap voltage reference and bias current generation block.

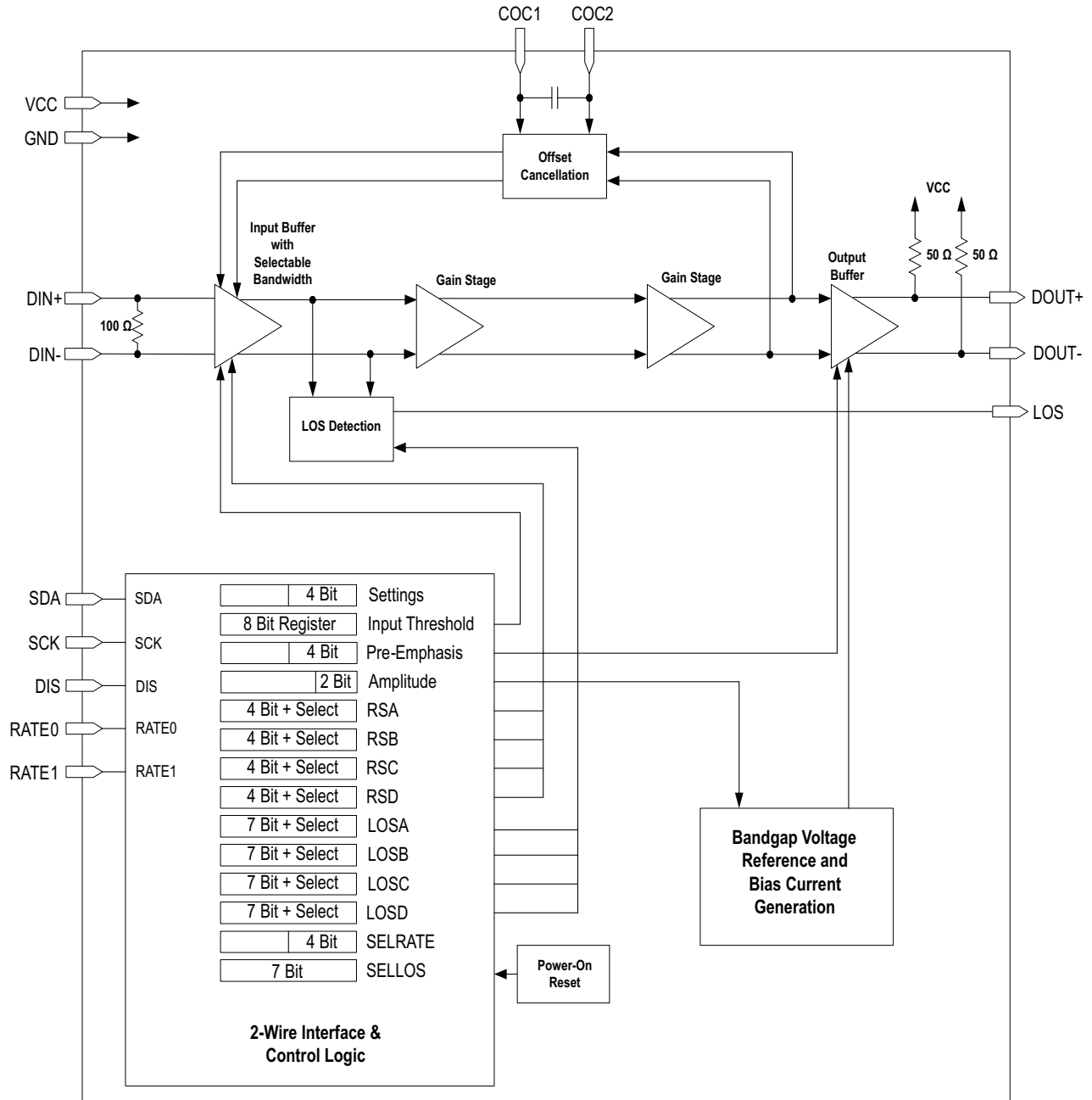

Figure 1. Simplified Block Diagram of the ONET8501PB

PACKAGE

The ONET8501PB is available in a small footprint 3mm × 3mm 16-pin RoHS compliant QFN package with a lead pitch of 0,5 mm. The pin out is shown in [Figure 2](#).

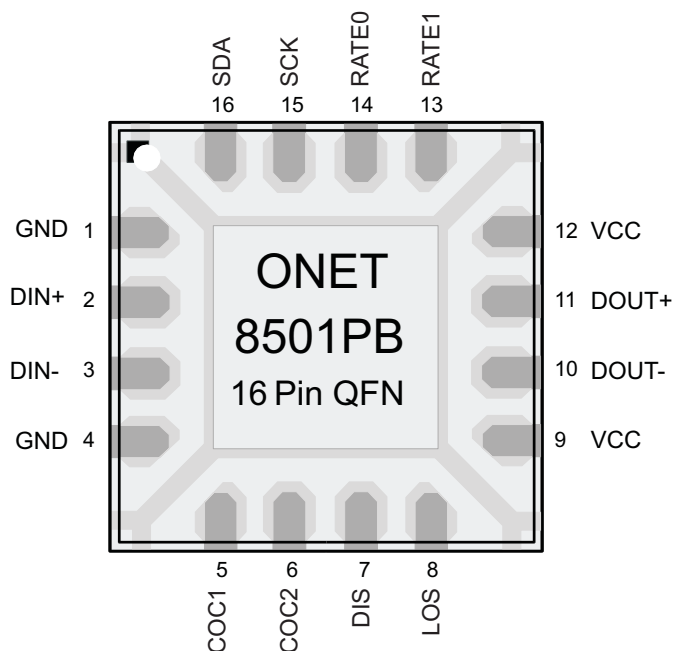

Figure 2. Pinout of ONET8501PB in a 3mm × 3mm 16-Pin QFN package (top view)

PIN DESCRIPTION

NO.	NAME	TYPE	DESCRIPTION
1,4, EP	GND	Supply	Circuit ground. Exposed die pad (EP) must be grounded.
2	DIN+	Analog-input	Non-inverted data input. Differentially 100 Ω terminated to DIN–.
3	DIN–	Analog-input	Inverted data input. Differentially 100 Ω terminated to DIN+.
5	COC1	Analog	Offset cancellation filter capacitor plus terminal. An external capacitor can be connected between this pin and COC2 to reduce the low frequency cutoff. To disable the offset cancellation loop, connect COC1 and COC2 together.
6	COC2	Analog	Offset cancellation filter capacitor minus terminal. An external capacitor can be connected between this pin and COC1 to reduce the low frequency cutoff. To disable the offset cancellation loop, connect COC1 and COC2 together.
7	DIS	Digital-input	Disables the output stage when set to a high level.
8	LOS	Open drain MOS	High level indicates that the input signal amplitude is below the programmed threshold level. Open drain output. Requires an external 10-kΩ pull-up resistor to VCC for proper operation.
9, 12	VCC	Supply	3.3-V ± 10% supply voltage.
10	DOUT–	CML-out	Inverted data output. On-chip 50 Ω back-terminated to VCC.
11	DOUT+	CML-out	Non-inverted data output. On-chip 50 Ω back-terminated to VCC.
13	RATE1	Digital-input	Bandwidth selection for noise suppression.
14	RATE0	Digital-input	Bandwidth selection for noise suppression.
15	SCK	Digital-input	Serial interface clock input. Connect a pull-up resistor (10 kΩ typical) to VCC.
16	SDA	Digital-input	Serial interface data input. Connect a pull-up resistor (10 kΩ typical) to VCC.

ABSOLUTE MAXIMUM RATINGS⁽¹⁾

over operating free-air temperature range (unless otherwise noted)

		VALUE	UNIT
V_{CC}	Supply voltage ⁽²⁾	–0.3 to 4.0	V
V_{DIN+} , V_{DIN-}	Voltage at DIN+, DIN– ⁽²⁾	0.5 to 4.0	V
V_{LOS} , V_{COC1} , V_{COC2} , V_{DOUT+} , V_{DOUT-} , V_{DIS} , V_{RATE0} , V_{RATE1} , V_{SDA} , V_{SCK}	Voltage at LOS, COC1, COC2, DOUT+, DOUT–, DIS, RATE0, RATE1, SDA, SCK ⁽²⁾	–0.3 to 4.0	V
$V_{DIN,DIFF}$	Differential voltage between DIN+ and DIN–	±2.5	V
I_{DIN+} , I_{DIN-} , I_{DOUT+} , I_{DOUT-}	Continuous current at inputs and outputs	25	mA
ESD	ESD rating at all pins	2	kV (HBM)
$T_{J,max}$	Maximum junction temperature	125	°C
T_A	Characterized free-air operating temperature range	–40 to 100	°C
T_{STG}	Storage temperature range	–65 to 150	°C
T_{LEAD}	Lead temperature 1.6mm (1/16 inch) from case for 10 seconds	260	°C

- (1) Stresses beyond those listed under *absolute maximum ratings* may cause permanent damage to the device. These are stress ratings only, and functional operation of the device at these or any other conditions beyond those indicated under *recommended operating conditions* is not implied. Device exposure to conditions outside the Absolute Maximum Ratings ranges for an extended duration can affect device reliability.
- (2) All voltage values are with respect to network ground terminal.

RECOMMENDED OPERATING CONDITIONS

		MIN	NOM	MAX	UNIT
V_{CC}	Supply voltage	2.95	3.3	3.6	V
T_A	Operating free-air temperature	–40		100	°C
	DIGITAL input high voltage	2.0			V
	DIGITAL input low voltage			0.8	V

DC ELECTRICAL CHARACTERISTICS

Over recommended operating conditions, outputs connected to a 50-Ω load, AMP1 = 0, AMP0 = 1 (Register 3) unless otherwise noted. Typical operating condition is at $V_{CC} = 3.3$ V and $T_A = 25$ °C

PARAMETER	TEST CONDITIONS	MIN	TYP	MAX	UNIT
V_{CC}	Supply voltage	2.95	3.3	3.6	V
I_{VCC}	Supply current DIS = 0, CML currents included		50	63	mA
R_{IN}	Data input resistance Differential		100		Ω
R_{OUT}	Data output resistance Single-ended, referenced to V_{CC}		50		Ω
	LOS HIGH voltage $I_{SOURCE} = 50$ μA with 10 kΩ pull-up to V_{CC}	2.4			V
	LOS LOW voltage $I_{SINK} = 10$ mA with 10 kΩ pull-up to V_{CC}			0.4	V

AC ELECTRICAL CHARACTERISTICS

Over recommended operating conditions, outputs connected to a 50-Ω load, AMP1 = 0, AMP0 = 1 (Register 3) and maximum bandwidth unless otherwise noted. Typical operating condition is at $V_{CC} = 3.3\text{ V}$ and $T_A = +25^\circ\text{C}$

PARAMETER		TEST CONDITION	MIN	TYP	MAX	UNIT
f_{3dB-H}	–3dB bandwidth default settings	RATE1 = 1, RATE0 = 0	7.5	9.0		GHz
		RATE1 = 1, RATE0 = 1		8.4		
		RATE1 = 0, RATE0 = 1		7.6		
		RATE1 = 0, RATE0 = 0		2.4		
f_{3dB-L}	Low frequency –3dB bandwidth	With 330-pF COC capacitor		10	45	kHz
$V_{IN,MIN}$	Data input sensitivity	PRBS31 pattern at 11.3 Gbps, BER < 10^{-12}		5	9	mV _{pp}
		$V_{OD,min} \geq 0.95 \times V_{OD}$ (output limited)		20	30	
		PRBS31 pattern at 8.5 Gbps, BER < 10^{-12} , RATE1 = 1, RATE0 = 0		4		
		PRBS31 pattern at 4.25 Gbps, BER < 10^{-12} , RATE1 = 1, RATE0 = 1		4		
		PRBS31 pattern at 2.125 Gbps, BER < 10^{-12} , RATE1 = 0, RATE0 = 1		4		
SDD11	Differential input return gain	0.01 GHz < f < 3.9 GHz			–16	dB
		3.9 GHz < f < 12.1 GHz		See ⁽¹⁾		
SDD22	Differential output return gain	0.01 GHz < f < 3.9 GHz			–16	dB
		3.9 GHz < f < 12.1 GHz		See ⁽¹⁾		
SCD11	Differential to common mode conversion gain	0.01 GHz < f < 12.1 GHz			–15	dB
SCC22	Common mode output return gain	0.01 GHz < f < 7.5 GHz			–13	dB
		7.5 GHz < f < 12.1 GHz			–9	
A	Small signal gain		29	34		dB
$V_{IN,MAX}$	Data input overload		2000			mV _{pp}
DJ	Deterministic jitter at 11.3 Gbps	$V_{IN} = 15\text{ mV}_{pp}$, K28.5 pattern		3	8	pS _{pp}
		$V_{IN} = 30\text{ mV}_{pp}$, K28.5 pattern		3	10	
		$V_{IN} = 2000\text{ mV}_{pp}$, K28.5 pattern		6	15	
	Deterministic jitter at 8.5 Gbps	$V_{IN} = 30\text{ mV}_{pp}$, K28.5 pattern, RATE1 = 1, RATE0 = 0		4		pS _{pp}
	Deterministic jitter at 4.25 Gbps	$V_{IN} = 30\text{ mV}_{pp}$, K28.5 pattern, RATE1 = 1, RATE0 = 1		6		pS _{pp}
	Deterministic jitter at 2.125 Gbps	$V_{IN} = 30\text{ mV}_{pp}$, K28.5 pattern, RATE1 = 0, RATE0 = 1		8		pS _{pp}
RJ	Random jitter	$V_{IN} = 30\text{ mV}_{pp}$		1		pS _{rms}
V_{OD}	Differential data output voltage	$V_{IN} > 30\text{ mV}_{pp}$, DIS = 0, AMP1 = 0, AMP0 = 0	250	350	450	mV _{pp}
		$V_{IN} > 30\text{ mV}_{pp}$, DIS = 0, AMP1 = 0, AMP0 = 1	500	650	800	
		$V_{IN} > 30\text{ mV}_{pp}$, DIS = 0, AMP1 = 1, AMP0 = 1	650	850	1050	
		DIS = 1			5	mV _{rms}
V_{PREEM}	Output pre-emphasis step size			1		dB
t_R	Output rise time	20% to 80%, $V_{IN} > 30\text{ mV}_{pp}$		28	40	ps
t_F	Output fall time	20% to 80%, $V_{IN} > 30\text{ mV}_{pp}$		28	40	ps
CMOV	AC Common mode output voltage	PRBS31 pattern; AMP1 = 0, AMP0 = 1			7	mV _{rms}
V_{TH}	LOW LOS assert threshold range min	K28.5 pattern at 11.3 Gbps, LOSRNG = 0		15		mV _{pp}
	LOW LOS assert threshold range max	K28.5 pattern at 11.3 Gbps, LOSRNG = 0		35		
V_{TH}	HIGH LOS assert threshold range min	K28.5 pattern at 11.3 Gbps, LOSRNG = 1		35		mV _{pp}
	HIGH LOS assert threshold range max	K28.5 pattern at 11.3 Gbps, LOSRNG = 1		80		
	LOS threshold variation	Versus temperature at 11.3 Gbps		1.5		dB
		Versus supply voltage V_{CC} at 11.3 Gbps		1		dB
		Versus data rate		1.5		dB
	LOS hysteresis (electrical)	K28.5 pattern at 11.3 Gbps	2	4	6	dB
T_{LOS_AST}	LOS assert time		2.5	10	80	μs
T_{LOS_DEA}	LOS deassert time		2.5	10	80	μs

(1) Differential Return Gain given by SDD11, SDD22 = $-11.6 + 13.33 \log_{10}(f/8.25)$, f in GHz

AC ELECTRICAL CHARACTERISTICS (continued)

Over recommended operating conditions, outputs connected to a 50-Ω load, AMP1 = 0, AMP0 = 1 (Register 3) and maximum bandwidth unless otherwise noted. Typical operating condition is at $V_{CC} = 3.3\text{ V}$ and $T_A = +25^\circ\text{C}$

PARAMETER	TEST CONDITION	MIN	TYP	MAX	UNIT
T_{DIS}	Disable response time		20		ns

DETAILED DESCRIPTION

HIGH-SPEED DATA PATH

The high-speed data signal is applied to the data path by means of input signal pins DIN+ / DIN–. The data path consists of a 100Ω differential termination resistor followed by a digitally controlled bandwidth switch input buffer for rate select. The RATE1 and RATE0 pins can be used to control the bandwidth of the filter. Default bandwidth settings are used; however, these can be changed using registers 4 through 7 via the serial interface. For details regarding the rate selection, see [Table 19](#). A gain stage and an output buffer stage follow the input buffer, which together provide a gain of 34dB. The device can accept input amplitude levels from 5mV_{pp} up to 2000mV_{pp}. The amplified data output signal is available at the output pins DOUT+ / DOUT– which include on-chip 2 × 50Ω back-termination to VCC.

Offset cancellation compensates for internal offset voltages and thus ensures proper operation even for very small input data signals. The offset cancellation can be disabled so that the input threshold voltage can be adjusted to optimize the bit error rate or change the eye crossing to compensate for input signal pulse width distortion. The offset cancellation can be disabled by setting OCDIS = 1 (bit 1 of register 0). The input threshold level can be adjusted using register settings THADJ[0..7] (register 1). For details regarding input threshold adjust, see [Table 19](#).

The low frequency cutoff is as low as 80kHz with the built-in filter capacitor. For applications, which require even lower cutoff frequencies, an additional external filter capacitor may be connected to the COC1 and COC2 pins. A value of 330pF results in a low frequency cutoff of 10kHz.

BANDGAP VOLTAGE AND BIAS GENERATION

The ONET8501PB limiting amplifier is supplied by a single +3.3-V supply voltage connected to the VCC pins. This voltage is referred to ground (GND).

On-chip bandgap voltage circuitry generates a reference voltage, independent of supply voltage, from which all other internally required voltages and bias currents are derived.

HIGH-SPEED OUTPUT BUFFER

The output amplitude of the buffer can be set to 350 mV_{pp}, 650 mV_{pp} or 850 mV_{pp} using register settings AMP[0..1] (register 3) via the serial interface. To compensate for frequency dependant losses of transmission lines connected to the output, the ONET8501PB has adjustable pre-emphasis of the output stage. The pre-emphasis can be set from 0 to 8 dB in 1 dB steps using register settings PEADJ[0..3] (register 2).

RATE SELECT

There are 16 possible internal filter settings (4 bit) to adjust the small signal bandwidth to the data rate. For fast rate selection, 4 default values can be selected with the RATE1 and RATE0 pins. Using the serial interface, the bandwidth settings can be customized instead of using the default values. The default bandwidths and the registers used to change the bandwidth settings are shown in [Table 1](#).

Table 1. Rate Selection Default Settings and Registers Used for Adjustment

RATE1	RATE0	DEFAULT BANDWIDTH (GHz)	REGISTER USED FOR ADJUSTMENT
0	0	2.4	RSA (Register 4)
0	1	7.6	RSB (Register 5)
1	1	8.4	RSC (Register 6)
1	0	9.0	RSD (Register 7)

If the rate select register selection bit is set LOW, for example RSASEL = 0 (bit 7 of register 4), then the default bandwidth for that register is used. If the register selection bit is set HIGH, for example RSASEL = 1 (bit 7 of register 4), then the content of RSA[0..3] (register 4) is used to set the input filter bandwidth when RATE0 = 0 and RATE1 = 0. The settings of the rate selection registers RSA, RSB, RSC and RSD and the corresponding filter bandwidths are shown in [Table 2](#).

Table 2. Available Bandwidth Settings

RSX3	RSX2	RSX1	RSX0	TYPICAL BANDWIDTH (GHz)
0	0	0	0	9.0
0	0	0	1	8.6
0	0	1	0	8.4
0	0	1	1	8.1
0	1	0	0	7.9
0	1	0	1	7.6
0	1	1	0	6.9
0	1	1	1	6.2
1	0	0	0	5.2
1	0	0	1	4.2
1	0	1	0	3.7
1	0	1	1	3.4
1	1	0	0	3.2
1	1	0	1	2.8
1	1	1	0	2.6
1	1	1	1	2.4

The RATE1 and RATE0 pins do not have to be used if the serial interface is being used. If RATE1 is not connected it is internally pulled HIGH and if RATE0 is not connected it is internally pulled LOW, thus selecting register 7. Therefore, changing the contents of RSD[0..3] (register 7) through the serial interface can be used to adjust the bandwidth.

LOSS OF SIGNAL DETECTION

The loss of signal detection is done by 2 separate level detectors to cover a wide dynamic range. The peak values of the input signal and the output signal of the gain stage are monitored by the peak detectors. The peak values are compared to a pre-defined loss of signal threshold voltage inside the loss of signal detection block. As a result of the comparison, the LOS signal, which indicates that the input signal amplitude is below the defined threshold level, is generated. The LOS assert level is settable through the serial interface. There are 2 LOS ranges settable with the LOSRNG bit (bit 2 register 0) via the serial interface. By setting the bit LOSRNG = 1, the high range of the LOS assert values are used (35mV_{PP} to 80mV_{PP}) and by setting the bit LOSRNG = 0, the low range of the LOS assert values are used (15mV_{PP} to 35mV_{PP}).

There are 128 possible internal LOS settings (7 bit) for each LOS range to adjust the LOS assert level. For fast LOS selection, 4 default values can be selected with the RATE1 and RATE0 pins; however, the LOS settings can be customized instead of using the default values. The default LOS assert levels and the registers used to change the LOS settings are shown in [Table 3](#).

Table 3. LOS Assert Level Default Settings and Registers Used for Adjustment

RATE1	RATE0	DEFAULT LOS ASSERT LEVEL (mV _{PP})	REGISTER USED FOR ADJUSTMENT
0	0	15	LOSA (Register 8)
0	1	18	LOSB (Register 9)
1	1	26	LOSC (Register 10)
1	0	26	LOSD (Register 11)

If the LOS register selection bit is set low, for example LOSASEL = 0 (bit 7 of register 8), then the default LOS assert level for that register is used. If the register selection bit is set high, for example LOSASEL = 1 (bit 7 of register 8), then the content of LOSA[0..6] (register 8) is used to set the LOS assert level when RATE1 = 0 and RATE0 = 0. The RATE1 and RATE0 pins do not have to be used if the serial interface is being used. If RATE1 is not connected it is internally pulled HIGH and if RATE0 is not connected it is internally pulled LOW, thus selecting register 11. Therefore, changing the content of LOSD[0..6] (register 11) through the serial interface can be used to adjust the LOS assert level.

2-WIRE INTERFACE AND CONTROL LOGIC

The ONET8501PB uses a 2-wire serial interface for digital control. The two circuit inputs, SDA and SCK, are driven, respectively, by the serial data and serial clock from a microcontroller, for example. Both inputs include 100-k Ω pull-up resistors to VCC. For driving these inputs, an open drain output is recommended.

The 2-wire interface allows write access to the internal memory map to modify control registers and read access to read out control and status signals. The ONET8501PB is a slave device only which means that it can not initiate a transmission itself; it always relies on the availability of the SCK signal for the duration of the transmission. The master device provides the clock signal as well as the START and STOP commands. The protocol for a data transmission is as follows:

1. START command
2. 7-bit slave address (1000100) followed by an eighth bit which is the data direction bit (R/W). A zero indicates a WRITE and a 1 indicates a READ.
3. 8-bit register address
4. 8-bit register data word
5. STOP command

Regarding timing, the ONET8501PB is I²C compatible. The typical timing is shown in [Figure 3](#) and a complete data transfer is shown in [Figure 4](#). Parameters for [Figure 3](#) are defined in [Table 4](#).

Bus Idle: Both SDA and SCK lines remain HIGH

Start Data Transfer: A change in the state of the SDA line, from HIGH to LOW, while the SCK line is HIGH, defines a START condition (S). Each data transfer begins with a START condition.

Stop Data Transfer: A change in the state of the SDA line from LOW to HIGH while the SCK line is HIGH defines a STOP condition (P). Each data transfer ends with a STOP condition; however, if the master still wishes to communicate on the bus, it can generate a repeated START condition and address another slave without first generating a STOP condition.

Data Transfer: Only one data byte can be transferred between a START and a STOP condition. The receiver acknowledges the transfer of data.

Acknowledge: Each receiving device, when addressed, is obliged to generate an acknowledge bit. The transmitter releases the SDA line and a device that acknowledges must pull down the SDA line during the acknowledge clock pulse in such a way that the SDA line is stable LOW during the HIGH period of the acknowledge clock pulse. Setup and hold times must be taken into account. When a slave-receiver doesn't acknowledge the slave address, the data line must be left HIGH by the slave. The master can then generate a STOP condition to abort the transfer. If the slave-receiver does acknowledge the slave address but some time later in the transfer cannot receive any more data bytes, the master must abort the transfer. This is indicated by the slave generating the not acknowledge on the first byte to follow. The slave leaves the data line HIGH and the master generates the STOP condition.

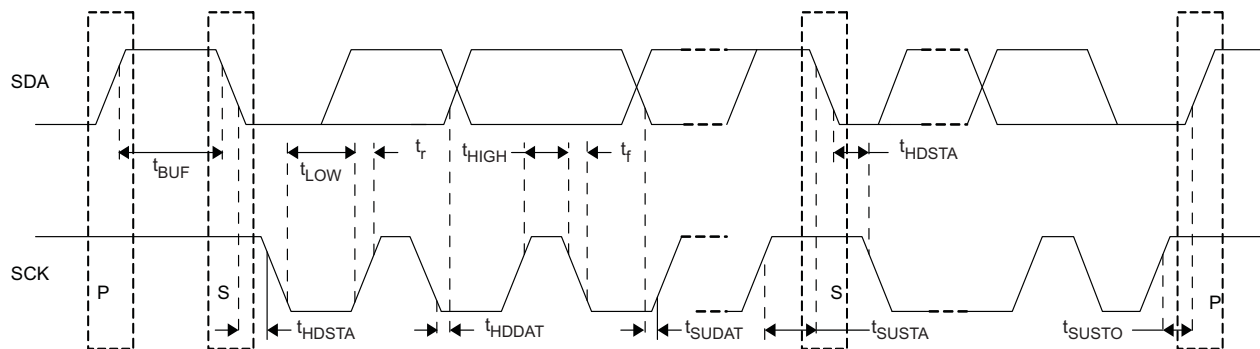

Figure 3. I²C Timing Diagram

Table 4. Timing Diagram Definitions

PARAMETER		MIN	MAX	UNIT
f_{SCK}	SCK clock frequency		400	kHz
t_{BUF}	Bus free time between START and STOP conditions	1.3		μ s
t_{HDSTA}	Hold time after repeated START condition. After this period, the first clock pulse is generated	0.6		μ s
t_{LOW}	Low period of the SCK clock	1.3		μ s
t_{HIGH}	High period of the SCK clock	0.6		μ s
t_{SUSTA}	Setup time for a repeated START condition	0.6		μ s
t_{HDDAT}	Data HOLD time	0		μ s
t_{SUDAT}	Data setup time	100		ns
t_r	Rise time of both SDA and SCK signals		300	ns
t_f	Fall time of both SDA and SCK signals		300	ns
t_{SUSTO}	Setup time for STOP condition	0.6		μ s

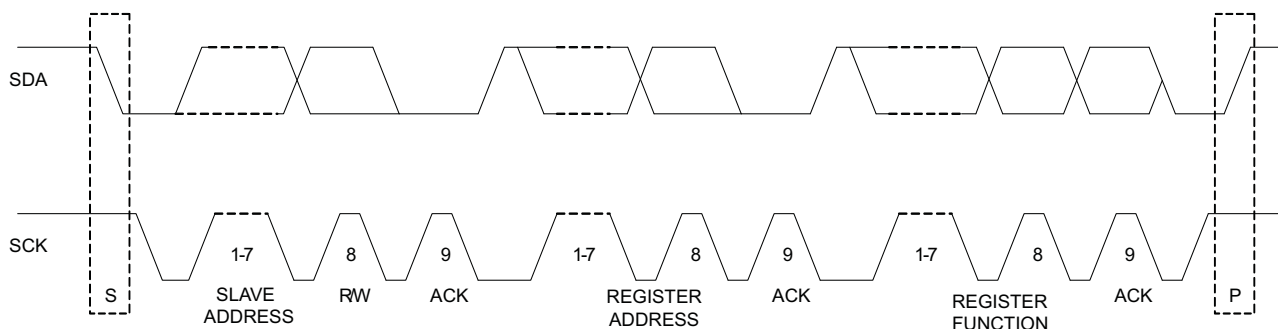

Figure 4. I²C Data Transfer

REGISTER MAPPING

The register mapping for read/write register addresses 0 (0x00) through 11 (0x0B) are shown in [Table 5](#) through [Table 16](#). The register mapping for the read only register addresses 14 (0x0E) and 15 (0x0F) are shown in [Table 17](#) and [Table 18](#).

[Table 19](#) describes the circuit functionality based on the register settings.

Table 5. Register 0 (0x00) Mapping – Control Settings

register address 0 (0x00)							
bit 7	bit 6	bit 5	bit4	bit 3	bit 2	bit 1	bit 0
–	–	–	–	DIS	LOSRNG	OCDIS	I2CDIS

Table 6. Register 1 (0x01) Mapping – Input Threshold Adjust

register address 1 (0x01)							
bit 7	bit 6	bit 5	bit4	bit 3	bit 2	bit 1	bit 0
THADJ7	THADJ6	THADJ5	THADJ4	THADJ3	THADJ2	THADJ1	THADJ0

Table 7. Register 2 (0x02) Mapping – Pre-emphasis Adjust

register address 2 (0x02)							
bit 7	bit 6	bit 5	bit4	bit 3	bit 2	bit 1	bit 0
–	–	–	–	PEADJ3	PEADJ2	PEADJ1	PEADJ0

Table 8. Register 3 (0x03) Mapping – Output Amplitude Adjust

register address 3 (0x03)							
bit 7	bit 6	bit 5	bit4	bit 3	bit 2	bit 1	bit 0
–	–	–	–	–	–	AMP1	AMP0

Table 9. Register 4 (0x04) Mapping – Rate Selection Register A

register address 4 (0x04)							
bit 7	bit 6	bit 5	bit4	bit 3	bit 2	bit 1	bit 0
RSASEL	–	–	–	RSA3	RSA2	RSA1	RSA0

Table 10. Register 5 (0x05) Mapping – Rate Selection Register B

register address 5 (0x05)							
bit 7	bit 6	bit 5	bit4	bit 3	bit 2	bit 1	bit 0
RSBSEL	–	–	–	RSB3	RSB2	RSB1	RSB0

Table 11. Register 6 (0x06) Mapping – Rate Selection Register C

register address 6 (0x06)							
bit 7	bit 6	bit 5	bit4	bit 3	bit 2	bit 1	bit 0
RSCSEL	–	–	–	RSC3	RSC2	RSC1	RSC0

Table 12. Register 7 (0x07) Mapping – Rate Selection Register D

register address 7 (0x07)							
bit 7	bit 6	bit 5	bit4	bit 3	bit 2	bit 1	bit 0
RSDSEL	–	–	–	RSD3	RSD2	RSD1	RSD0

Table 13. Register 8 (0x08) Mapping – LOS Assert Level Register A

register address 8 (0x08)							
bit 7	bit 6	bit 5	bit4	bit 3	bit 2	bit 1	bit 0
LOSASEL	LOSA6	LOSA5	LOSA4	LOSA3	LOSA2	LOSA1	LOSA0

Table 14. Register 9 (0x09) Mapping – LOS Assert Level Register B

register address 9 (0x09)							
bit 7	bit 6	bit 5	bit4	bit 3	bit 2	bit 1	bit 0
LOSBSSEL	LOSB6	LOSB5	LOSB4	LOSB3	LOSB2	LOSB1	LOSB0

Table 15. Register 10 (0x0A) Mapping – LOS Assert Level Register C

register address 10 (0x0A)							
bit 7	bit 6	bit 5	bit4	bit 3	bit 2	bit 1	bit 0
LOSCSEL	LOSC6	LOSC5	LOSC4	LOSC3	LOSC2	LOSC1	LOSC0

Table 16. Register 11 (0x0B) Mapping – LOS Assert Level Register D

register address 11 (0x0B)							
bit 7	bit 6	bit 5	bit4	bit 3	bit 2	bit 1	bit 0
LOSDSEL	LOSD6	LOSD5	LOSD4	LOSD3	LOSD2	LOSD1	LOSD0

Table 17. Register 14 (0x0E) Mapping – Selected Rate Setting (Read Only)

register address 14 (0x0E)							
bit 7	bit 6	bit 5	bit4	bit 3	bit 2	bit 1	bit 0
–	–	–	–	SELRATE3	SELRATE2	SELRATE1	SELRATE0

Table 18. Register 15 (0x0F) Mapping – Selected LOS Level (Read Only)

register address 15 (0x0F)							
bit 7	bit 6	bit 5	bit4	bit 3	bit 2	bit 1	bit 0
–	SELLOS6	SELLOS5	SELLOS4	SELLOS3	SELLOS2	SELLOS1	SELLOS0

Table 19. Register Functionality

SYMBOL	REGISTER BIT	FUNCTION
DIS	Output disable bit 3	Output disable bit: 1 = output disabled 0 = output enabled
LOSRNG	LOS Range bit 2	LOS range bit: 1 = high LOS assert voltage range 0 = low LOS assert voltage range
OCDIS	Offset cancellation disable bit 1	Offset cancellation disable bit: 1 = offset cancellation is disabled 0 = offset cancellation is enabled
I2CDIS	I ² C disable bit 0	I²C disable bit: 1 = I ² C is disabled. 0 = I ² C is enabled. This is the default setting.

Table 19. Register Functionality (continued)

SYMBOL	REGISTER BIT	FUNCTION																						
THADJ7	Input threshold adjust bit 7 (MSB)	Input threshold adjustment setting: Maximum positive shift for 00000001 (1) Minimum positive shift for 01111111 (127) Zero shift for 10000000 (128) Minimum negative shift for 10000001 (129) Maximum negative shift for 11111111 (255)																						
THADJ6	Input threshold adjust bit 6																							
THADJ5	Input threshold adjust bit 5																							
THADJ4	Input threshold adjust bit 4																							
THADJ3	Input threshold adjust bit 3																							
THADJ2	Input threshold adjust bit 2																							
THADJ1	Input threshold adjust bit 1																							
THADJ0	Input threshold adjust bit 0 (LSB)																							
PEADJ3	Pre-emphasis adjust bit 3 (MSB)	Pre-emphasis setting: <table border="1" style="margin-left: 20px;"> <thead> <tr> <th>Pre-emphasis (dB)</th> <th>Register Setting</th> </tr> </thead> <tbody> <tr><td>0</td><td>0000</td></tr> <tr><td>1</td><td>0001</td></tr> <tr><td>2</td><td>0011</td></tr> <tr><td>3</td><td>0100</td></tr> <tr><td>4</td><td>0101</td></tr> <tr><td>5</td><td>0111</td></tr> <tr><td>6</td><td>1100</td></tr> <tr><td>7</td><td>1101</td></tr> <tr><td>8</td><td>1111</td></tr> </tbody> </table>			Pre-emphasis (dB)	Register Setting	0	0000	1	0001	2	0011	3	0100	4	0101	5	0111	6	1100	7	1101	8	1111
Pre-emphasis (dB)	Register Setting																							
0	0000																							
1	0001																							
2	0011																							
3	0100																							
4	0101																							
5	0111																							
6	1100																							
7	1101																							
8	1111																							
PEADJ2	Pre-emphasis adjust bit 2																							
PEADJ1	Pre-emphasis adjust bit 1																							
PEADJ0	Pre-emphasis adjust bit 0 (LSB)																							
AMP1	Output amplitude adjustment bit 1	Output amplitude adjustment: 00 = 350 mV _{pp} 01 = 650 mV _{pp} 10 = 650 mV _{pp} 11 = 850 mV _{pp}																						
AMP0	Output amplitude adjustment bit 0																							
RSASEL	Register RSA select bit 7 (MSB)	Rate selection register A RSASEL = 1 Content of register A bits 3 to 0 is used to select the input filter BW RSASEL = 0 Default BW of 2.4 GHz is used Register RSA is used when RATE1 = 0 and RATE0 = 0																						
–																								
–																								
–																								
RSA3	Rate select register A bit 3																							
RSA2	Rate select register A bit 2																							
RSA1	Rate select register A bit 1																							
RSA0	Rate select register A bit 0 (LSB)																							
RSBSEL	Register RSB select bit 7 (MSB)	Rate selection register B RSBSEL = 1 Content of register B bits 3 to 0 is used to select the input filter BW RSBSEL = 0 Default BW of 7.6 GHz is used Register RSB is used when RATE1 = 0 and RATE0 = 1																						
–																								
–																								
–																								
RSB3	Rate select register B bit 3																							
RSB2	Rate select register B bit 2																							
RSB1	Rate select register B bit 1																							
RSB0	Rate select register B bit 0 (LSB)																							

Table 19. Register Functionality (continued)

SYMBOL	REGISTER BIT	FUNCTION
RSCSEL	Register RSC select bit 7 (MSB)	Rate selection register C RSCSEL = 1 Content of register C bits 3 to 0 is used to select the input filter BW RSCSEL = 0 Default BW of 8.4 GHz is used Register RSC is used when RATE1 = 1 and RATE0 = 1
–		
–		
–		
RSC3	Rate select register C bit 3	
RSC2	Rate select register C bit 2	
RSC1	Rate select register C bit 1	
RSC0	Rate select register C bit 0 (LSB)	
RSDSEL	Register RSD select bit 7 (MSB)	Rate selection register D RSDSEL = 1 Content of register D bits 3 to 0 is used to select the input filter BW RSDSEL = 0 Default BW of 9.0 GHz is used Register RSD is used when RATE1 = 1 and RATE0 = 0 or RATE1 and RATE0 are not connected
–		
–		
–		
RSD3	Rate select register D bit 3	
RSD2	Rate select register D bit 2	
RSD1	Rate select register D bit 1	
RSD0	Rate select register D bit 0 (LSB)	
LOSASEL	Register LOSA select bit 7 (MSB)	LOS assert level register A LOSASEL = 1 Content of register A bits 6 to 0 is used to select the LOS assert level Minimum LOS assert level for 0000000 Maximum LOS assert level for 1111111 LOSASEL = 0 Default LOS assert level of 15 mVpp is used Register LOSA is used when RATE1 = 0 and RATE0 = 0
LOSA6	LOS assert level register A bit 6	
LOSA5	LOS assert level register A bit 5	
LOSA4	LOS assert level register A bit 4	
LOSA3	LOS assert level register A bit 3	
LOSA2	LOS assert level register A bit 2	
LOSA1	LOS assert level register A bit 1	
LOSA0	LOS assert level register A bit 0 (LSB)	
LOSBSEL	Register LOSB select bit 7 (MSB)	LOS assert level register B LOSBSEL = 1 Content of register B bits 6 to 0 is used to select the LOS assert level Minimum LOS assert level for 0000000 Maximum LOS assert level for 1111111 LOSBSEL = 0 Default LOS assert level of 18 mVpp is used Register LOSB is used when RATE1 = 0 and RATE0 = 1
LOSB6	LOS assert level register B bit 6	
LOSB5	LOS assert level register B bit 5	
LOSB4	LOS assert level register B bit 4	
LOSB3	LOS assert level register B bit 3	
LOSB2	LOS assert level register B bit 2	
LOSB1	LOS assert level register B bit 1	
LOSB0	LOS assert level register B bit 0 (LSB)	
LOSCSEL	Register LOSC select bit 7 (MSB)	LOS assert level register C LOSCSEL = 1 Content of register C bits 6 to 0 is used to select the LOS assert level Minimum LOS assert level for 0000000 Maximum LOS assert level for 1111111 LOSCSEL = 0 Default LOS assert level of 26 mVpp is used Register LOSC is used when RATE1 = 1 and RATE0 = 1
LOSC6	LOS assert level register C bit 6	
LOSC5	LOS assert level register C bit 5	
LOSC4	LOS assert level register C bit 4	
LOSC3	LOS assert level register C bit 3	
LOSC2	LOS assert level register C bit 2	
LOSC1	LOS assert level register C bit 1	
LOSC0	LOS assert level register C bit 0 (LSB)	

Table 19. Register Functionality (continued)

SYMBOL	REGISTER BIT	FUNCTION
LODSEL	Register LOSD select bit 7 (MSB)	LOS assert level register D LODSEL = 1 Content of register D bits 6 to 0 is used to select the LOS assert level Minimum LOS assert level for 0000000 Maximum LOS assert level for 1111111 LODSEL = 0 Default LOS assert level of 26 mVpp is used Register LOSD is used when RATE1 = 1 and RATE0 = 0
LOSD6	LOS assert level register D bit 6	
LOSD5	LOS assert level register D bit 5	
LOSD4	LOS assert level register D bit 4	
LOSD3	LOS assert level register D bit 3	
LOSD2	LOS assert level register D bit 2	
LOSD1	LOS assert level register D bit 1	
LOSD0	LOS assert level register D bit 0 (LSB)	
SELRATE3	Selected rate setting bit 3	Selected rate setting (read only)
SELRATE2	Selected rate setting bit 2	
SELRATE1	Selected rate setting bit 1	
SELRATE0	Selected rate setting bit 0	
SELLOS6	Selected LOS assert level bit 6 (MSB)	Selected LOS assert level (read only)
SELLOS5	Selected LOS assert level bit 5	
SELLOS4	Selected LOS assert level bit 4	
SELLOS3	Selected LOS assert level bit 3	
SELLOS2	Selected LOS assert level bit 2	
SELLOS1	Selected LOS assert level bit 1	
SELLOS0	Selected LOS assert level bit 0 (LSB)	

TYPICAL OPERATION CHARACTERISTICS

Typical operating condition is at $V_{CC} = 3.3\text{ V}$, $T_A = 25^\circ\text{C}$, AMP1 = 0, AMP0 = 1 (Register 3) and maximum bandwidth unless otherwise noted.

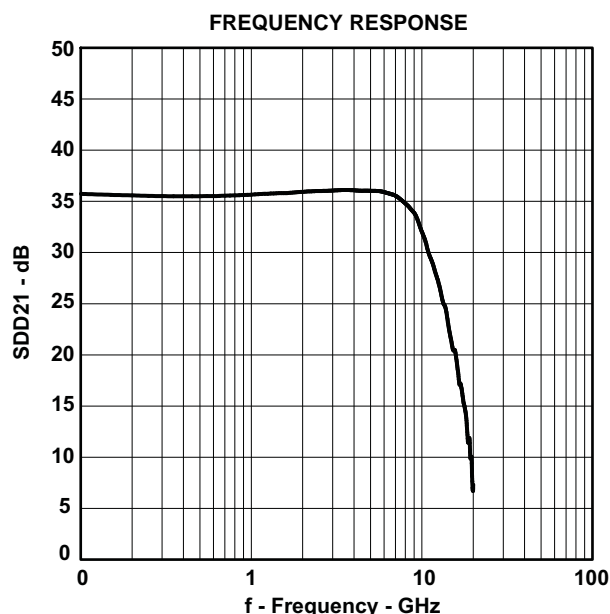

Figure 5.

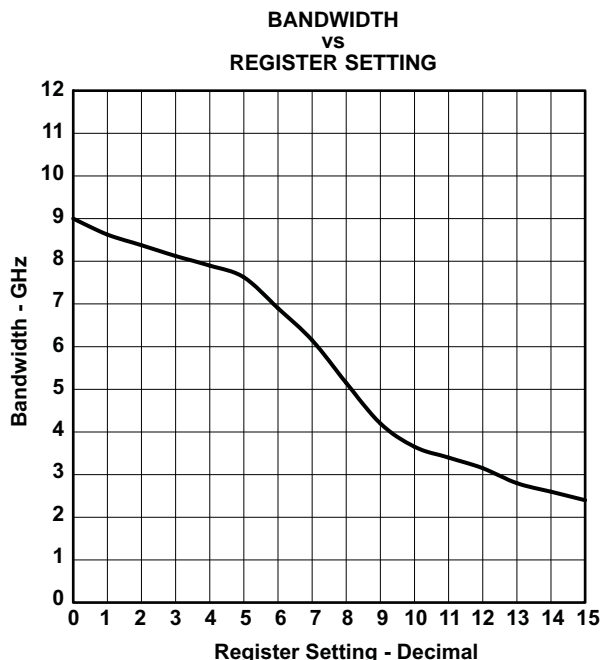

Figure 6.

TYPICAL OPERATION CHARACTERISTICS (continued)

Typical operating condition is at $V_{CC} = 3.3\text{ V}$, $T_A = 25^\circ\text{C}$, AMP1 = 0, AMP0 = 1 (Register 3) and maximum bandwidth unless otherwise noted.

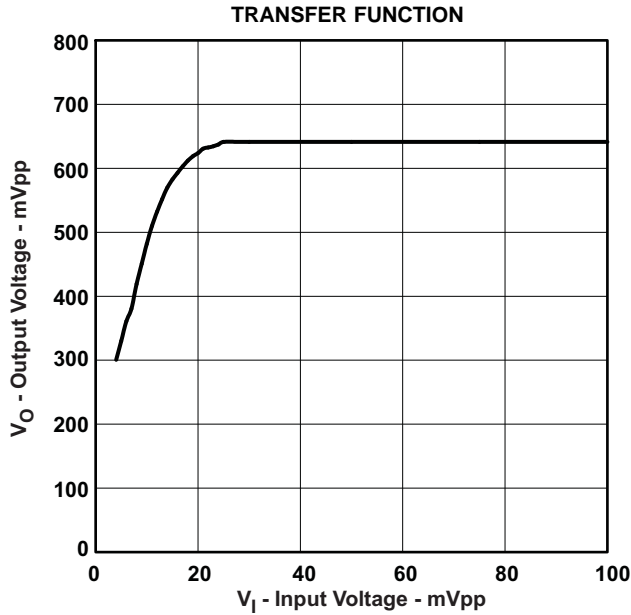

Figure 7.

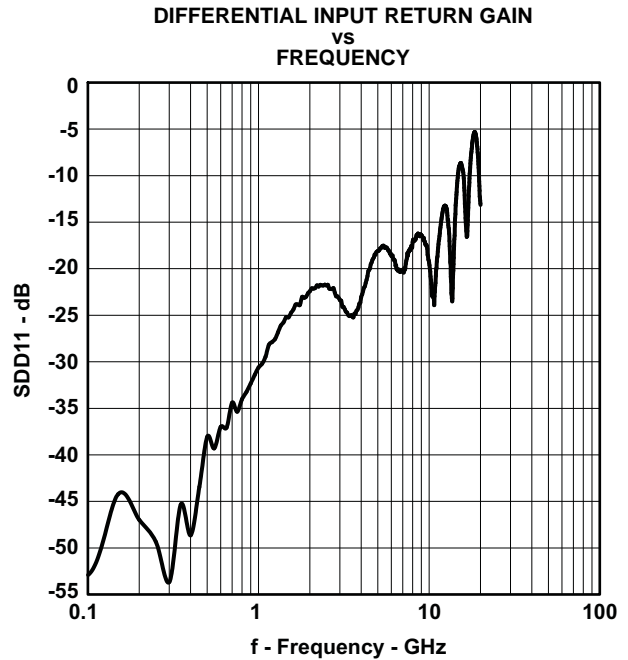

Figure 8.

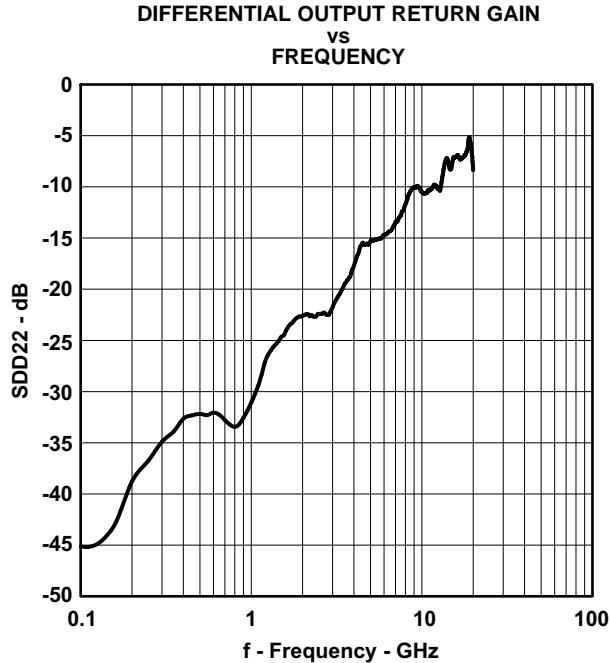

Figure 9.

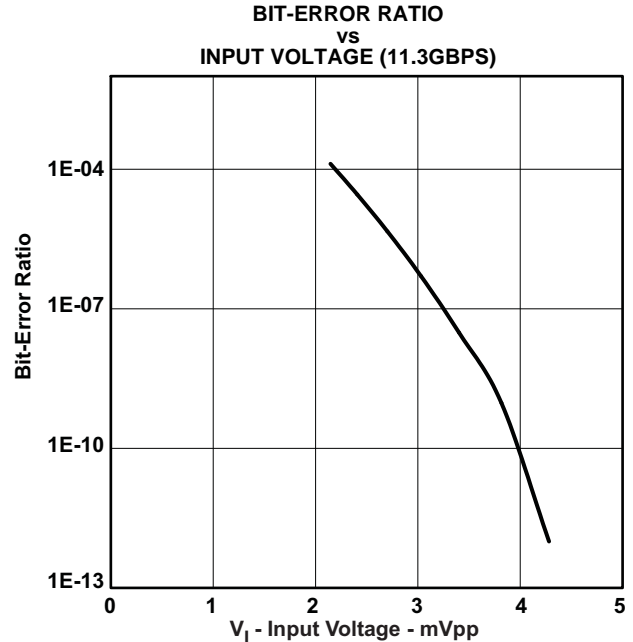

Figure 10.

TYPICAL OPERATION CHARACTERISTICS (continued)

Typical operating condition is at $V_{CC} = 3.3\text{ V}$, $T_A = 25^\circ\text{C}$, AMP1 = 0, AMP0 = 1 (Register 3) and maximum bandwidth unless otherwise noted.

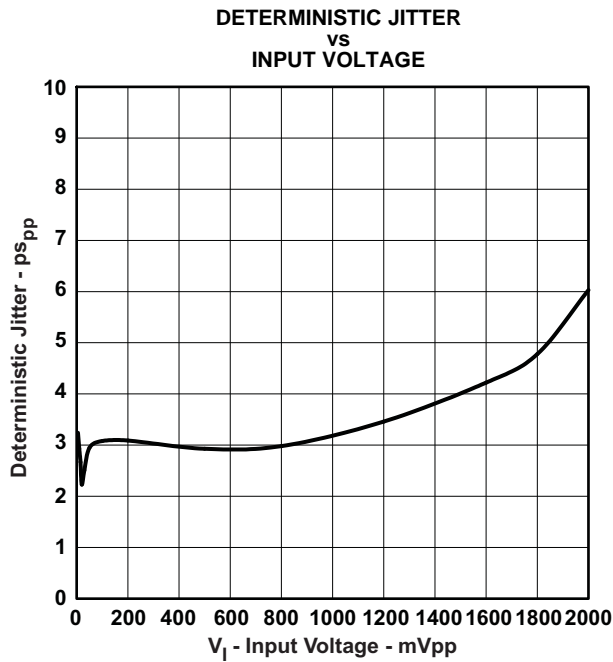

Figure 11.

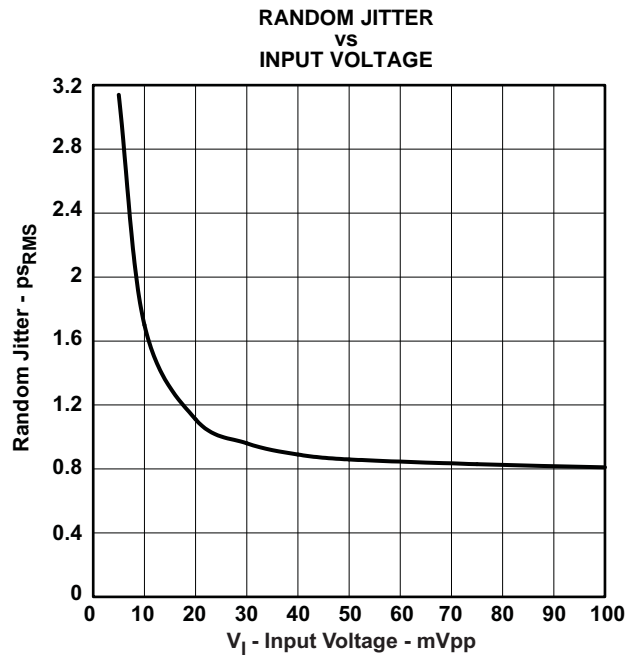

Figure 12.

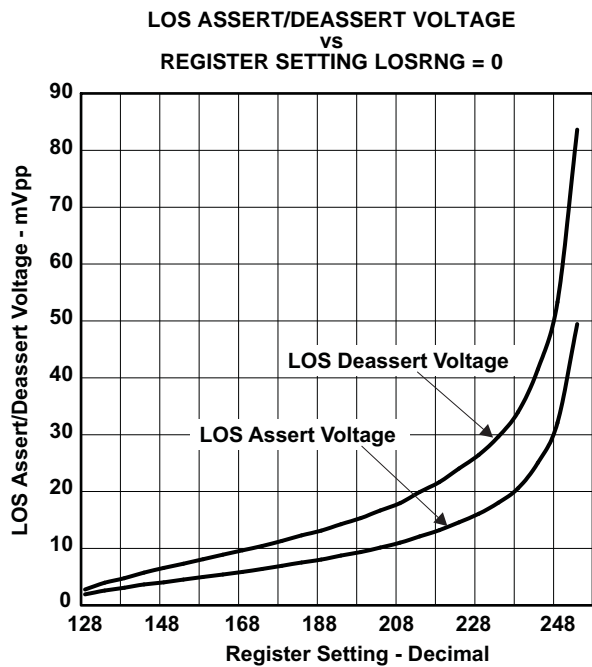

Figure 13.

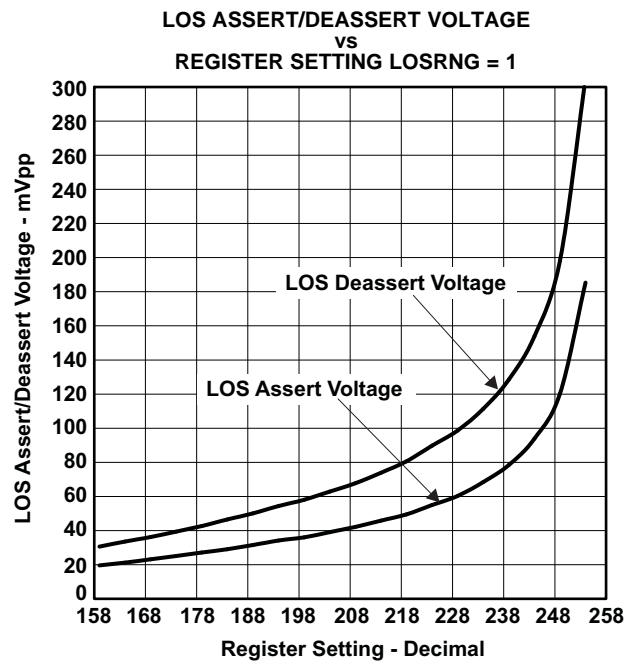

Figure 14.

TYPICAL OPERATION CHARACTERISTICS (continued)

Typical operating condition is at $V_{CC} = 3.3\text{ V}$, $T_A = 25^\circ\text{C}$, AMP1 = 0, AMP0 = 1 (Register 3) and maximum bandwidth unless otherwise noted.

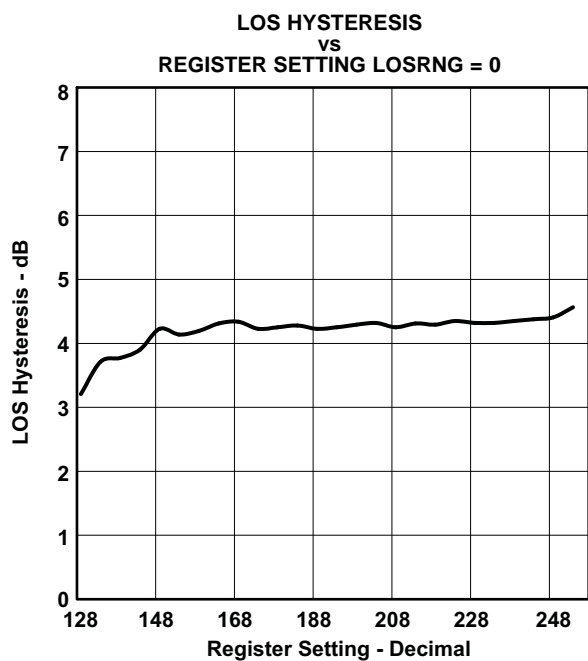

Figure 15.

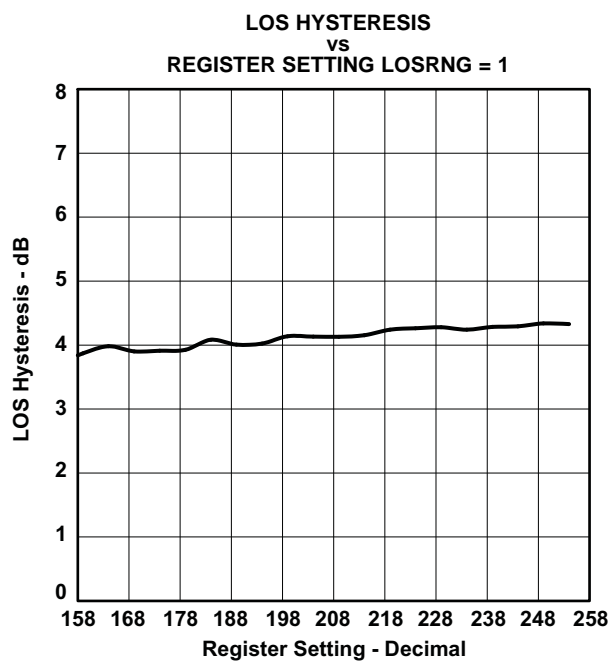

Figure 16.

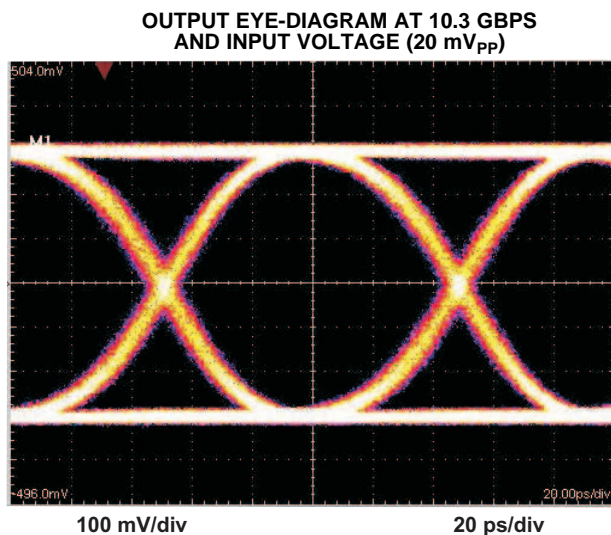

Figure 17.

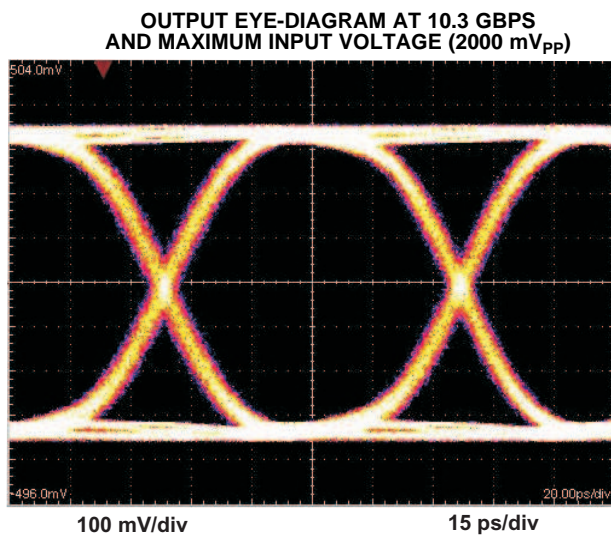

Figure 18.

TYPICAL OPERATION CHARACTERISTICS (continued)

Typical operating condition is at $V_{CC} = 3.3\text{ V}$, $T_A = 25^\circ\text{C}$, AMP1 = 0, AMP0 = 1 (Register 3) and maximum bandwidth unless otherwise noted.

**OUTPUT EYE-DIAGRAM AT 8.5 GBPS
AND INPUT VOLTAGE (20 mV_{PP})**

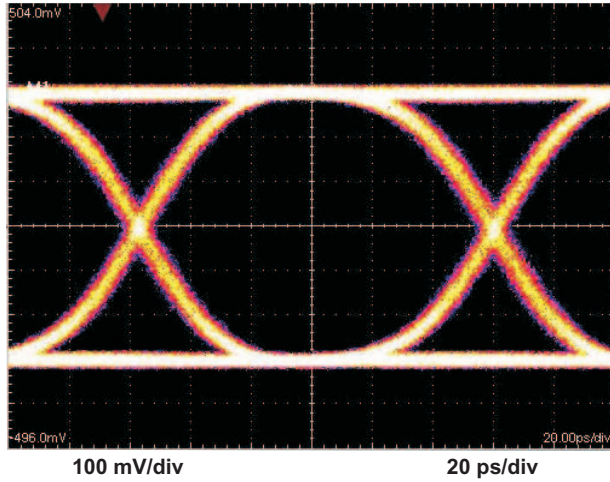

Figure 19.

**OUTPUT EYE-DIAGRAM AT 8.5 GBPS
AND MAXIMUM INPUT VOLTAGE (2000 mV_{PP})**

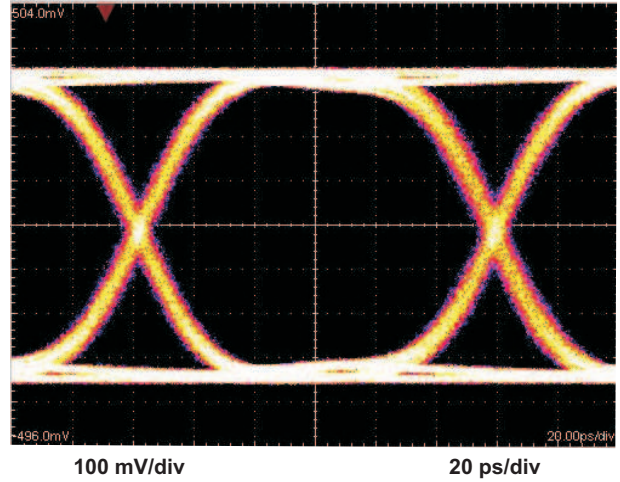

Figure 20.

APPLICATION INFORMATION

Figure 21 shows a typical application circuit using the ONET8501PB.

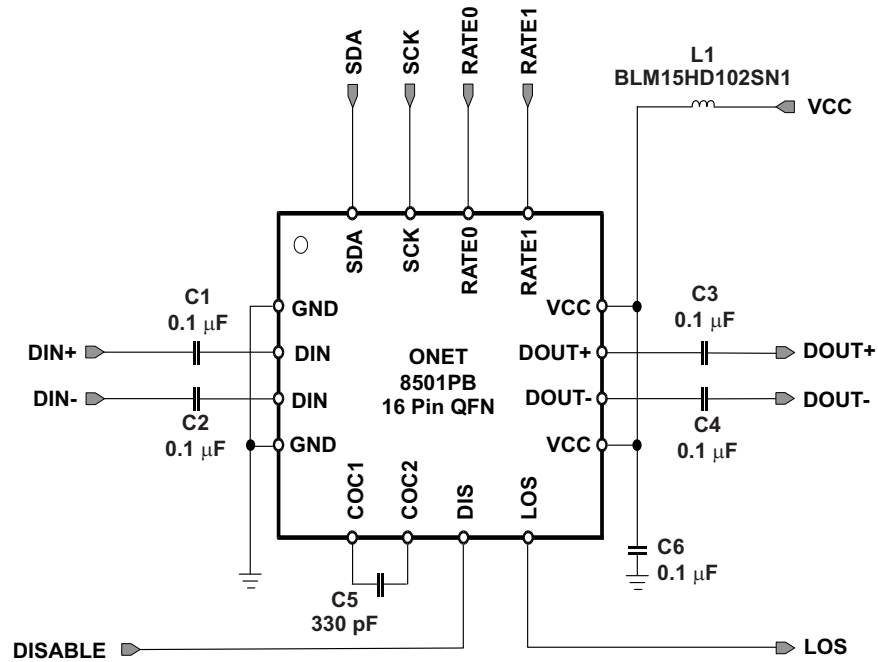

Figure 21. Typical Application Circuit

PACKAGING INFORMATION

Orderable Device	Status (1)	Package Type	Package Drawing	Pins	Package Qty	Eco Plan (2)	Lead/Ball Finish	MSL Peak Temp (3)	Op Temp (°C)	Top-Side Markings (4)	Samples
ONET8501PBRGTR	ACTIVE	QFN	RGT	16	3000	Green (RoHS & no Sb/Br)	CU NIPDAU	Level-2-260C-1 YEAR	-40 to 100	85PB	Samples
ONET8501PBRGTRG4	ACTIVE	QFN	RGT	16	3000	Green (RoHS & no Sb/Br)	CU NIPDAU	Level-2-260C-1 YEAR	-40 to 100	85PB	Samples
ONET8501PBRGTT	ACTIVE	QFN	RGT	16	250	Green (RoHS & no Sb/Br)	CU NIPDAU	Level-2-260C-1 YEAR	-40 to 100	85PB	Samples
ONET8501PBRGTTG4	ACTIVE	QFN	RGT	16	250	Green (RoHS & no Sb/Br)	CU NIPDAU	Level-2-260C-1 YEAR	-40 to 100	85PB	Samples

(1) The marketing status values are defined as follows:

ACTIVE: Product device recommended for new designs.

LIFEBUY: TI has announced that the device will be discontinued, and a lifetime-buy period is in effect.

NRND: Not recommended for new designs. Device is in production to support existing customers, but TI does not recommend using this part in a new design.

PREVIEW: Device has been announced but is not in production. Samples may or may not be available.

OBSOLETE: TI has discontinued the production of the device.

(2) Eco Plan - The planned eco-friendly classification: Pb-Free (RoHS), Pb-Free (RoHS Exempt), or Green (RoHS & no Sb/Br) - please check <http://www.ti.com/productcontent> for the latest availability information and additional product content details.

TBD: The Pb-Free/Green conversion plan has not been defined.

Pb-Free (RoHS): TI's terms "Lead-Free" or "Pb-Free" mean semiconductor products that are compatible with the current RoHS requirements for all 6 substances, including the requirement that lead not exceed 0.1% by weight in homogeneous materials. Where designed to be soldered at high temperatures, TI Pb-Free products are suitable for use in specified lead-free processes.

Pb-Free (RoHS Exempt): This component has a RoHS exemption for either 1) lead-based flip-chip solder bumps used between the die and package, or 2) lead-based die adhesive used between the die and leadframe. The component is otherwise considered Pb-Free (RoHS compatible) as defined above.

Green (RoHS & no Sb/Br): TI defines "Green" to mean Pb-Free (RoHS compatible), and free of Bromine (Br) and Antimony (Sb) based flame retardants (Br or Sb do not exceed 0.1% by weight in homogeneous material)

(3) MSL, Peak Temp. -- The Moisture Sensitivity Level rating according to the JEDEC industry standard classifications, and peak solder temperature.

(4) Multiple Top-Side Markings will be inside parentheses. Only one Top-Side Marking contained in parentheses and separated by a "~" will appear on a device. If a line is indented then it is a continuation of the previous line and the two combined represent the entire Top-Side Marking for that device.

Important Information and Disclaimer: The information provided on this page represents TI's knowledge and belief as of the date that it is provided. TI bases its knowledge and belief on information provided by third parties, and makes no representation or warranty as to the accuracy of such information. Efforts are underway to better integrate information from third parties. TI has taken and continues to take reasonable steps to provide representative and accurate information but may not have conducted destructive testing or chemical analysis on incoming materials and chemicals. TI and TI suppliers consider certain information to be proprietary, and thus CAS numbers and other limited information may not be available for release.

In no event shall TI's liability arising out of such information exceed the total purchase price of the TI part(s) at issue in this document sold by TI to Customer on an annual basis.

TAPE AND REEL INFORMATION

QUADRANT ASSIGNMENTS FOR PIN 1 ORIENTATION IN TAPE

*All dimensions are nominal

Device	Package Type	Package Drawing	Pins	SPQ	Reel Diameter (mm)	Reel Width W1 (mm)	A0 (mm)	B0 (mm)	K0 (mm)	P1 (mm)	W (mm)	Pin1 Quadrant
ONET8501PBRGTR	QFN	RGT	16	3000	330.0	12.4	3.3	3.3	1.1	8.0	12.0	Q2
ONET8501PBRGTT	QFN	RGT	16	250	180.0	12.4	3.3	3.3	1.1	8.0	12.0	Q2
ONET8501PBRGTT	QFN	RGT	16	250	180.0	12.4	3.3	3.3	1.1	8.0	12.0	Q2

TAPE AND REEL BOX DIMENSIONS

*All dimensions are nominal

Device	Package Type	Package Drawing	Pins	SPQ	Length (mm)	Width (mm)	Height (mm)
ONET8501PBRGTR	QFN	RGT	16	3000	367.0	367.0	35.0
ONET8501PBRGTT	QFN	RGT	16	250	338.1	338.1	20.6
ONET8501PBRGTT	QFN	RGT	16	250	210.0	185.0	35.0

RGT (S-PVQFN-N16)

PLASTIC QUAD FLATPACK NO-LEAD

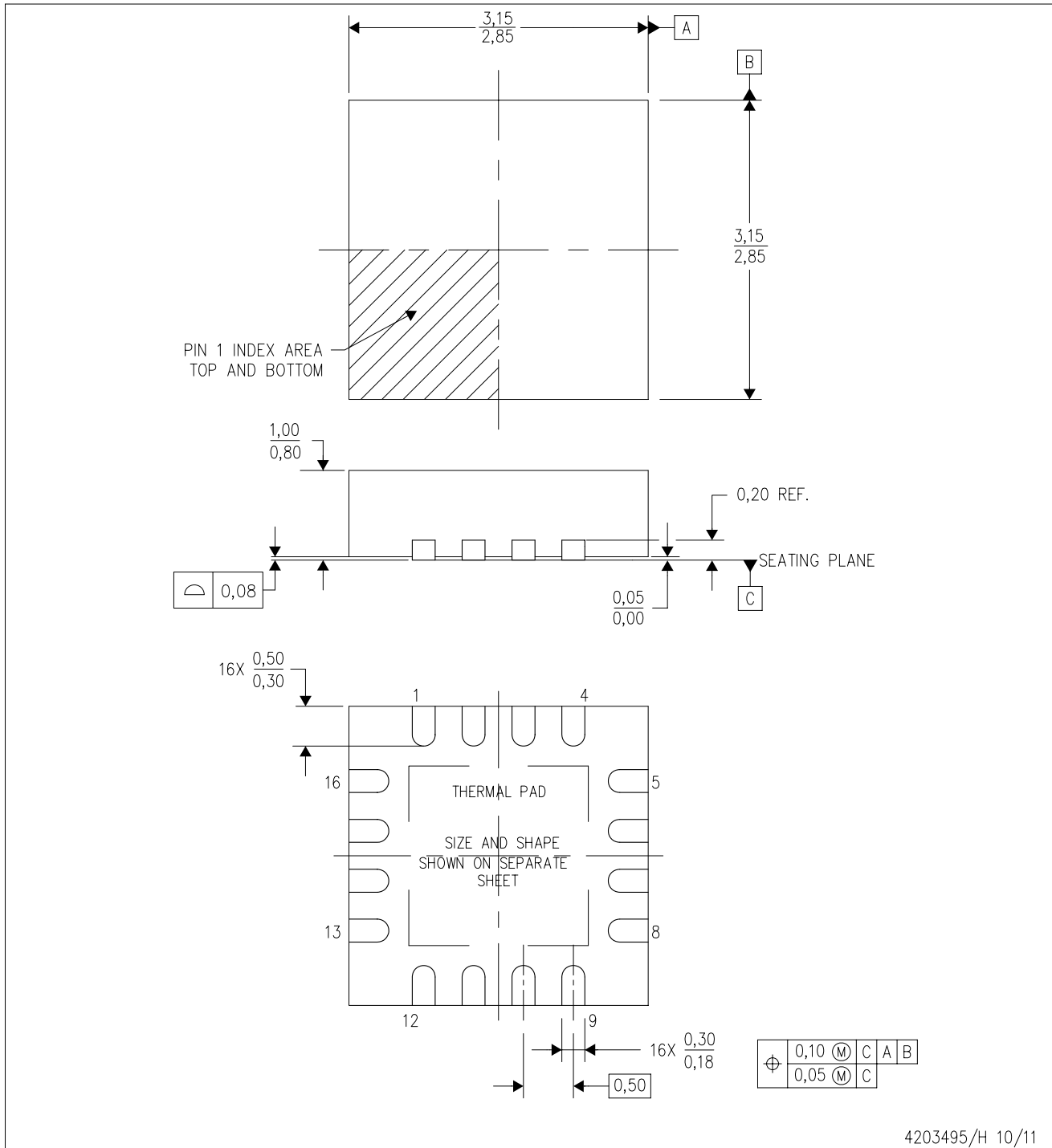

4203495/H 10/11

- NOTES:
- All linear dimensions are in millimeters. Dimensioning and tolerancing per ASME Y14.5M-1994.
 - This drawing is subject to change without notice.
 - Quad Flatpack, No-leads (QFN) package configuration.
 - The package thermal pad must be soldered to the board for thermal and mechanical performance.
 - See the additional figure in the Product Data Sheet for details regarding the exposed thermal pad features and dimensions.
 - Falls within JEDEC MO-220.

THERMAL PAD MECHANICAL DATA

RGT (S-PVQFN-N16)

PLASTIC QUAD FLATPACK NO-LEAD

THERMAL INFORMATION

This package incorporates an exposed thermal pad that is designed to be attached directly to an external heatsink. The thermal pad must be soldered directly to the printed circuit board (PCB). After soldering, the PCB can be used as a heatsink. In addition, through the use of thermal vias, the thermal pad can be attached directly to the appropriate copper plane shown in the electrical schematic for the device, or alternatively, can be attached to a special heatsink structure designed into the PCB. This design optimizes the heat transfer from the integrated circuit (IC).

For information on the Quad Flatpack No-Lead (QFN) package and its advantages, refer to Application Report, QFN/SON PCB Attachment, Texas Instruments Literature No. SLUA271. This document is available at www.ti.com.

The exposed thermal pad dimensions for this package are shown in the following illustration.

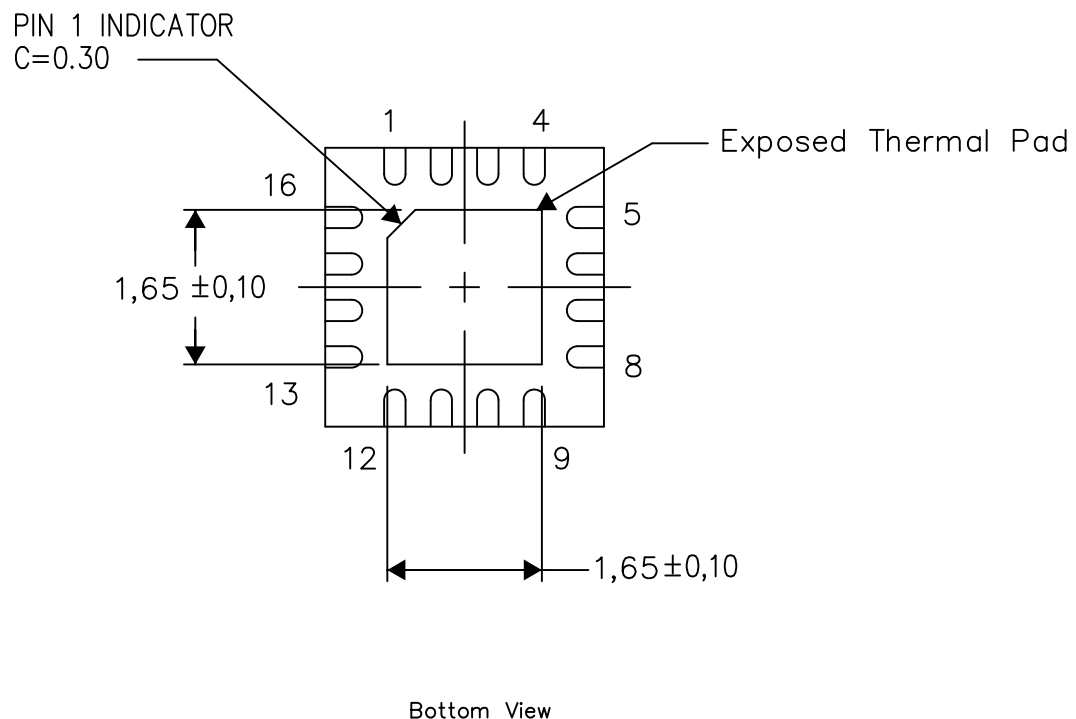

Exposed Thermal Pad Dimensions

4206349-7/T 05/13

NOTE: All linear dimensions are in millimeters

RGT (S-PVQFN-N16)

PLASTIC QUAD FLATPACK NO-LEAD

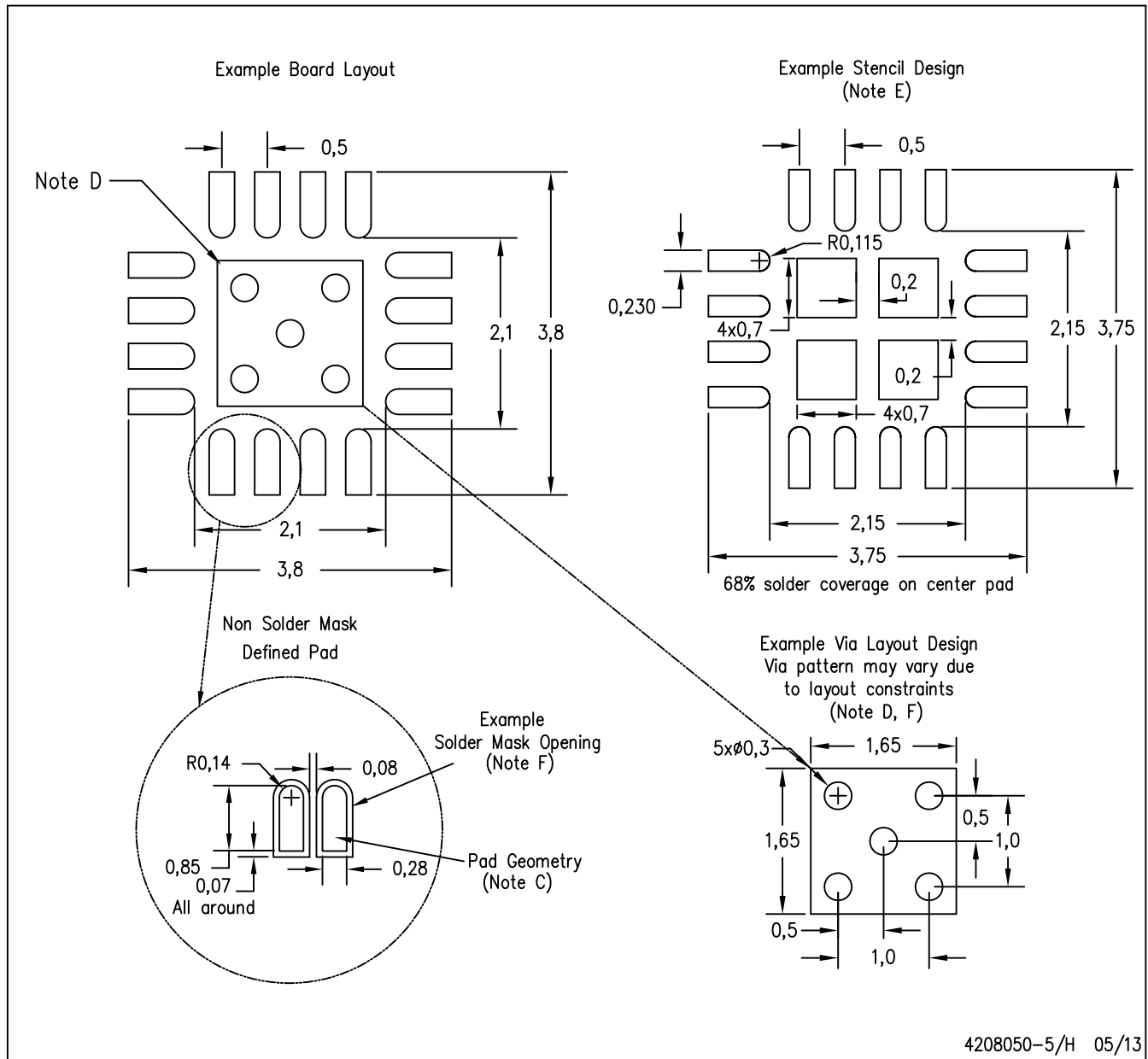

- NOTES:
- All linear dimensions are in millimeters.
 - This drawing is subject to change without notice.
 - Publication IPC-7351 is recommended for alternate designs.
 - This package is designed to be soldered to a thermal pad on the board. Refer to Application Note, QFN/SON PCB Attachment, Texas Instruments Literature No. SLUA271, and also the Product Data Sheets for specific thermal information, via requirements, and recommended board layout. These documents are available at www.ti.com <<http://www.ti.com>>.
 - Laser cutting apertures with trapezoidal walls and also rounding corners will offer better paste release. Customers should contact their board assembly site for stencil design recommendations. Refer to IPC 7525 for stencil design considerations.
 - Customers should contact their board fabrication site for minimum solder mask web tolerances between signal pads.

THERMAL PAD MECHANICAL DATA

RGT (S-PVQFN-N16)

PLASTIC QUAD FLATPACK NO-LEAD

THERMAL INFORMATION

This package incorporates an exposed thermal pad that is designed to be attached directly to an external heatsink. The thermal pad must be soldered directly to the printed circuit board (PCB). After soldering, the PCB can be used as a heatsink. In addition, through the use of thermal vias, the thermal pad can be attached directly to the appropriate copper plane shown in the electrical schematic for the device, or alternatively, can be attached to a special heatsink structure designed into the PCB. This design optimizes the heat transfer from the integrated circuit (IC).

For information on the Quad Flatpack No-Lead (QFN) package and its advantages, refer to Application Report, QFN/SON PCB Attachment, Texas Instruments Literature No. SLUA271. This document is available at www.ti.com.

The exposed thermal pad dimensions for this package are shown in the following illustration.

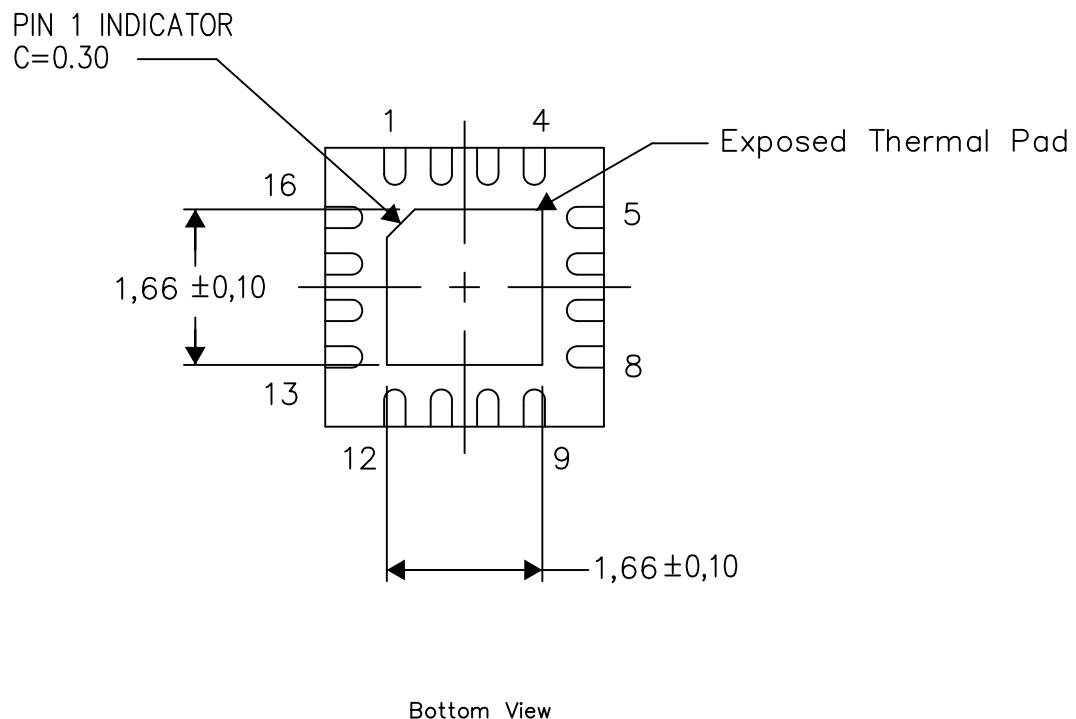

Exposed Thermal Pad Dimensions

4206349-9/T 05/13

NOTE: All linear dimensions are in millimeters

IMPORTANT NOTICE

Texas Instruments Incorporated and its subsidiaries (TI) reserve the right to make corrections, enhancements, improvements and other changes to its semiconductor products and services per JESD46, latest issue, and to discontinue any product or service per JESD48, latest issue. Buyers should obtain the latest relevant information before placing orders and should verify that such information is current and complete. All semiconductor products (also referred to herein as "components") are sold subject to TI's terms and conditions of sale supplied at the time of order acknowledgment.

TI warrants performance of its components to the specifications applicable at the time of sale, in accordance with the warranty in TI's terms and conditions of sale of semiconductor products. Testing and other quality control techniques are used to the extent TI deems necessary to support this warranty. Except where mandated by applicable law, testing of all parameters of each component is not necessarily performed.

TI assumes no liability for applications assistance or the design of Buyers' products. Buyers are responsible for their products and applications using TI components. To minimize the risks associated with Buyers' products and applications, Buyers should provide adequate design and operating safeguards.

TI does not warrant or represent that any license, either express or implied, is granted under any patent right, copyright, mask work right, or other intellectual property right relating to any combination, machine, or process in which TI components or services are used. Information published by TI regarding third-party products or services does not constitute a license to use such products or services or a warranty or endorsement thereof. Use of such information may require a license from a third party under the patents or other intellectual property of the third party, or a license from TI under the patents or other intellectual property of TI.

Reproduction of significant portions of TI information in TI data books or data sheets is permissible only if reproduction is without alteration and is accompanied by all associated warranties, conditions, limitations, and notices. TI is not responsible or liable for such altered documentation. Information of third parties may be subject to additional restrictions.

Resale of TI components or services with statements different from or beyond the parameters stated by TI for that component or service voids all express and any implied warranties for the associated TI component or service and is an unfair and deceptive business practice. TI is not responsible or liable for any such statements.

Buyer acknowledges and agrees that it is solely responsible for compliance with all legal, regulatory and safety-related requirements concerning its products, and any use of TI components in its applications, notwithstanding any applications-related information or support that may be provided by TI. Buyer represents and agrees that it has all the necessary expertise to create and implement safeguards which anticipate dangerous consequences of failures, monitor failures and their consequences, lessen the likelihood of failures that might cause harm and take appropriate remedial actions. Buyer will fully indemnify TI and its representatives against any damages arising out of the use of any TI components in safety-critical applications.

In some cases, TI components may be promoted specifically to facilitate safety-related applications. With such components, TI's goal is to help enable customers to design and create their own end-product solutions that meet applicable functional safety standards and requirements. Nonetheless, such components are subject to these terms.

No TI components are authorized for use in FDA Class III (or similar life-critical medical equipment) unless authorized officers of the parties have executed a special agreement specifically governing such use.

Only those TI components which TI has specifically designated as military grade or "enhanced plastic" are designed and intended for use in military/aerospace applications or environments. Buyer acknowledges and agrees that any military or aerospace use of TI components which have **not** been so designated is solely at the Buyer's risk, and that Buyer is solely responsible for compliance with all legal and regulatory requirements in connection with such use.

TI has specifically designated certain components as meeting ISO/TS16949 requirements, mainly for automotive use. In any case of use of non-designated products, TI will not be responsible for any failure to meet ISO/TS16949.

Products

Audio	www.ti.com/audio
Amplifiers	amplifier.ti.com
Data Converters	dataconverter.ti.com
DLP® Products	www.dlp.com
DSP	dsp.ti.com
Clocks and Timers	www.ti.com/clocks
Interface	interface.ti.com
Logic	logic.ti.com
Power Mgmt	power.ti.com
Microcontrollers	microcontroller.ti.com
RFID	www.ti-rfid.com
OMAP Applications Processors	www.ti.com/omap
Wireless Connectivity	www.ti.com/wirelessconnectivity

Applications

Automotive and Transportation	www.ti.com/automotive
Communications and Telecom	www.ti.com/communications
Computers and Peripherals	www.ti.com/computers
Consumer Electronics	www.ti.com/consumer-apps
Energy and Lighting	www.ti.com/energy
Industrial	www.ti.com/industrial
Medical	www.ti.com/medical
Security	www.ti.com/security
Space, Avionics and Defense	www.ti.com/space-avionics-defense
Video and Imaging	www.ti.com/video

TI E2E Community

e2e.ti.com