

# TL322C, TL322I DUAL LOW-POWER OPERATIONAL AMPLIFIERS

SLOS086 – D2567, OCTOBER 1979 – REVISED OCTOBER 1990

- **Wide Range of Supply Voltages**  
Single Supply . . . 5 V to 30 V  
Dual Supplies . . .  $\pm 2.5$  V to  $\pm 15$  V
- **Class AB Output Stage**
- **True Differential Input Stage**
- **Low Input Bias Current**
- **Internal Frequency Compensation**
- **Short-Circuit Protection**

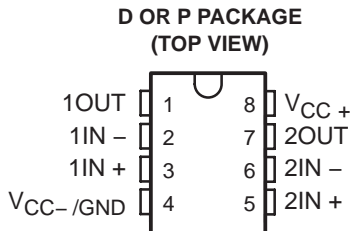

symbol (each amplifier)

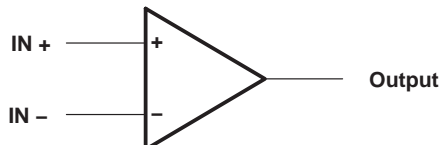

## description

The TL322C and the TL322I are dual operational amplifiers similar in performance to the  $\mu$ A741 but with several distinct advantages. They are designed to operate from a single supply over a range of voltages from 5 V to 30 V. Operation from split supplies is also possible provided the difference between the two supplies is 5 V to 30 V. The common-mode input range includes the negative supply. Output range is from the negative supply to  $V_{CC} - 1.5$  V. Quiescent supply currents per amplifier are typically less than one-half those of the  $\mu$ A741.

The TL322C is characterized for operation from 0°C to 70°C. The TL322I is characterized for operation from -40°C to 85°C.

## AVAILABLE OPTIONS

TA	V <sub>IO</sub> MAX AT 25°C	PACKAGE	
		SMALL OUTLINE (D)	PLASTIC DIP (P)
0°C to 70°C	10 mV	TL322CD	TL322CP
0°C to 70°C	8 mV	TL322ID	TL322IP

D packages are available taped and reeled. Add R suffix to device type, (e.g., TL322CDR).

## schematic (each amplifier)

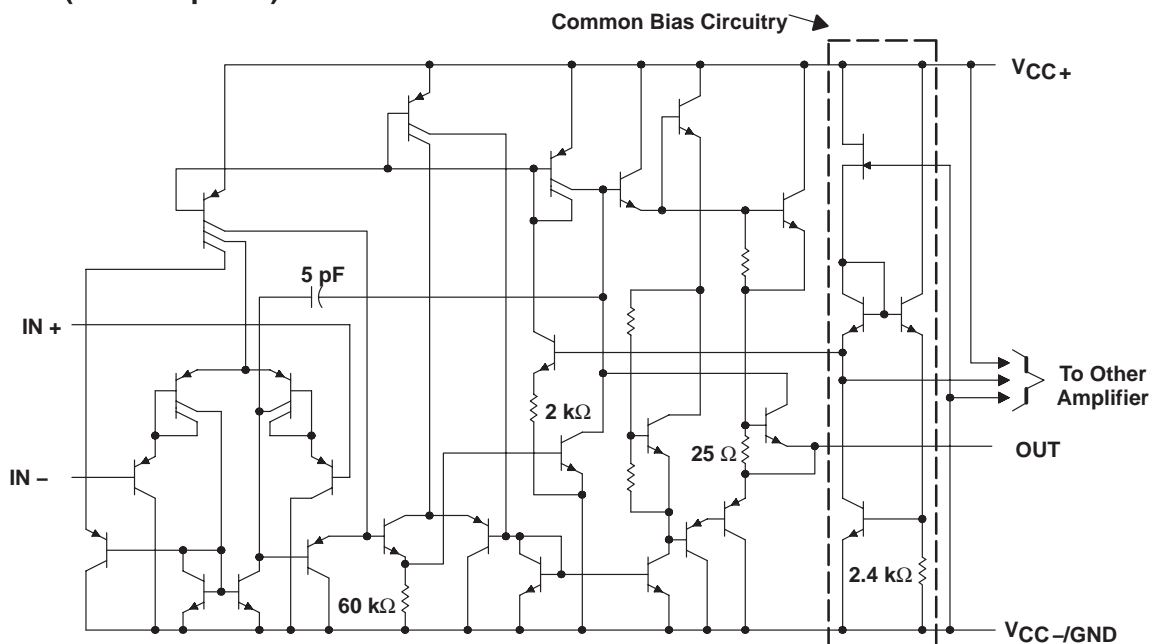

All component values shown are nominal.

PRODUCTION DATA information is current as of publication date. Products conform to specifications per the terms of Texas Instruments standard warranty. Production processing does not necessarily include testing of all parameters.

**TEXAS  
INSTRUMENTS**

POST OFFICE BOX 655303 • DALLAS, TEXAS 75265  
POST OFFICE BOX 1443 • HOUSTON, TEXAS 77001

Copyright © 1990, Texas Instruments Incorporated

# TL322C, TL322I

## DUAL LOW-POWER OPERATIONAL AMPLIFIERS

SLOS086 – D2567, OCTOBER 1979 – REVISED OCTOBER 1990

### absolute maximum ratings over operating free-air temperature range (unless otherwise noted)

	TL322C	TL322I	UNIT
Supply voltage $V_{CC+}$ (see Note 1)	18	18	V
Supply voltage $V_{CC-}$ (see Note 1)	-18	-18	V
Supply voltage $V_{CC+}$ (with respect to $V_{CC-}$ )	36	36	V
Differential input voltage (see Note 2)	$\pm 36$	$\pm 36$	V
Input voltage (see Notes 1 and 3)	$\pm 18$	$\pm 18$	V
Continuous total power dissipation	See Dissipation Rating Table		
Operating free-air temperature range	0 to 70	-40 to 85	$^{\circ}\text{C}$
Storage temperature range	-65 to 150	-65 to 150	$^{\circ}\text{C}$
Lead temperature 1,6 mm (1/16 inch) from case for 10 seconds	260	260	$^{\circ}\text{C}$

- NOTES: 1. These voltage values are with respect to the midpoint between  $V_{CC+}$  and  $V_{CC-}$ .  
 2. Differential voltages are at the noninverting input terminal with respect to the inverting input terminal.  
 3. Neither input must ever be more positive than  $V_{CC+}$  or more negative than  $V_{CC-}$ .

DISSIPATION RATING TABLE

PACKAGE	$T_A \leq 25^{\circ}\text{C}$ POWER RATING	DERATING FACTOR	DERATE ABOVE $T_A$	$T_A = 70^{\circ}\text{C}$ POWER RATING	$T_A = 85^{\circ}\text{C}$ POWER RATING
D	680 mW	5.8 mW/ $^{\circ}\text{C}$	33 $^{\circ}\text{C}$	464 mW	377 mW
P	680 mW	8.0 mW/ $^{\circ}\text{C}$	65 $^{\circ}\text{C}$	640 mW	520 mW

### recommended operating conditions

	MIN	NOM	MAX	UNIT
Single supply voltage, $V_{CC}$	5		30	V
Dual supply voltage, $V_{CC+}$	2.5		15	V
Dual supply voltage, $V_{CC-}$	-2.5		-15	V

# TL322C, TL322I

## DUAL LOW-POWER OPERATIONAL AMPLIFIERS

SLOS086 – D2567, OCTOBER 1979 – REVISED OCTOBER 1990

**electrical characteristics at specified free-air temperature,  $V_{CC\pm} = 15\text{ V}$  (unless otherwise noted)**

PARAMETER	TEST CONDITIONS†	TL322C			TL322I			UNIT
		MIN	TYP	MAX	MIN	TYP	MAX	
$V_{IO}$ Input offset voltage	$V_O = 0,$ $R_S = 50\ \Omega$	25°C	2	10	2	8	mV	
		Full range		12		10		
$\alpha_{VIO}$ Temperature coefficient of input offset voltage	$V_O = 0,$ $R_S = 50\ \Omega$	25°C	10		10		$\mu\text{V}/^\circ\text{C}$	
$I_{IO}$ Input offset current	$V_O = 0$	25°C	30	50	30	75	nA	
		Full range		200		250		
$\alpha_{IIO}$ Temperature coefficient of input offset current	$V_O = 0$	25°C	50		50		$\text{pA}/^\circ\text{C}$	
$I_{IB}$ Input bias current	$V_O = 0$	25°C	-0.2	-0.5	-0.2	-0.5	$\mu\text{A}$	
		Full range		-0.8		-1		
$V_{ICR}$ Common-mode input voltage range‡		25°C	$V_{CC-}$ to 13	$V_{CC-}$ to 13.5	$V_{CC-}$ to 13	$V_{CC-}$ to 13.5	V	
$V_{OM}$ Peak output voltage swing	$R_L = 10\ \text{k}\Omega$	25°C	$\pm 12$	$\pm 13.5$	$\pm 12$	$\pm 12.5$	V	
		25°C	$\pm 10$	$\pm 13$	$\pm 10$	$\pm 12$		
		Full range	$\pm 10$		$\pm 10$			
$A_{VD}$ Large-signal differential voltage amplification	$V_O = \pm 10\ \text{V},$ $R_L = 2\ \text{k}\Omega$	25°C	20	200	20	200	V/mV	
		Full range	15		15			
$B_{OM}$ Maximum-output-swing bandwidth	$V_{O(PP)} = 20\ \text{V},$ $A_{VD} = 1,$ $\text{THD} \leq 5\%,$ $R_L = 2\ \text{k}\Omega$	25°C		9		9	kHz	
$B_1$ Unity-gain bandwidth	$V_O = 50\ \text{mV},$ $R_L = 10\ \text{k}\Omega$	25°C		1		1	MHz	
$\phi_m$ Phase margin	$R_L = 2\ \text{k}\Omega,$ $C_L = 200\ \text{pF}$	25°C		60°		60°		
$r_i$ Input resistance	$f = 20\ \text{Hz}$	25°C	0.3	1	0.3	1	$\text{M}\Omega$	
$r_o$ Output resistance	$f = 20\ \text{Hz}$	25°C		75		75	$\Omega$	
CMRR Common-mode rejection ratio	$V_{IC} = V_{ICR}\ \text{min},$ $R_S = 50\ \Omega$	25°C	70	90	70	90	dB	
$k_{SVS}$ Supply voltage sensitivity ( $\Delta V_{IO}/\Delta V_{CC}$ )	$V_{CC} = \pm 2.5\ \text{V}$ to $\pm 15\ \text{V},$ $R_S = 50\ \Omega$	25°C		30 150		30 150	$\mu\text{V}/\text{V}$	
$I_{OS}$ Short-circuit output current§	$V_O = 0$	25°C	$\pm 10$	$\pm 30$ $\pm 45$	$\pm 10$	$\pm 30$ $\pm 45$	mA	
$I_{CC}$ Total supply current	$V_O = 0,$ No load	25°C		1.4 4		1.4 4	mA	

† All characteristics are under open-loop conditions unless otherwise noted. Full range for  $T_A$  is 0°C to 70°C for TL322C and -40°C to 85°C for TL322I.

‡ The  $V_{ICR}$  limits are directly linked volt-for-volt to supply voltage; the positive limit is 2 V less than  $V_{CC+}$ .

§ Temperature and/or supply voltages must be limited to ensure that the dissipation rating is not exceeded.



# TL322C, TL322I

## DUAL LOW-POWER OPERATIONAL AMPLIFIERS

SLOS086 – D2567, OCTOBER 1979 – REVISED OCTOBER 1990

electrical characteristics,  $V_{CC+} = 5\text{ V}$ ,  $V_{CC-} = 0\text{ V}$ ,  $T_A = 25^\circ\text{C}$  (unless otherwise noted)

PARAMETER	TEST CONDITIONS†	TL322C			TL322I			UNIT
		MIN	TYP	MAX	MIN	TYP	MAX	
$V_{IO}$	Input offset voltage	$V_O = 2.5\text{ V}$ , $R_S = 50\ \Omega$			8			mV
$I_{IO}$	Input offset current	$V_O = 2.5\text{ V}$			75			nA
$I_{IB}$	Input bias current				-0.5			pA
$V_{OM}$	Peak output voltage swing‡	$R_L = 10\text{ k}\Omega$			3.3 3.5			V
		$R_L = 10\text{ k}\Omega$ , $V_{CC+} = 5\text{ V to } 30\text{ V}$			$V_{CC+} - 1.7$			
$A_{VD}$	Large-signal differential voltage amplification	$V_O = 1.7\text{ V to } 3.3\text{ V}$ , $R_L = 2\text{ k}\Omega$			20 200			V/mV
$k_{SVS}$	Supply voltage sensitivity ( $\Delta V_{IO}/\Delta V_{CC+}$ )	$V_{CC} = \pm 2.5\text{ V to } \pm 15\text{ V}$			150			$\mu\text{V/V}$
$I_{CC}$	Supply current	$V_O = 2.5\text{ V}$ , No load			1.2 4			mA
$V_{O1}/V_{O2}$	Crosstalk attenuation	$A_{VD} = 100$ , $f = 1\text{ kHz to } 20\text{ kHz}$			120			dB

† All characteristics are specified under open-loop conditions.

‡ Output will swing essentially to ground.

switching characteristics,  $V_{CC+} = 15\text{ V}$ ,  $V_{CC-} = -15\text{ V}$ ,  $A_{VD} = 1$ ,  $T_A = 25^\circ\text{C}$  (unless otherwise noted)

PARAMETER	TEST CONDITIONS	MIN	TYP	MAX	UNIT	
SR	Slew rate at unity gain	$V_I = \pm 10\text{ V}$ , $C_L = 100\text{ pF}$ , See Figure 1			0.6	$\text{V}/\mu\text{s}$
$t_r$	Rise time	$\Delta V_O = 50\text{ mV}$ , $C_L = 100\text{ pF}$ , $R_L = 10\text{ k}\Omega$ , See Figure 1			0.35	$\mu\text{s}$
$t_f$	Fall time				0.35	$\mu\text{s}$
	Overshoot factor				20%	
	Crossover distortion	$V_{I(PP)} = 30\text{ mV}$ , $V_{O(PP)} = 2\text{ V}$ , $f = 10\text{ kHz}$			1%	

### PARAMETER MEASUREMENT INFORMATION

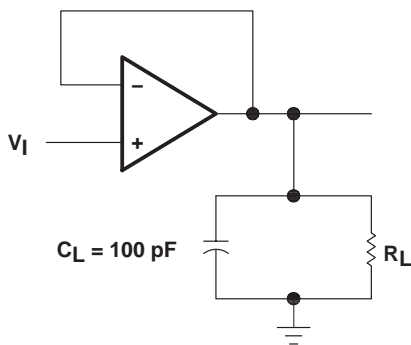

Figure 1. Unity-Gain Amplifier

TYPICAL CHARACTERISTICS†

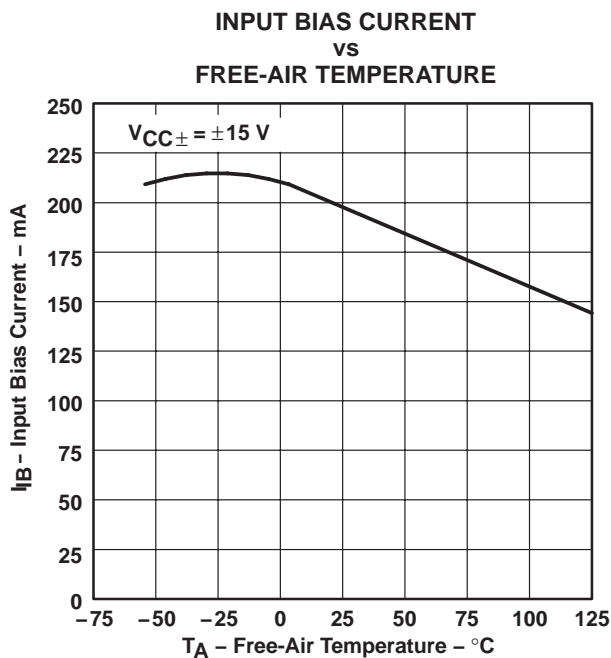

Figure 2

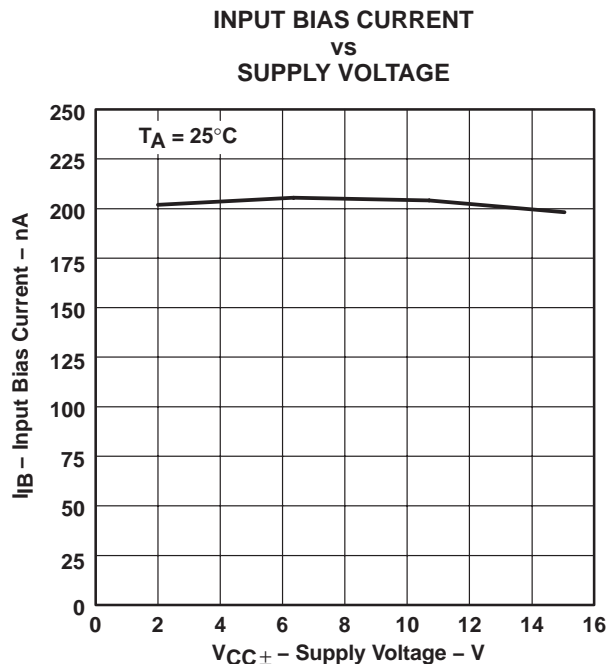

Figure 3

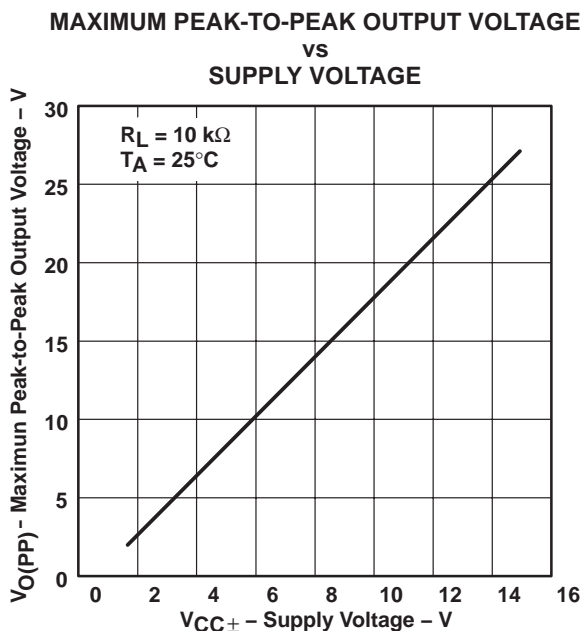

Figure 4

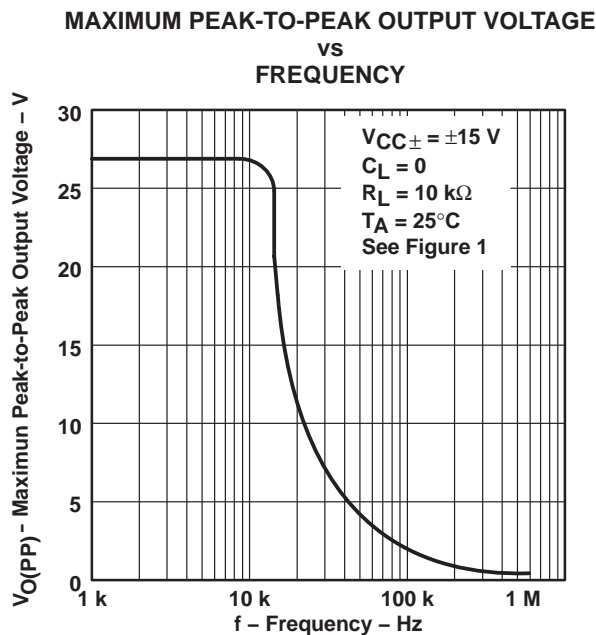

Figure 5

† Data at high and low temperatures are applicable only within the rated operating free-air temperature ranges of the various devices.

# TL322C, TL322I DUAL LOW-POWER OPERATIONAL AMPLIFIERS

SLOS086 – D2567, OCTOBER 1979 – REVISED OCTOBER 1990

## TYPICAL CHARACTERISTICS

**LARGE-SIGNAL  
DIFFERENTIAL VOLTAGE AMPLIFICATION  
VS  
FREQUENCY**

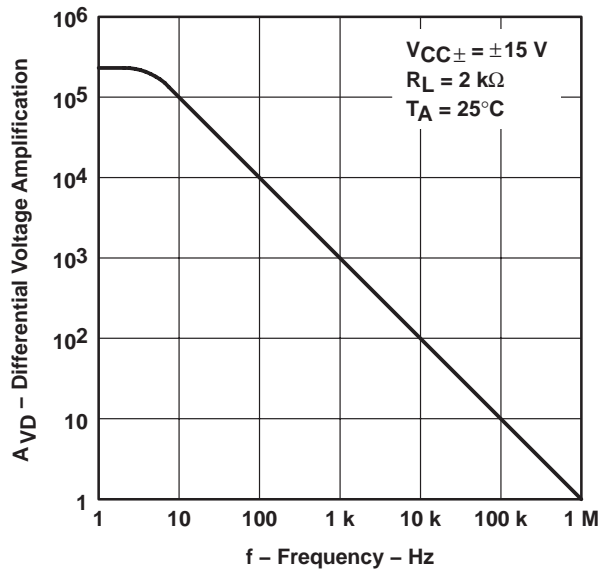

Figure 6

**VOLTAGE-FOLLOWER  
LARGE-SIGNAL PULSE RESPONSE**

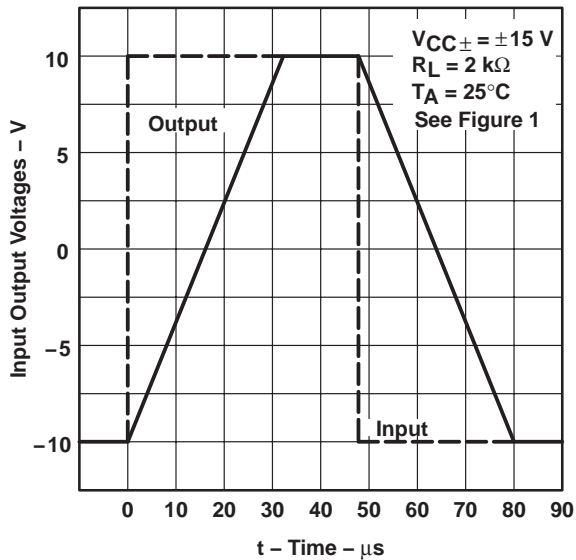

Figure 7

**PACKAGING INFORMATION**

Orderable Device	Status <sup>(1)</sup>	Package Type	Package Drawing	Pins	Package Qty	Eco Plan <sup>(2)</sup>	Lead/ Ball Finish	MSL Peak Temp <sup>(3)</sup>	Samples (Requires Login)
TL322CP	OBSOLETE	PDIP	P	8		TBD	Call TI	Call TI	Samples Not Available
TL322ID	OBSOLETE	SOIC	D	8		TBD	Call TI	Call TI	Samples Not Available
TL322ID	OBSOLETE	SOIC	D	8		TBD	Call TI	Call TI	Samples Not Available
TL322IP	OBSOLETE	PDIP	P	8		TBD	Call TI	Call TI	Samples Not Available
TL322IP	OBSOLETE	PDIP	P	8		TBD	Call TI	Call TI	Samples Not Available

<sup>(1)</sup> The marketing status values are defined as follows:

**ACTIVE:** Product device recommended for new designs.

**LIFEBUY:** TI has announced that the device will be discontinued, and a lifetime-buy period is in effect.

**NRND:** Not recommended for new designs. Device is in production to support existing customers, but TI does not recommend using this part in a new design.

**PREVIEW:** Device has been announced but is not in production. Samples may or may not be available.

**OBSOLETE:** TI has discontinued the production of the device.

<sup>(2)</sup> Eco Plan - The planned eco-friendly classification: Pb-Free (RoHS), Pb-Free (RoHS Exempt), or Green (RoHS & no Sb/Br) - please check <http://www.ti.com/productcontent> for the latest availability information and additional product content details.

**TBD:** The Pb-Free/Green conversion plan has not been defined.

**Pb-Free (RoHS):** TI's terms "Lead-Free" or "Pb-Free" mean semiconductor products that are compatible with the current RoHS requirements for all 6 substances, including the requirement that lead not exceed 0.1% by weight in homogeneous materials. Where designed to be soldered at high temperatures, TI Pb-Free products are suitable for use in specified lead-free processes.

**Pb-Free (RoHS Exempt):** This component has a RoHS exemption for either 1) lead-based flip-chip solder bumps used between the die and package, or 2) lead-based die adhesive used between the die and leadframe. The component is otherwise considered Pb-Free (RoHS compatible) as defined above.

**Green (RoHS & no Sb/Br):** TI defines "Green" to mean Pb-Free (RoHS compatible), and free of Bromine (Br) and Antimony (Sb) based flame retardants (Br or Sb do not exceed 0.1% by weight in homogeneous material)

<sup>(3)</sup> MSL, Peak Temp. -- The Moisture Sensitivity Level rating according to the JEDEC industry standard classifications, and peak solder temperature.

**Important Information and Disclaimer:** The information provided on this page represents TI's knowledge and belief as of the date that it is provided. TI bases its knowledge and belief on information provided by third parties, and makes no representation or warranty as to the accuracy of such information. Efforts are underway to better integrate information from third parties. TI has taken and continues to take reasonable steps to provide representative and accurate information but may not have conducted destructive testing or chemical analysis on incoming materials and chemicals. TI and TI suppliers consider certain information to be proprietary, and thus CAS numbers and other limited information may not be available for release.

In no event shall TI's liability arising out of such information exceed the total purchase price of the TI part(s) at issue in this document sold by TI to Customer on an annual basis.

P (R-PDIP-T8)

PLASTIC DUAL-IN-LINE PACKAGE



- NOTES:
- A. All linear dimensions are in inches (millimeters).
  - B. This drawing is subject to change without notice.
  - C. Falls within JEDEC MS-001 variation BA.



D (R-PDSO-G8)

PLASTIC SMALL OUTLINE



4040047-3/M 06/11

## IMPORTANT NOTICE

Texas Instruments Incorporated and its subsidiaries (TI) reserve the right to make corrections, modifications, enhancements, improvements, and other changes to its products and services at any time and to discontinue any product or service without notice. Customers should obtain the latest relevant information before placing orders and should verify that such information is current and complete. All products are sold subject to TI's terms and conditions of sale supplied at the time of order acknowledgment.

TI warrants performance of its hardware products to the specifications applicable at the time of sale in accordance with TI's standard warranty. Testing and other quality control techniques are used to the extent TI deems necessary to support this warranty. Except where mandated by government requirements, testing of all parameters of each product is not necessarily performed.

TI assumes no liability for applications assistance or customer product design. Customers are responsible for their products and applications using TI components. To minimize the risks associated with customer products and applications, customers should provide adequate design and operating safeguards.

TI does not warrant or represent that any license, either express or implied, is granted under any TI patent right, copyright, mask work right, or other TI intellectual property right relating to any combination, machine, or process in which TI products or services are used. Information published by TI regarding third-party products or services does not constitute a license from TI to use such products or services or a warranty or endorsement thereof. Use of such information may require a license from a third party under the patents or other intellectual property of the third party, or a license from TI under the patents or other intellectual property of TI.

Reproduction of TI information in TI data books or data sheets is permissible only if reproduction is without alteration and is accompanied by all associated warranties, conditions, limitations, and notices. Reproduction of this information with alteration is an unfair and deceptive business practice. TI is not responsible or liable for such altered documentation. Information of third parties may be subject to additional restrictions.

Resale of TI products or services with statements different from or beyond the parameters stated by TI for that product or service voids all express and any implied warranties for the associated TI product or service and is an unfair and deceptive business practice. TI is not responsible or liable for any such statements.

TI products are not authorized for use in safety-critical applications (such as life support) where a failure of the TI product would reasonably be expected to cause severe personal injury or death, unless officers of the parties have executed an agreement specifically governing such use. Buyers represent that they have all necessary expertise in the safety and regulatory ramifications of their applications, and acknowledge and agree that they are solely responsible for all legal, regulatory and safety-related requirements concerning their products and any use of TI products in such safety-critical applications, notwithstanding any applications-related information or support that may be provided by TI. Further, Buyers must fully indemnify TI and its representatives against any damages arising out of the use of TI products in such safety-critical applications.

TI products are neither designed nor intended for use in military/aerospace applications or environments unless the TI products are specifically designated by TI as military-grade or "enhanced plastic." Only products designated by TI as military-grade meet military specifications. Buyers acknowledge and agree that any such use of TI products which TI has not designated as military-grade is solely at the Buyer's risk, and that they are solely responsible for compliance with all legal and regulatory requirements in connection with such use.

TI products are neither designed nor intended for use in automotive applications or environments unless the specific TI products are designated by TI as compliant with ISO/TS 16949 requirements. Buyers acknowledge and agree that, if they use any non-designated products in automotive applications, TI will not be responsible for any failure to meet such requirements.

Following are URLs where you can obtain information on other Texas Instruments products and application solutions:

### Products

Audio	<a href="http://www.ti.com/audio">www.ti.com/audio</a>
Amplifiers	<a href="http://amplifier.ti.com">amplifier.ti.com</a>
Data Converters	<a href="http://dataconverter.ti.com">dataconverter.ti.com</a>
DLP® Products	<a href="http://www.dlp.com">www.dlp.com</a>
DSP	<a href="http://dsp.ti.com">dsp.ti.com</a>
Clocks and Timers	<a href="http://www.ti.com/clocks">www.ti.com/clocks</a>
Interface	<a href="http://interface.ti.com">interface.ti.com</a>
Logic	<a href="http://logic.ti.com">logic.ti.com</a>
Power Mgmt	<a href="http://power.ti.com">power.ti.com</a>
Microcontrollers	<a href="http://microcontroller.ti.com">microcontroller.ti.com</a>
RFID	<a href="http://www.ti-rfid.com">www.ti-rfid.com</a>
RF/IF and ZigBee® Solutions	<a href="http://www.ti.com/lprf">www.ti.com/lprf</a>

### Applications

Communications and Telecom	<a href="http://www.ti.com/communications">www.ti.com/communications</a>
Computers and Peripherals	<a href="http://www.ti.com/computers">www.ti.com/computers</a>
Consumer Electronics	<a href="http://www.ti.com/consumer-apps">www.ti.com/consumer-apps</a>
Energy and Lighting	<a href="http://www.ti.com/energy">www.ti.com/energy</a>
Industrial	<a href="http://www.ti.com/industrial">www.ti.com/industrial</a>
Medical	<a href="http://www.ti.com/medical">www.ti.com/medical</a>
Security	<a href="http://www.ti.com/security">www.ti.com/security</a>
Space, Avionics and Defense	<a href="http://www.ti.com/space-avionics-defense">www.ti.com/space-avionics-defense</a>
Transportation and Automotive	<a href="http://www.ti.com/automotive">www.ti.com/automotive</a>
Video and Imaging	<a href="http://www.ti.com/video">www.ti.com/video</a>
Wireless	<a href="http://www.ti.com/wireless-apps">www.ti.com/wireless-apps</a>

TI E2E Community Home Page

[e2e.ti.com](http://e2e.ti.com)

Mailing Address: Texas Instruments, Post Office Box 655303, Dallas, Texas 75265  
Copyright © 2011, Texas Instruments Incorporated