

# TL070 JFET-INPUT OPERATIONAL AMPLIFIER

SLOS121B – NOVEMBER 1993 – REVISED MARCH 2001

- Low Power Consumption
- Wide Common-Mode and Differential Voltage Ranges
- Low Input-Bias and Offset Currents
- Output Short-Circuit Protection
- Low Total Harmonic Distortion . . . 0.003% Typ
- Low Noise . . .  $V_n = 18 \text{ nV}/\sqrt{\text{Hz}}$  Typ at  $f = 1 \text{ kHz}$
- High Input Impedance . . . JFET Input Stage
- Common-Mode Input Voltage Range Includes  $V_{CC+}$
- Latch-Up-Free Operation
- High Slew Rate . . .  $13 \text{ V}/\mu\text{s}$  Typ

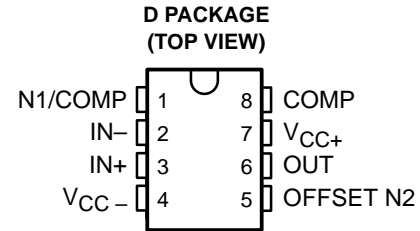

## description

The JFET-input TL070 operational amplifier is designed as the lower-noise version of the TL080 amplifier with low input-bias and offset currents and fast slew rate. The low harmonic distortion and low noise make the TL070 ideally suited for high-fidelity and audio-preamplifier applications. This amplifier features JFET inputs (for high input impedance) coupled with bipolar output stages integrated on a single monolithic chip.

The TL070I device is characterized for operation from  $-40^\circ\text{C}$  to  $85^\circ\text{C}$ .

## AVAILABLE OPTIONS

$T_A$	$V_{IOmax}$ AT $25^\circ\text{C}$	PACKAGE
		SMALL OUTLINE (D)
$-40^\circ\text{C}$ to $85^\circ\text{C}$	10 mV	TL070ID

## logic symbol†

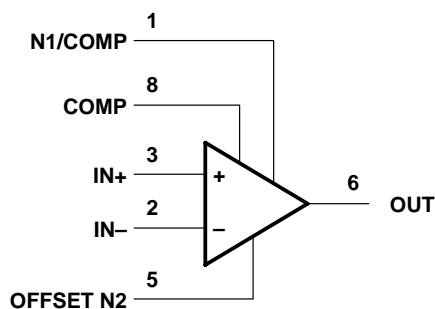

† This symbol is in accordance with ANSI/IEEE Std 91-1984 and IEC Publication 617-12.



Please be aware that an important notice concerning availability, standard warranty, and use in critical applications of Texas Instruments semiconductor products and disclaimers thereto appears at the end of this data sheet.

PRODUCTION DATA information is current as of publication date. Products conform to specifications per the terms of Texas Instruments standard warranty. Production processing does not necessarily include testing of all parameters.

 **TEXAS  
INSTRUMENTS**

POST OFFICE BOX 655303 • DALLAS, TEXAS 75265

Copyright © 2001, Texas Instruments Incorporated

# TL070 JFET-INPUT OPERATIONAL AMPLIFIER

SLOS121B – NOVEMBER 1993 – REVISED MARCH 2001

## schematic

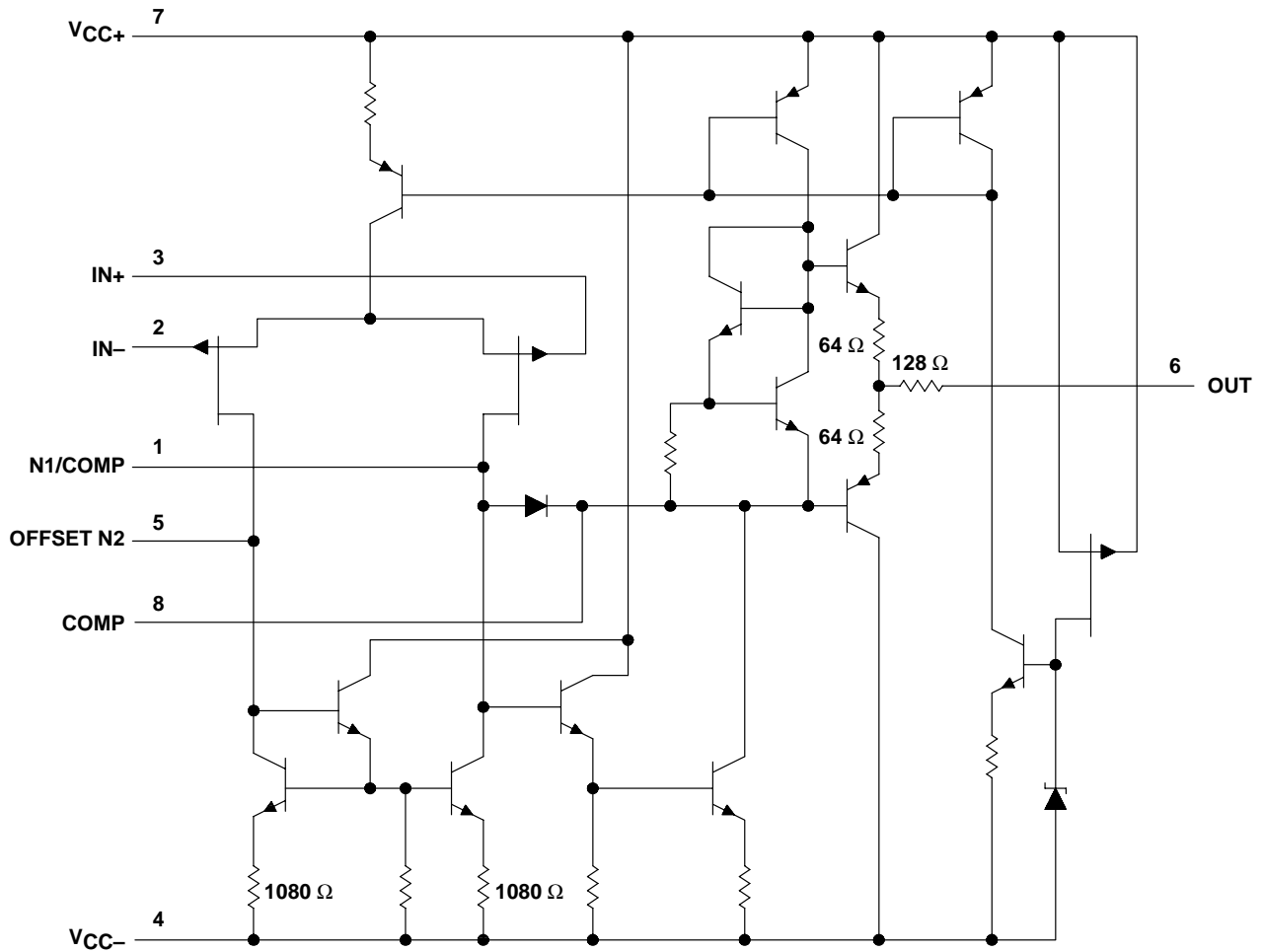

All component values shown are nominal.

COMPONENT COUNT†	
Transistors	13
Diodes	2
Resistors	10
epi-FET	1
JFET	2

† Includes all bias and trim circuitry

**absolute maximum ratings over operating free-air temperature range (unless otherwise noted)†**

Supply voltage, $V_{CC+}$ (see Note 1)	18 V
Supply voltage, $V_{CC-}$	-18 V
Differential input voltage, $V_{ID}$ (see Note 2)	$\pm 30$ V
Input voltage, $V_I$ (see Notes 1 and 3)	$\pm 15$ V
Duration of short-circuit current (see Note 4)	Unlimited
Package thermal impedance, $\theta_{JA}$ (see Note 5): D package	97°C/W
PW package	149°C/W
Lead temperature 1,6 mm (1/16 inch) from case for 10 seconds	260°C
Storage temperature range, $T_{stg}$	-65°C to 150°C

† Stresses beyond those listed under “absolute maximum ratings” may cause permanent damage to the device. These are stress ratings only, and functional operation of the device at these or any other conditions beyond those indicated under “recommended operating conditions” is not implied. Exposure to absolute-maximum-rated conditions for extended periods may affect device reliability.

- NOTES:
1. All voltage values, except differential voltages, are with respect to the midpoint between  $V_{CC+}$  and  $V_{CC-}$ .
  2. Differential voltages are at  $IN+$  with respect to  $IN-$ .
  3. The magnitude of the input voltage must never exceed the magnitude of the supply voltage or 15 V, whichever is less.
  4. The output may be shorted to ground or to either supply. Temperature and/or supply voltages must be limited to ensure that the dissipation rating is not exceeded.
  5. The package thermal impedance is calculated in accordance with JESD 51-7.

# TL070

## JFET-INPUT OPERATIONAL AMPLIFIER

SLOS121B – NOVEMBER 1993 – REVISED MARCH 2001

### electrical characteristics, $V_{CC\pm} = \pm 15\text{ V}$ (unless otherwise noted)

PARAMETER		TEST CONDITIONS	$T_A$ †	MIN	TYP	MAX	UNIT
$V_{IO}$	Input offset voltage	$V_O = 0, R_S = 50\ \Omega$	25°C		3	10	mV
			Full range			13	
$\alpha_{V_{IO}}$	Temperature coefficient of input offset voltage	$V_O = 0, R_S = 50\ \Omega$	Full range		18		$\mu\text{V}/^\circ\text{C}$
$I_{IO}$	Input offset current	$V_O = 0$	25°C		5	100	pA
			Full range			10	nA
$I_{IB}$	Input bias current‡	$V_O = 0$	25°C		65	200	pA
			Full range			20	nA
$V_{ICR}$	Common-mode input voltage range		25°C	$\pm 11$	-12 to 15		V
$V_{OM}$	Maximum peak output voltage swing	$R_L = 10\ \text{k}\Omega$	25°C	$\pm 12$	$\pm 13.5$		V
		$R_L \geq 10\ \text{k}\Omega$	Full range	$\pm 12$			
		$R_L \geq 2\ \text{k}\Omega$		$\pm 10$			
$A_{VD}$	Large-signal differential voltage amplification	$V_O = \pm 10\ \text{V}, R_L \geq 2\ \text{k}\Omega$	25°C	25	200		V/mV
			Full range	15			
$B_1$	Unity-gain bandwidth		25°C		3		MHz
$r_i$	Input resistance		25°C		$10^{12}$		$\Omega$
CMRR	Common-mode rejection ratio	$V_{IC} = V_{ICRmin}, V_O = 0, R_S = 50\ \Omega$	25°C	70	100		dB
$k_{SVR}$	Supply-voltage rejection ratio ( $\Delta V_{CC\pm}/\Delta V_{IO}$ )	$V_{CC} = \pm 9\ \text{V to } \pm 15\ \text{V}, V_O = 0, R_S = 50\ \Omega$	25°C	70	100		dB
$I_{CC}$	Supply current	$V_O = 0, \text{ No load}$	25°C		1.4	2.5	mA
$V_{O1}/V_{O2}$	Crosstalk attenuation	$A_{VD} = 100$	25°C		120		dB

† All characteristics are measured under open-loop conditions with zero common-mode voltage unless otherwise specified. Full range for  $T_A$  is  $-40^\circ\text{C}$  to  $85^\circ\text{C}$ .

‡ Input bias currents of a FET-input operational amplifier are normal junction reverse currents, which are temperature sensitive as shown in Figure 5. Pulse techniques must be used that will maintain the junction temperature as close to the ambient temperature as possible.

### operating characteristics, $V_{CC\pm} = \pm 15\ \text{V}, T_A = 25^\circ\text{C}$

PARAMETER		TEST CONDITIONS		MIN	TYP	MAX	UNIT
SR	Slew rate at unity gain	$V_I = 10\ \text{V},$	$R_L = 2\ \text{k}\Omega, C_L = 100\ \text{pF},$ See Figure 1	8	13		$\text{V}/\mu\text{s}$
$t_r$	Rise-time overshoot factor	$V_I = 20\ \text{mV},$	$R_L = 2\ \text{k}\Omega, C_L = 100\ \text{pF},$ See Figure 1		0.1		$\mu\text{s}$
					20		%
$V_n$	Equivalent input noise voltage	$R_S = 20\ \Omega$	$f = 1\ \text{kHz}$		18		$\text{nV}/\sqrt{\text{Hz}}$
			$f = 10\ \text{Hz to } 10\ \text{kHz}$		4		$\mu\text{V}$
$I_n$	Equivalent input noise current	$R_S = 20\ \Omega,$	$f = 1\ \text{kHz}$		0.01		$\text{pA}/\sqrt{\text{Hz}}$
THD	Total harmonic distortion	$V_{O(rms)} = 10\ \text{V},$	$R_S \leq 1\ \text{k}\Omega, R_L \geq 2\ \text{k}\Omega, f = 1\ \text{kHz}$		0.003		%



**APPLICATION INFORMATION**

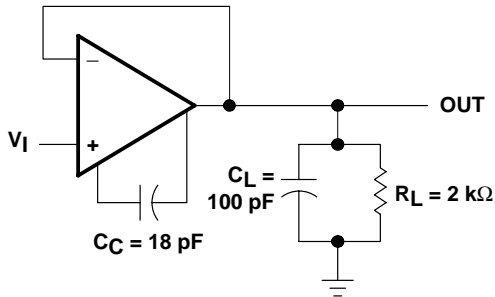

**Figure 1. Unity-Gain Amplifier**

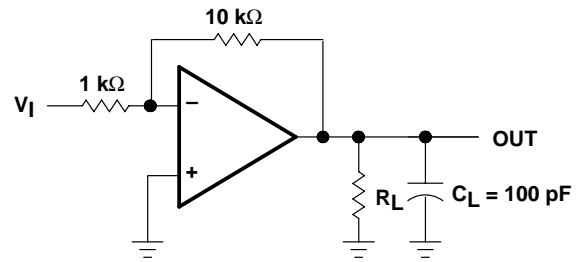

**Figure 2. Gain-of-10 Inverting Amplifier**

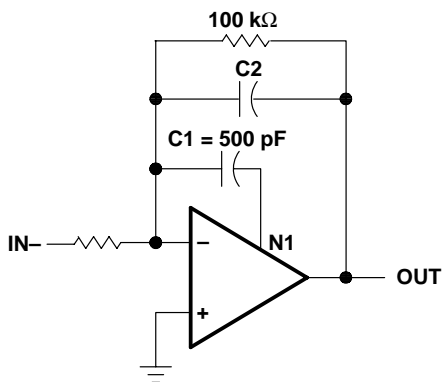

**Figure 3. Feed-Forward Compensation**

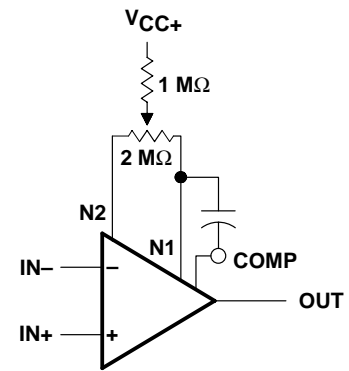

**Figure 4. Input Offset Voltage Null Circuit**

# TL070

## JFET-INPUT OPERATIONAL AMPLIFIER

SLOS121B – NOVEMBER 1993 – REVISED MARCH 2001

---

### TYPICAL CHARACTERISTICS

Table of Graphs

	FIGURE
Input bias current vs Free-air temperature	5
Maximum peak output voltage vs Frequency	6, 7, 8
Maximum peak output voltage vs Free-air temperature	9
Maximum peak output voltage vs Load resistance	10
Maximum peak output voltage vs Supply voltage	11
Large-signal differential voltage amplification vs Free-air temperature	12
Differential voltage amplification vs Frequency with feed-forward compensation	13
Large-signal differential voltage amplification and phase shift vs Frequency	14
Normalized unity-gain bandwidth and phase shift vs Free-air temperature	15
Common-mode rejection ratio vs Free-air temperature	16
Supply current vs Supply voltage	17
Supply current vs Free-air temperature	18
Total power dissipated vs Free-air temperature	19
Normalized slew rate vs Free-air temperature	20
Equivalent input noise voltage vs Frequency	21
Total harmonic distortion vs Frequency	22
Voltage-follower large-signal pulse response	23
Output voltage vs Elapsed time	24



POST OFFICE BOX 655303 • DALLAS, TEXAS 75265

TYPICAL CHARACTERISTICS†

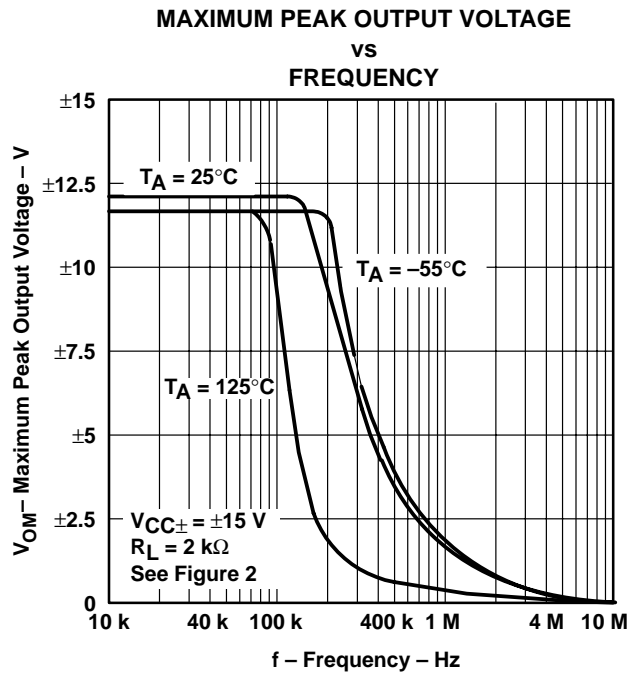
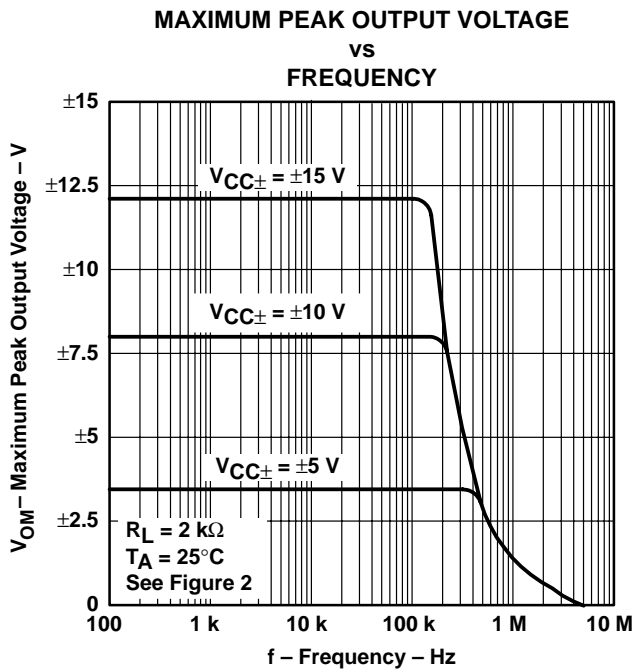
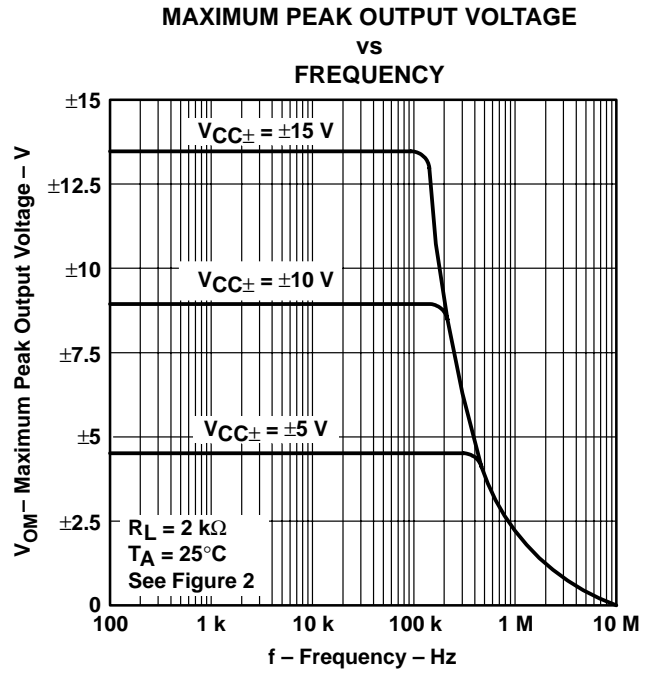
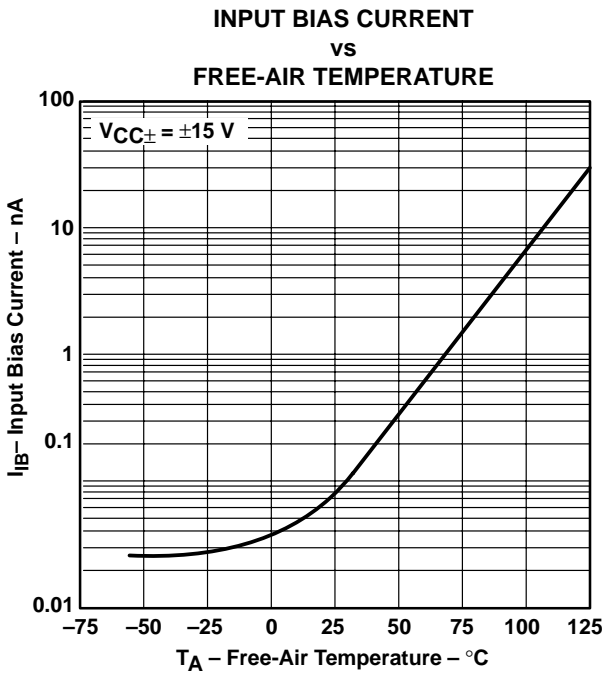

† Data at high and low temperatures are applicable only within the rated operating free-air temperature ranges of the various devices. An 18-pF compensation capacitor is used.

# TL070 JFET-INPUT OPERATIONAL AMPLIFIER

SLOS121B – NOVEMBER 1993 – REVISED MARCH 2001

## TYPICAL CHARACTERISTICS†

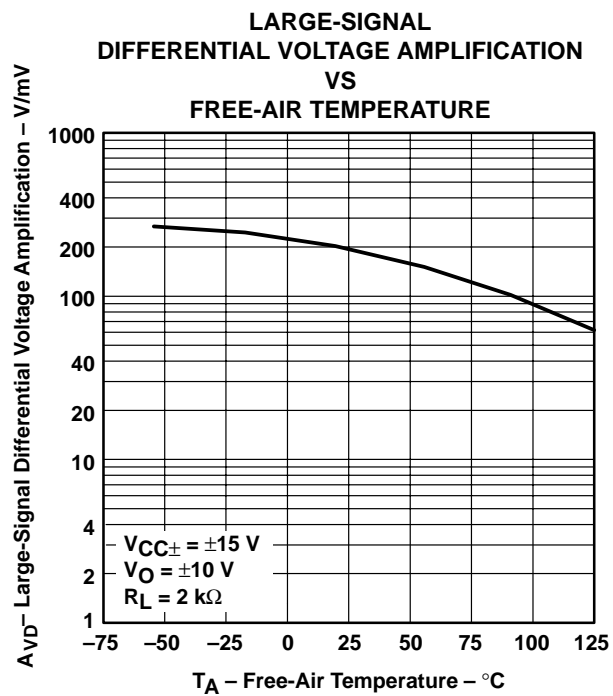
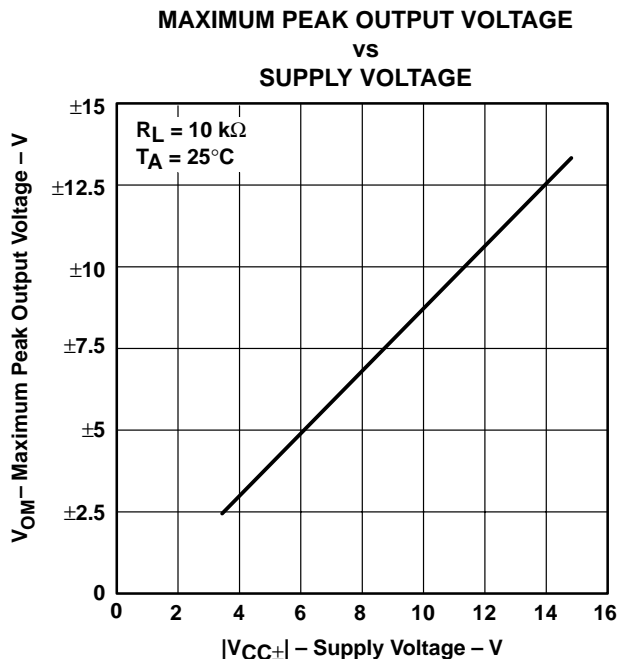
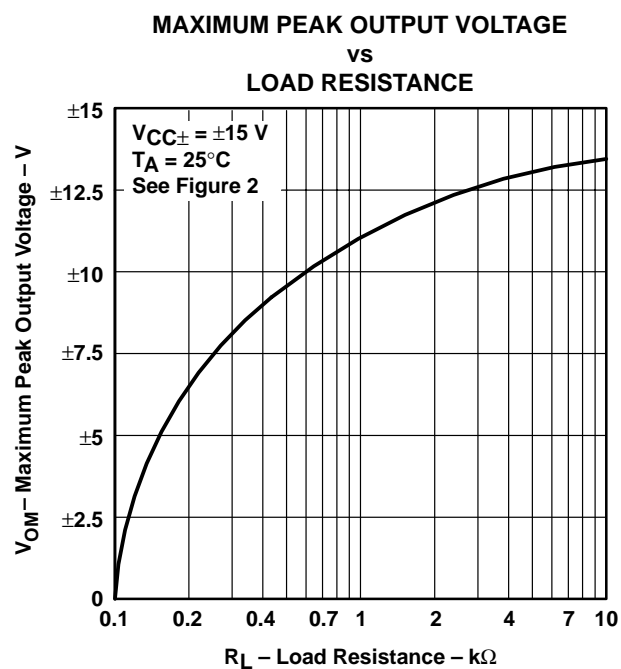
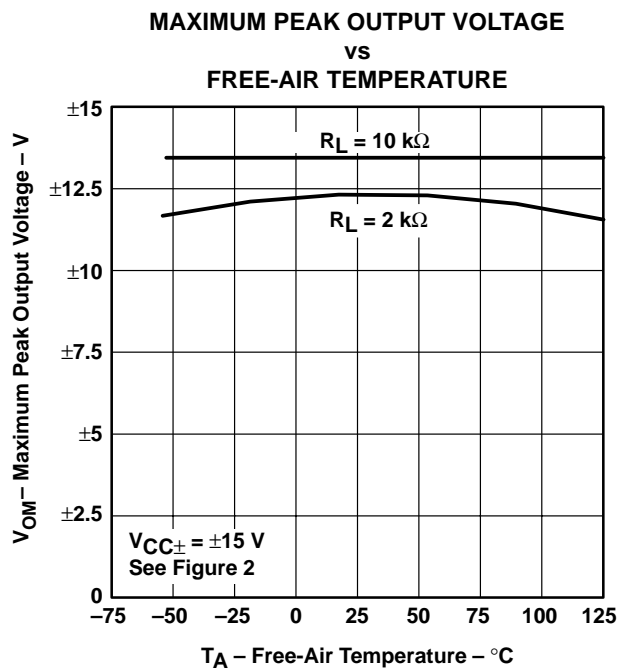

† Data at high and low temperatures are applicable only within the rated operating free-air temperature ranges of the various devices. An 18-pF compensation capacitor is used.



TYPICAL CHARACTERISTICS†

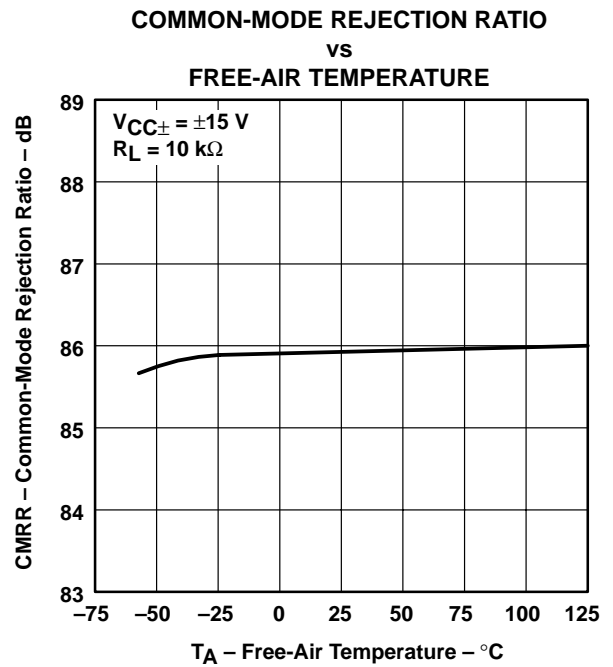
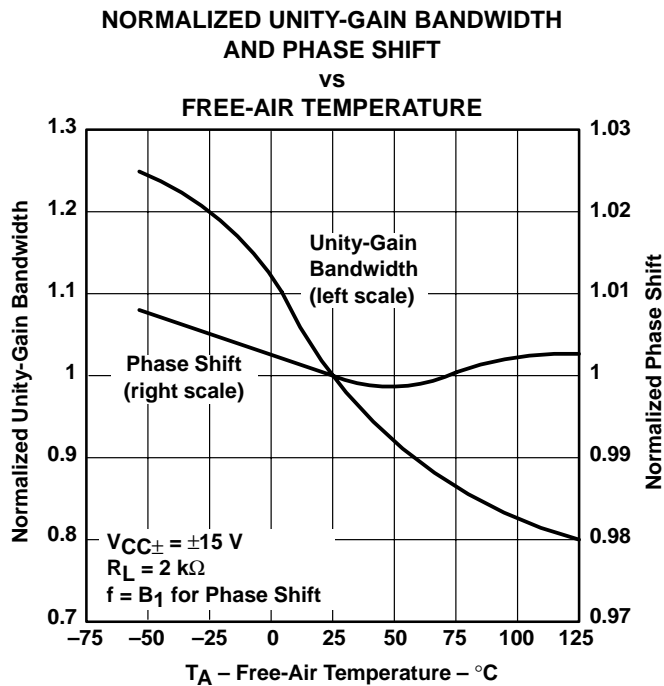
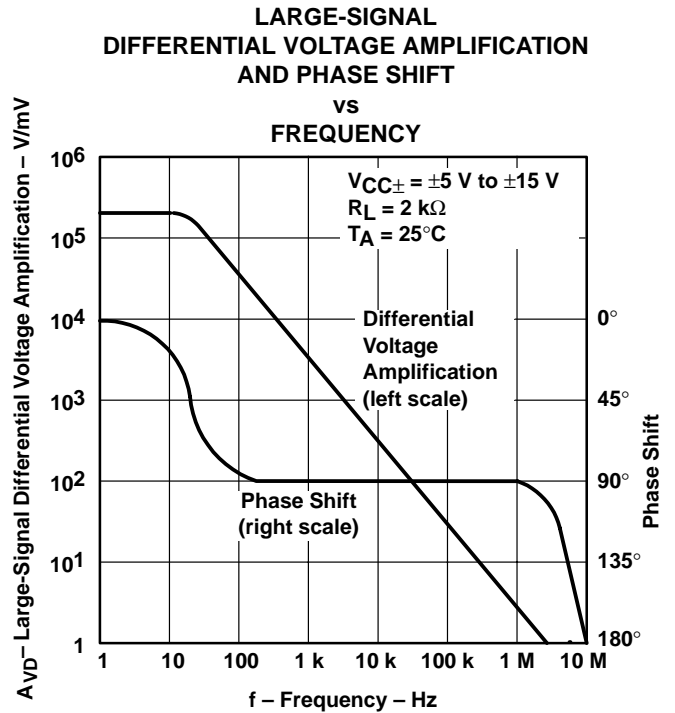
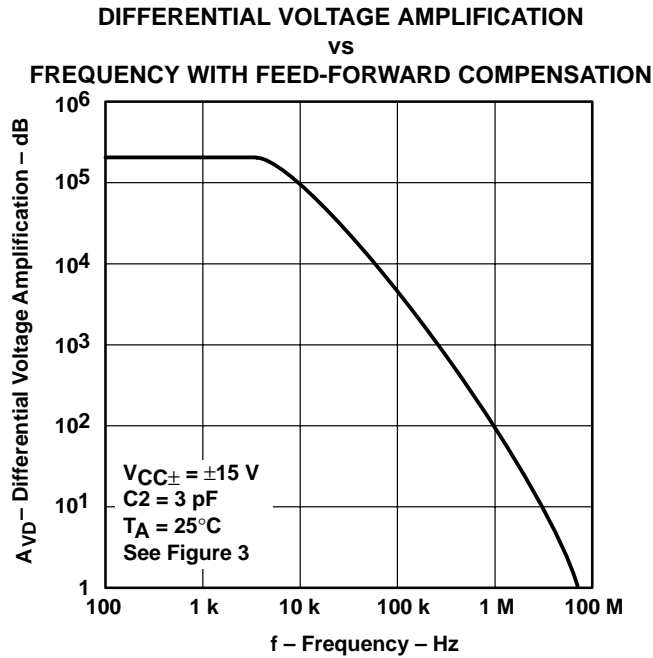

† Data at high and low temperatures are applicable only within the rated operating free-air temperature ranges of the various devices. An 18-pF compensation capacitor is used.

# TL070 JFET-INPUT OPERATIONAL AMPLIFIER

SLOS121B – NOVEMBER 1993 – REVISED MARCH 2001

## TYPICAL CHARACTERISTICS†

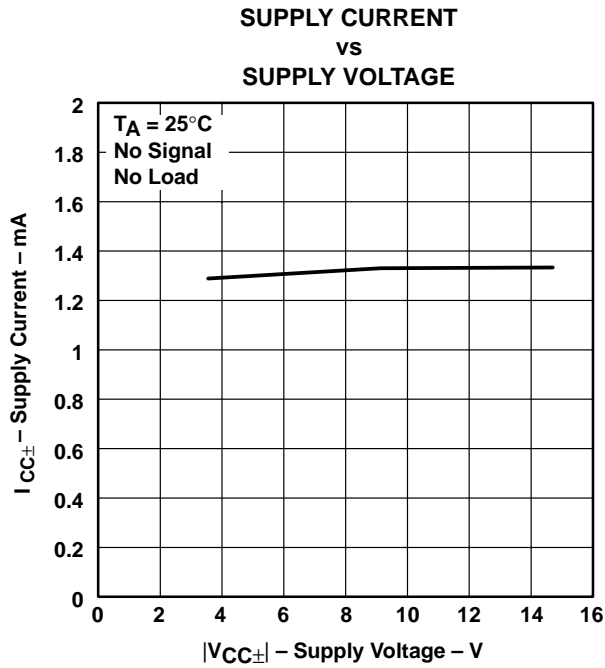

Figure 17

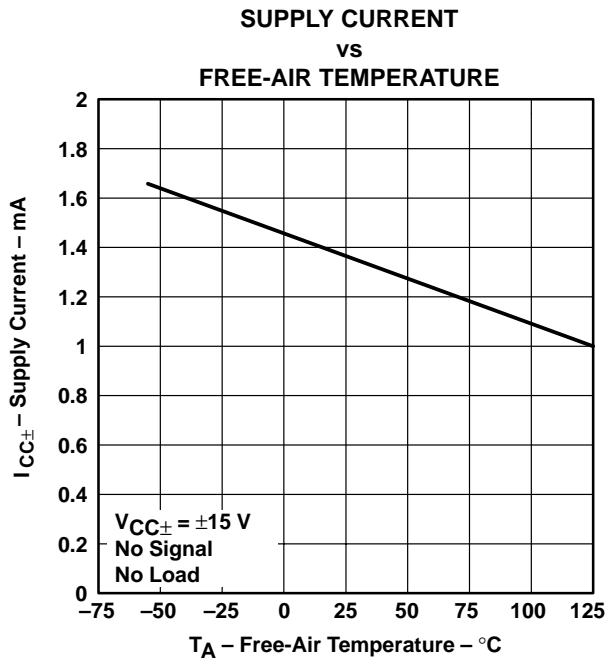

Figure 18

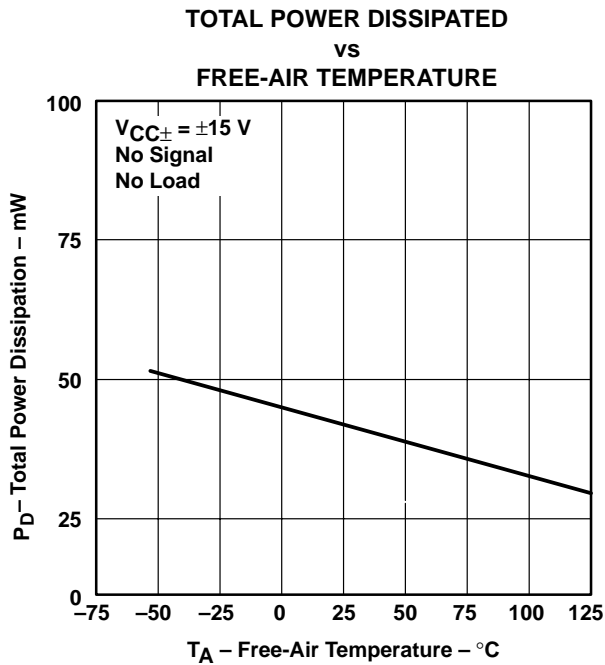

Figure 19

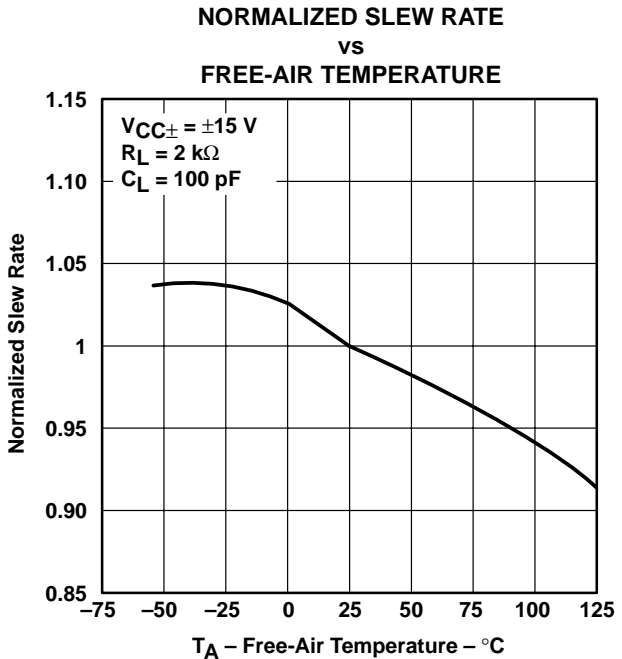

Figure 20

† Data at high and low temperatures are applicable only within the rated operating free-air temperature ranges of the various devices. An 18-pF compensation capacitor is used.

TYPICAL CHARACTERISTICS

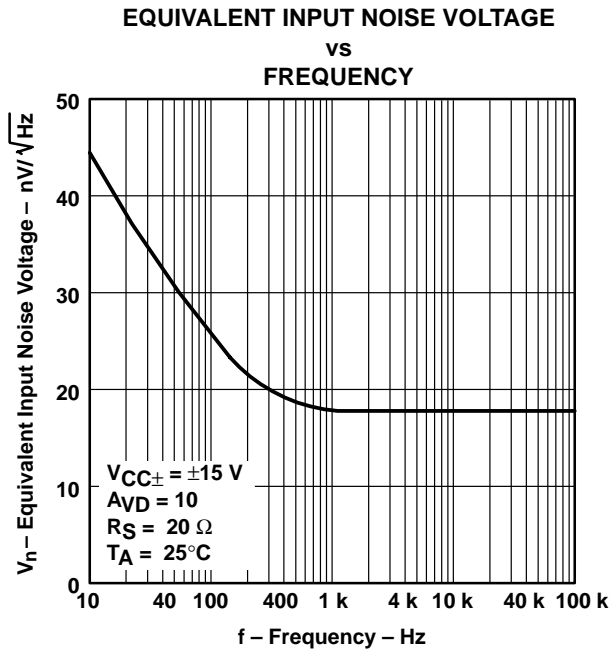

Figure 21

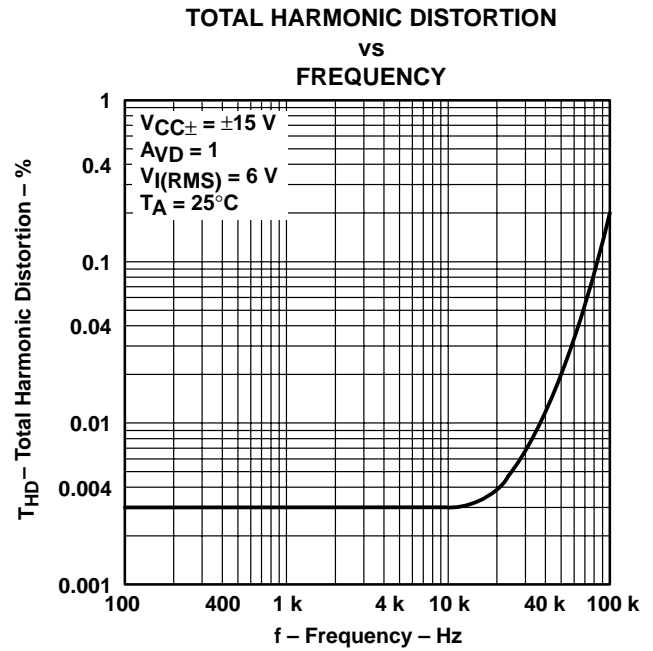

Figure 22

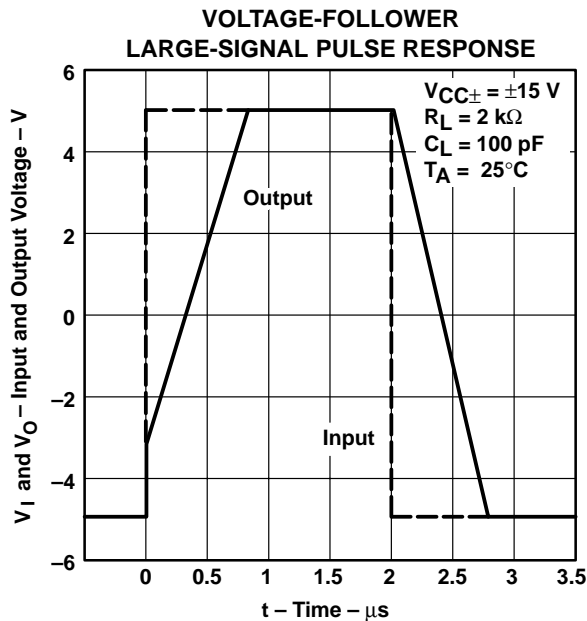

Figure 23

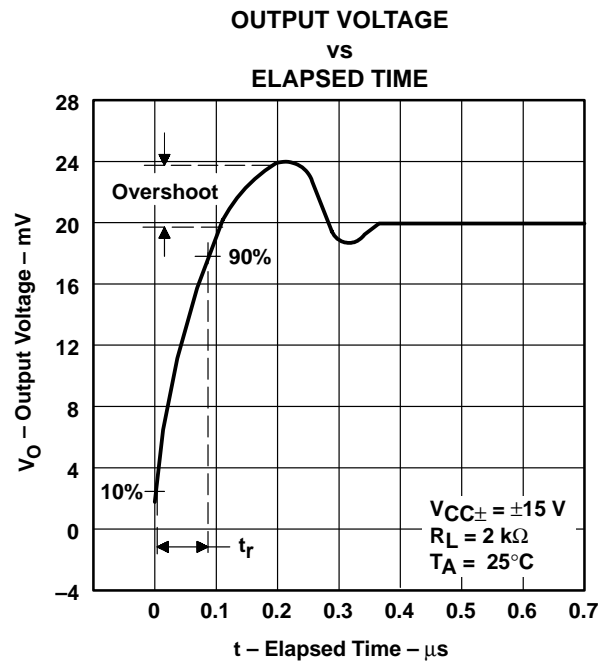

Figure 24

# TL070 JFET-INPUT OPERATIONAL AMPLIFIER

SLOS121B – NOVEMBER 1993 – REVISED MARCH 2001

## APPLICATION INFORMATION

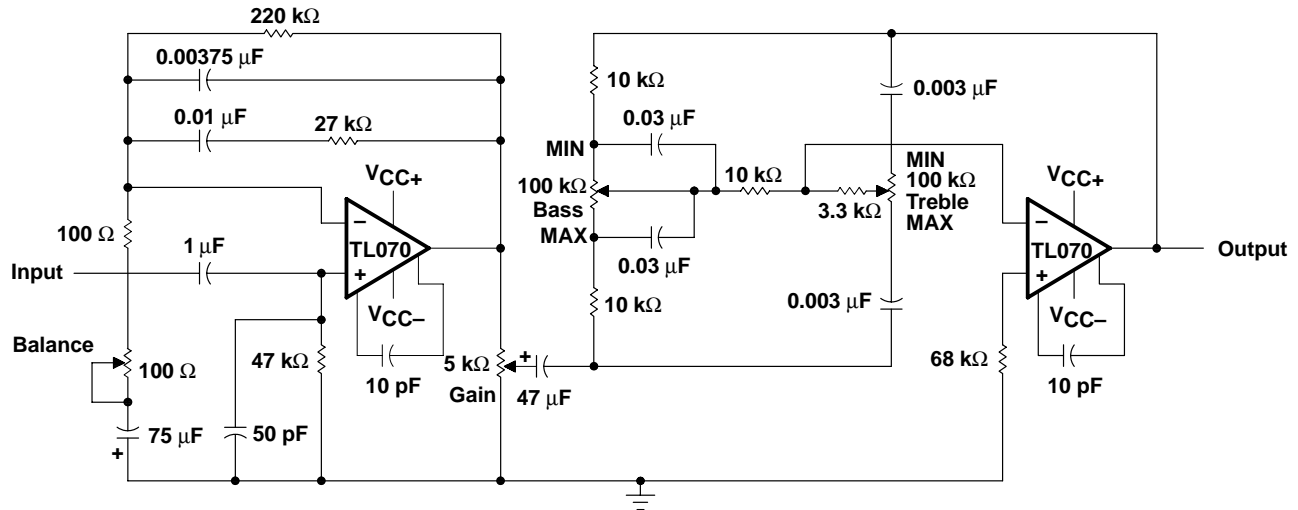

Figure 25. IC Preamplifier

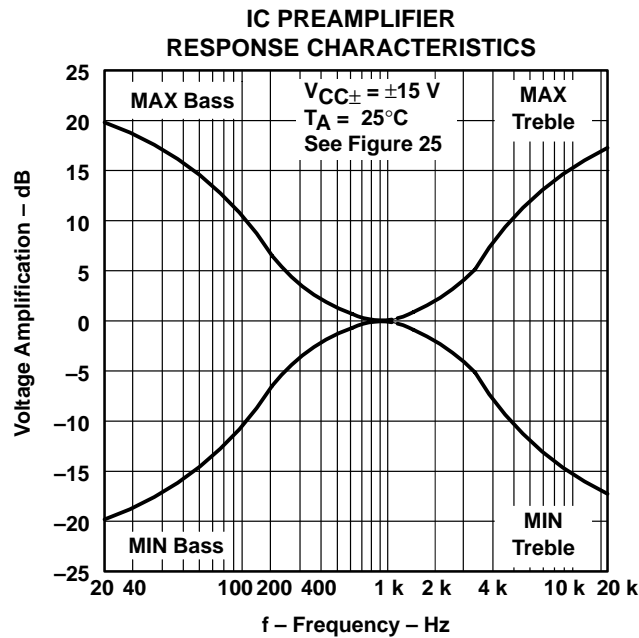

Figure 26

**PACKAGING INFORMATION**

Orderable Device	Status <sup>(1)</sup>	Package Type	Package Drawing	Pins	Package Qty	Eco Plan <sup>(2)</sup>	Lead/ Ball Finish	MSL Peak Temp <sup>(3)</sup>	Samples (Requires Login)
TL070CD	OBSOLETE	SOIC	D	8		TBD	Call TI	Call TI	Samples Not Available
TL070CP	OBSOLETE	PDIP	P	8		TBD	Call TI	Call TI	Samples Not Available
TL070IP	OBSOLETE	PDIP	P	8		TBD	Call TI	Call TI	Samples Not Available

<sup>(1)</sup> The marketing status values are defined as follows:

**ACTIVE:** Product device recommended for new designs.

**LIFEBUY:** TI has announced that the device will be discontinued, and a lifetime-buy period is in effect.

**NRND:** Not recommended for new designs. Device is in production to support existing customers, but TI does not recommend using this part in a new design.

**PREVIEW:** Device has been announced but is not in production. Samples may or may not be available.

**OBSOLETE:** TI has discontinued the production of the device.

<sup>(2)</sup> Eco Plan - The planned eco-friendly classification: Pb-Free (RoHS), Pb-Free (RoHS Exempt), or Green (RoHS & no Sb/Br) - please check <http://www.ti.com/productcontent> for the latest availability information and additional product content details.

**TBD:** The Pb-Free/Green conversion plan has not been defined.

**Pb-Free (RoHS):** TI's terms "Lead-Free" or "Pb-Free" mean semiconductor products that are compatible with the current RoHS requirements for all 6 substances, including the requirement that lead not exceed 0.1% by weight in homogeneous materials. Where designed to be soldered at high temperatures, TI Pb-Free products are suitable for use in specified lead-free processes.

**Pb-Free (RoHS Exempt):** This component has a RoHS exemption for either 1) lead-based flip-chip solder bumps used between the die and package, or 2) lead-based die adhesive used between the die and leadframe. The component is otherwise considered Pb-Free (RoHS compatible) as defined above.

**Green (RoHS & no Sb/Br):** TI defines "Green" to mean Pb-Free (RoHS compatible), and free of Bromine (Br) and Antimony (Sb) based flame retardants (Br or Sb do not exceed 0.1% by weight in homogeneous material)

<sup>(3)</sup> MSL, Peak Temp. -- The Moisture Sensitivity Level rating according to the JEDEC industry standard classifications, and peak solder temperature.

**Important Information and Disclaimer:** The information provided on this page represents TI's knowledge and belief as of the date that it is provided. TI bases its knowledge and belief on information provided by third parties, and makes no representation or warranty as to the accuracy of such information. Efforts are underway to better integrate information from third parties. TI has taken and continues to take reasonable steps to provide representative and accurate information but may not have conducted destructive testing or chemical analysis on incoming materials and chemicals. TI and TI suppliers consider certain information to be proprietary, and thus CAS numbers and other limited information may not be available for release.

In no event shall TI's liability arising out of such information exceed the total purchase price of the TI part(s) at issue in this document sold by TI to Customer on an annual basis.

P (R-PDIP-T8)

PLASTIC DUAL-IN-LINE PACKAGE



- NOTES:
- A. All linear dimensions are in inches (millimeters).
  - B. This drawing is subject to change without notice.
  - C. Falls within JEDEC MS-001 variation BA.

D (R-PDSO-G8)

PLASTIC SMALL OUTLINE



- NOTES:
- A. All linear dimensions are in inches (millimeters).
  - B. This drawing is subject to change without notice.
  - Body length does not include mold flash, protrusions, or gate burrs. Mold flash, protrusions, or gate burrs shall not exceed 0.006 (0,15) each side.
  - Body width does not include interlead flash. Interlead flash shall not exceed 0.017 (0,43) each side.
  - E. Reference JEDEC MS-012 variation AA.

## IMPORTANT NOTICE

Texas Instruments Incorporated and its subsidiaries (TI) reserve the right to make corrections, modifications, enhancements, improvements, and other changes to its products and services at any time and to discontinue any product or service without notice. Customers should obtain the latest relevant information before placing orders and should verify that such information is current and complete. All products are sold subject to TI's terms and conditions of sale supplied at the time of order acknowledgment.

TI warrants performance of its hardware products to the specifications applicable at the time of sale in accordance with TI's standard warranty. Testing and other quality control techniques are used to the extent TI deems necessary to support this warranty. Except where mandated by government requirements, testing of all parameters of each product is not necessarily performed.

TI assumes no liability for applications assistance or customer product design. Customers are responsible for their products and applications using TI components. To minimize the risks associated with customer products and applications, customers should provide adequate design and operating safeguards.

TI does not warrant or represent that any license, either express or implied, is granted under any TI patent right, copyright, mask work right, or other TI intellectual property right relating to any combination, machine, or process in which TI products or services are used. Information published by TI regarding third-party products or services does not constitute a license from TI to use such products or services or a warranty or endorsement thereof. Use of such information may require a license from a third party under the patents or other intellectual property of the third party, or a license from TI under the patents or other intellectual property of TI.

Reproduction of TI information in TI data books or data sheets is permissible only if reproduction is without alteration and is accompanied by all associated warranties, conditions, limitations, and notices. Reproduction of this information with alteration is an unfair and deceptive business practice. TI is not responsible or liable for such altered documentation. Information of third parties may be subject to additional restrictions.

Resale of TI products or services with statements different from or beyond the parameters stated by TI for that product or service voids all express and any implied warranties for the associated TI product or service and is an unfair and deceptive business practice. TI is not responsible or liable for any such statements.

TI products are not authorized for use in safety-critical applications (such as life support) where a failure of the TI product would reasonably be expected to cause severe personal injury or death, unless officers of the parties have executed an agreement specifically governing such use. Buyers represent that they have all necessary expertise in the safety and regulatory ramifications of their applications, and acknowledge and agree that they are solely responsible for all legal, regulatory and safety-related requirements concerning their products and any use of TI products in such safety-critical applications, notwithstanding any applications-related information or support that may be provided by TI. Further, Buyers must fully indemnify TI and its representatives against any damages arising out of the use of TI products in such safety-critical applications.

TI products are neither designed nor intended for use in military/aerospace applications or environments unless the TI products are specifically designated by TI as military-grade or "enhanced plastic." Only products designated by TI as military-grade meet military specifications. Buyers acknowledge and agree that any such use of TI products which TI has not designated as military-grade is solely at the Buyer's risk, and that they are solely responsible for compliance with all legal and regulatory requirements in connection with such use.

TI products are neither designed nor intended for use in automotive applications or environments unless the specific TI products are designated by TI as compliant with ISO/TS 16949 requirements. Buyers acknowledge and agree that, if they use any non-designated products in automotive applications, TI will not be responsible for any failure to meet such requirements.

Following are URLs where you can obtain information on other Texas Instruments products and application solutions:

### Products

Audio	<a href="http://www.ti.com/audio">www.ti.com/audio</a>
Amplifiers	<a href="http://amplifier.ti.com">amplifier.ti.com</a>
Data Converters	<a href="http://dataconverter.ti.com">dataconverter.ti.com</a>
DLP® Products	<a href="http://www.dlp.com">www.dlp.com</a>
DSP	<a href="http://dsp.ti.com">dsp.ti.com</a>
Clocks and Timers	<a href="http://www.ti.com/clocks">www.ti.com/clocks</a>
Interface	<a href="http://interface.ti.com">interface.ti.com</a>
Logic	<a href="http://logic.ti.com">logic.ti.com</a>
Power Mgmt	<a href="http://power.ti.com">power.ti.com</a>
Microcontrollers	<a href="http://microcontroller.ti.com">microcontroller.ti.com</a>
RFID	<a href="http://www.ti-rfid.com">www.ti-rfid.com</a>
RF/IF and ZigBee® Solutions	<a href="http://www.ti.com/lprf">www.ti.com/lprf</a>

### Applications

Communications and Telecom	<a href="http://www.ti.com/communications">www.ti.com/communications</a>
Computers and Peripherals	<a href="http://www.ti.com/computers">www.ti.com/computers</a>
Consumer Electronics	<a href="http://www.ti.com/consumer-apps">www.ti.com/consumer-apps</a>
Energy and Lighting	<a href="http://www.ti.com/energy">www.ti.com/energy</a>
Industrial	<a href="http://www.ti.com/industrial">www.ti.com/industrial</a>
Medical	<a href="http://www.ti.com/medical">www.ti.com/medical</a>
Security	<a href="http://www.ti.com/security">www.ti.com/security</a>
Space, Avionics and Defense	<a href="http://www.ti.com/space-avionics-defense">www.ti.com/space-avionics-defense</a>
Transportation and Automotive	<a href="http://www.ti.com/automotive">www.ti.com/automotive</a>
Video and Imaging	<a href="http://www.ti.com/video">www.ti.com/video</a>
Wireless	<a href="http://www.ti.com/wireless-apps">www.ti.com/wireless-apps</a>

TI E2E Community Home Page

[e2e.ti.com](http://e2e.ti.com)

Mailing Address: Texas Instruments, Post Office Box 655303, Dallas, Texas 75265  
Copyright © 2011, Texas Instruments Incorporated