

2-W FILTERLESS MONO CLASS-D AUDIO POWER AMPLIFIER

FEATURES

- Modulation Scheme Optimized to Operate Without a Filter
- 4 mm × 4 mm MicroStar Junior BGA and TSSOP Package Options
- 2 W Into a 4-Ω Speaker (THD+N<1%)
- <0.2% THD+N at 1.5 W, 1 kHz, Into a 4-Ω Load
- Extremely Efficient Third Generation 5-V Class-D Technology:
 - Low-Supply Current (No Filter): 4 mA
 - Low-Supply Current (Filter): 7.5 mA
 - Low-Shutdown Current: 0.05 μA
 - Low-Noise Floor: 40 μV_{RMS} (No-Weighting Filter)
 - Maximum Efficiency Into 8 Ω, 75 - 85 %
 - 4 Internal Gain Settings: 6 to 23.5 dB
 - PSRR: -77 dB
- Integrated Depop Circuitry
- Short-Circuit Protection (Short to Battery, Ground, and Load)

APPLICATIONS

- High-Efficiency For Extended Battery Run Time

DESCRIPTION

The TPA2000D1 is a 2-W mono bridge-tied-load (BTL) class-D amplifier designed to drive a speaker with at least 4-Ω impedance. The amplifier uses TI's third generation modulation technique, which results in improved efficiency and SNR. It also allows the device to be connected directly to the speaker without the use of the LC output filter commonly associated with class-D amplifiers (this results in EMI that must be shielded at the system level). These features make the device ideal for use in devices where high efficiency is needed to extend battery run time.

The gain of the amplifier is controlled by two input terminals, GAIN1 and GAIN0. This allows the amplifier to be configured for a gain of 6, 12, 18, and 23.5 dB. The differential input terminals are high-impedance CMOS inputs, and can be used as summing nodes.

The class-D BTL amplifier includes depop circuitry to reduce the amount of turnon pop at power up and when cycling **SHUTDOWN**.

The TPA2000D1 is available in the 16-pin TSSOP and MicroStar Junior™ BGA packages that drive 2 W of continuous output power into a 4-Ω load. TPA2000D1 operates over an ambient temperature range of -40°C to 85°C.

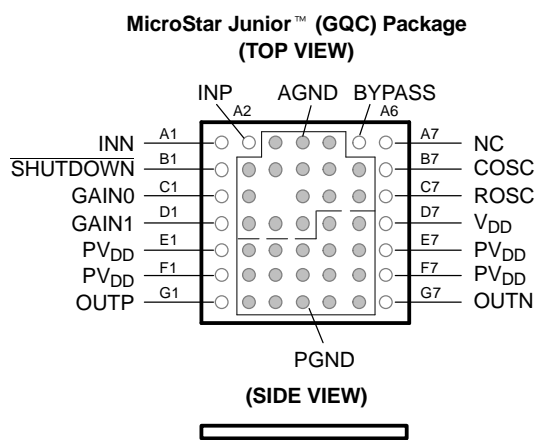
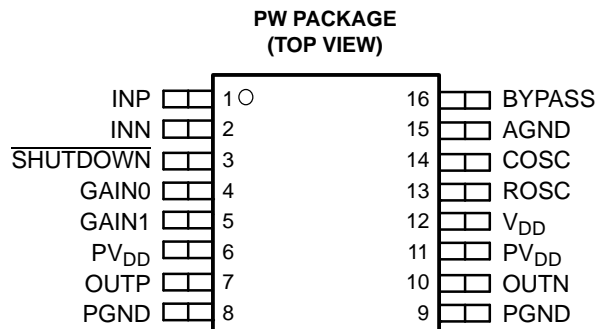

NC – No internal connection, still requires a pad for the ball.
NOTE: The shaded terminals are used for thermal connections to the ground plane.



Please be aware that an important notice concerning availability, standard warranty, and use in critical applications of Texas Instruments semiconductor products and disclaimers thereto appears at the end of this data sheet.

MicroStar Junior is a trademark of Texas Instruments.



This integrated circuit can be damaged by ESD. Texas Instruments recommends that all integrated circuits be handled with appropriate precautions. Failure to observe proper handling and installation procedures can cause damage.

ESD damage can range from subtle performance degradation to complete device failure. Precision integrated circuits may be more susceptible to damage because very small parametric changes could cause the device not to meet its published specifications.

AVAILABLE OPTIONS

T _A	PACKAGED DEVICES	
	TSSOP (PW) ⁽¹⁾	GQC ⁽²⁾
40°C to 85°C	TPA2000D1PW	TPA2000D1GQCR

- (1) The PW package is available taped and reeled. To order a taped and reeled part, add the suffix R to the part number (e.g., TPA2000D1PWR).
- (2) The GQC package is only available taped and reeled.

FUNCTIONAL BLOCK DIAGRAM

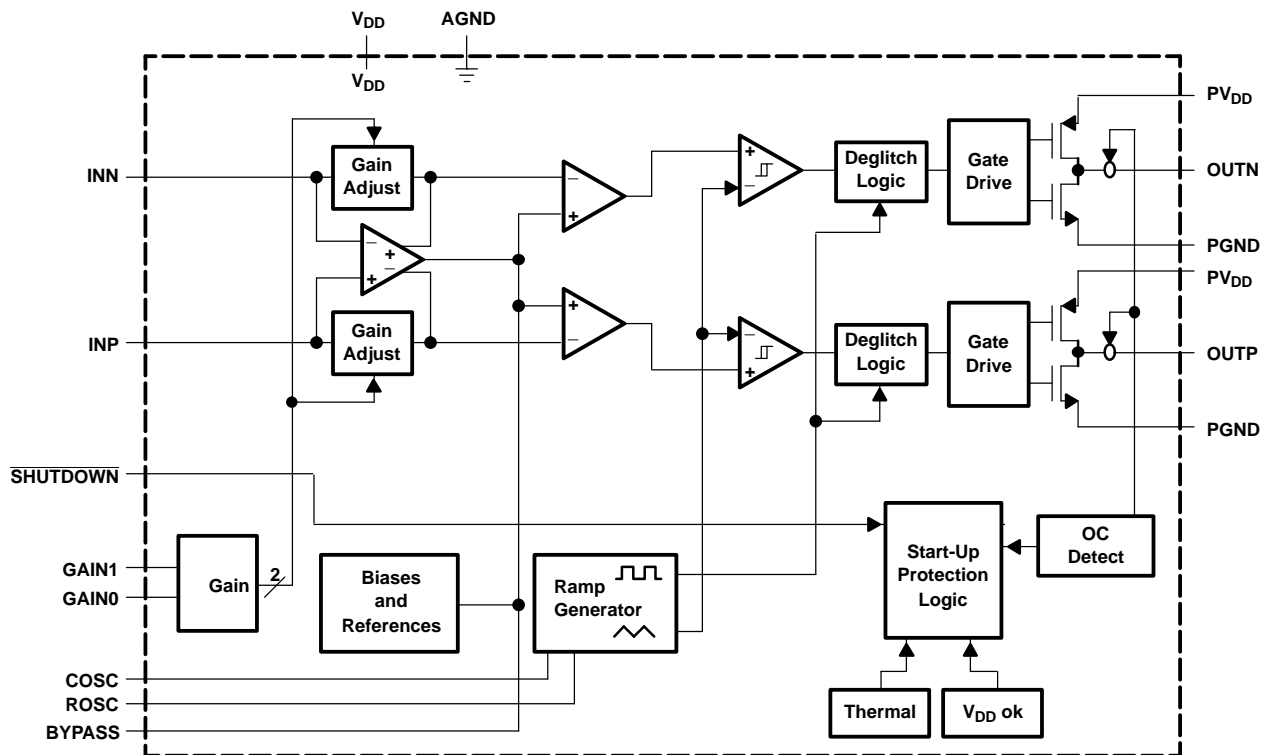

TERMINAL FUNCTIONS

TERMINAL			I/O	DESCRIPTION
NAME	NO.			
	GQC	PW		
AGND	A3 - A5, B2 - B6 C2 - C6 D2 - D4	15	I	Analog ground
BYPASS	A6	16	I	Connect capacitor to ground for BYPASS voltage filtering.
COSC	B7	14	I	Connect capacitor to ground to set oscillation frequency.
GAIN0	C1	4	I	Bit 0 of gain control (TTL logic level)
GAIN1	D1	5	I	Bit 1 of gain control (TTL logic level)
INN	A1	2	I	Negative differential input
INP	A2	1	I	Positive differential input
OUTN	G7	10	O	Negative BTL output
OUTP	G1	7	O	Positive BTL output
PGND	D5, D6 E2 - E6 F2 - F6 G2 - G6	8, 9	I	High-current grounds
PV _{DD}	E1, E7, F1, F7	6, 11	I	High-current power supplies
ROSC	C7	13	I	Connect resistor to ground to set oscillation frequency.
SHUTDOWN	B1	3	I	Places the amplifier in shutdown mode if a TTL logic low is placed on this terminal, and normal operation if a TTL logic high is placed on this terminal.
V _{DD}	D7	12	I	Analog power supply

ABSOLUTE MAXIMUM RATINGS

over operating free-air temperature range (unless otherwise noted)⁽¹⁾

		UNITS
Supply voltage	V _{DD} , PV _{DD}	-0.3 V to 5.5 V
Input voltage, V _I		-0.3 V to V _{DD} +0.3 V
Continuous total power dissipation		(See Dissipation Rating Table)
Operating free-air temperature range, T _A		-40°C to 85°C
Operating junction temperature range, T _J		-40°C to 150°C
Storage temperature range, T _{stg}		-65°C to 150°C
Lead temperature 1, 6 mm (1/16 inch) from case for 10 seconds		260°C

- (1) Stresses beyond those listed under "absolute maximum ratings" may cause permanent damage to the device. These are stress ratings only, and functional operation of the device at these or any other conditions beyond those indicated under "recommended operating conditions" is not implied. Exposure to absolute-maximum-rated conditions for extended periods may affect device reliability.

DISSIPATION RATING TABLE

PACKAGE	T _A ≤ 25°C	DERATING FACTOR	T _A = 70°C	T _A = 85°C
PW	774 mW	6.19 mW/°C	495 mW	402 mW
GQC	2.61 W	20.9 mW/°C	1.67 W	1.36 W

RECOMMENDED OPERATING CONDITIONS

			MIN	MAX	UNIT
V_{DD}, PV_{DD}	Supply voltage		2.7	5.5	V
V_{IH}	High-level input voltage	GAIN0, GAIN1, SHUTDOWN	2		V
V_{IL}	Low-level input voltage	GAIN0, GAIN1, SHUTDOWN		0.7	V
f_s	Switching frequency		200	300	kHz
T_A	Operating free-air temperature		-40	85	°C

ELECTRICAL CHARACTERISTICSat specified free-air temperature, $PV_{DD} = V_{DD} = 5\text{ V}$, $T_A = 25^\circ\text{C}$ (unless otherwise noted)

PARAMETER	TEST CONDITIONS	MIN	TYP	MAX	UNIT
$ V_{OS} $	Output offset voltage (measured differentially) $V_I = 0\text{ V}$, $A_V = \text{any gain}$			25	mV
PSRR	Power supply rejection ratio $PV_{DD} = 4.9\text{ V to } 5.1\text{ V}$		-77		dB
$ I_{IH} $	High-level input current $PV_{DD} = 5.5$, $V_I = PV_{DD}$			1	μA
$ I_{IL} $	Low-level input current $PV_{DD} = 5.5$, $V_I = 0\text{ V}$			1	μA
I_{DD}	Supply current, no filter (with or without speaker load)		4	6	mA
$I_{DD(SD)}$	Supply current, shutdown mode GAIN0, GAIN1, SHUTDOWN = 0 V		0.05	20	μA

OPERATING CHARACTERISTICS $PV_{DD} = V_{DD} = 5\text{ V}$, $T_A = 25^\circ\text{C}$, $R_L = 4\ \Omega$, gain = 6 dB (unless otherwise noted)

PARAMETER	TEST CONDITIONS	MIN	TYP	MAX	UNIT
P_O	Output power THD = 1%, $f = 1\text{ kHz}$,		2		W
THD + N	Total harmonic distortion plus noise $P_O = 1.5\text{ W}$, $f = 20\text{ Hz to } 20\text{ kHz}$		<0.2%		
k_{SVR}	Supply ripple rejection ratio $f = 1\text{ kHz}$, $C_{BYP} = 1\ \mu\text{F}$		-67		dB
SNR	Signal-to-noise ratio		95		dB
V_n	Output noise voltage (no-noise weighting filter) $C_{BYP} = 1\ \mu\text{F}$, $f = < 10\text{ Hz to } 22\text{ kHz}$		40		$\mu\text{V(rms)}$
Z_i	Input impedance		>15		k Ω

ELECTRICAL CHARACTERISTICSat specified free-air temperature, $PV_{DD} = V_{DD} = 3.3\text{ V}$, $T_A = 25^\circ\text{C}$ (unless otherwise noted)

PARAMETER	TEST CONDITIONS	MIN	TYP	MAX	UNIT
$ V_{OS} $	Output offset voltage (measured differentially) $V_I = 0\text{ V}$, $A_V = \text{any gain}$			25	mV
PSRR	Power supply rejection ratio $PV_{DD} = 3.2\text{ V to } 3.4\text{ V}$		-61		dB
$ I_{IH} $	High-level input current $PV_{DD} = 3.3$, $V_I = PV_{DD}$			1	μA
$ I_{IL} $	Low-level input current $PV_{DD} = 3.3$, $V_I = 0\text{ V}$			1	μA
I_{DD}	Supply current, no filter (with or without speaker load)		4	6	mA
$I_{DD(SD)}$	Supply current, shutdown mode		0.05	20	μA

OPERATING CHARACTERISTICS
 $P_{V_{DD}} = V_{DD} = 3.3\text{ V}$, $T_A = 25^\circ\text{C}$, $R_L = 4\ \Omega$, gain = 6 dB (unless otherwise noted)

PARAMETER		TEST CONDITIONS	MIN	TYP	MAX	UNIT
P_O	Output power	THD = 1%, $f = 1\text{ kHz}$		850		mW
THD + N	Total harmonic distortion plus noise	$P_O = 55\text{ mW}$, $f = 20\text{ Hz to }20\text{ kHz}$		<0.2%		
k_{SVR}	Supply ripple rejection ratio	$f = 1\text{ kHz}$, $C_{BYP} = 1\ \mu\text{F}$		-61		dB
SNR	Signal-to-noise ratio			93		dB
V_n	Output noise voltage (no-noise weighting filter)	$C_{BYP} = 1\ \mu\text{F}$, $f = <10\text{ Hz to }22\text{ kHz}$		40		$\mu\text{V}(\text{rms})$
Z_i	Input impedance			>15		$\text{k}\Omega$

Table 1. GAIN SETTINGS

GAIN1	GAIN0	AMPLIFIER GAIN (dB)	INPUT IMPEDANCE ($\text{k}\Omega$)
		TYP	TYP
0	0	6	104
0	1	12	74
1	0	18	44
1	1	23.5	24

TYPICAL CHARACTERISTICS

TABLE OF GRAPHS

			FIGURE
η	Efficiency	vs Output power	1
	FFT at 1.5-W output power	vs Frequency	2
THD+N	Total harmonic distortion plus noise	vs Output power	3, 4, 5
		vs Frequency	6, 7
$k_{(SRR)}$	Supply ripple rejection ratio	vs Frequency	8

TEST SETUP FOR GRAPHS

The THD+N measurements shown do not use an LC output filter, but do use a 100- Ω , 0.047- μ F RC low-pass filter with a cutoff frequency of ~30 kHz before the audio analyzer so the switching frequency does not dominate the measurement. This is done to ensure that the THD+N measured is just the audible THD+N. The THD+N measurements are shown at the highest gain for worst case. The efficiency was measured with no filters, and a 3- Ω , 4- Ω , or 8- Ω resistor in series with a 33- μ H inductor as the load.

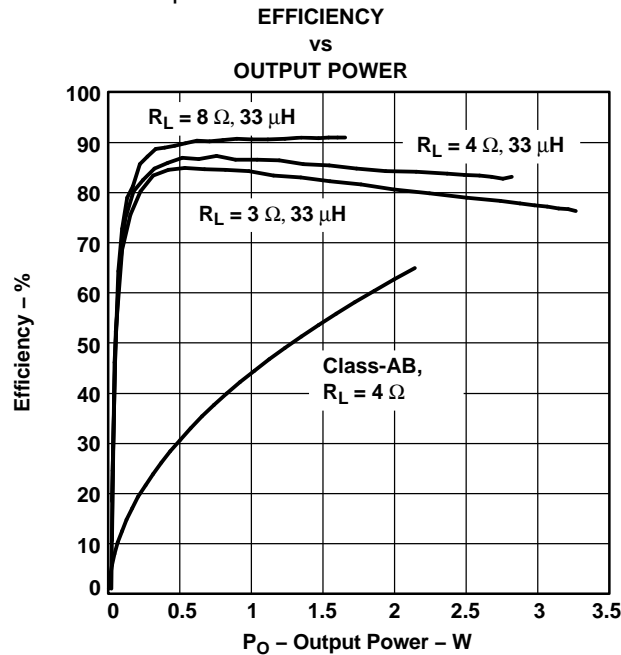

Figure 1.

TYPICAL CHARACTERISTICS (continued)

**FFT AT 1.5-W OUTPUT POWER
 vs
 FREQUENCY**

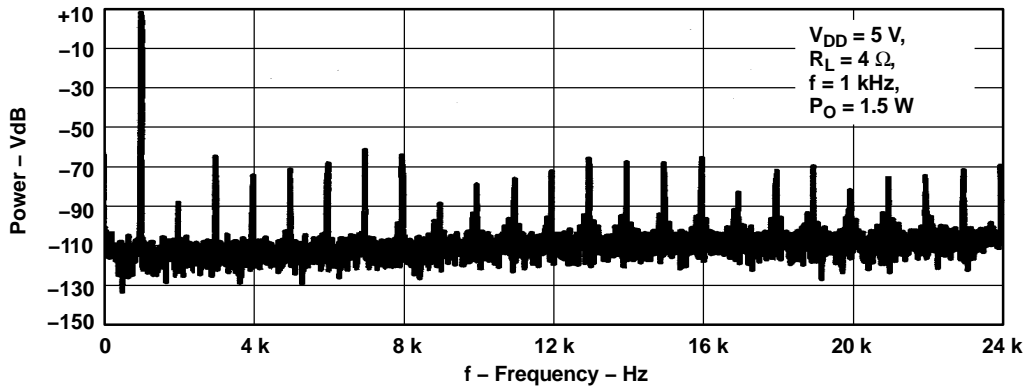

Figure 2.

**TOTAL HARMONIC DISTORTION PLUS NOISE
 vs
 OUTPUT POWER**

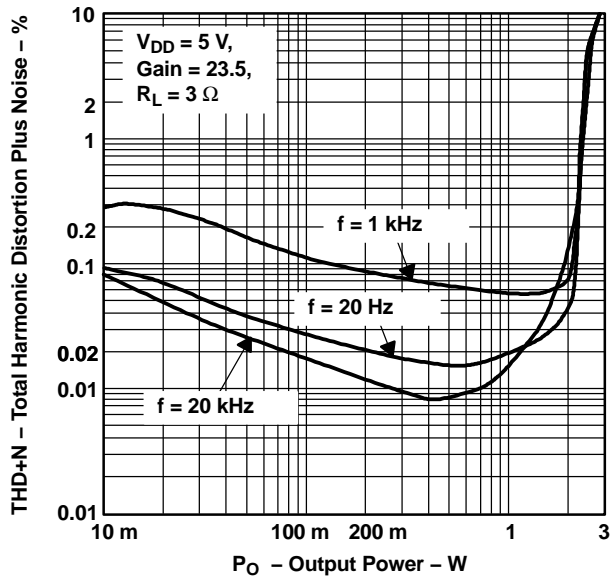

Figure 3.

**TOTAL HARMONIC DISTORTION PLUS NOISE
 vs
 OUTPUT POWER**

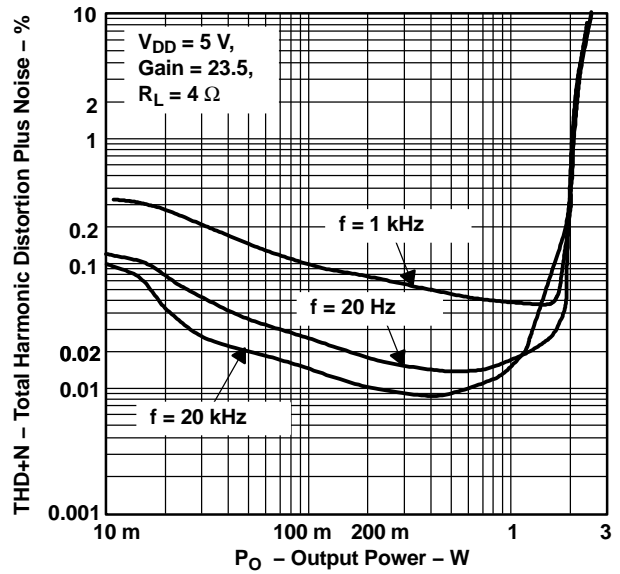

Figure 4.

TYPICAL CHARACTERISTICS (continued)

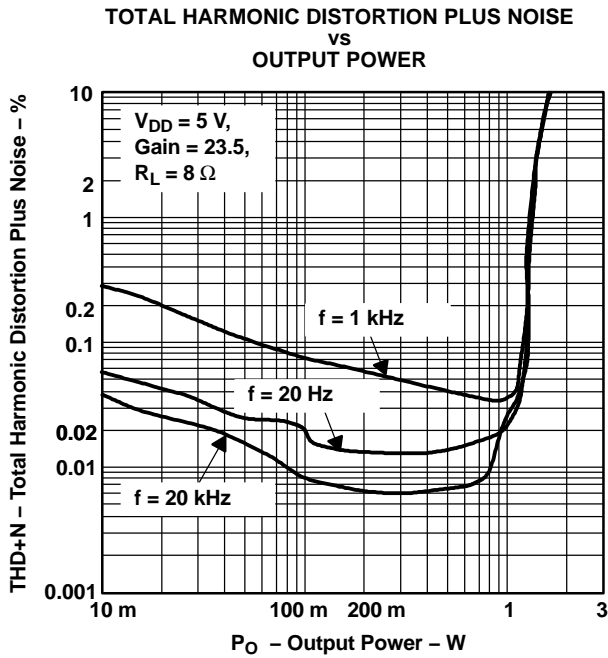

Figure 5.

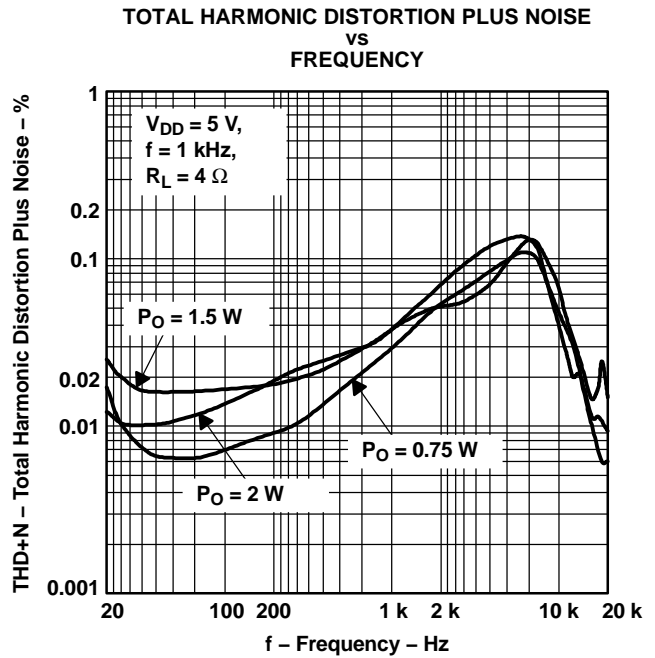

Figure 6.

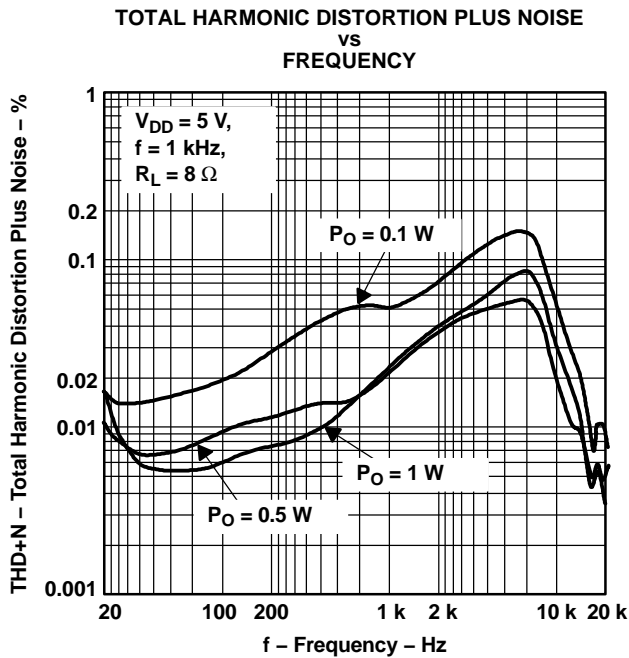

Figure 7.

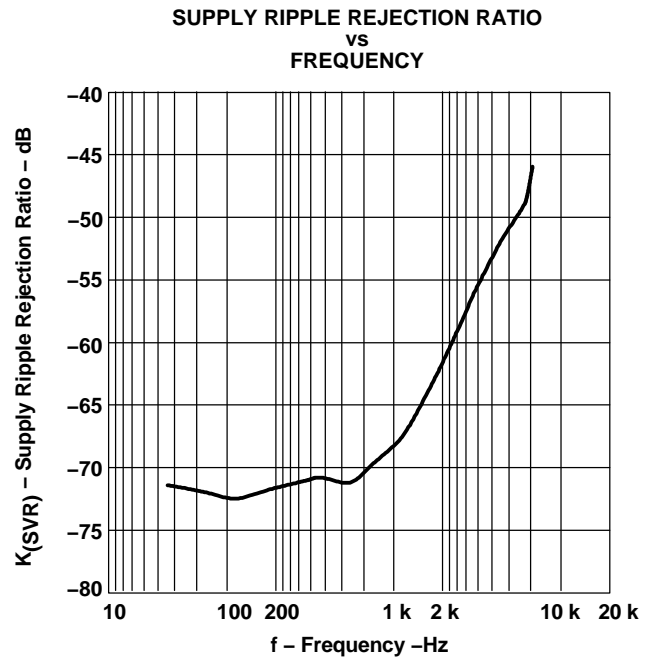

Figure 8.

APPLICATION INFORMATION

ELIMINATING THE OUTPUT FILTER WITH THE TPA2000D1

This section explains why the user can eliminate the output filter with the TPA2000D1.

EFFECT ON AUDIO

The class-D amplifier outputs a pulse-width modulated (PWM) square wave, which is the sum of the switching waveform and the amplified input audio signal. The human ear acts as a band-pass filter such that only the frequencies between approximately 20 Hz and 20 kHz are passed. The switching frequency components are much greater than 20 kHz, so the only signal heard is the amplified input audio signal.

TRADITIONAL CLASS-D MODULATION SCHEME

The traditional class-D modulation scheme, which is used in the TPA005Dxx family, has a differential output where each output is 180 degrees out of phase and changes from ground to the supply voltage, V_{DD} . Therefore, the differential prefiltered output varies between positive and negative V_{DD} , where filtered 50% duty cycle yields 0 V across the load. The traditional class-D modulation scheme with voltage and current waveforms is shown in Figure 9. Even at an average of 0 V across the load (50% duty cycle), the current to the load is high, causing high loss, and a high supply current.

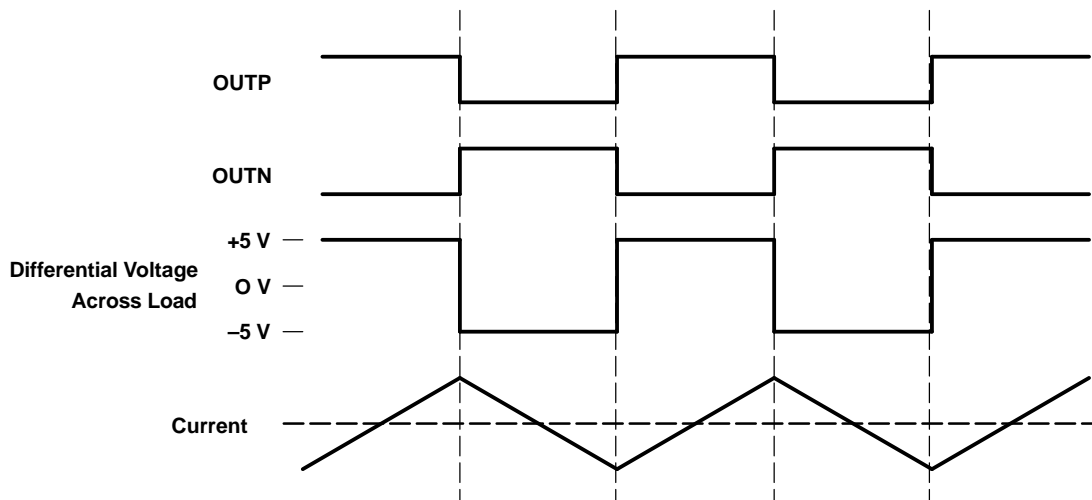

Figure 9. Traditional Class-D Modulation Scheme Output Voltage and Current Waveforms Into an Inductive Load With No Input

TPA2000D1 MODULATION SCHEME

The TPA2000D1 uses a modulation scheme that still has each output switching from 0 to the supply voltage. However, OUTP and OUTN are now in phase with each other with no input. The duty cycle of OUTP is greater than 50% and OUTN is less than 50% for positive voltages. The duty cycle of OUTP is less than 50% and OUTN is greater than 50% for negative voltages. The voltage across the load sits at 0 V throughout most of the switching period greatly reducing the switching current, which reduces any I^2R losses in the load.

APPLICATION INFORMATION (continued)

Figure 10. The TPA2000D1 Output Voltage and Current Waveforms Into an Inductive Load

EFFICIENCY: WHY YOU MUST USE A FILTER WITH THE TRADITIONAL CLASS-D MODULATION SCHEME

The main reason that the traditional class-D amplifier needs an output filter is that the switching waveform results in maximum current flow. This causes more loss in the load, which causes lower efficiency. The ripple current is large for the traditional modulation scheme because the ripple current is proportional to voltage multiplied by the time at that voltage. The differential voltage swing is $2 \times V_{DD}$ and the time at each voltage is half the period for the traditional modulation scheme. An ideal LC filter is needed to store the ripple current from each half cycle for the next half cycle, while any resistance causes power dissipation. The speaker is both resistive and reactive, whereas an LC filter is almost purely reactive.

The TPA2000D1 modulation scheme has little loss in the load without a filter because the pulses are short and the change in voltage is V_{DD} instead of $2 \times V_{DD}$. As the output power increases, the pulses widen making the ripple current larger. Ripple current could be filtered with an LC filter for increased efficiency, but for most applications the filter is not needed.

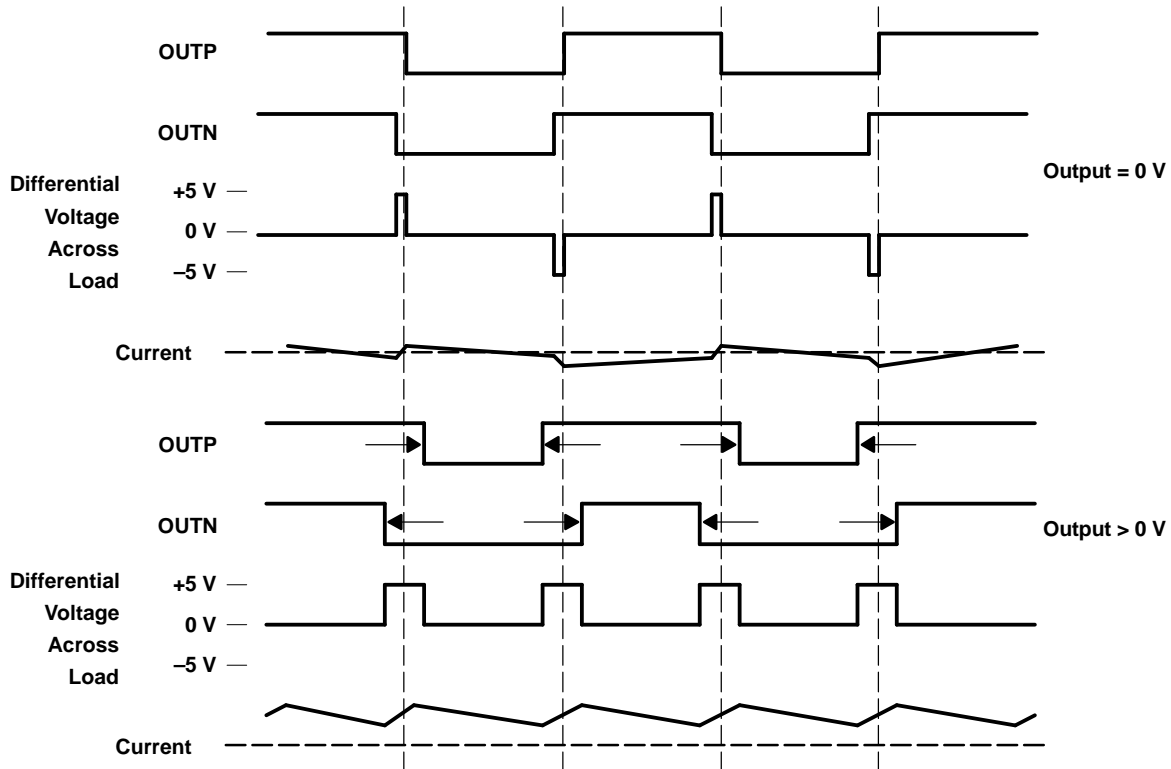
An LC filter with a cutoff frequency less than the class-D switching frequency allows the switching current to flow through the filter instead of the load. The filter has less resistance than the speaker that results in less power dissipated, which increases efficiency.

APPLICATION INFORMATION (continued)

EFFECTS OF APPLYING A SQUARE WAVE INTO A SPEAKER

Audio specialists advise not to apply a square wave to speakers. If the amplitude of the waveform is high enough and the frequency of the square wave is within the bandwidth of the speaker, the square wave could cause the voice coil to jump out of the air gap and/or scar the voice coil. A 250-kHz switching frequency, however, is not significant because the speaker cone movement is proportional to $1/f^2$ for frequencies beyond the audio band. Therefore, the amount of cone movement at the switching frequency is very small. However, damage could occur to the speaker if the voice coil is not designed to handle the additional power. To size the speaker for added power, the ripple current dissipated in the load needs to be calculated by subtracting the theoretical supplied power ($P_{SUP\ THEORETICAL}$) from the actual supply power (P_{SUP}) at maximum output power (P_{OUT}). The switching power dissipated in the speaker is the inverse of the measured efficiency ($\eta_{MEASURED}$) minus the theoretical efficiency ($\eta_{THEORETICAL}$) all multiplied by P_{OUT} .

$$P_{SPKR} = P_{SUP} - P_{SUP\ THEORETICAL} \text{ (at max output power)} \quad (1)$$

$$P_{SPKR} = P_{OUT}(P_{SUP} / P_{OUT} - P_{SUP\ THEORETICAL} / P_{OUT}) \text{ (at max output power)} \quad (2)$$

$$P_{SPKR} = P_{OUT}(1/\eta_{MEASURED} - 1/\eta_{THEORETICAL}) \text{ (at max output power)} \quad (3)$$

The maximum efficiency of the TPA2000D1 with an 8- Ω load is 85%. Using Equation 3 with the efficiency at maximum power (78%), we see that there is an additional 106 mW dissipated in the speaker. The added power dissipated in the speaker is not an issue as long as it is taken into account when choosing the speaker.

WHEN TO USE AN OUTPUT FILTER

Design the TPA2000D1 without the filter if the traces from amplifier to speaker are short. The TPA2000D1 passed FCC and CE radiated emissions with no shielding with speaker wires eight inches long or less. Notebook PCs and powered speakers where the speaker is in the same enclosure as the amplifier are good applications for class-D without a filter.

A ferrite bead filter (shown in Figure 11) can often be used if the design is failing radiated emissions without a filter, and the frequency sensitive circuit is greater than 1 MHz. This is good for circuits that just have to pass FCC and CE because FCC and CE only test radiated emissions greater than 30 MHz. If choosing a ferrite bead, choose one with high impedance at high frequencies, but low impedance at low frequencies.

Use an LC output filter if there are low frequency (<1 MHz) EMI sensitive circuits and/or there are long leads from amplifier to speaker.

The LC output filter is shown in Figure 11.

- $L1 = L2 = 22\ \mu\text{H}$ (DCR = 110 m Ω , part number = SCD0703T-220 M-S, manufacturer = GCI)
- $C1 = C2 = 1\ \mu\text{F}$

The ferrite filter is shown in Figure 11, where L is a ferrite bead.

- $L1 = L2 =$ ferrite bead (part number = MPZ1608S221, manufacturer = TDK)
- $C1 = C2 = 1\ \text{nF}$

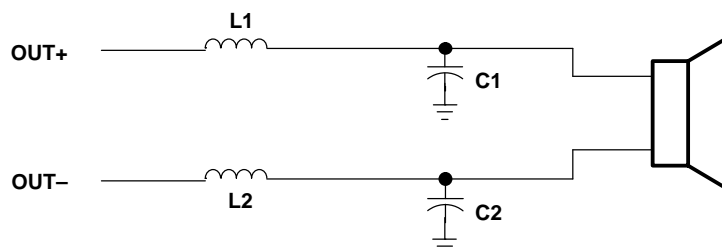

Figure 11. Class-D Output Filter

APPLICATION INFORMATION (continued)

GAIN SETTING VIA GAIN0 AND GAIN1 INPUTS

The gain of the TPA2000D1 is set by two input terminals, GAIN0 and GAIN1.

The gains listed in Table 1 are realized by changing the taps on the input resistors inside the amplifier. This causes the input impedance (Z_i) to be dependent on the gain setting. The actual gain settings are controlled by ratios of resistors, so the actual gain distribution from part-to-part is quite good. However, the input impedance can shift by up to 30% due to shifts in the actual resistance of the input resistors.

For design purposes, the input network (discussed in the next section) should be designed assuming an input impedance of 20 k Ω , which is the absolute minimum input impedance of the TPA2000D1. At the higher gain settings, the input impedance can increase as high as 115 k Ω .

Table 2. GAIN SETTINGS

GAIN1	GAIN0	AMPLIFIER GAIN (dB)	INPUT IMPEDANCE (k Ω)
		TYP	TYP
0	0	6	104
0	1	12	74
1	0	18	44
1	1	23.5	24

INPUT RESISTANCE

Each gain setting is achieved by varying the input resistance of the amplifier, which can range from its smallest value to over six times that value. As a result, if a single capacitor is used in the input high-pass filter, the -3 dB or cutoff frequency also changes by over six times.

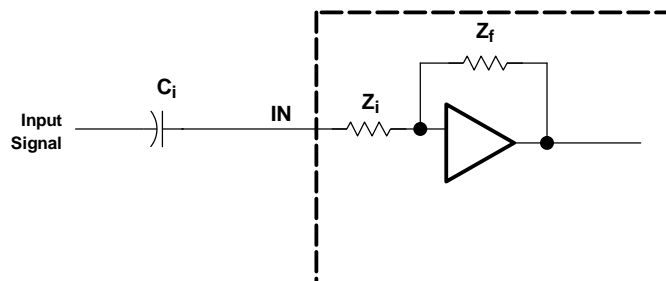

The -3-dB frequency can be calculated using Equation 4.

$$f_{-3\text{ dB}} = \frac{1}{2\pi C_i(Z_i)} \tag{4}$$

INPUT CAPACITOR, C_i

In the typical application an input capacitor (C_i) is required to allow the amplifier to bias the input signal to the proper dc level for optimum operation. In this case, C_i and the input impedance of the amplifier (Z_i) form a high-pass filter with the corner frequency determined in Equation 5.

$$f_c = \frac{1}{2\pi Z_i C_i}$$

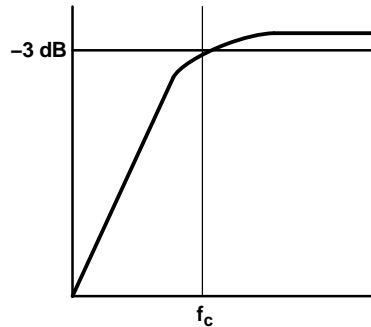

(5)

The value of C_i is important because it directly affects the bass (low frequency) performance of the circuit. Consider the example where Z_i is 20 k Ω and the specification calls for a flat bass response down to 80 Hz. Equation 5 is reconfigured as Equation 6.

$$C_i = \frac{1}{2\pi Z_i f_c}$$

(6)

In this example, C_i is 0.1 μ F, so one would likely choose a value in the range of 0.1 μ F to 1 μ F. If the gain is known and constant, use Z_i from Table 1 to calculate C_i . A further consideration for this capacitor is the leakage path from the input source through the input network (C_i) and the feedback network to the load. This leakage current creates a dc offset voltage at the input to the amplifier that reduces useful headroom, especially in high gain applications. For this reason, a low-leakage tantalum or ceramic capacitor is the best choice. When polarized capacitors are used, the positive side of the capacitor should face the amplifier input in most applications as the dc level there is held at $V_{DD}/2$, which is likely higher than the source dc level. It is important to confirm the capacitor polarity in the application.

C_i must be 10 times smaller than the bypass capacitor to reduce clicking and popping noise from power on/off and entering and leaving shutdown. After sizing C_i for a given cutoff frequency, size the bypass capacitor to 10 times that of the input capacitor.

$$C_i \leq \frac{C_{BYP}}{10}$$

(7)

POWER SUPPLY DECOUPLING, C_s

The TPA2000D1 is a high-performance CMOS audio amplifier that requires adequate power supply decoupling to ensure the output total harmonic distortion (THD) is as low as possible. Power supply decoupling also prevents oscillations for long lead lengths between the amplifier and the speaker. The optimum decoupling is achieved by using two capacitors of different types that target different types of noise on the power supply leads. For higher frequency transients, spikes, or digital hash on the line, a good low equivalent-series-resistance (ESR) ceramic capacitor, typically 0.1 μ F placed as close as possible to the device V_{DD} lead works best. For filtering lower-frequency noise signals, a larger aluminum electrolytic capacitor of 10 μ F or greater placed near the audio power amplifier is recommended.

MIDRAIL BYPASS CAPACITOR, C_{BYP}

The midrail bypass capacitor (C_{BYP}) is the most critical capacitor and serves several important functions. During start-up or recovery from shutdown mode, C_{BYP} determines the rate at which the amplifier starts up. The second function is to reduce noise produced by the power supply caused by coupling into the output drive signal. This noise is from the midrail generation circuit internal to the amplifier, which appears as degraded PSRR and THD+N.

Bypass capacitor (C_{BYP}) values of 0.47- μ F to 1- μ F ceramic or tantalum low-ESR capacitors are recommended for the best THD and noise performance.

Increasing the bypass capacitor reduces clicking and popping noise from power on/off and entering and leaving shutdown. To have minimal pop, C_{BYP} should be 10 times larger than C_i .

$$C_{BYP} \geq 10 \times C_i \quad (8)$$

DIFFERENTIAL INPUT

The differential input stage of the amplifier cancels any noise that appears on both input lines of the channel. To use the TPA2000D1 EVM with a differential source, connect the positive lead of the audio source to the INP input and the negative lead from the audio source to the INN input. To use the TPA2000D1 with a single-ended source, ac ground the INN input through a capacitor and apply the audio signal to the input. In a single-ended input application, the INN input should be ac-grounded at the audio source instead of at the device input for best noise performance.

SHUTDOWN MODES

The TPA2000D1 employs a shutdown mode of operation designed to reduce supply current (I_{DD}) to the absolute minimum level during periods of nonuse for battery-power conservation. The **SHUTDOWN** input terminal should be held high during normal operation when the amplifier is in use. Pulling **SHUTDOWN** low causes the outputs to mute and the amplifier to enter a low-current state, $I_{DD(SD)} = 1 \mu\text{A}$. **SHUTDOWN** should never be left unconnected because amplifier operation would be unpredictable.

USING LOW-ESR CAPACITORS

Low-ESR capacitors are recommended throughout this application section. A real (as opposed to ideal) capacitor can be modeled simply as a resistor in series with an ideal capacitor. The voltage drop across this resistor minimizes the beneficial effects of the capacitor in the circuit. The lower the equivalent value of this resistance, the more the real capacitor behaves like an ideal capacitor.

SWITCHING FREQUENCY

The switching frequency is determined using the values of the components connected to ROSC (pin 13) and COSC (pin 14) and are calculated using Equation 9.

$$f_s = \frac{6.6}{R_{OSC} \times C_{OSC}} \quad (9)$$

The switching frequency was chosen to be centered on 250 kHz. This frequency represents the optimization of audio fidelity due to oversampling and the maximization of efficiency by minimizing the switching losses of the amplifier.

The recommended values are a resistance of 120 kΩ and a capacitance of 220 pF. Using these component values, the amplifier operates properly by using 5% tolerance resistors and 10% tolerance capacitors. The tolerance of the components can be changed as long as the switching frequency remains between 200 kHz and 300 kHz. Within this range, the internal circuitry of the device provides stable operation.

APPLICATION CIRCUIT

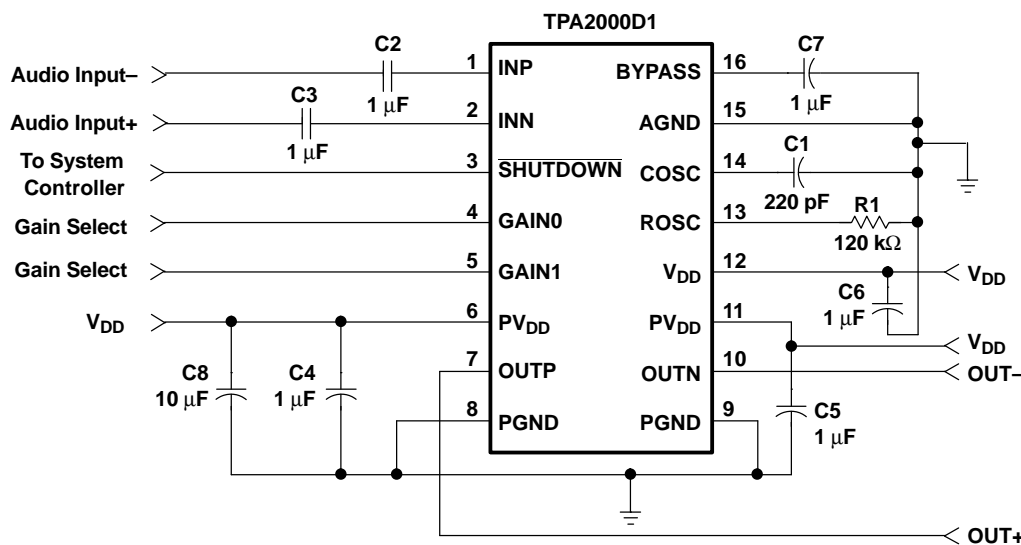

Table 3. TPA2000D1 APPLICATION CIRCUIT BILL OF MATERIALS

REFERENCE	DESCRIPTION	SIZE	QUANTITY	MANUFACTURER	PART NUMBER
C1	Capacitor, ceramic, 220 pF, ±10%, XICON, 50 V	0805	1	Mouser	140-CC501B221K
C2 - C7	Capacitor, ceramic, 1 μF, +80%/-20%, Y5V, 16 V	0805	6	Murata	GRM40-Y5V105Z16
C8	Capacitor, ceramic, 10 μF, +80%/-20%, Y5V, 16 V	1210	1	Murata	GRM235-Y5V106Z16
R1	Resistor, chip, 120 kΩ, 1/10 W, 5%, XICON	0805	1	Mouser	260-120K
U1	IC, TPA2000D1, audio power amplifier, 2-W, single channel, class-D	24-pin TSSOP	1	TI	TPA2000D1PW

LOW SUPPLY VOLTAGE POP

The TPA2000D1 pops when coming out of shutdown at low supply voltages (3.3 V and less) when using the application schematic shown above. The pops occur because the common-mode input range is worse at the lower supply voltages. At low supply voltages, the inputs are not within the common-mode input range when coming out of shutdown. The outputs develop an offset voltage until the inputs settle within the common-mode input range. This causes a pop. Figure 12 shows 1-M Ω resistors added to form voltage dividers. The voltage dividers bias the inputs to $V_{DD}/2$ that keeps the pop low at turn on and when coming out of shutdown. The resistors should be 1% tolerance to ensure the offset voltage is not increased.

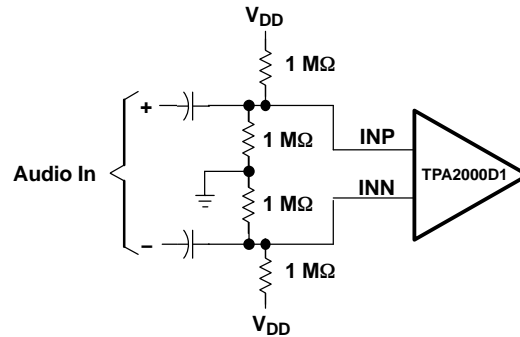







Figure 12. Voltage Dividers

PACKAGING INFORMATION

Orderable Device	Status (1)	Package Type	Package Drawing	Pins	Package Qty	Eco Plan (2)	Lead/Ball Finish	MSL Peak Temp (3)	Op Temp (°C)	Top-Side Markings (4)	Samples
TPA2000D1GQCR	ACTIVE	BGA MICROSTAR JUNIOR	GQC	48	2500	TBD	SNPB	Level-2-235C-1 YEAR	-40 to 85	2000D1	
TPA2000D1PW	ACTIVE	TSSOP	PW	16	90	Green (RoHS & no Sb/Br)	CU NIPDAU	Level-1-260C-UNLIM	-40 to 85	2000D1	
TPA2000D1PWG4	ACTIVE	TSSOP	PW	16	90	Green (RoHS & no Sb/Br)	CU NIPDAU	Level-1-260C-UNLIM	-40 to 85	2000D1	
TPA2000D1PWR	ACTIVE	TSSOP	PW	16	2000	Green (RoHS & no Sb/Br)	CU NIPDAU	Level-1-260C-UNLIM	-40 to 85	2000D1	
TPA2000D1PWRG4	ACTIVE	TSSOP	PW	16	2000	Green (RoHS & no Sb/Br)	CU NIPDAU	Level-1-260C-UNLIM	-40 to 85	2000D1	

(1) The marketing status values are defined as follows:

ACTIVE: Product device recommended for new designs.

LIFEBUY: TI has announced that the device will be discontinued, and a lifetime-buy period is in effect.

NRND: Not recommended for new designs. Device is in production to support existing customers, but TI does not recommend using this part in a new design.

PREVIEW: Device has been announced but is not in production. Samples may or may not be available.

OBSOLETE: TI has discontinued the production of the device.

(2) Eco Plan - The planned eco-friendly classification: Pb-Free (RoHS), Pb-Free (RoHS Exempt), or Green (RoHS & no Sb/Br) - please check <http://www.ti.com/productcontent> for the latest availability information and additional product content details.

TBD: The Pb-Free/Green conversion plan has not been defined.

Pb-Free (RoHS): TI's terms "Lead-Free" or "Pb-Free" mean semiconductor products that are compatible with the current RoHS requirements for all 6 substances, including the requirement that lead not exceed 0.1% by weight in homogeneous materials. Where designed to be soldered at high temperatures, TI Pb-Free products are suitable for use in specified lead-free processes.

Pb-Free (RoHS Exempt): This component has a RoHS exemption for either 1) lead-based flip-chip solder bumps used between the die and package, or 2) lead-based die adhesive used between the die and leadframe. The component is otherwise considered Pb-Free (RoHS compatible) as defined above.

Green (RoHS & no Sb/Br): TI defines "Green" to mean Pb-Free (RoHS compatible), and free of Bromine (Br) and Antimony (Sb) based flame retardants (Br or Sb do not exceed 0.1% by weight in homogeneous material)

(3) MSL, Peak Temp. -- The Moisture Sensitivity Level rating according to the JEDEC industry standard classifications, and peak solder temperature.

(4) Multiple Top-Side Markings will be inside parentheses. Only one Top-Side Marking contained in parentheses and separated by a "-" will appear on a device. If a line is indented then it is a continuation of the previous line and the two combined represent the entire Top-Side Marking for that device.

Important Information and Disclaimer: The information provided on this page represents TI's knowledge and belief as of the date that it is provided. TI bases its knowledge and belief on information provided by third parties, and makes no representation or warranty as to the accuracy of such information. Efforts are underway to better integrate information from third parties. TI has taken and

continues to take reasonable steps to provide representative and accurate information but may not have conducted destructive testing or chemical analysis on incoming materials and chemicals. TI and TI suppliers consider certain information to be proprietary, and thus CAS numbers and other limited information may not be available for release.

In no event shall TI's liability arising out of such information exceed the total purchase price of the TI part(s) at issue in this document sold by TI to Customer on an annual basis.

OTHER QUALIFIED VERSIONS OF TPA2000D1 :

- Automotive: [TPA2000D1-Q1](#)

NOTE: Qualified Version Definitions:

- Automotive - Q100 devices qualified for high-reliability automotive applications targeting zero defects

TAPE AND REEL INFORMATION



QUADRANT ASSIGNMENTS FOR PIN 1 ORIENTATION IN TAPE



*All dimensions are nominal

Device	Package Type	Package Drawing	Pins	SPQ	Reel Diameter (mm)	Reel Width W1 (mm)	A0 (mm)	B0 (mm)	K0 (mm)	P1 (mm)	W (mm)	Pin1 Quadrant
TPA2000D1PWR	TSSOP	PW	16	2000	330.0	12.4	6.9	5.6	1.6	8.0	12.0	Q1

TAPE AND REEL BOX DIMENSIONS

*All dimensions are nominal

Device	Package Type	Package Drawing	Pins	SPQ	Length (mm)	Width (mm)	Height (mm)
TPA2000D1PWR	TSSOP	PW	16	2000	367.0	367.0	35.0

PW (R-PDSO-G16)

PLASTIC SMALL OUTLINE



4040064-4/G 02/11

- NOTES:
- A. All linear dimensions are in millimeters. Dimensioning and tolerancing per ASME Y14.5M-1994.
 - B. This drawing is subject to change without notice.
 -  Body length does not include mold flash, protrusions, or gate burrs. Mold flash, protrusions, or gate burrs shall not exceed 0,15 each side.
 -  Body width does not include interlead flash. Interlead flash shall not exceed 0,25 each side.
 - E. Falls within JEDEC MO-153

PW (R-PDSO-G16)

PLASTIC SMALL OUTLINE

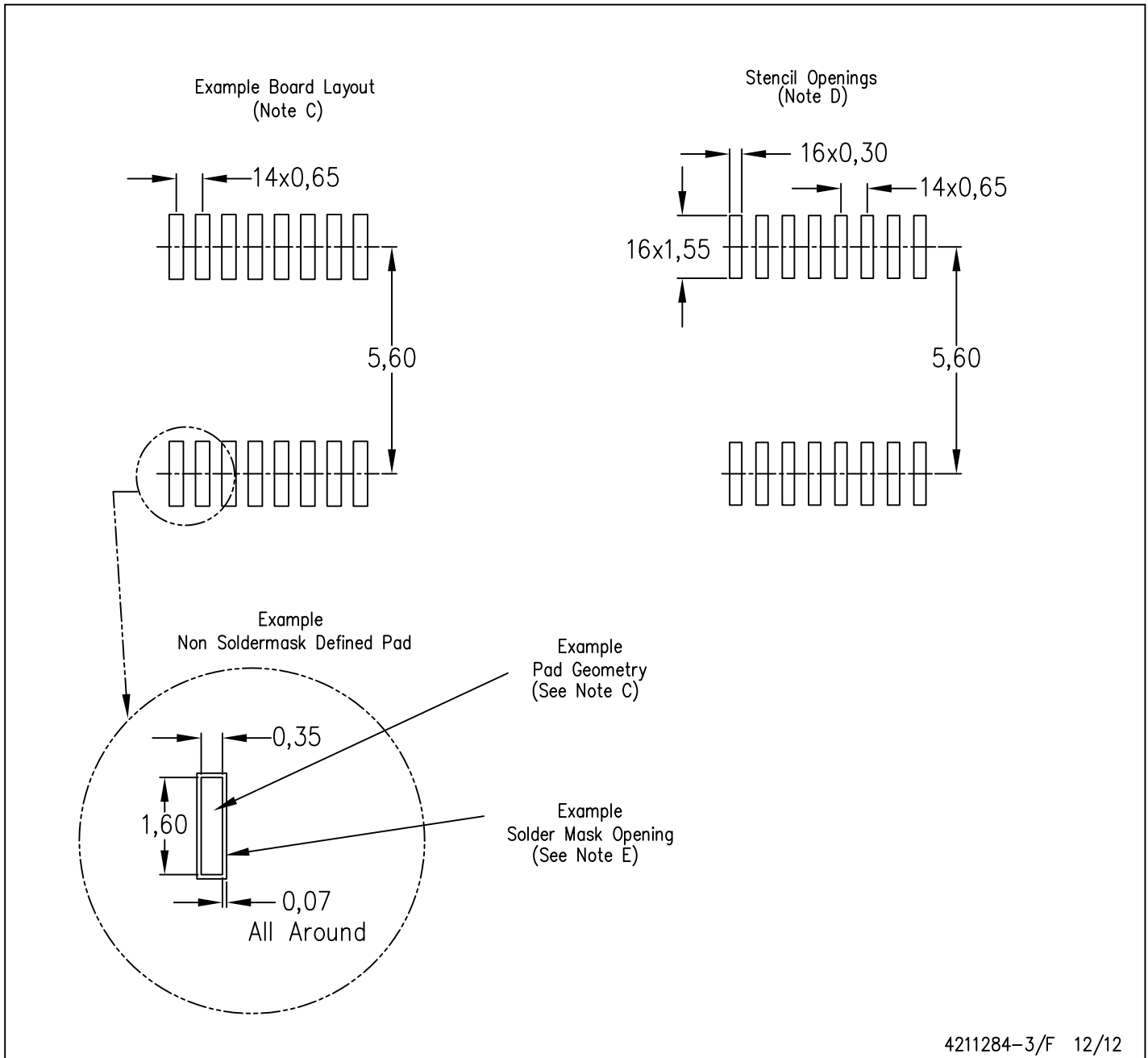

- NOTES:
- All linear dimensions are in millimeters.
 - This drawing is subject to change without notice.
 - Publication IPC-7351 is recommended for alternate designs.
 - Laser cutting apertures with trapezoidal walls and also rounding corners will offer better paste release. Customers should contact their board assembly site for stencil design recommendations. Refer to IPC-7525 for other stencil recommendations.
 - Customers should contact their board fabrication site for solder mask tolerances between and around signal pads.

GQC (S-PBGA-N48)

PLASTIC BALL GRID ARRAY

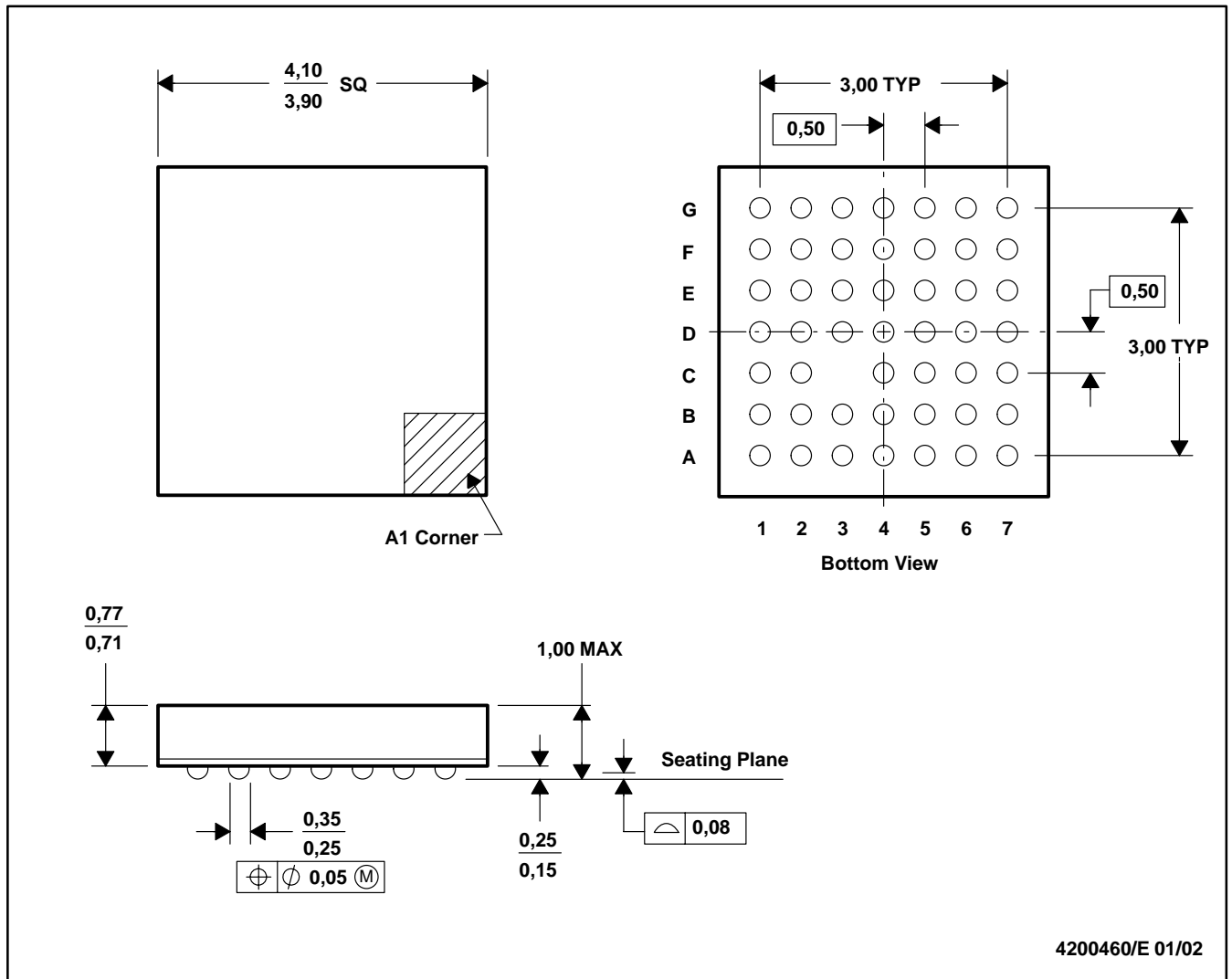

- NOTES: A. All linear dimensions are in millimeters.
 B. This drawing is subject to change without notice.
 C. MicroStar Junior™ BGA configuration
 D. Falls within JEDEC MO-225

MicroStar Junior is a trademark of Texas Instruments.

IMPORTANT NOTICE

Texas Instruments Incorporated and its subsidiaries (TI) reserve the right to make corrections, enhancements, improvements and other changes to its semiconductor products and services per JESD46, latest issue, and to discontinue any product or service per JESD48, latest issue. Buyers should obtain the latest relevant information before placing orders and should verify that such information is current and complete. All semiconductor products (also referred to herein as "components") are sold subject to TI's terms and conditions of sale supplied at the time of order acknowledgment.

TI warrants performance of its components to the specifications applicable at the time of sale, in accordance with the warranty in TI's terms and conditions of sale of semiconductor products. Testing and other quality control techniques are used to the extent TI deems necessary to support this warranty. Except where mandated by applicable law, testing of all parameters of each component is not necessarily performed.

TI assumes no liability for applications assistance or the design of Buyers' products. Buyers are responsible for their products and applications using TI components. To minimize the risks associated with Buyers' products and applications, Buyers should provide adequate design and operating safeguards.

TI does not warrant or represent that any license, either express or implied, is granted under any patent right, copyright, mask work right, or other intellectual property right relating to any combination, machine, or process in which TI components or services are used. Information published by TI regarding third-party products or services does not constitute a license to use such products or services or a warranty or endorsement thereof. Use of such information may require a license from a third party under the patents or other intellectual property of the third party, or a license from TI under the patents or other intellectual property of TI.

Reproduction of significant portions of TI information in TI data books or data sheets is permissible only if reproduction is without alteration and is accompanied by all associated warranties, conditions, limitations, and notices. TI is not responsible or liable for such altered documentation. Information of third parties may be subject to additional restrictions.

Resale of TI components or services with statements different from or beyond the parameters stated by TI for that component or service voids all express and any implied warranties for the associated TI component or service and is an unfair and deceptive business practice. TI is not responsible or liable for any such statements.

Buyer acknowledges and agrees that it is solely responsible for compliance with all legal, regulatory and safety-related requirements concerning its products, and any use of TI components in its applications, notwithstanding any applications-related information or support that may be provided by TI. Buyer represents and agrees that it has all the necessary expertise to create and implement safeguards which anticipate dangerous consequences of failures, monitor failures and their consequences, lessen the likelihood of failures that might cause harm and take appropriate remedial actions. Buyer will fully indemnify TI and its representatives against any damages arising out of the use of any TI components in safety-critical applications.

In some cases, TI components may be promoted specifically to facilitate safety-related applications. With such components, TI's goal is to help enable customers to design and create their own end-product solutions that meet applicable functional safety standards and requirements. Nonetheless, such components are subject to these terms.

No TI components are authorized for use in FDA Class III (or similar life-critical medical equipment) unless authorized officers of the parties have executed a special agreement specifically governing such use.

Only those TI components which TI has specifically designated as military grade or "enhanced plastic" are designed and intended for use in military/aerospace applications or environments. Buyer acknowledges and agrees that any military or aerospace use of TI components which have **not** been so designated is solely at the Buyer's risk, and that Buyer is solely responsible for compliance with all legal and regulatory requirements in connection with such use.

TI has specifically designated certain components as meeting ISO/TS16949 requirements, mainly for automotive use. In any case of use of non-designated products, TI will not be responsible for any failure to meet ISO/TS16949.

Products

Audio	www.ti.com/audio
Amplifiers	amplifier.ti.com
Data Converters	dataconverter.ti.com
DLP® Products	www.dlp.com
DSP	dsp.ti.com
Clocks and Timers	www.ti.com/clocks
Interface	interface.ti.com
Logic	logic.ti.com
Power Mgmt	power.ti.com
Microcontrollers	microcontroller.ti.com
RFID	www.ti-rfid.com
OMAP Applications Processors	www.ti.com/omap
Wireless Connectivity	www.ti.com/wirelessconnectivity

Applications

Automotive and Transportation	www.ti.com/automotive
Communications and Telecom	www.ti.com/communications
Computers and Peripherals	www.ti.com/computers
Consumer Electronics	www.ti.com/consumer-apps
Energy and Lighting	www.ti.com/energy
Industrial	www.ti.com/industrial
Medical	www.ti.com/medical
Security	www.ti.com/security
Space, Avionics and Defense	www.ti.com/space-avionics-defense
Video and Imaging	www.ti.com/video

TI E2E Community

e2e.ti.com