

TPA6101A2

50-mW ULTRALOW-VOLTAGE, FIXED-GAIN STEREO HEADPHONE AUDIO POWER AMPLIFIER

SLOS331C – AUGUST 2000 – REVISED MARCH 2007

- Minimal External Components Required
- 1.6-V to 3.6-V Supply Voltage Range
- 50-mW Stereo Output
- Low Supply Current . . . 0.75 mA
- Low Shutdown Current . . . 50 nA
- Gain Set Internally to 2 dB
- Pop Reduction Circuitry
- Internal Mid-Rail Generation
- Thermal and Short-Circuit Protection
- Surface-Mount Packaging
 - 3-mm × 5-mm MSOP Package (DGN)
 - 5-mm × 6-mm SOIC Package (D)
 - 2,5-mm × 2,5-mm MicroStar Junior™ BGA Package (ZQY)

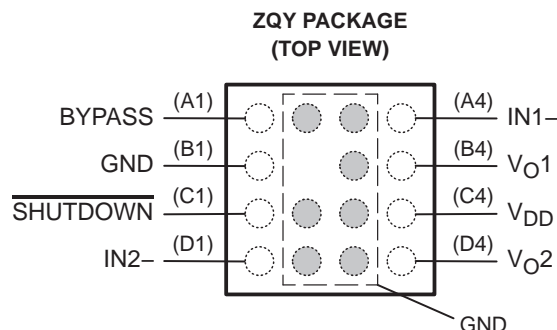
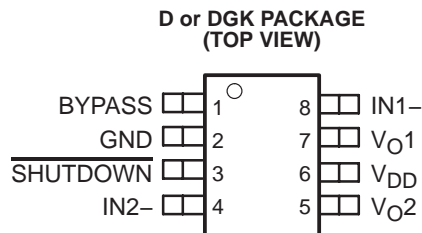

description

The TPA6101A2 is a stereo audio power amplifier packaged in an 8-pin SOIC package, an 8-pin MSOP package, or a 15-ball BGA package, capable of delivering 50 mW of continuous RMS power per channel into 16-Ω loads. Amplifier gain is internally set to 2 dB (inverting) to save board space by eliminating six external resistors.

The TPA6101A2 is optimized for battery applications because of its low supply current, shutdown current, and THD+N. To obtain the low-supply-voltage range, the TPA6101A2 biases BYPASS to $V_{DD}/4$.

When driving a 16-Ω load with 40-mW output power from 3.3 V, THD+N is 0.08% at 1 kHz, and less than 0.2% across the audio band of 20 Hz to 20 kHz. For 30 mW into 32-Ω loads, the THD+N is reduced to less than 0.06% at 1 kHz, and is less than 0.3% across the audio band of 20 Hz to 20 kHz.

typical application circuit

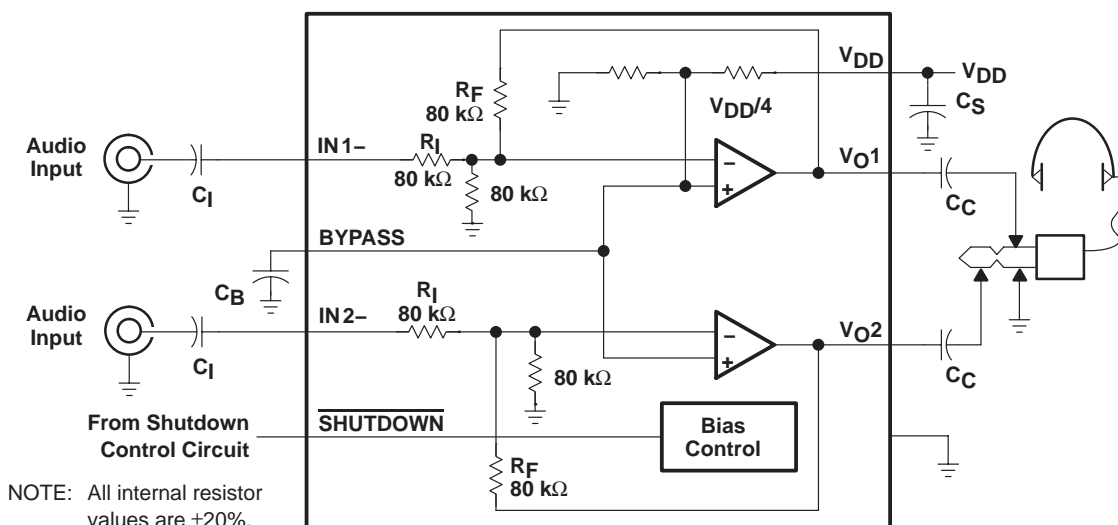

Please be aware that an important notice concerning availability, standard warranty, and use in critical applications of Texas Instruments semiconductor products and disclaimers thereto appears at the end of this data sheet.

MicroStar BGA is a trademark of Texas Instruments.

PRODUCTION DATA information is current as of publication date. Products conform to specifications per the terms of Texas Instruments standard warranty. Production processing does not necessarily include testing of all parameters.



POST OFFICE BOX 655303 • DALLAS, TEXAS 75265

Copyright © 2007, Texas Instruments Incorporated

TPA6101A2
50-mW ULTRALOW-VOLTAGE, FIXED-GAIN STEREO HEADPHONE
AUDIO POWER AMPLIFIER

AVAILABLE OPTIONS

| T _A | PACKAGED DEVICE | | | MSOP SYMBOLIZATION | BGA SYMBOLIZATION |
|----------------|-------------------|--------------|---------------|-----------------------|----------------------|
| | SMALL OUTLINE (D) | MSOP (DGK) | BGA (ZQY) | | |
| -40°C to 85°C | TPA6101A2D | TPA6101A2DGK | TPA6101A2ZQYR | AJM | AAQI |

Terminal Functions

| TERMINAL | | | I/O | DESCRIPTION |
|-----------------|-----------|-----|-----|--|
| NAME | NO. | | | |
| | D, DGK | ZQY | | |
| BYPASS | 1 | A1 | I | Tap to voltage divider for internal mid-supply bias supply. BYPASS is set at V _{DD} /4. Connect to a 0.1-μF to 1-μF low-ESR capacitor for best performance. |
| GND | 2 | B1 | – | GND is the ground connection. |
| IN1– | 8 | A4 | I | IN1– is the inverting input for channel 1. |
| IN2– | 4 | D1 | I | IN2– is the inverting input for channel 2. |
| SHUTDOWN | 3 | C1 | I | Active-low input. When held low, the device is placed in a low-supply-current mode. |
| V _{DD} | 6 | C4 | – | V _{DD} is the supply voltage terminal. |
| V _{O1} | 7 | B4 | O | V _{O1} is the audio output for channel 1. |
| V _{O2} | 5 | D4 | O | V _{O2} is the audio output for channel 2. |

absolute maximum ratings over operating free-air temperature (unless otherwise noted)†

| | |
|--|-----------------------------------|
| Supply voltage, V _{DD} | 4 V |
| Input voltage, V _I | –0.3 V to V _{DD} + 0.3 V |
| Continuous total power dissipation | Internally Limited |
| Operating junction temperature range, T _J | –40°C to 150°C |
| Storage temperature range, T _{stg} | –65°C to 150°C |
| Lead temperature 1,6 mm (1/16 inch) from case for 10 seconds | 260°C |

† Stresses beyond those listed under “absolute maximum ratings” may cause permanent damage to the device. These are stress ratings only, and functional operation of the device at these or any other conditions beyond those indicated under “recommended operating conditions” is not implied. Exposure to absolute-maximum-rated conditions for extended periods may affect device reliability.

DISSIPATION RATING TABLE

| PACKAGE | T _A ≤ 25°C POWER RATING | DERATING FACTOR ABOVE T _A = 25°C | T _A = 70°C POWER RATING | T _A = 85°C POWER RATING |
|---------|---------------------------------------|--|---------------------------------------|---------------------------------------|
| D | 710 mW | 5.68 mW/°C | 454 mW | 369 mW |
| DGK | 469 mW | 3.75 mW/°C | 300 mW | 244 mW |
| ZQY | 2 W | 17.1 mW/°C | 1.28 W | 1.04 W |

recommended operating conditions

| | MIN | MAX | UNIT |
|--|---------------------|----------------------|------|
| Supply voltage, V _{DD} | 1.6 | 3.6 | V |
| High-level input voltage, V _{IH} (SHUTDOWN) | 0.6 V _{DD} | | V |
| Low-level input voltage, V _{IL} (SHUTDOWN) | | 0.25 V _{DD} | V |
| Operating free-air temperature, T _A | –40 | 85 | °C |



TPA6101A2
50-mW ULTRALOW-VOLTAGE, FIXED-GAIN STEREO HEADPHONE
AUDIO POWER AMPLIFIER

dc electrical characteristics at $T_A = 25^\circ\text{C}$, $V_{DD} = 3.6\text{ V}$ (unless otherwise noted)

| PARAMETER | | TEST CONDITIONS | MIN | TYP | MAX | UNIT |
|---------------------|---|--|-----|------|-----|------------------|
| V_{OO} | Output offset voltage | $A_V = 2\text{ dB}$ | | 5 | 40 | mV |
| PSRR | Power supply rejection ratio | $V_{DD} = 3\text{ V to } 3.6\text{ V}$ | | 72 | | dB |
| I_{DD} | Supply current | $\overline{\text{SHUTDOWN}} = 3.6\text{ V}$ | | 0.75 | 1.5 | mA |
| $I_{DD}(\text{SD})$ | Supply current in $\overline{\text{SHUTDOWN}}$ mode | $\overline{\text{SHUTDOWN}} = 0\text{ V}$ | | 50 | 250 | nA |
| $ I_{IH} $ | High-level input current ($\overline{\text{SHUTDOWN}}$) | $V_{DD} = 3.6\text{ V}$, $V_I = V_{DD}$ | | | 1 | μA |
| $ I_{IL} $ | Low-level input current ($\overline{\text{SHUTDOWN}}$) | $V_{DD} = 3.6\text{ V}$, $V_I = 0\text{ V}$ | | | 1 | μA |
| Z_I | Input impedance | | | 80 | | $\text{k}\Omega$ |

ac operating characteristics, $V_{DD} = 3.3\text{ V}$, $T_A = 25^\circ\text{C}$, $R_L = 16\ \Omega$

| PARAMETER | | TEST CONDITIONS | MIN | TYP | MAX | UNIT |
|-----------|--|---|-----|------|-----|---------------------------|
| G | Gain | | | 2 | | dB |
| P_O | Output power (each channel) | $\text{THD} \leq 0.1\%$, $f = 1\text{ kHz}$ | | 50 | | mW |
| THD+N | Total harmonic distortion + noise | $P_O = 45\text{ mW}$, $20\text{ Hz} - 20\text{ kHz}$ | | 0.4% | | |
| B_{OM} | Maximum output power BW | $\text{THD} < 0.5\%$ | | > 20 | | kHz |
| k_{SVR} | Supply ripple rejection ratio | $f = 1\text{ kHz}$ | | 47 | | dB |
| SNR | Signal-to-noise ratio | $P_O = 50\text{ mW}$ | | 86 | | dB |
| V_n | Noise output voltage (no-noise weighting filter) | | | 45 | | $\mu\text{V}(\text{rms})$ |

ac operating characteristics, $V_{DD} = 3.3\text{ V}$, $T_A = 25^\circ\text{C}$, $R_L = 32\ \Omega$

| PARAMETER | | TEST CONDITIONS | MIN | TYP | MAX | UNIT |
|-----------|--|---|-----|------|-----|---------------------------|
| G | Gain | | | 2 | | dB |
| P_O | Output power (each channel) | $\text{THD} \leq 0.1\%$, $f = 1\text{ kHz}$ | | 35 | | mW |
| THD+N | Total harmonic distortion + noise | $P_O = 30\text{ mW}$, $20\text{ Hz} - 20\text{ kHz}$ | | 0.4% | | |
| B_{OM} | Maximum output power BW | $\text{THD} < 0.4\%$ | | > 20 | | kHz |
| k_{SVR} | Supply ripple rejection ratio | $f = 1\text{ kHz}$ | | 47 | | dB |
| SNR | Signal-to-noise ratio | $P_O = 30\text{ mW}$ | | 86 | | dB |
| V_n | Noise output voltage (no-noise weighting filter) | | | 50 | | $\mu\text{V}(\text{rms})$ |

TPA6101A2
50-mW ULTRALOW-VOLTAGE, FIXED-GAIN STEREO HEADPHONE
AUDIO POWER AMPLIFIER

dc electrical characteristics at $T_A = 25^\circ\text{C}$, $V_{DD} = 1.6\text{ V}$ (unless otherwise noted)

| PARAMETER | | TEST CONDITIONS | MIN | TYP | MAX | UNIT |
|---------------------|-------------------------------------|---|-----|------|-----|---------------|
| V_{OO} | Output offset voltage | $A_V = 2\text{ dB}$ | | 5 | 40 | mV |
| PSRR | Power supply rejection ratio | $V_{DD} = 1.4\text{ V to } 1.8\text{ V}$ | | 80 | | dB |
| I_{DD} | Supply current | $\overline{\text{SHUTDOWN}} = 1.6\text{ V}$ | | 0.65 | 1.2 | mA |
| $I_{DD}(\text{SD})$ | Supply current in SHUTDOWN mode | $\overline{\text{SHUTDOWN}} = 0\text{ V}$ | | 50 | 250 | nA |
| $ I_{IH} $ | High-level input current (SHUTDOWN) | $V_{DD} = 1.6\text{ V}, V_I = V_{DD}$ | | | 1 | μA |
| $ I_{IL} $ | Low-level input current (SHUTDOWN) | $V_{DD} = 1.6\text{ V}, V_I = 0\text{ V}$ | | | 1 | μA |
| Z_I | Input impedance | | | 80 | | k Ω |

ac operating characteristics, $V_{DD} = 1.6\text{ V}$, $T_A = 25^\circ\text{C}$, $R_L = 16\ \Omega$

| PARAMETER | | TEST CONDITIONS | MIN | TYP | MAX | UNIT |
|-----------|--|--|-----|--------|-----|---------------------------|
| G | Gain | | | 2 | | dB |
| P_O | Output power (each channel) | THD $\leq 0.5\%$, $f = 1\text{ kHz}$ | | 10 | | mW |
| THD+N | Total harmonic distortion + noise | $P_O = 9.5\text{ mW}$, $20\text{ Hz} - 20\text{ kHz}$ | | 0.06% | | |
| B_{OM} | Maximum output power BW | THD $< 1\%$ | | > 20 | | kHz |
| k_{SVR} | Supply ripple rejection ratio | $f = 1\text{ kHz}$ | | 47 | | dB |
| SNR | Signal-to-noise ratio | $P_O = 10\text{ mW}$ | | 82 | | dB |
| V_n | Noise output voltage (no-noise weighting filter) | | | 32 | | $\mu\text{V}(\text{rms})$ |

ac operating characteristics, $V_{DD} = 1.6\text{ V}$, $T_A = 25^\circ\text{C}$, $R_L = 32\ \Omega$

| PARAMETER | | TEST CONDITIONS | MIN | TYP | MAX | UNIT |
|-----------|--|--|-----|--------|-----|---------------------------|
| G | Gain | | | 2 | | dB |
| P_O | Output power (each channel) | THD $\leq 0.5\%$, $f = 1\text{ kHz}$ | | 7.5 | | mW |
| THD+N | Total harmonic distortion + noise | $P_O = 6.5\text{ mW}$, $20\text{ Hz} - 20\text{ kHz}$ | | 0.05% | | |
| B_{OM} | Maximum output power BW | THD $< 1\%$ | | > 20 | | kHz |
| k_{SVR} | Supply ripple rejection ratio | $f = 1\text{ kHz}$ | | 47 | | dB |
| SNR | Signal-to-noise ratio | $P_O = 7.5\text{ mW}$ | | 84 | | dB |
| V_n | Noise output voltage (no-noise weighting filter) | | | 32 | | $\mu\text{V}(\text{rms})$ |

TYPICAL CHARACTERISTICS

Table of Graphs

| | | FIGURE |
|-----------|--------------------------------------|--------------------|
| THD+N | Total harmonic distortion plus noise | vs Frequency |
| | | vs Output power |
| | | vs Output voltage |
| P_O | Output power | vs Load resistance |
| k_{SVR} | Supply ripple rejection ratio | vs Frequency |
| V_n | Output noise voltage | vs Frequency |
| | Crosstalk | vs Frequency |
| | Closed-loop gain and phase | vs Frequency |
| I_{DD} | Supply current | vs Supply voltage |
| P_D | Power dissipation | vs Output power |



TYPICAL CHARACTERISTICS

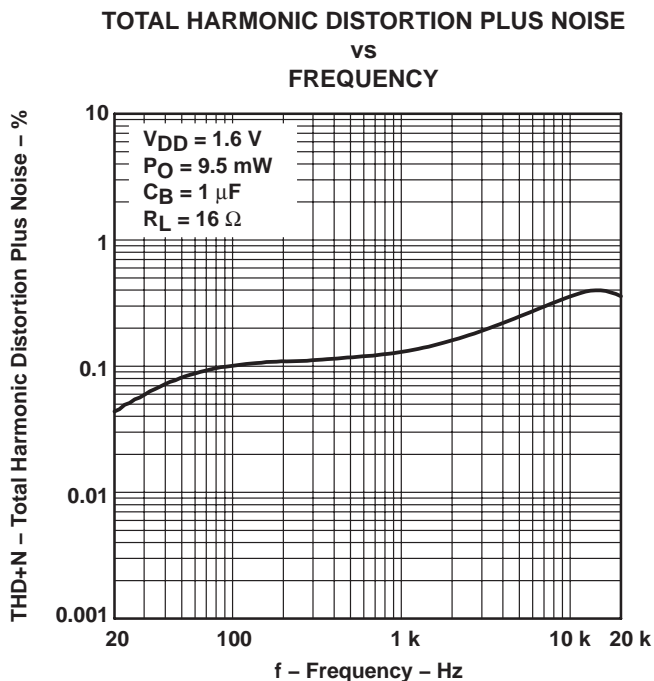

Figure 1

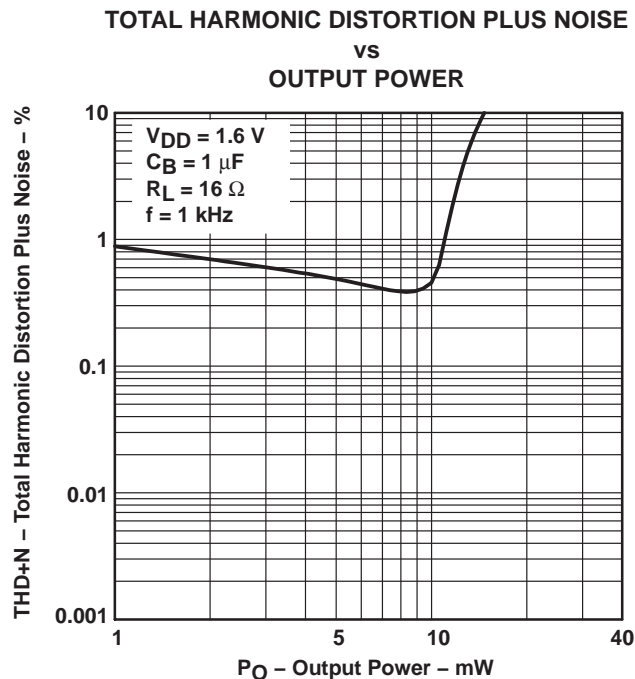

Figure 2

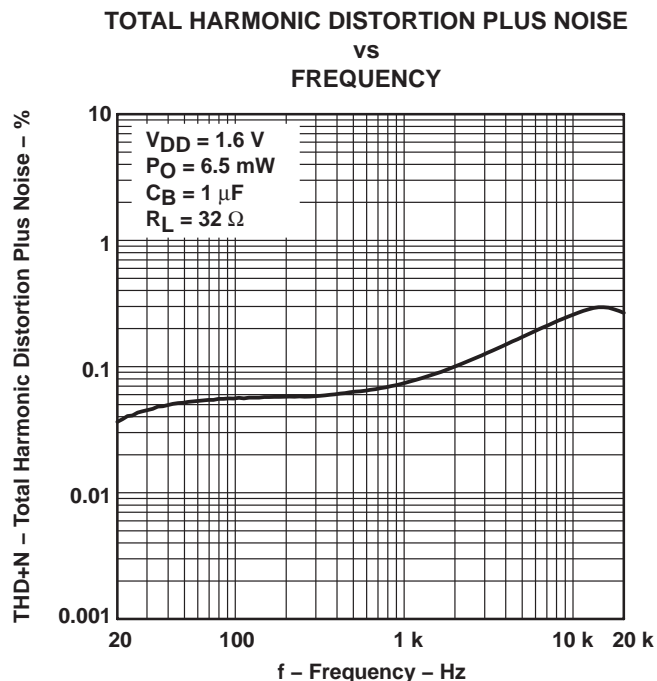

Figure 3

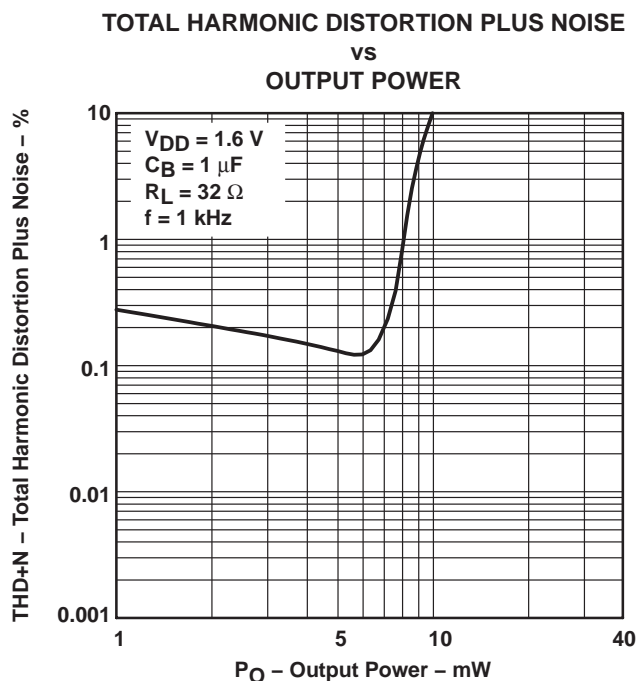

Figure 4

TPA6101A2
50-mW ULTRALOW-VOLTAGE, FIXED-GAIN STEREO HEADPHONE
AUDIO POWER AMPLIFIER

TYPICAL CHARACTERISTICS

TOTAL HARMONIC DISTORTION PLUS NOISE
vs
FREQUENCY

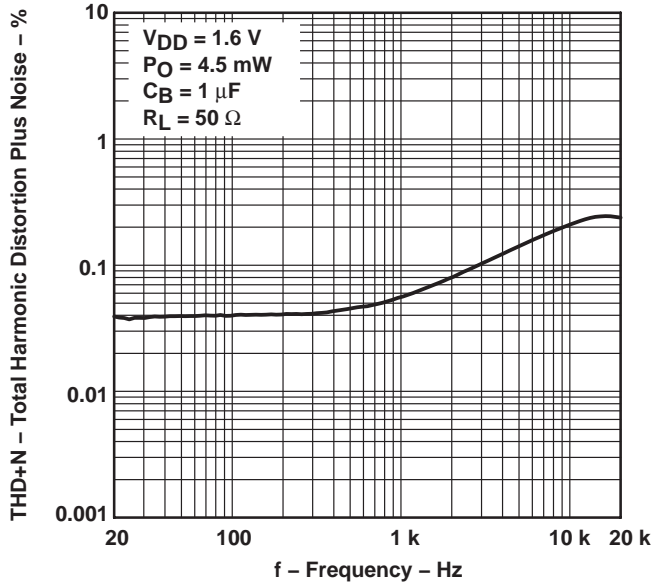

Figure 5

TOTAL HARMONIC DISTORTION PLUS NOISE
vs
OUTPUT POWER

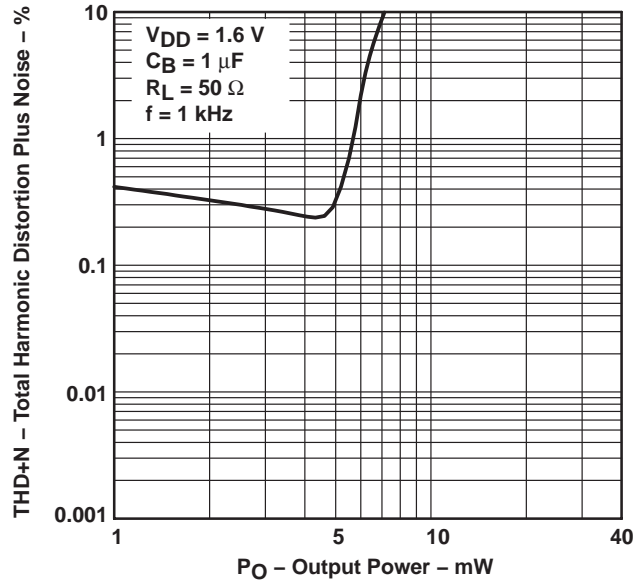

Figure 6

TOTAL HARMONIC DISTORTION PLUS NOISE
vs
FREQUENCY

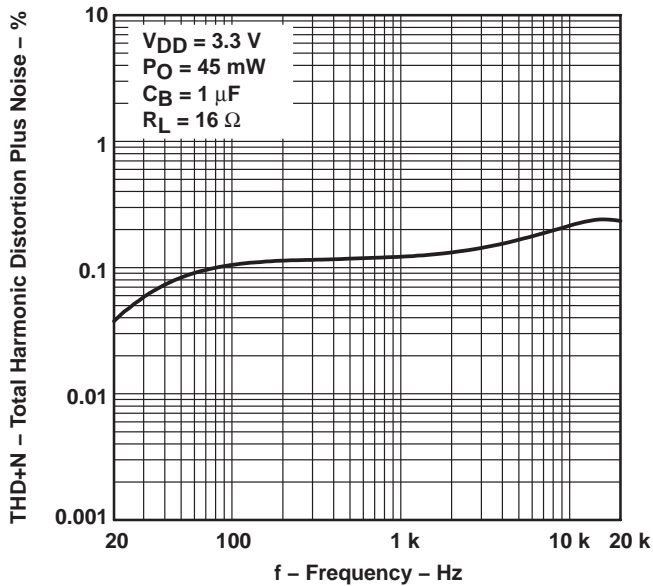

Figure 7

TOTAL HARMONIC DISTORTION PLUS NOISE
vs
OUTPUT POWER

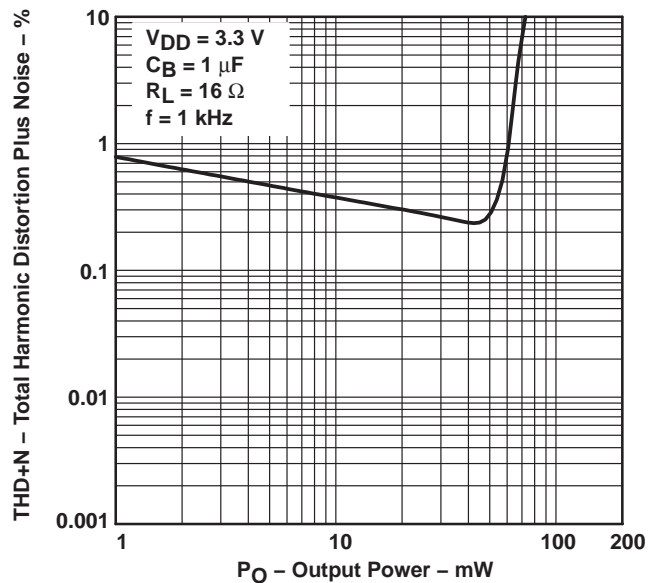

Figure 8

TYPICAL CHARACTERISTICS

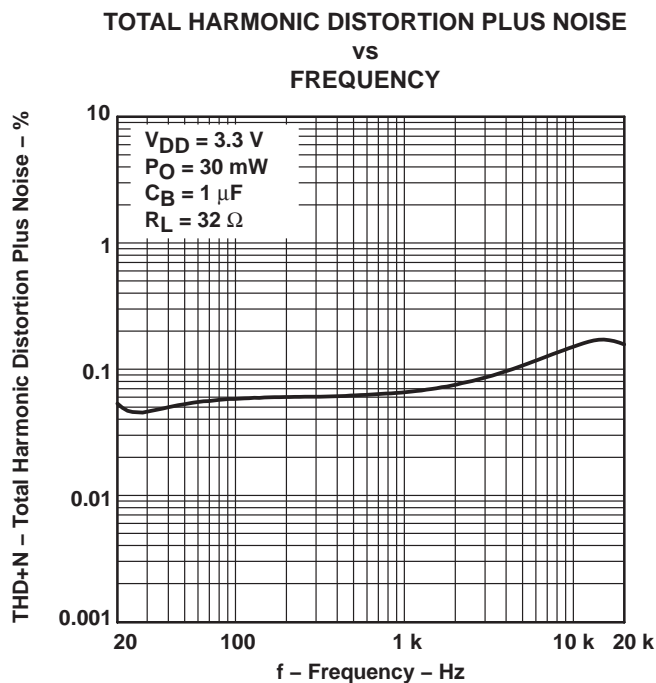

Figure 9

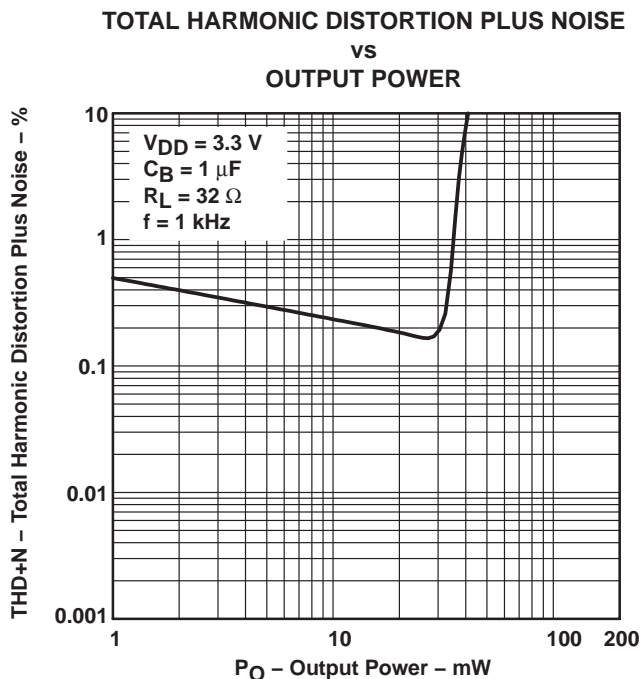

Figure 10

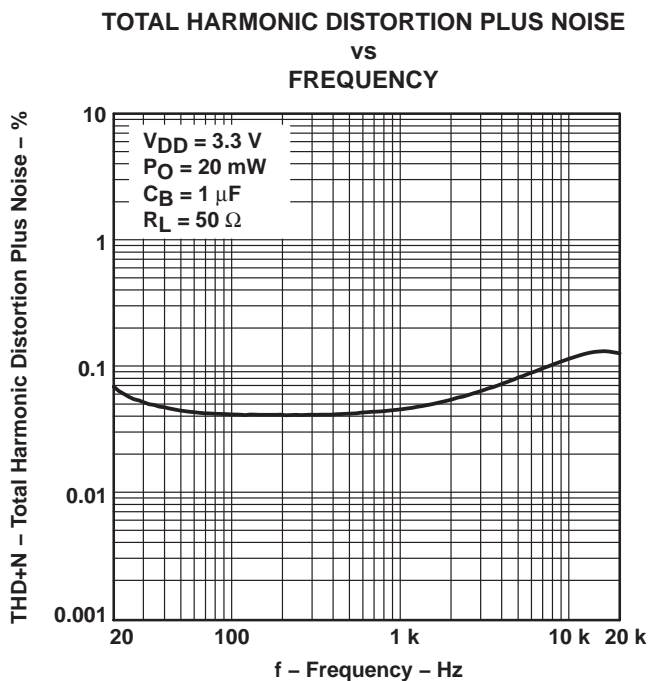

Figure 11

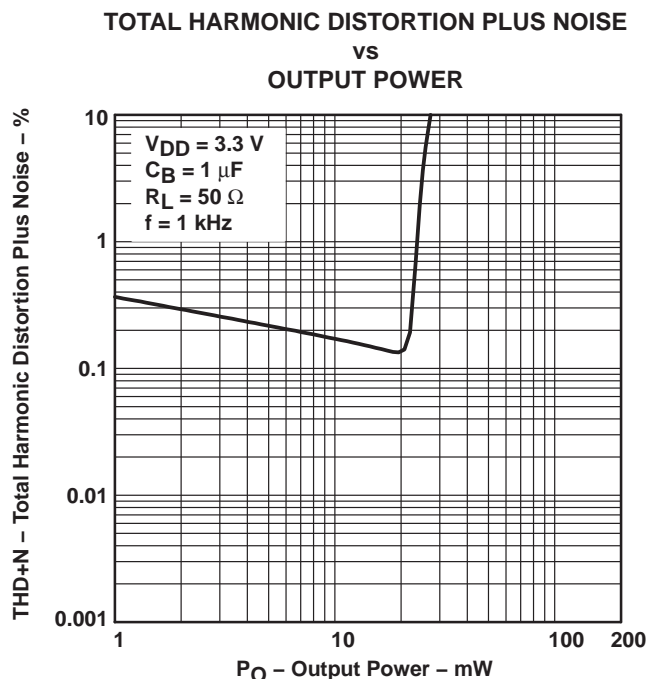

Figure 12

TPA6101A2
50-mW ULTRALOW-VOLTAGE, FIXED-GAIN STEREO HEADPHONE
AUDIO POWER AMPLIFIER

TYPICAL CHARACTERISTICS

TOTAL HARMONIC DISTORTION PLUS NOISE
vs
OUTPUT VOLTAGE

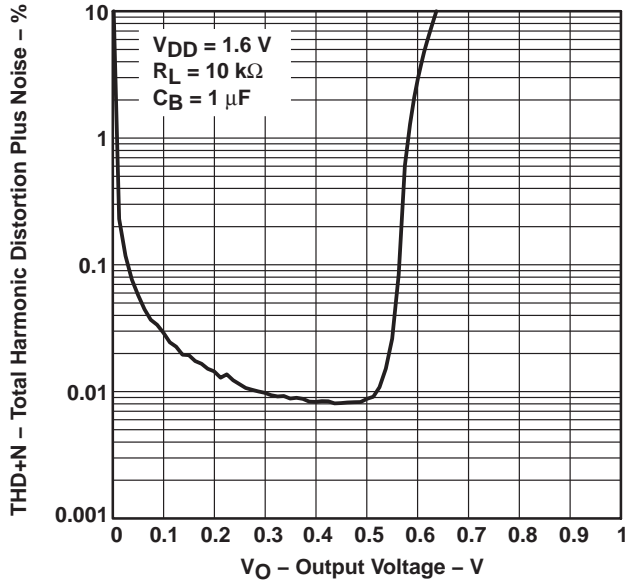

Figure 13

TOTAL HARMONIC DISTORTION PLUS NOISE
vs
OUTPUT VOLTAGE

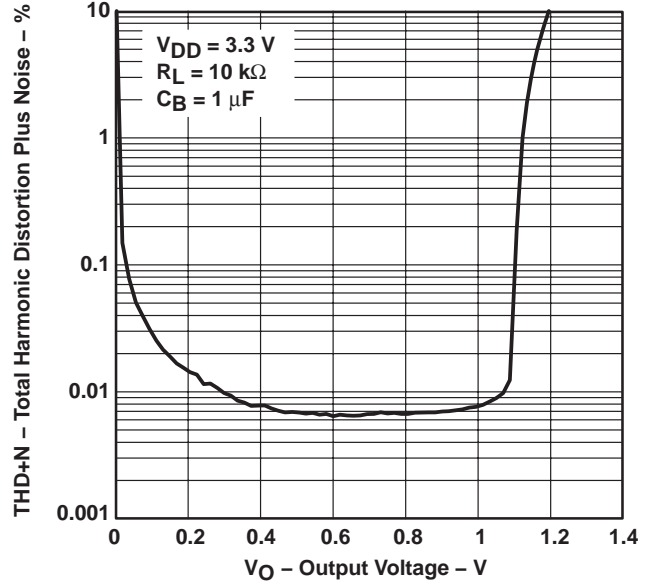

Figure 14

OUTPUT POWER
vs
LOAD RESISTANCE

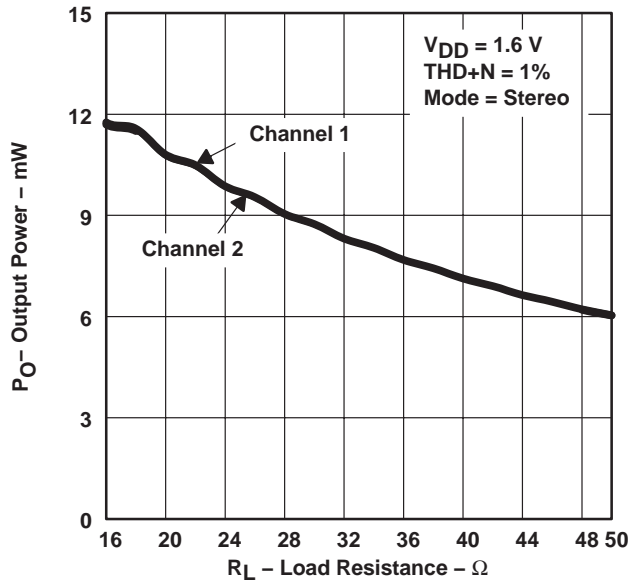

Figure 15

OUTPUT POWER
vs
LOAD RESISTANCE

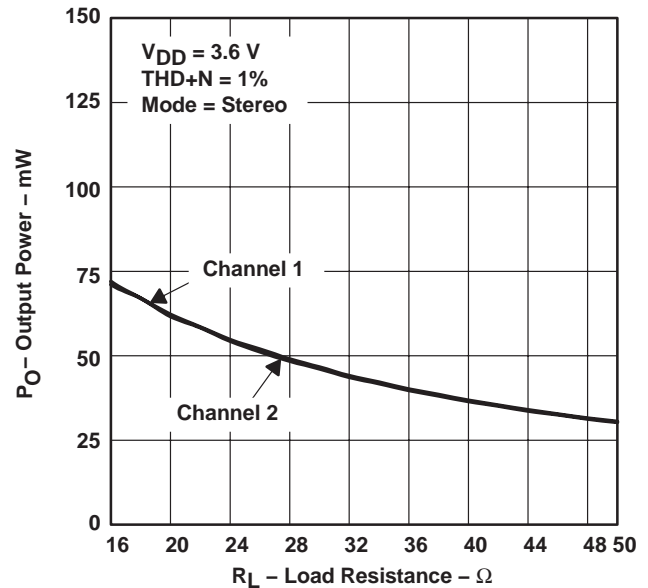

Figure 16

TYPICAL CHARACTERISTICS

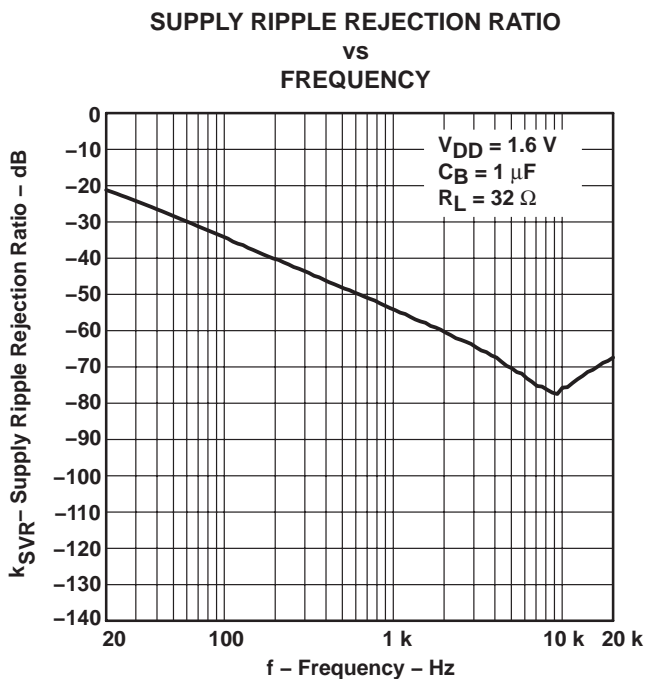

Figure 17

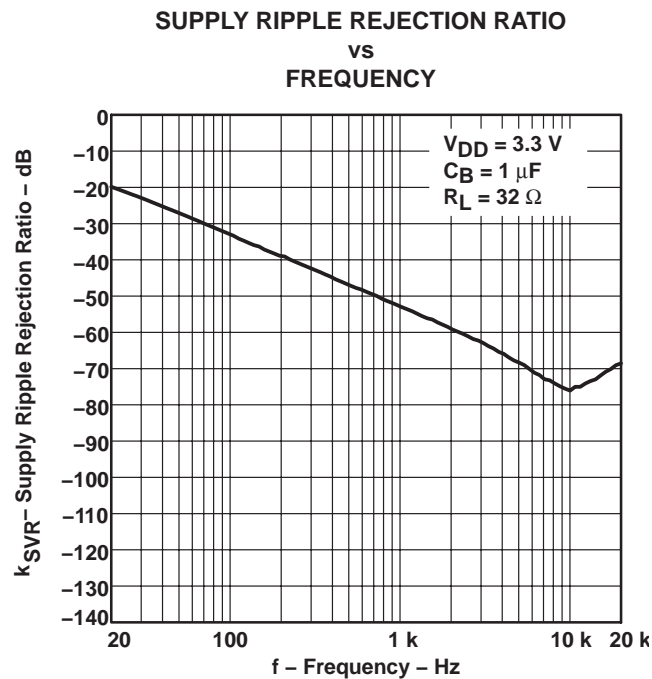

Figure 18

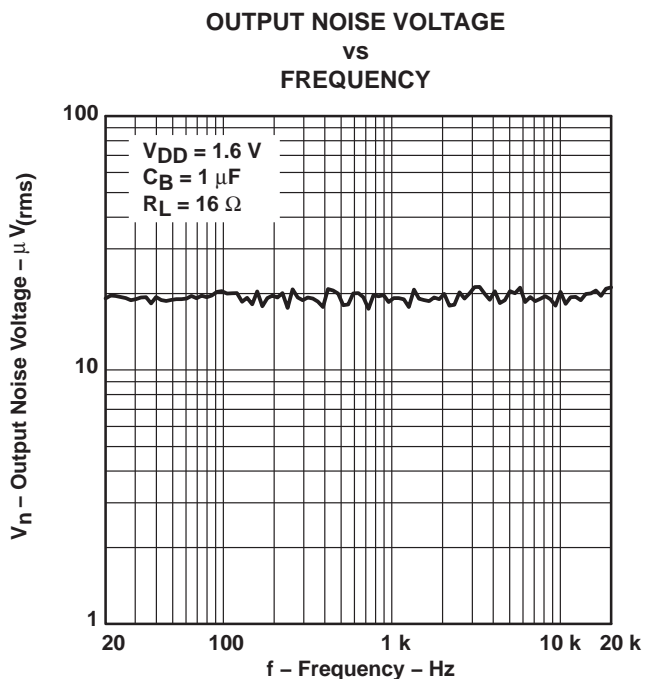

Figure 19

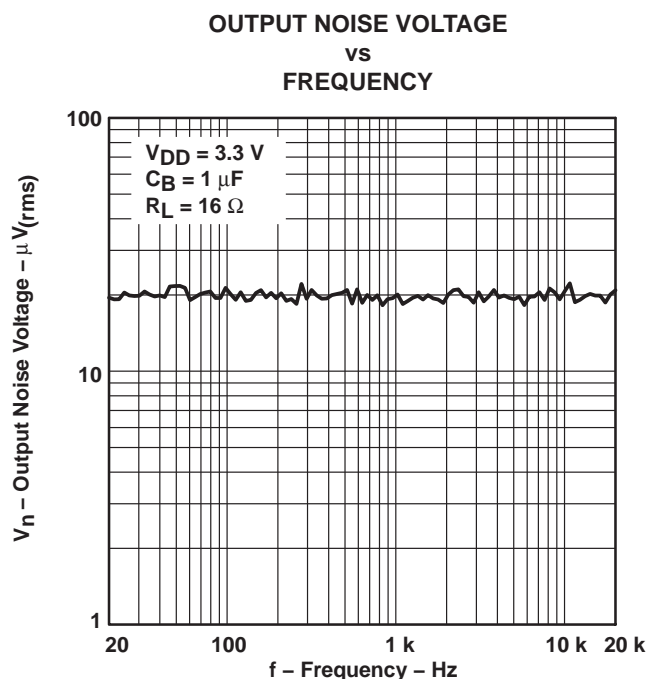

Figure 20

TPA6101A2
50-mW ULTRALOW-VOLTAGE, FIXED-GAIN STEREO HEADPHONE
AUDIO POWER AMPLIFIER

TYPICAL CHARACTERISTICS

CROSSTALK
VS
FREQUENCY

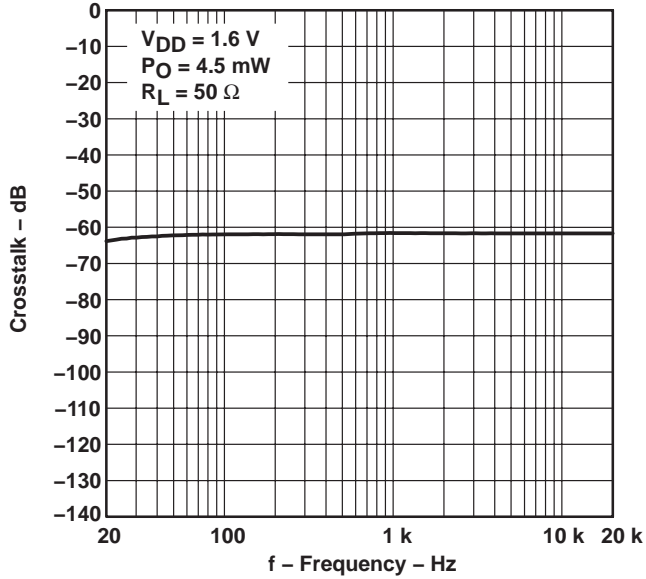

Figure 21

CROSSTALK
VS
FREQUENCY

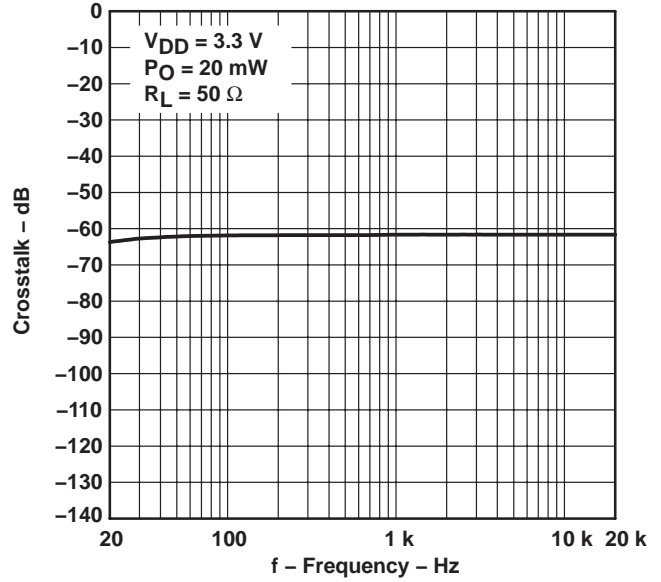

Figure 22

CLOSED-LOOP GAIN AND PHASE
VS
FREQUENCY

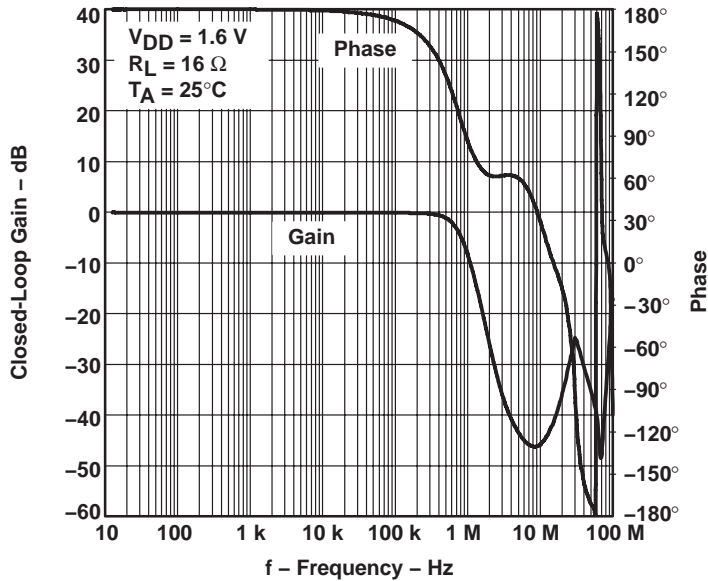

Figure 23

TYPICAL CHARACTERISTICS

**CLOSED-LOOP GAIN AND PHASE
 vs
 FREQUENCY**

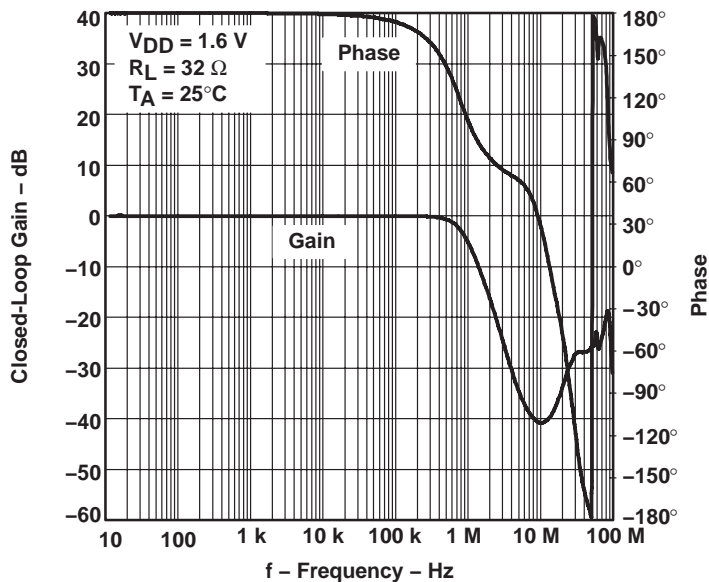

Figure 24

**CLOSED-LOOP GAIN AND PHASE
 vs
 FREQUENCY**

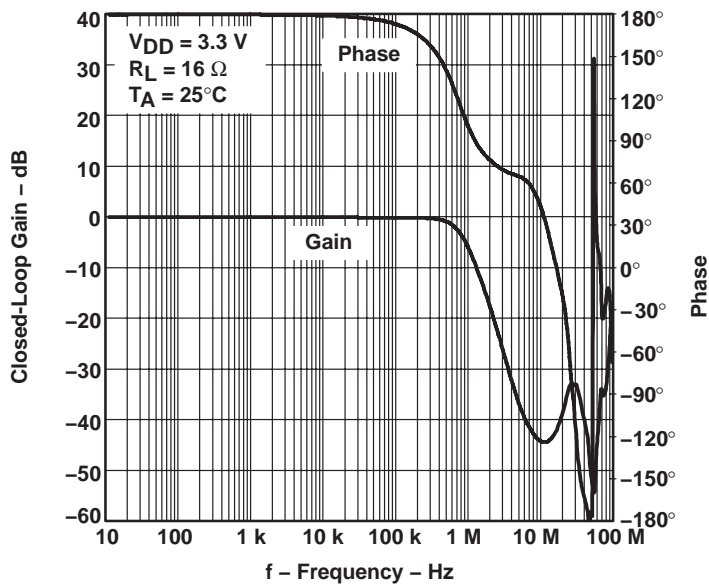

Figure 25

TYPICAL CHARACTERISTICS

CLOSED-LOOP GAIN AND PHASE
vs
FREQUENCY

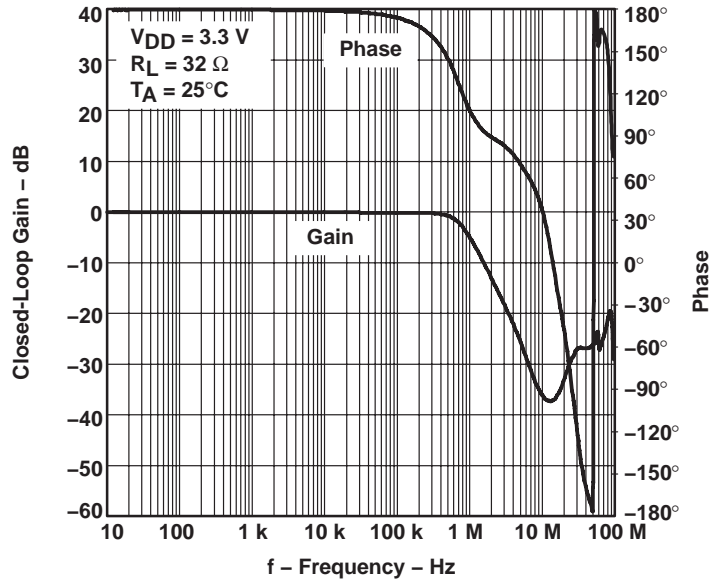

Figure 26

SUPPLY CURRENT
vs
SUPPLY VOLTAGE

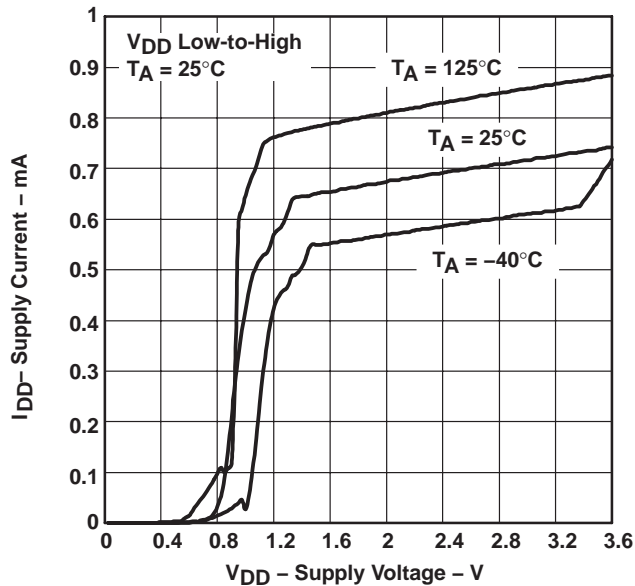

Figure 27

POWER DISSIPATION
vs
OUTPUT POWER

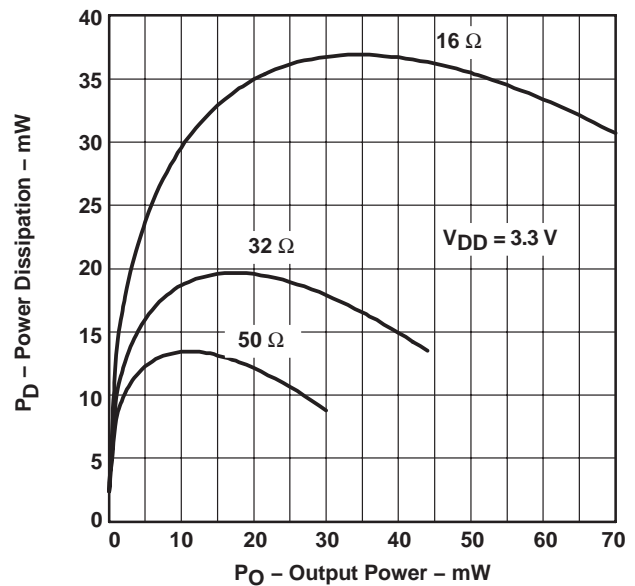

Figure 28

APPLICATION INFORMATION

input capacitor, C_I

In the typical application, an input capacitor (C_I) is required to allow the amplifier to bias the input signal to the proper dc level for optimum operation. In this case, C_I and R_I form a high-pass filter with the corner frequency determined in equation 1. R_I is set internally and is fixed at 80 k Ω .

$$f_c = \frac{1}{2\pi R_I C_I} \quad (1)$$

The value of C_I is important to consider, as it directly affects the bass (low-frequency) performance of the circuit. Consider the example where the specification calls for a flat bass response down to 20 Hz. Equation 1 is reconfigured as equation 2.

$$C_I = \frac{1}{2\pi R_I f_c} \quad (2)$$

In this example, C_I is approximately 0.1 μ F. A further consideration for this capacitor is the leakage path from the input source through the input network (R_I , C_I) and the feedback resistor (R_F) to the load. This leakage current creates a dc-offset voltage at the input to the amplifier that reduces useful headroom. For this reason, a low-leakage tantalum or ceramic capacitor is the best choice. When polarized capacitors are used, the positive side of the capacitor should face the amplifier input in most applications, as the dc level there is held at $V_{DD}/4$, which is likely higher than the source dc level. It is important to confirm the capacitor polarity in the application.

power supply decoupling, C_S

The TPA6101A2 is a high-performance CMOS audio amplifier that requires adequate power supply decoupling to ensure that the output total harmonic distortion (THD) is as low as possible. Power supply decoupling also prevents oscillations for long lead lengths between the amplifier and the speaker. The optimum decoupling is achieved by using two capacitors of different types that target different types of noise on the power supply leads. For higher frequency transients, spikes, or digital hash on the line, a good low equivalent-series-resistance (ESR) ceramic capacitor, typically 0.1 μ F, placed as close as possible to the device V_{DD} lead, works best. For filtering lower-frequency noise signals, a larger, aluminum electrolytic capacitor of 10 μ F or greater placed near the power amplifier is recommended.

midrail bypass capacitor, C_B

The midrail bypass capacitor (C_B) serves several important functions. During start-up, C_B determines the rate at which the amplifier starts up. This helps to push the start-up pop noise into the subaudible range (so low it can not be heard). The second function is to reduce noise produced by the power supply caused by coupling into the output drive signal. This noise is from the midrail generation circuit internal to the amplifier. The capacitor is fed from a 55-k Ω source inside the amplifier. To keep the start-up pop as low as possible, the relationship shown in Equation 3 should be maintained.

$$\frac{1}{(C_B \times 55 \text{ k}\Omega)} \leq \frac{1}{(C_I R_I)} \quad (3)$$

As an example, consider a circuit where C_B is 1 μ F, C_I is 0.1 μ F, and R_I is 80 k Ω . Inserting these values into Equation 3 results in: $18.18 \leq 125$ which satisfies the rule. Bypass capacitor (C_B) values of 0.47 μ F to 1 μ F and ceramic or tantalum low-ESR capacitors are recommended for the best THD and noise performance.

APPLICATION INFORMATION

output coupling capacitor, C_C

In the typical single-supply, single-ended (SE) configuration, an output coupling capacitor (C_C) is required to block the dc bias at the output of the amplifier, thus preventing dc currents in the load. As with the input coupling capacitor, the output coupling capacitor and impedance of the load from a high-pass filter is governed by Equation 4.

$$f_c = \frac{1}{2\pi R_L C_C} \tag{4}$$

The main disadvantage, from a performance standpoint, is that the typically small load impedances drive the low-frequency corner higher. Large values of C_C are required to pass low-frequencies into the load. Consider the example where a C_C of 68 μF is chosen and loads vary from 32 Ω to 47 k Ω . Table 1 summarizes the frequency response characteristics of each configuration.

Table 1. Common Load Impedances vs Low-Frequency Output Characteristics in SE Mode

| R_L | C_C | LOWEST FREQUENCY |
|-----------------|------------------|------------------|
| 32 Ω | 68 μF | 73 Hz |
| 10,000 Ω | 68 μF | 0.23 Hz |
| 47,000 Ω | 68 μF | 0.05 Hz |

As Table 1 indicates, headphone response is adequate and drive into line-level inputs (a home stereo for example) is very good.

The output coupling capacitor required in single-supply SE mode also places additional constraints on the selection of other components in the amplifier circuit. With the rules described earlier still valid, add the following relationship:

$$\frac{1}{(C_B \times 55 \text{ k}\Omega)} \leq \frac{1}{(C_I R_I)} \ll \frac{1}{R_L C_C} \tag{5}$$

using low-ESR capacitors

Low-ESR capacitors are recommended throughout this application. A real capacitor can be modeled simply as a resistor in series with an ideal capacitor. The voltage drop across this resistor minimizes the beneficial effects of the capacitor in the circuit. The lower the equivalent value of this resistance, the more the real capacitor behaves like an ideal capacitor.

3.3-V versus 1.6-V operation

The TPA6101A2 was designed for operation over a supply range of 1.6 V to 3.6 V. There are no special considerations for 1.6-V versus 3.3-V operation as far as supply bypassing, gain setting, or stability. Supply current is slightly reduced from 0.75 mA (typical) to 0.65 mA (typical). The most important consideration is that of output power. Each amplifier can produce a maximum output voltage swing within a few hundred millivolts of the rails with a 10-k Ω load. However, this voltage swing decreases as the load resistance decreases, and the $r_{DS(on)}$ of the output stage transistors becomes more significant. For example, for a 32- Ω load, the maximum peak output voltage with $V_{DD} = 1.6 \text{ V}$ is approximately 0.7 V with no clipping distortion. This reduced voltage swing effectively reduces the maximum undistorted output power.

PACKAGING INFORMATION

| Orderable Device | Status ⁽¹⁾ | Package Type | Package Drawing | Pins | Package Qty | Eco Plan ⁽²⁾ | Lead/ Ball Finish | MSL Peak Temp ⁽³⁾ | Samples (Requires Login) |
|------------------|-----------------------|----------------------------|-----------------|------|-------------|----------------------------|----------------------|------------------------------|-----------------------------|
| TPA6101A2D | ACTIVE | SOIC | D | 8 | 75 | Green (RoHS & no Sb/Br) | CU NIPDAU | Level-1-260C-UNLIM | |
| TPA6101A2DG4 | ACTIVE | SOIC | D | 8 | 75 | Green (RoHS & no Sb/Br) | CU NIPDAU | Level-1-260C-UNLIM | |
| TPA6101A2DGKR | ACTIVE | VSSOP | DGK | 8 | 2500 | Green (RoHS & no Sb/Br) | CU NIPDAU | Level-1-260C-UNLIM | |
| TPA6101A2DGKRG4 | ACTIVE | VSSOP | DGK | 8 | 2500 | Green (RoHS & no Sb/Br) | CU NIPDAU | Level-1-260C-UNLIM | |
| TPA6101A2ZQYR | ACTIVE | BGA MICROSTAR JUNIOR | ZQY | 15 | 2500 | Green (RoHS & no Sb/Br) | SNAGCU | Level-2-260C-1 YEAR | |
| TPA6101A2ZQYRG1 | ACTIVE | BGA MICROSTAR JUNIOR | ZQY | 15 | 2500 | Green (RoHS & no Sb/Br) | SNAGCU | Level-2-260C-1 YEAR | |

⁽¹⁾ The marketing status values are defined as follows:

ACTIVE: Product device recommended for new designs.

LIFEBUY: TI has announced that the device will be discontinued, and a lifetime-buy period is in effect.

NRND: Not recommended for new designs. Device is in production to support existing customers, but TI does not recommend using this part in a new design.

PREVIEW: Device has been announced but is not in production. Samples may or may not be available.

OBSOLETE: TI has discontinued the production of the device.

⁽²⁾ Eco Plan - The planned eco-friendly classification: Pb-Free (RoHS), Pb-Free (RoHS Exempt), or Green (RoHS & no Sb/Br) - please check <http://www.ti.com/productcontent> for the latest availability information and additional product content details.

TBD: The Pb-Free/Green conversion plan has not been defined.

Pb-Free (RoHS): TI's terms "Lead-Free" or "Pb-Free" mean semiconductor products that are compatible with the current RoHS requirements for all 6 substances, including the requirement that lead not exceed 0.1% by weight in homogeneous materials. Where designed to be soldered at high temperatures, TI Pb-Free products are suitable for use in specified lead-free processes.

Pb-Free (RoHS Exempt): This component has a RoHS exemption for either 1) lead-based flip-chip solder bumps used between the die and package, or 2) lead-based die adhesive used between the die and leadframe. The component is otherwise considered Pb-Free (RoHS compatible) as defined above.

Green (RoHS & no Sb/Br): TI defines "Green" to mean Pb-Free (RoHS compatible), and free of Bromine (Br) and Antimony (Sb) based flame retardants (Br or Sb do not exceed 0.1% by weight in homogeneous material)

⁽³⁾ MSL, Peak Temp. -- The Moisture Sensitivity Level rating according to the JEDEC industry standard classifications, and peak solder temperature.

Important Information and Disclaimer: The information provided on this page represents TI's knowledge and belief as of the date that it is provided. TI bases its knowledge and belief on information provided by third parties, and makes no representation or warranty as to the accuracy of such information. Efforts are underway to better integrate information from third parties. TI has taken and

continues to take reasonable steps to provide representative and accurate information but may not have conducted destructive testing or chemical analysis on incoming materials and chemicals. TI and TI suppliers consider certain information to be proprietary, and thus CAS numbers and other limited information may not be available for release.

In no event shall TI's liability arising out of such information exceed the total purchase price of the TI part(s) at issue in this document sold by TI to Customer on an annual basis.

TAPE AND REEL INFORMATION
REEL DIMENSIONS

TAPE DIMENSIONS

| | |
|----|---|
| A0 | Dimension designed to accommodate the component width |
| B0 | Dimension designed to accommodate the component length |
| K0 | Dimension designed to accommodate the component thickness |
| W | Overall width of the carrier tape |
| P1 | Pitch between successive cavity centers |

TAPE AND REEL INFORMATION

*All dimensions are nominal

| Device | Package Type | Package Drawing | Pins | SPQ | Reel Diameter (mm) | Reel Width W1 (mm) | A0 (mm) | B0 (mm) | K0 (mm) | P1 (mm) | W (mm) | Pin1 Quadrant |
|---------------|----------------------|-----------------|------|------|--------------------|--------------------|---------|---------|---------|---------|--------|---------------|
| TPA6101A2DGKR | VSSOP | DGK | 8 | 2500 | 330.0 | 12.4 | 5.3 | 3.4 | 1.4 | 8.0 | 12.0 | Q1 |
| TPA6101A2ZQYR | BGA MICROSTAR JUNIOR | ZQY | 15 | 2500 | 330.0 | 8.4 | 2.8 | 2.8 | 1.25 | 4.0 | 8.0 | Q1 |

TAPE AND REEL BOX DIMENSIONS

*All dimensions are nominal

| Device | Package Type | Package Drawing | Pins | SPQ | Length (mm) | Width (mm) | Height (mm) |
|---------------|----------------------|-----------------|------|------|-------------|------------|-------------|
| TPA6101A2DGKR | VSSOP | DGK | 8 | 2500 | 358.0 | 335.0 | 35.0 |
| TPA6101A2ZQYR | BGA MICROSTAR JUNIOR | ZQY | 15 | 2500 | 338.1 | 338.1 | 20.6 |

ZQY (S-PBGA-N15)

PLASTIC BALL GRID ARRAY

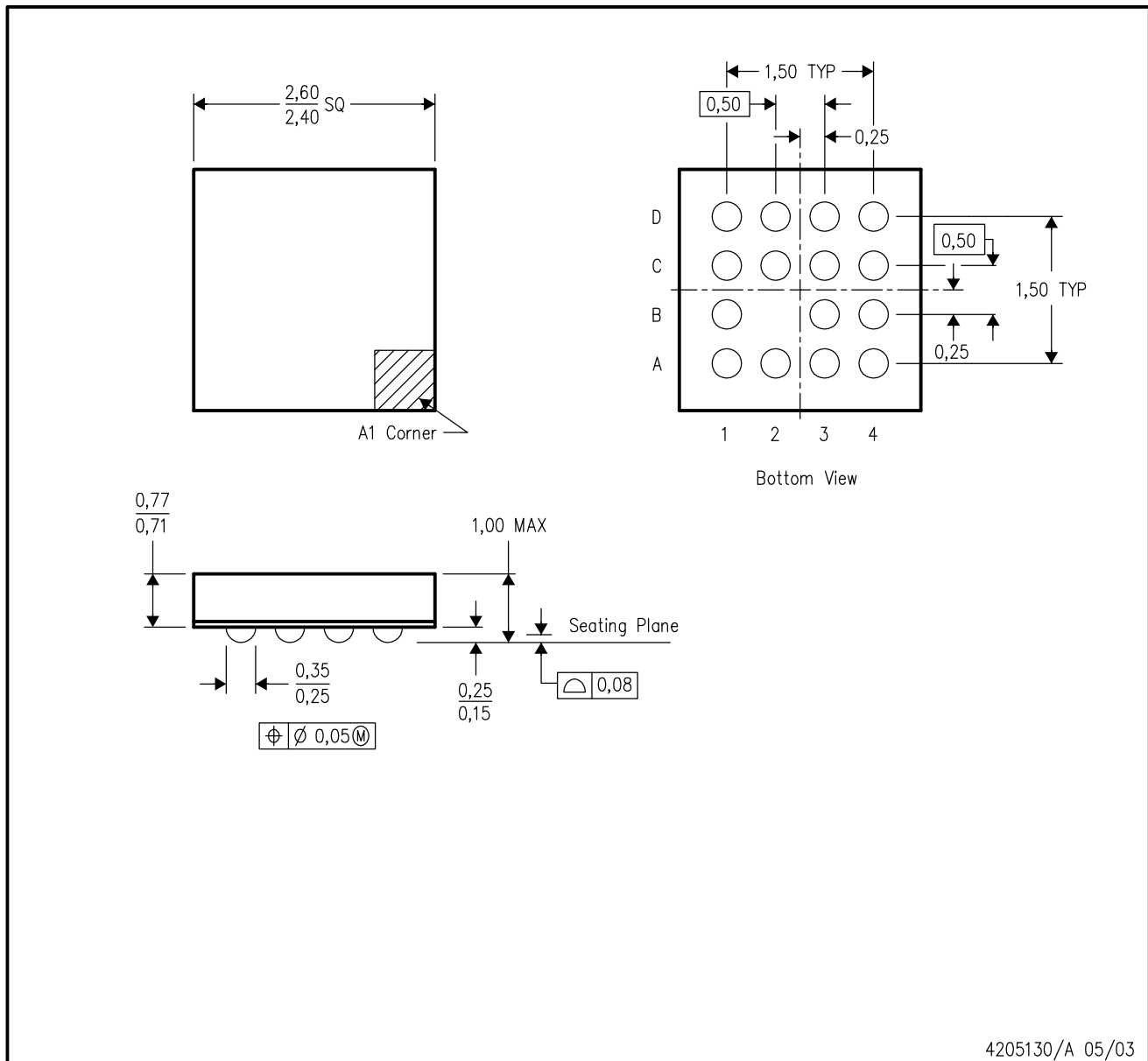

- NOTES:
- All linear dimensions are in millimeters.
 - This drawing is subject to change without notice.
 - MicroStar Junior configuration
 - Falls within JEDEC MO-225
 - This package is lead-free.

DGK (S-PDSO-G8)

PLASTIC SMALL-OUTLINE PACKAGE



4073329/E 05/06

- NOTES:
- A. All linear dimensions are in millimeters.
 - B. This drawing is subject to change without notice.
 - C. Body length does not include mold flash, protrusions, or gate burrs. Mold flash, protrusions, or gate burrs shall not exceed 0.15 per end.
 - D. Body width does not include interlead flash. Interlead flash shall not exceed 0.50 per side.
 - E. Falls within JEDEC MO-187 variation AA, except interlead flash.

D (R-PDSO-G8)

PLASTIC SMALL OUTLINE



- NOTES:
- A. All linear dimensions are in inches (millimeters).
 - B. This drawing is subject to change without notice.
 - C. Body length does not include mold flash, protrusions, or gate burrs. Mold flash, protrusions, or gate burrs shall not exceed 0.006 (0,15) each side.
 - D. Body width does not include interlead flash. Interlead flash shall not exceed 0.017 (0,43) each side.
 - E. Reference JEDEC MS-012 variation AA.

D (R-PDSO-G8)

PLASTIC SMALL OUTLINE



- NOTES:
- A. All linear dimensions are in millimeters.
 - B. This drawing is subject to change without notice.
 - C. Publication IPC-7351 is recommended for alternate designs.
 - D. Laser cutting apertures with trapezoidal walls and also rounding corners will offer better paste release. Customers should contact their board assembly site for stencil design recommendations. Refer to IPC-7525 for other stencil recommendations.
 - E. Customers should contact their board fabrication site for solder mask tolerances between and around signal pads.

IMPORTANT NOTICE

Texas Instruments Incorporated and its subsidiaries (TI) reserve the right to make corrections, enhancements, improvements and other changes to its semiconductor products and services per JESD46C and to discontinue any product or service per JESD48B. Buyers should obtain the latest relevant information before placing orders and should verify that such information is current and complete. All semiconductor products (also referred to herein as "components") are sold subject to TI's terms and conditions of sale supplied at the time of order acknowledgment.

TI warrants performance of its components to the specifications applicable at the time of sale, in accordance with the warranty in TI's terms and conditions of sale of semiconductor products. Testing and other quality control techniques are used to the extent TI deems necessary to support this warranty. Except where mandated by applicable law, testing of all parameters of each component is not necessarily performed.

TI assumes no liability for applications assistance or the design of Buyers' products. Buyers are responsible for their products and applications using TI components. To minimize the risks associated with Buyers' products and applications, Buyers should provide adequate design and operating safeguards.

TI does not warrant or represent that any license, either express or implied, is granted under any patent right, copyright, mask work right, or other intellectual property right relating to any combination, machine, or process in which TI components or services are used. Information published by TI regarding third-party products or services does not constitute a license to use such products or services or a warranty or endorsement thereof. Use of such information may require a license from a third party under the patents or other intellectual property of the third party, or a license from TI under the patents or other intellectual property of TI.

Reproduction of significant portions of TI information in TI data books or data sheets is permissible only if reproduction is without alteration and is accompanied by all associated warranties, conditions, limitations, and notices. TI is not responsible or liable for such altered documentation. Information of third parties may be subject to additional restrictions.

Resale of TI components or services with statements different from or beyond the parameters stated by TI for that component or service voids all express and any implied warranties for the associated TI component or service and is an unfair and deceptive business practice. TI is not responsible or liable for any such statements.

Buyer acknowledges and agrees that it is solely responsible for compliance with all legal, regulatory and safety-related requirements concerning its products, and any use of TI components in its applications, notwithstanding any applications-related information or support that may be provided by TI. Buyer represents and agrees that it has all the necessary expertise to create and implement safeguards which anticipate dangerous consequences of failures, monitor failures and their consequences, lessen the likelihood of failures that might cause harm and take appropriate remedial actions. Buyer will fully indemnify TI and its representatives against any damages arising out of the use of any TI components in safety-critical applications.

In some cases, TI components may be promoted specifically to facilitate safety-related applications. With such components, TI's goal is to help enable customers to design and create their own end-product solutions that meet applicable functional safety standards and requirements. Nonetheless, such components are subject to these terms.

No TI components are authorized for use in FDA Class III (or similar life-critical medical equipment) unless authorized officers of the parties have executed a special agreement specifically governing such use.

Only those TI components which TI has specifically designated as military grade or "enhanced plastic" are designed and intended for use in military/aerospace applications or environments. Buyer acknowledges and agrees that any military or aerospace use of TI components which have **not** been so designated is solely at the Buyer's risk, and that Buyer is solely responsible for compliance with all legal and regulatory requirements in connection with such use.

TI has specifically designated certain components which meet ISO/TS16949 requirements, mainly for automotive use. Components which have not been so designated are neither designed nor intended for automotive use; and TI will not be responsible for any failure of such components to meet such requirements.

Products

| | |
|------------------------|--|
| Audio | www.ti.com/audio |
| Amplifiers | amplifier.ti.com |
| Data Converters | dataconverter.ti.com |
| DLP® Products | www.dlp.com |
| DSP | dsp.ti.com |
| Clocks and Timers | www.ti.com/clocks |
| Interface | interface.ti.com |
| Logic | logic.ti.com |
| Power Mgmt | power.ti.com |
| Microcontrollers | microcontroller.ti.com |
| RFID | www.ti-rfid.com |
| OMAP Mobile Processors | www.ti.com/omap |
| Wireless Connectivity | www.ti.com/wirelessconnectivity |

Applications

| | |
|-------------------------------|--|
| Automotive and Transportation | www.ti.com/automotive |
| Communications and Telecom | www.ti.com/communications |
| Computers and Peripherals | www.ti.com/computers |
| Consumer Electronics | www.ti.com/consumer-apps |
| Energy and Lighting | www.ti.com/energy |
| Industrial | www.ti.com/industrial |
| Medical | www.ti.com/medical |
| Security | www.ti.com/security |
| Space, Avionics and Defense | www.ti.com/space-avionics-defense |
| Video and Imaging | www.ti.com/video |

TI E2E Community e2e.ti.com