



# VERY LOW-POWER, HIGH-SPEED, RAIL-TO-RAIL INPUT AND OUTPUT VOLTAGE-FEEDBACK OPERATIONAL AMPLIFIER

Check for Samples: [THS4281](#)

## FEATURES

- **Very Low Quiescent Current: 750  $\mu$ A (at 5 V)**
- **Rail-to-Rail Input and Output:**
  - **Common-Mode Input Voltage Extends 400 mV Beyond the Rails**
  - **Output Swings Within 150 mV From the Rails**
- **Wide –3-dB Bandwidth at 5 V:**
  - **90 MHz at Gain = +1, 40 MHz at Gain = +2**
- **High Slew Rate: 35 V/ $\mu$ s**
- **Fast Settling Time (2-V Step):**
  - **78 ns to 0.1%**
  - **150 ns to 0.01%**
- **Low Distortion at Gain = +2,  $V_O = 2\text{-}V_{PP}$ , 5 V:**
  - **–91 dBc at 100 kHz, –67 dBc at 1 MHz**
- **Input Offset Voltage: 2.5 mV (Max at +25°C)**
- **Output Current > 30 mA (10- $\Omega$  Load, 5 V)**
- **Low Voltage Noise of 12.5 nV/ $\sqrt{\text{Hz}}$**
- **Supply Voltages: +2.7 V, 3 V, +5 V,  $\pm$ 5 V, +15 V**
- **Packages: SOT23, MSOP, and SOIC**

## APPLICATIONS

- **Portable/Battery-Powered Applications**
- **High Channel Count Systems**
- **ADC Buffer**
- **Active Filters**
- **Current Sensing**

## DESCRIPTION

Fabricated using the BiCom-II process, the THS4281 is a low-power, rail-to-rail input and output, voltage-feedback operational amplifier designed to operate over a wide power-supply range of 2.7-V to 15-V single supply, and  $\pm$ 1.35-V to  $\pm$ 7.5-V dual supply. Consuming only 750  $\mu$ A with a unity gain bandwidth of 90 MHz and a high 35-V/ $\mu$ s slew rate, the THS4281 allows portable or other power-sensitive applications to realize high performance with minimal power. To ensure long battery life in portable applications, the quiescent current is trimmed to be less than 900  $\mu$ A at +25°C, and 1 mA from –40°C to +85°C.

The THS4281 is a true single-supply amplifier with a specified common-mode input range of 400 mV beyond the rails. This allows for high-side current sensing applications without phase reversal concerns. Its output swings to within 40 mV from the rails with 10-k $\Omega$  loads, and 150 mV from the rails with 1-k $\Omega$  loads.

The THS4281 has a good 0.1% settling time of 78 ns, and 0.01% settling time of 150 ns. The low THD of –87 dBc at 100 kHz, coupled with a maximum offset voltage of less than 2.5 mV, makes the THS4281 a good match for high-resolution ADCs sampling less than 2 MSPS.

The THS4281 is offered in a space-saving SOT23-5 package, a small MSOP-8 package, and the industry standard SOIC-8 package.

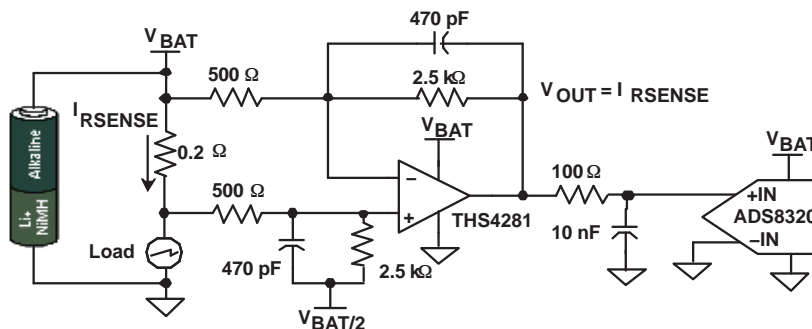

High-Side, Low Power Current-Sensing System



Please be aware that an important notice concerning availability, standard warranty, and use in critical applications of Texas Instruments semiconductor products and disclaimers thereto appears at the end of this data sheet.

FilterPro is a trademark of Texas Instruments.

All other trademarks are the property of their respective owners.



This integrated circuit can be damaged by ESD. Texas Instruments recommends that all integrated circuits be handled with appropriate precautions. Failure to observe proper handling and installation procedures can cause damage.

ESD damage can range from subtle performance degradation to complete device failure. Precision integrated circuits may be more susceptible to damage because very small parametric changes could cause the device not to meet its published specifications.

## ABSOLUTE MAXIMUM RATINGS<sup>(1)</sup>

Over operating free-air temperature range (unless otherwise noted).

		UNIT
Supply voltage, $V_{S-}$ to $V_{S+}$		16.5 V
Input voltage, $V_I$		$\pm V_S \pm 0.5$ V
Differential input voltage, $V_{ID}$		$\pm 2$ V
Output current, $I_O$		$\pm 100$ mA
Continuous power dissipation		See <a href="#">Dissipation Ratings Table</a>
Maximum junction temperature, any condition, <sup>(2)</sup> $T_J$		+150°C
Maximum junction temperature, continuous operation, long-term reliability <sup>(2)</sup> $T_J$		+125°C
Storage temperature range, $T_{stg}$		-65°C to +150°C
ESD ratings	HBM	3500 V
	CDM	1500 V
	MM	100 V

- (1) The absolute maximum ratings under any condition is limited by the constraints of the silicon process. Stresses above these ratings may cause permanent damage. Exposure to absolute maximum conditions for extended periods may degrade device reliability. These are stress ratings only, and functional operation of the device at these or any other conditions beyond those specified is not implied.
- (2) The maximum junction temperature for continuous operation is limited by package constraints. Operation above this temperature may result in reduced reliability and/or lifetime of the device. recommended operating conditions.

## RECOMMENDED OPERATING CONDITIONS

		MIN	MAX	UNIT
Supply voltage, ( $V_{S+}$ and $V_{S-}$ )	Dual supply	$\pm 1.35$	$\pm 8.25$	V
	Single supply	2.7	16.5	

## DISSIPATION RATINGS TABLE PER PACKAGE

PACKAGE	$\theta_{JC}$ (°C/W)	$\theta_{JA}$ <sup>(1)</sup> (°C/W)	POWER RATING <sup>(2)</sup>	
			$T_A < +25^\circ\text{C}$	$T_A = +85^\circ\text{C}$
DBV (5)	55	255.4	391 mW	156 mW
D (8)	38.3	97.5	1.02 W	410 mW
DGK (8)	71.5	180.8	553 mW	221 mW

- (1) This data was taken using the JEDEC standard High-K test PCB.
- (2) Power rating is determined with a junction temperature of +125°C. This is the point where distortion starts to substantially increase. Thermal management of the final PCB should strive to keep the junction temperature at or below +125°C for best performance and long term reliability.

**PACKAGING/ORDERING INFORMATION<sup>(1)</sup>**

PACKAGED DEVICES	DEVICE MARKING	PACKAGE TYPE	TRANSPORT MEDIA, QUANTITY
THS4281DBVT	AON	SOT23 - 5	Tape and Reel, 250
THS4281DBVR			Tape and Reel, 3000
THS4281D	—	SOIC - 8	Rails, 75
THS4281DR			Tape and Reel, 2500
THS4281DGK	AOO	MSOP - 8	Rails, 75
THS4281DGKR			Tape and Reel, 2500

(1) For the most current package and ordering information, see the Package Option Addendum at the end of this document, or see the TI web site at [www.ti.com](http://www.ti.com).

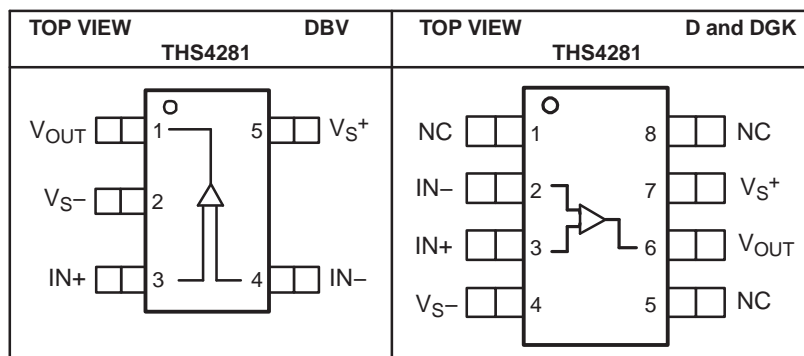
**PIN CONFIGURATIONS**

**NOTE:** NC indicates there is no internal connection to these pins.

**ELECTRICAL CHARACTERISTICS,  $V_S = 3\text{ V}$  ( $V_{S+} = 3\text{ V}$ ,  $V_{S-} = \text{GND}$ )**At  $G = +2$ ,  $R_F = 2.49\text{ k}\Omega$ , and  $R_L = 1\text{ k}\Omega$  to  $1.5\text{ V}$ , unless otherwise noted

PARAMETER	CONDITIONS	TYP	OVER TEMPERATURE				UNITS	MIN/ MAX
		+25°C	+25°C	0°C to +70°C	-40°C to +85°C			
<b>AC PERFORMANCE</b>								
Small-Signal Bandwidth	$G = +1$ , $V_O = 100\text{ mV}_{PP}$ , $R_F = 34\ \Omega$	83					MHz	Typ
	$G = +2$ , $V_O = 100\text{ mV}_{PP}$ , $R_F = 1.65\text{ k}\Omega$	40					MHz	Typ
	$G = +5$ , $V_O = 100\text{ mV}_{PP}$ , $R_F = 1.65\text{ k}\Omega$	8					MHz	Typ
	$G = +10$ , $V_O = 100\text{ mV}_{PP}$ , $R_F = 1.65\text{ k}\Omega$	3.8					MHz	Typ
0.1-dB Flat Bandwidth	$G = +2$ , $V_O = 100\text{ mV}_{PP}$ , $R_F = 1.65\text{ k}\Omega$	20					MHz	Typ
Full-Power Bandwidth	$G = +2$ , $V_O = 2\text{ V}_{PP}$	8					MHz	Typ
Slew Rate	$G = +1$ , $V_O = 2\text{-V Step}$	26					V/ $\mu\text{s}$	Typ
	$G = -1$ , $V_O = 2\text{-V Step}$	27					V/ $\mu\text{s}$	Typ
Settling time to 0.1%	$G = -1$ , $V_O = 1\text{-V Step}$	80					ns	Typ
Settling time to 0.01%	$G = -1$ , $V_O = 1\text{-V Step}$	155					ns	Typ
Rise/Fall Times	$G = +1$ , $V_O = 2\text{-V Step}$	55					ns	Typ
Harmonic Distortion	$G = +2$ , $V_O = 2\text{ V}_{PP}$							
Second Harmonic Distortion	$f = 1\text{ MHz}$ , $R_L = 1\text{ k}\Omega$	-52					dBc	Typ
Third Harmonic Distortion		-52					dBc	Typ
Second Harmonic Distortion	$f = 100\text{ kHz}$ , $R_L = 1\text{ k}\Omega$	-69					dBc	Typ
Third Harmonic Distortion		-71					dBc	Typ
THD + N	$V_O = 1\text{ V}_{PP}$ , $f = 10\text{ kHz}$	0.003					%	Typ
	$V_O = 2\text{ V}_{PP}$ , $f = 10\text{ kHz}$	0.03					%	Typ
Differential Gain (NTSC/PAL)	$G = +2$ , $R_L = 150\ \Omega$	0.05/0.08					%	Typ
Differential Phase (NTSC/PAL)		0.25/0.35					°	Typ
Input Voltage Noise	$f = 100\text{ kHz}$	12.5					nA/ $\sqrt{\text{Hz}}$	Typ
Input Current Noise	$f = 100\text{ kHz}$	1.5					pA/ $\sqrt{\text{Hz}}$	Typ
<b>DC PERFORMANCE</b>								
Open-Loop Voltage Gain (AOL)		95					dB	Typ
Input Offset Voltage	$V_{CM} = 1.5\text{ V}$	0.5	2.5	3.5	3.5		mV	Max
Average Offset Voltage Drift				$\pm 7$	$\pm 7$		$\mu\text{V}/^\circ\text{C}$	Typ
Input Bias Current		0.5	0.8	1	1		$\mu\text{A}$	Max
Average Bias Current Drift				$\pm 2$	$\pm 2$		nA/ $^\circ\text{C}$	Typ
Input Offset Current		0.1	0.4	0.5	0.5		$\mu\text{A}$	Max
Average Offset Current Drift			$\pm 2$	$\pm 2$		nA/ $^\circ\text{C}$	Typ	
<b>INPUT CHARACTERISTICS</b>								
Common-Mode Input Range		-0.4/3.4	-0.3/3.3	-0.1/3.1	-0.1/3.1		V	Min
Common-Mode Rejection Ratio	$V_{CM} = 0\text{ V to }3\text{ V}$	92	75	70	70		dB	Min
Input Resistance	Common-mode	100					M $\Omega$	Typ
Input Capacitance	Common-mode/Differential	0.8/1.2					pF	Typ

**ELECTRICAL CHARACTERISTICS,  $V_S = 3\text{ V}$  ( $V_{S+} = 3\text{ V}$ ,  $V_{S-} = \text{GND}$ ) (continued)**

 At  $G = +2$ ,  $R_F = 2.49\text{ k}\Omega$ , and  $R_L = 1\text{ k}\Omega$  to  $1.5\text{ V}$ , unless otherwise noted

PARAMETER	CONDITIONS	TYP	OVER TEMPERATURE				UNITS	MIN/ MAX
		+25°C	+25°C	0°C to +70°C	-40°C to +85°C			
<b>OUTPUT CHARACTERISTICS</b>								
Output Voltage Swing	$R_L = 10\text{ k}\Omega$	0.04/2.96					V	Typ
	$R_L = 1\text{ k}\Omega$	0.1/2.9	0.14/2.86	0.2/2.8	0.2/2.8		V	Min
Output Current (Sourcing)	$R_L = 10\ \Omega$	23	18	15	15		mA	Min
Output Current (Sinking)	$R_L = 10\ \Omega$	29	22	19	19		mA	Min
Output Impedance	$f = 1\text{ MHz}$	1					$\Omega$	Typ
<b>POWER SUPPLY</b>								
Maximum Operating Voltage		3	16.5	16.5	16.5		V	Max
Minimum Operating Voltage		3	2.7	2.7	2.7		V	Min
Maximum Quiescent Current		0.75	0.9	0.98	1.0		mA	Max
Minimum Quiescent Current		0.75	0.6	0.57	0.55		mA	Min
Power-Supply Rejection (+PSRR)	$V_{S+} = 3.25\text{ V to } 2.75\text{ V}$ , $V_{S-} = 0\text{ V}$	90	70	65	65		dB	Min
Power-Supply Rejection (-PSRR)	$V_{S+} = 3\text{ V}$ , $V_{S-} = 0\text{ V to } 0.65\text{ V}$	90	70	65	65		dB	Min

**ELECTRICAL CHARACTERISTICS,  $V_S = 5\text{ V}$  ( $V_{S+} = 5\text{ V}$ ,  $V_{S-} = \text{GND}$ )**At  $G = +2$ ,  $R_F = 2.49\text{ k}\Omega$ , and  $R_L = 1\text{ k}\Omega$  to  $2.5\text{ V}$ , unless otherwise noted

PARAMETER	CONDITIONS	TYP	OVER TEMPERATURE				UNITS	MIN/ MAX	
		+25°C	+25°C	0°C to +70°C	-40°C to +85°C				
<b>AC PERFORMANCE</b>									
Small-Signal Bandwidth	$G = +1$ , $V_O = 100\text{ mV}_{PP}$ , $R_F = 34\ \Omega$	90					MHz	Typ	
	$G = +2$ , $V_O = 100\text{ mV}_{PP}$ , $R_F = 2\text{ k}\Omega$	40					MHz	Typ	
	$G = +5$ , $V_O = 100\text{ mV}_{PP}$ , $R_F = 2\text{ k}\Omega$	8					MHz	Typ	
	$G = +10$ , $V_O = 100\text{ mV}_{PP}$ , $R_F = 2\text{ k}\Omega$	3.8					MHz	Typ	
0.1-dB Flat Bandwidth	$G = +2$ , $V_O = 100\text{ mV}_{PP}$ , $R_F = 2\text{ k}\Omega$	20					MHz	Typ	
Full-Power Bandwidth	$G = +2$ , $V_O = 2\text{ V}_{PP}$	9					MHz	Typ	
Slew Rate	$G = +1$ , $V_O = 2\text{-V Step}$	31					V/ $\mu\text{s}$	Typ	
	$G = -1$ , $V_O = 2\text{-V Step}$	34					V/ $\mu\text{s}$	Typ	
Settling Time to 0.1%	$G = -1$ , $V_O = 2\text{-V Step}$	78					ns	Typ	
Settling Time to 0.01%	$G = -1$ , $V_O = 2\text{-V Step}$	150					ns	Typ	
Rise/Fall Times	$G = +1$ , $V_O = 2\text{-V Step}$	48					ns	Typ	
Harmonic Distortion	$G = +2$ , $V_O = 2\text{ V}_{PP}$								
	Second Harmonic Distortion Third Harmonic Distortion	$f = 1\text{ MHz}$ , $R_L = 1\text{ k}\Omega$	-67 -76					dBc dBc	Typ Typ
Second Harmonic Distortion Third Harmonic Distortion	$f = 100\text{ kHz}$ , $R_L = 1\text{ k}\Omega$								
			-92 -106					dBc dBc	Typ Typ
THD + N	$V_O = 2\text{ V}_{PP}$ , $f = 10\text{ kHz}$	0.0009						%	Typ
	$V_O = 4\text{ V}_{PP}$ , $f = 10\text{ kHz}$	0.0005						%	Typ
Differential Gain (NTSC/PAL)	$G = +2$ , $R_L = 150\ \Omega$	0.11/0.17						%	Typ
Differential Phase (NTSC/PAL)		0.11/0.14						°	Typ
Input Voltage Noise	$f = 100\text{ kHz}$	12.5						nV/ $\sqrt{\text{Hz}}$	Typ
Input Current Noise	$f = 100\text{ kHz}$	1.5						pA/ $\sqrt{\text{Hz}}$	Typ
<b>DC PERFORMANCE</b>									
Open-Loop Voltage Gain (AOL)		105	85	80	80			dB	Min
Input Offset Voltage Average Offset Voltage Drift	$V_{CM} = 2.5\text{ V}$	0.5	2.5	3.5	3.5			mV	Max
				$\pm 7$	$\pm 7$			$\mu\text{V}/^\circ\text{C}$	Typ
Input Bias Current Average Bias Current Drift		0.5	0.8	1	1			$\mu\text{A}$	Max
				$\pm 2$	$\pm 2$			nA/ $^\circ\text{C}$	Typ
Input Offset Current Average Offset Current Drift		0.1	0.4	0.5	0.5			$\mu\text{A}$	Max
				$\pm 2$	$\pm 2$			nA/ $^\circ\text{C}$	Typ

**ELECTRICAL CHARACTERISTICS,  $V_S = 5\text{ V}$  ( $V_{S+} = 5\text{ V}$ ,  $V_{S-} = \text{GND}$ ) (continued)**

 At  $G = +2$ ,  $R_F = 2.49\text{ k}\Omega$ , and  $R_L = 1\text{ k}\Omega$  to  $2.5\text{ V}$ , unless otherwise noted

PARAMETER	CONDITIONS	TYP	OVER TEMPERATURE				UNITS	MIN/ MAX
		+25°C	+25°C	0°C to +70°C	-40°C to +85°C			
<b>INPUT CHARACTERISTICS</b>								
Common-Mode Input Range		-0.4/5.4	-0.3/5.3	-0.1/5.1	-0.1/5.1	V	Min	
Common-Mode Rejection Ratio	$V_{CM} = 0\text{ V to } 5\text{ V}$	100	85	80	80	dB	Min	
Input Resistance	Common-mode	100				M $\Omega$	Typ	
Input Capacitance	Common-mode/Differential	0.8/1.2				pF	Typ	
<b>OUTPUT CHARACTERISTICS</b>								
Output Voltage Swing	$R_L = 10\text{ k}\Omega$	0.04/4.96				V	Typ	
	$R_L = 1\text{ k}\Omega$	0.15/4.85	0.2/4.8	0.25/4.75	0.25/4.75	V	Min	
Output Current (Sourcing)	$R_L = 10\ \Omega$	33	24	20	20	mA	Min	
Output Current (Sinking)	$R_L = 10\ \Omega$	44	30	25	25	mA	Min	
Output Impedance	$f = 1\text{ MHz}$	1				$\Omega$	Typ	
<b>POWER SUPPLY</b>								
Maximum Operating Voltage		5	16.5	16.5	16.5	V	Max	
Minimum Operating Voltage		5	2.7	2.7	2.7	V	Min	
Maximum Quiescent Current		0.75	0.9	0.98	1.0	mA	Max	
Minimum Quiescent Current		0.75	0.6	0.57	0.55	mA	Min	
Power-Supply Rejection (+PSRR)	$V_{S+} = 5.5\text{ V to } 4.5\text{ V}$ , $V_{S-} = 0\text{ V}$	100	80	75	75	dB	Min	
Power-Supply Rejection (-PSRR)	$V_{S+} = 5\text{ V}$ , $V_{S-} = 0\text{ V to } 1.0\text{ V}$	100	80	75	75	dB	Min	

**ELECTRICAL CHARACTERISTICS,  $V_S = \pm 5\text{ V}$** At  $G = +2$ ,  $R_F = 2.49\text{ k}\Omega$ , and  $R_L = 1\text{ k}\Omega$ , unless otherwise noted

PARAMETER	CONDITIONS	TYP	OVER TEMPERATURE				UNITS	MIN/ MAX	
		+25°C	+25°C	0°C to +70°C	-40°C to +85°C				
<b>AC PERFORMANCE</b>									
Small-Signal Bandwidth	$G = +1$ , $V_O = 100\text{ mV}_{PP}$ , $R_F = 34\ \Omega$	95					MHz	Typ	
	$G = +2$ , $V_O = 100\text{ mV}_{PP}$	40					MHz	Typ	
	$G = +5$ , $V_O = 100\text{ mV}_{PP}$	8					MHz	Typ	
	$G = +10$ , $V_O = 100\text{ mV}_{PP}$	3.8					MHz	Typ	
0.1-dB Flat Bandwidth	$G = +2$ , $V_O = 100\text{ mV}_{PP}$	20					MHz	Typ	
Full-Power Bandwidth	$G = +1$ , $V_O = 2\text{ V}_{PP}$	9.5					MHz	Typ	
Slew Rate	$G = +1$ , $V_O = 2\text{-V Step}$	35					V/ $\mu\text{s}$	Typ	
	$G = -1$ , $V_O = 2\text{-V Step}$	35					V/ $\mu\text{s}$	Typ	
Settling Time to 0.1%	$G = -1$ , $V_O = 2\text{-V Step}$	78					ns	Typ	
Settling Time to 0.01%	$G = -1$ , $V_O = 2\text{-V Step}$	140					ns	Typ	
Rise/Fall Times	$G = +1$ , $V_O = 2\text{-V Step}$	45					ns	Typ	
Harmonic Distortion	$G = +2$ , $V_O = 2\text{ V}_{PP}$								
Second Harmonic Distortion	$f = 1\text{ MHz}$ , $R_L = 1\text{ k}\Omega$	-69					dBc	Typ	
Third Harmonic Distortion		-76					dBc	Typ	
Second Harmonic Distortion	$f = 100\text{ kHz}$ , $R_L = 1\text{ k}\Omega$	-93					dBc	Typ	
Third Harmonic Distortion		-107					dBc	Typ	
THD + N	$V_O = 2\text{ V}_{PP}$ , $f = 10\text{ kHz}$	0.0009					%	Typ	
	$V_O = 8\text{ V}_{PP}$ , $f = 10\text{ kHz}$	0.0003					%	Typ	
Differential Gain (NTSC/PAL)	$G = +2$ , $R_L = 150\ \Omega$	0.03/0.03					%	Typ	
Differential Phase (NTSC/PAL)		0.08/0.1					°	Typ	
Input Voltage Noise	$f = 100\text{ kHz}$	12.5					nV/ $\sqrt{\text{Hz}}$	Typ	
Input Current Noise	$f = 100\text{ kHz}$	1.5					pA/ $\sqrt{\text{Hz}}$	Typ	
<b>DC PERFORMANCE</b>									
Open-Loop Voltage Gain (AOL)		108	90	85	85		dB	Min	
Input Offset Voltage	$V_{CM} = 0\text{ V}$	0.5	2.5	3.5	3.5		mV	Max	
Average Offset Voltage Drift					$\pm 7$	$\pm 7$		$\mu\text{V}/^\circ\text{C}$	Typ
Input Bias Current		0.5	0.8	1	1		$\mu\text{A}$	Max	
Average Bias Current Drift					$\pm 2$	$\pm 2$		nA/ $^\circ\text{C}$	Typ
Input Offset Current		0.1	0.4	0.5	0.5		$\mu\text{A}$	Max	
Average Offset Current Drift					$\pm 2$	$\pm 2$		nA/ $^\circ\text{C}$	Typ
<b>INPUT CHARACTERISTICS</b>									
Common-Mode Input Range		$\pm 5.4$	$\pm 5.3$	$\pm 5.1$	$\pm 5.1$		V	Min	
Common-Mode Rejection Ratio	$V_{CM} = -5\text{ V to } +5\text{ V}$	107	90	85	85		dB	Min	
Input Resistance	Common-mode	100					M $\Omega$	Typ	
Input Capacitance	Common-mode/Differential	0.8/1.2					pF	Typ	
<b>OUTPUT CHARACTERISTICS</b>									
Output Voltage Swing	$R_L = 10\text{ k}\Omega$	$\pm 4.93$					V	Typ	
	$R_L = 1\text{ k}\Omega$	$\pm 4.8$	$\pm 4.6$	$\pm 4.5$	$\pm 4.5$		V	Min	
Output Current (Sourcing)	$R_L = 10\ \Omega$	48	35	30	30		mA	Min	
Output Current (Sinking)	$R_L = 10\ \Omega$	60	45	40	40		mA	Min	
Output Impedance	$f = 1\text{ MHz}$	1					$\Omega$	Typ	



**ELECTRICAL CHARACTERISTICS,  $V_S = \pm 5\text{ V}$  (continued)**

 At  $G = +2$ ,  $R_F = 2.49\text{ k}\Omega$ , and  $R_L = 1\text{ k}\Omega$ , unless otherwise noted

PARAMETER	CONDITIONS	TYP	OVER TEMPERATURE				UNITS	MIN/ MAX
		+25°C	+25°C	0°C to +70°C	-40°C to +85°C			
<b>POWER SUPPLY</b>								
Maximum Operating Voltage		±5	±8.25	±8.25	±8.25	V	Max	
Minimum Operating Voltage		±5	±1.35	±1.35	±1.35	V	Min	
Maximum Quiescent Current		0.8	0.93	1.0	1.05	mA	Max	
Minimum Quiescent Current		0.8	0.67	0.62	0.6	mA	Min	
Power-Supply Rejection (+PSRR)	$V_{S+} = 5.5\text{ V to } 4.5\text{ V}$ , $V_{S-} = 5.0\text{ V}$	100	80	75	75	dB	Min	
Power-Supply Rejection (-PSRR)	$V_{S+} = 5\text{ V}$ , $V_{S-} = -5.5\text{ V to } -4.5\text{ V}$	100	80	75	75	dB	Min	

**TYPICAL CHARACTERISTICS**

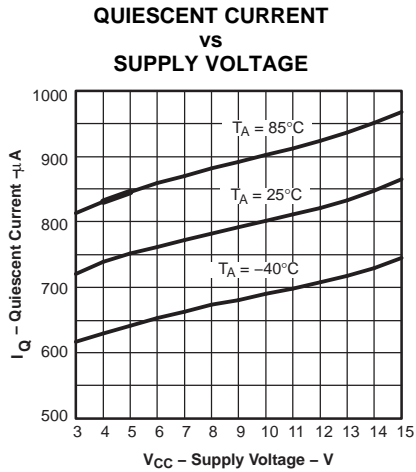

Figure 1.

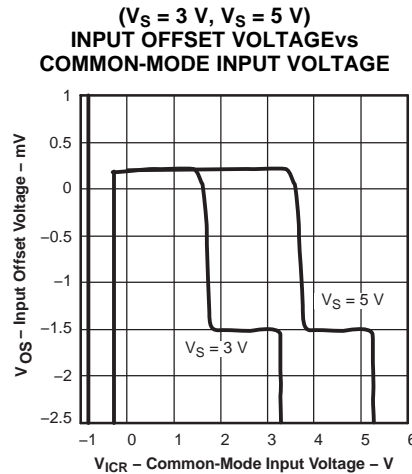

Figure 2.

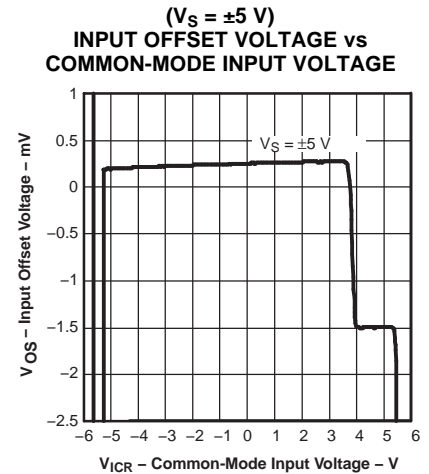

Figure 3.

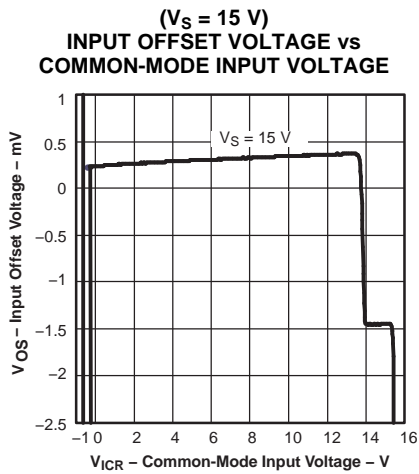

Figure 4.

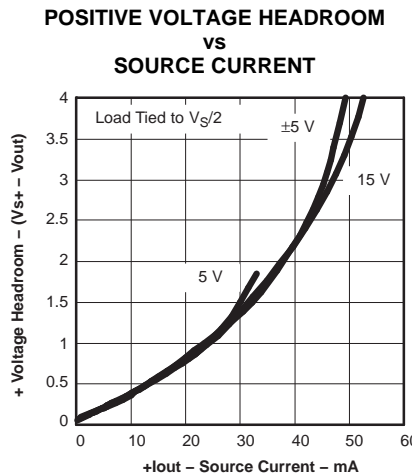

Figure 5.

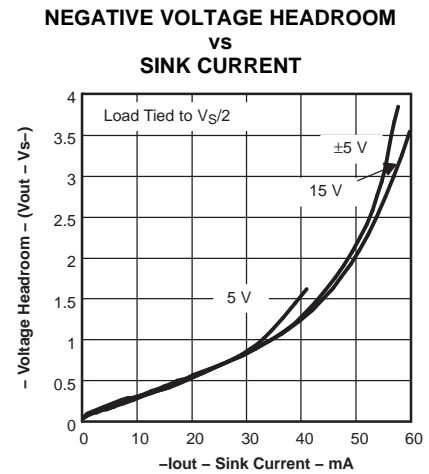

Figure 6.

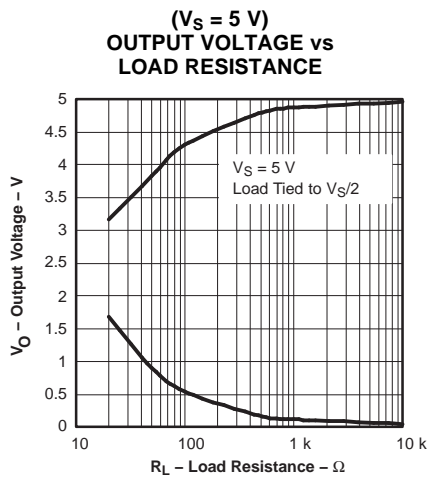

Figure 7.

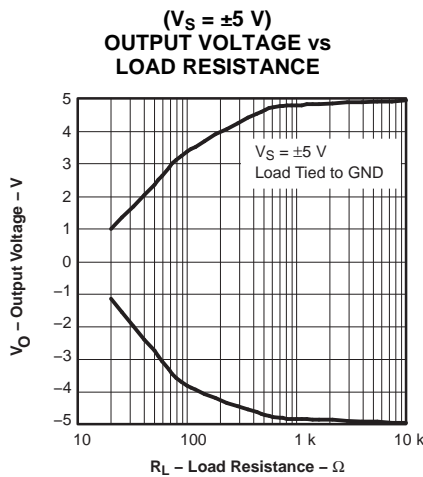

Figure 8.

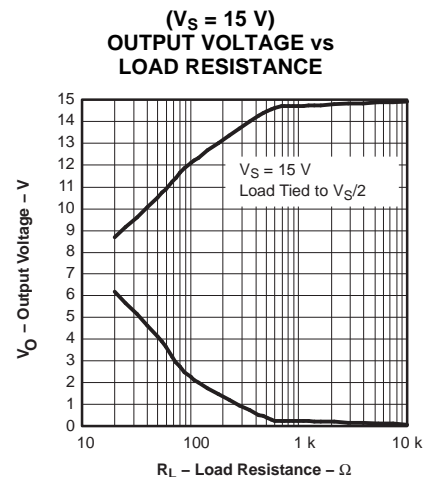

Figure 9.

TYPICAL CHARACTERISTICS (continued)

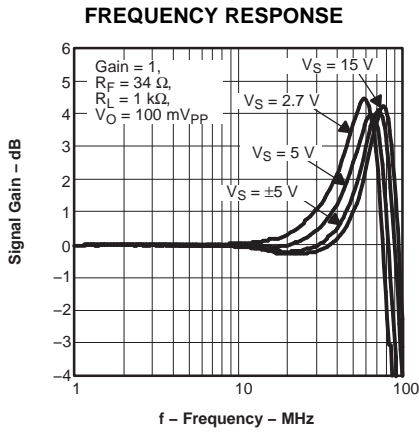

Figure 10.

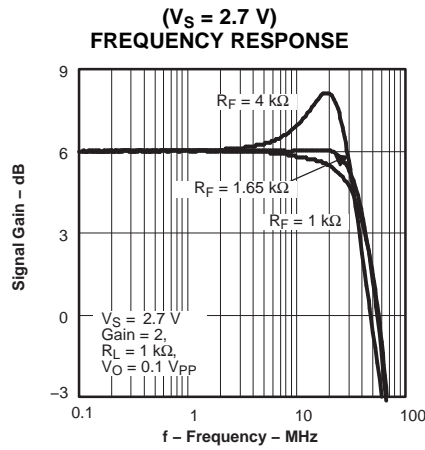

Figure 11.

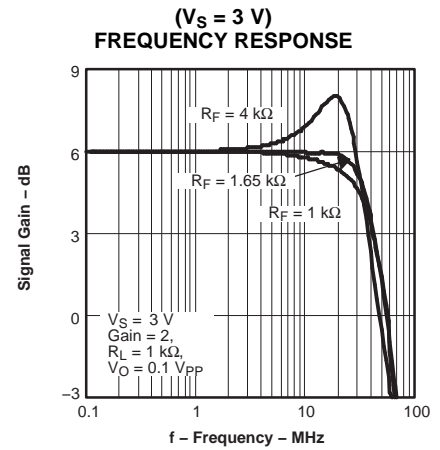

Figure 12.

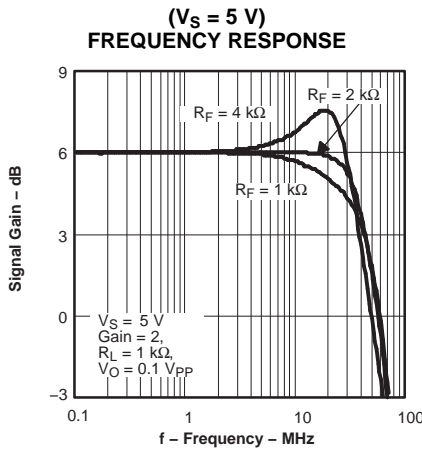

Figure 13.

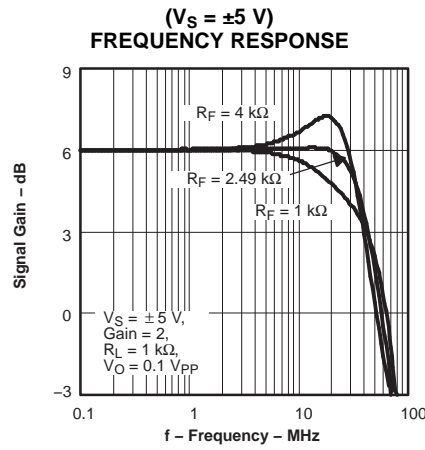

Figure 14.

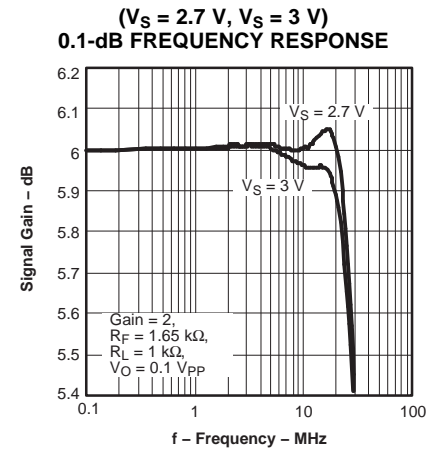

Figure 15.

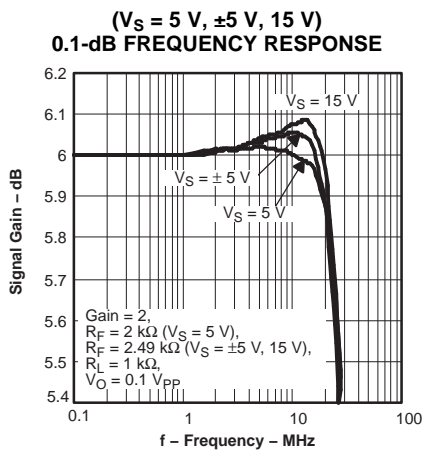

Figure 16.

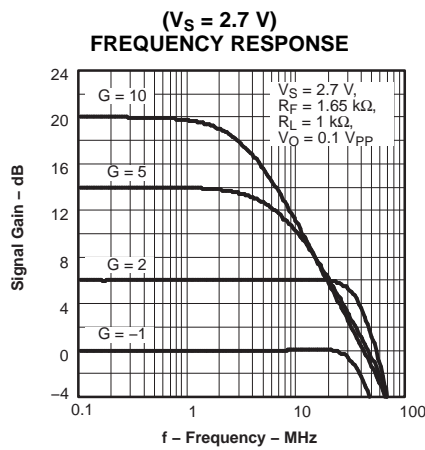

Figure 17.

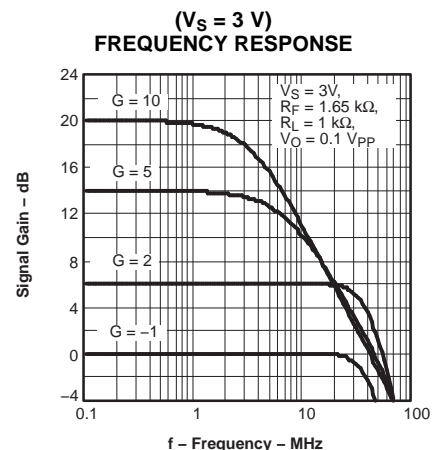

Figure 18.

TYPICAL CHARACTERISTICS (continued)

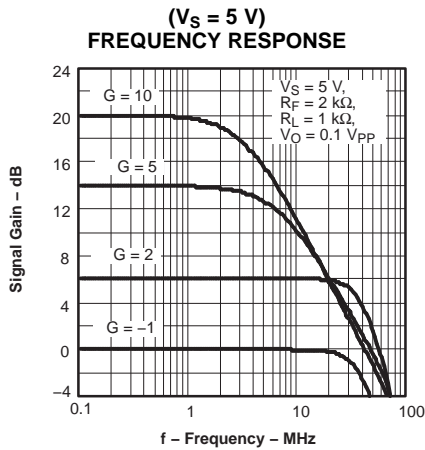

Figure 19.

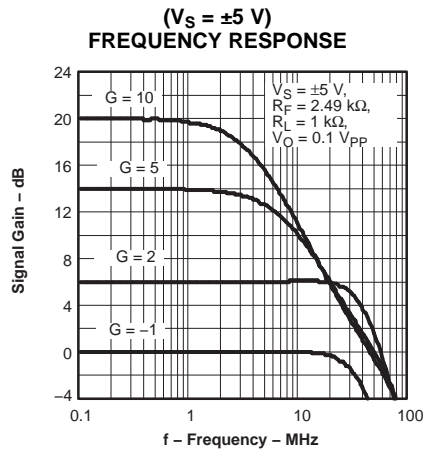

Figure 20.

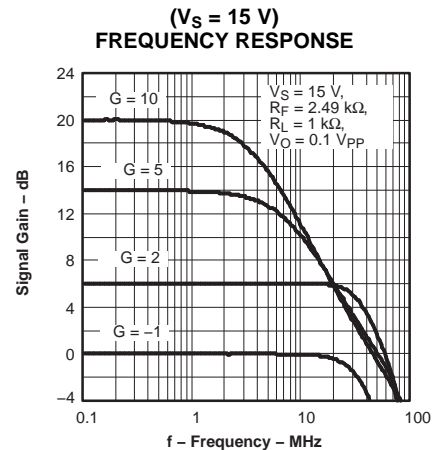

Figure 21.

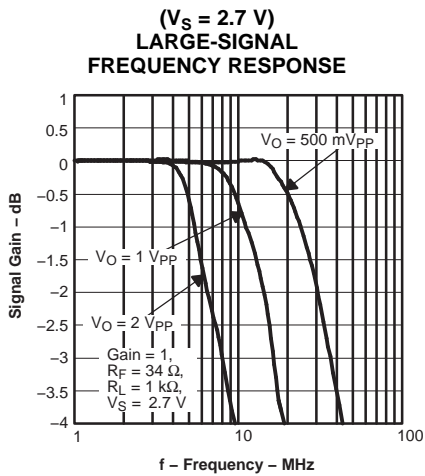

Figure 22.

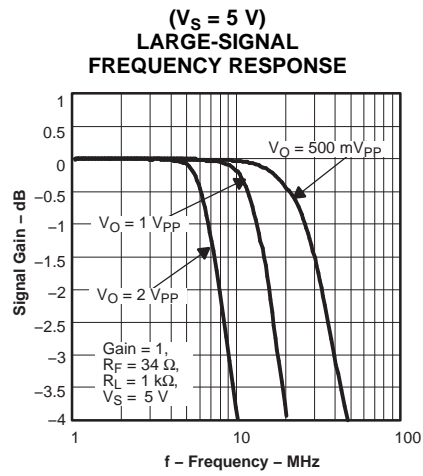

Figure 23.

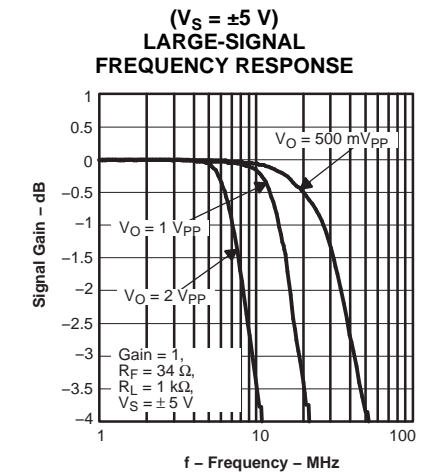

Figure 24.

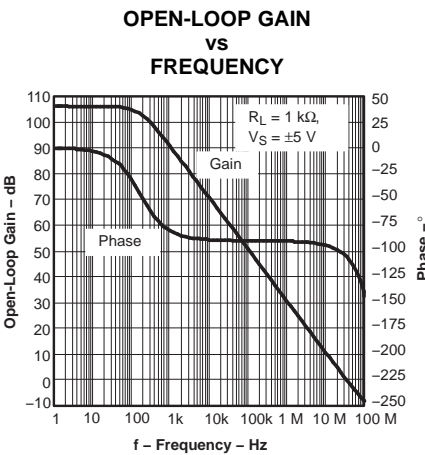

Figure 25.

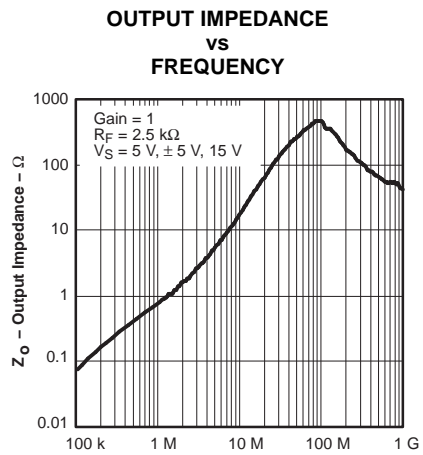

Figure 26.

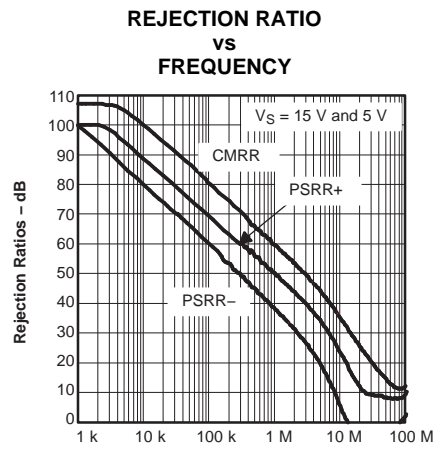

Figure 27.

TYPICAL CHARACTERISTICS (continued)

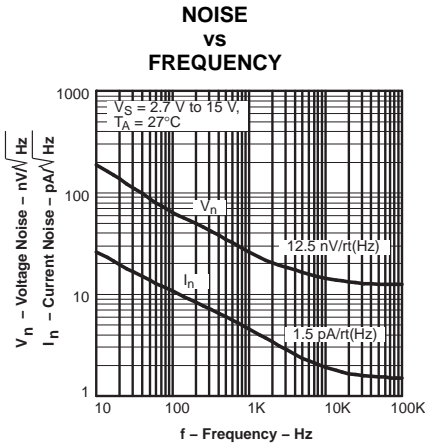

Figure 28.

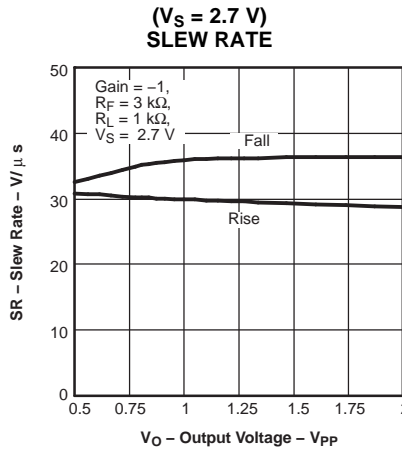

Figure 29.

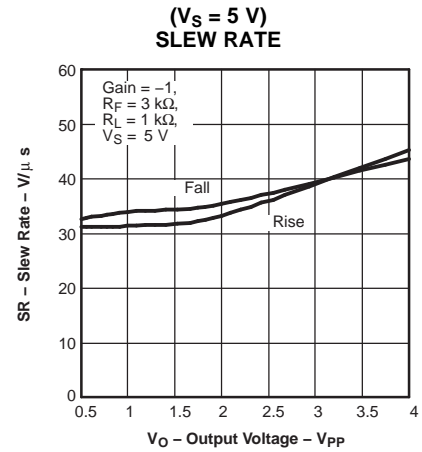

Figure 30.

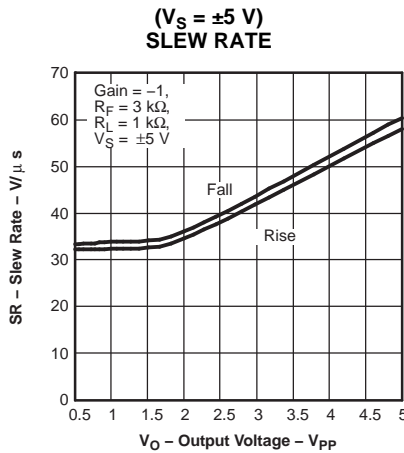

Figure 31.

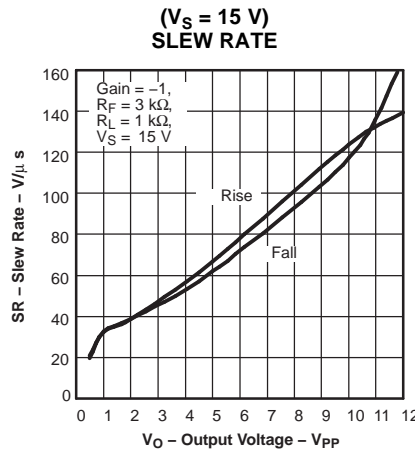

Figure 32.

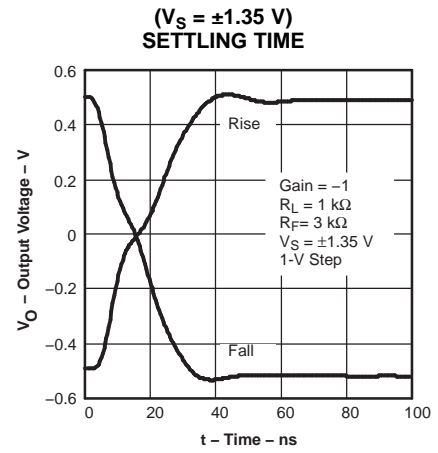

Figure 33.

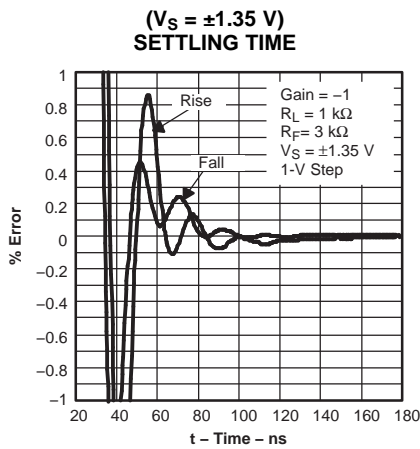

Figure 34.

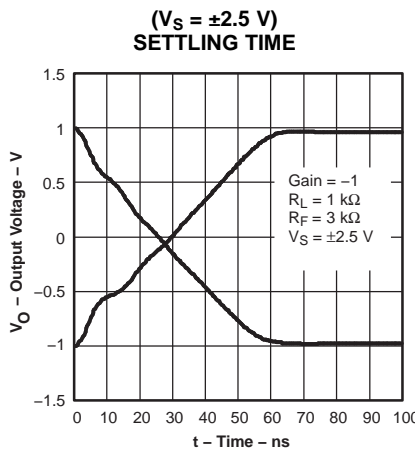

Figure 35.

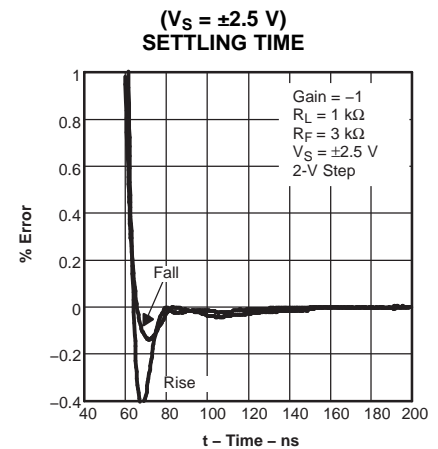

Figure 36.

TYPICAL CHARACTERISTICS (continued)

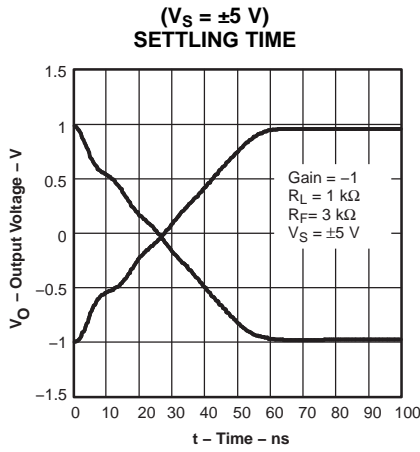

Figure 37.

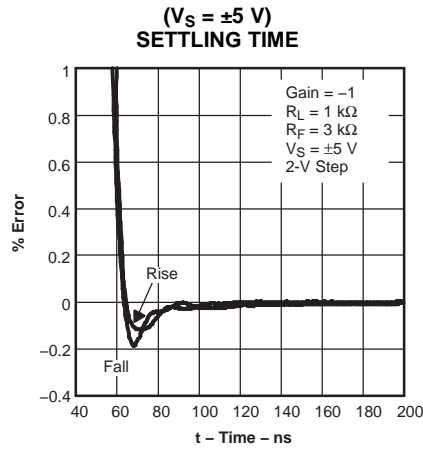

Figure 38.

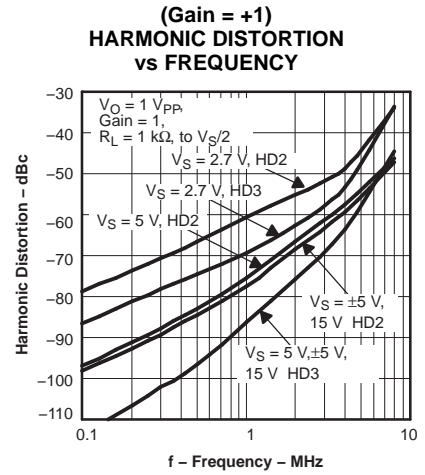

Figure 39.

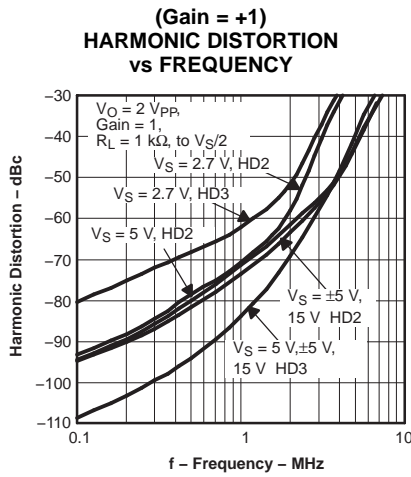

Figure 40.

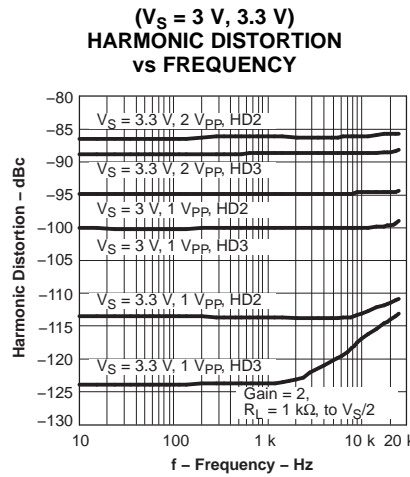

Figure 41.

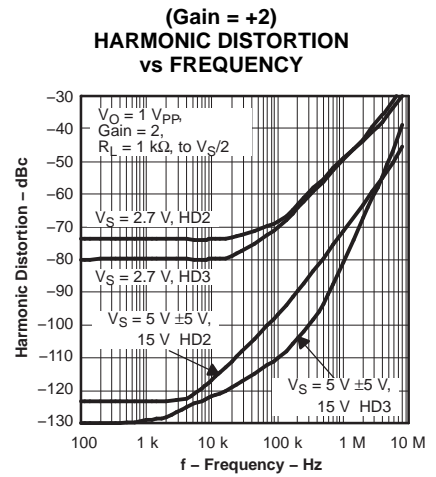

Figure 42.

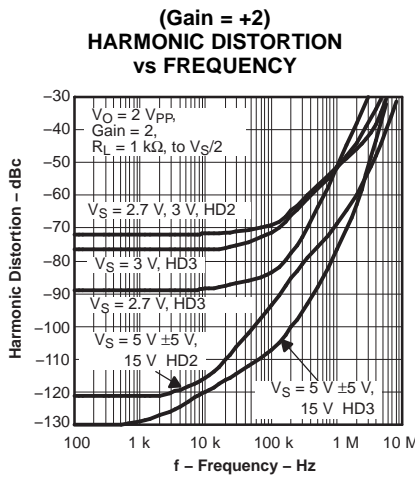

Figure 43.

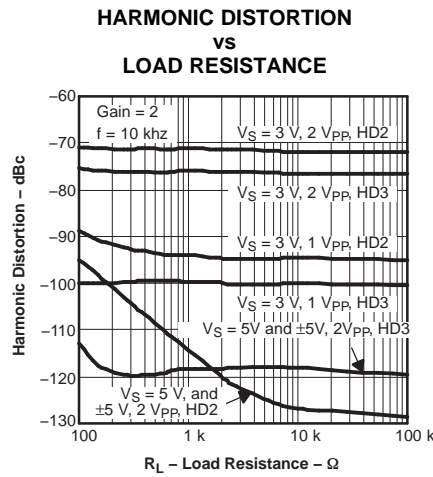

Figure 44.

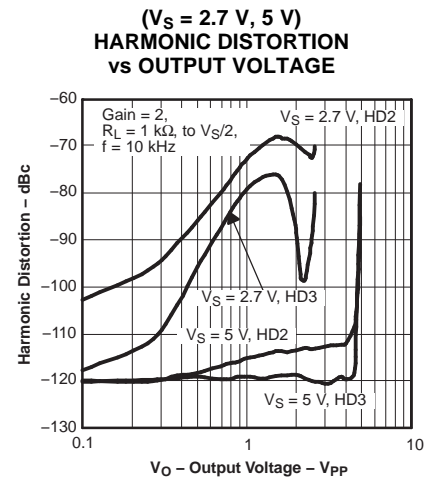

Figure 45.

TYPICAL CHARACTERISTICS (continued)

( $V_S = 3\text{ V}, \pm 5\text{ V}$ )  
HARMONIC DISTORTION  
vs OUTPUT VOLTAGE

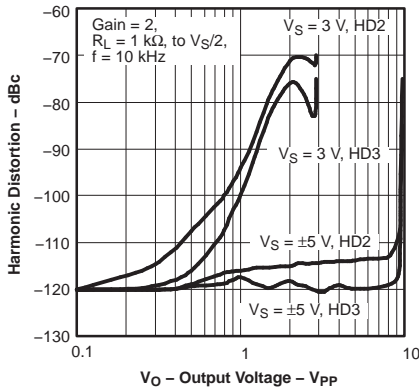

Figure 46.

( $V_S = 3.3\text{ V}, 15\text{ V}$ )  
HARMONIC DISTORTION  
vs OUTPUT VOLTAGE

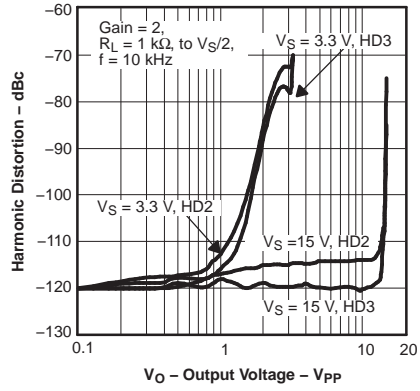

Figure 47.

( $V_S = 2.7\text{ V}$ )  
TOTAL HARMONIC DISTORTION + NOISE  
vs FREQUENCY

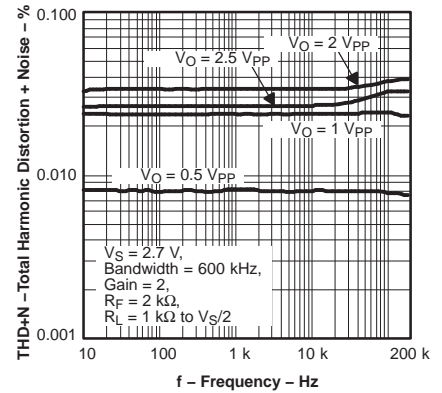

Figure 48.

( $V_S = 3\text{ V}$ )  
TOTAL HARMONIC DISTORTION + NOISE  
vs FREQUENCY

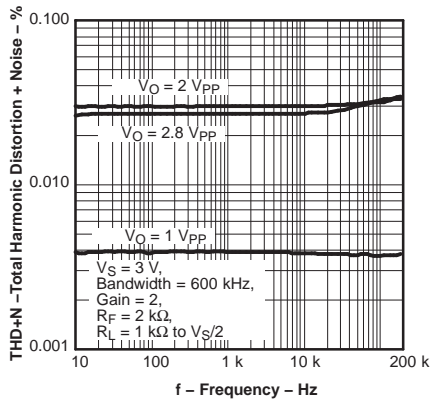

Figure 49.

( $V_S = 5\text{ V}$ )  
TOTAL HARMONIC DISTORTION + NOISE  
vs FREQUENCY

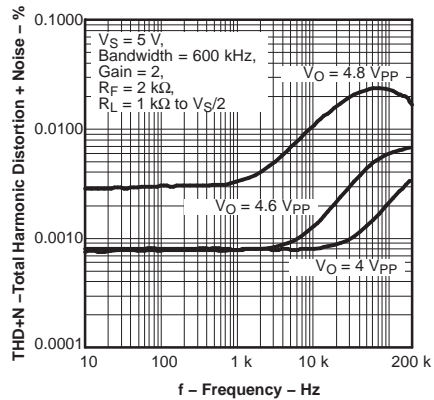

Figure 50.

( $V_S = \pm 5\text{ V}$ )  
TOTAL HARMONIC DISTORTION + NOISE  
vs FREQUENCY

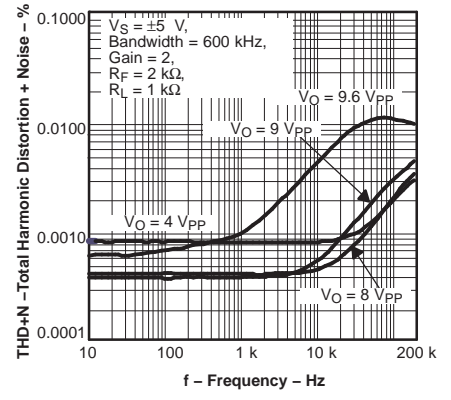

Figure 51.

( $V_S = 15\text{ V}$ )  
TOTAL HARMONIC DISTORTION + NOISE  
vs FREQUENCY

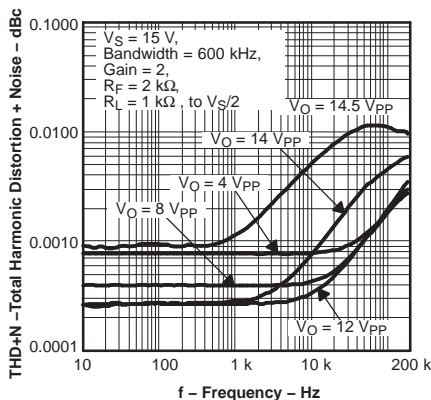

Figure 52.

( $f = 1\text{ kHz}$ )  
TOTAL HARMONIC DISTORTION + NOISE  
vs OUTPUT VOLTAGE

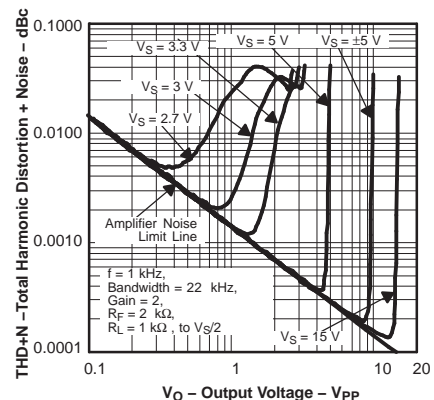

Figure 53.

( $f = 10\text{ kHz}$ )  
TOTAL HARMONIC DISTORTION + NOISE  
vs OUTPUT VOLTAGE

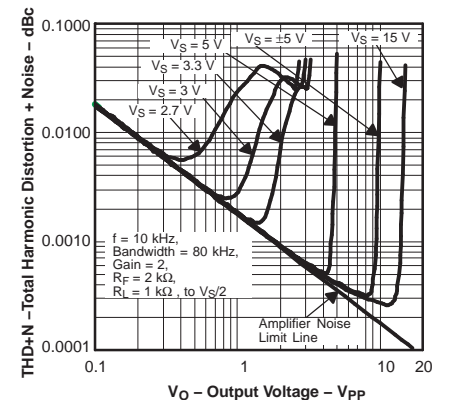

Figure 54.

TYPICAL CHARACTERISTICS (continued)

(f = 100 kHz)  
TOTAL HARMONIC DISTORTION + NOISE  
vs OUTPUT VOLTAGE

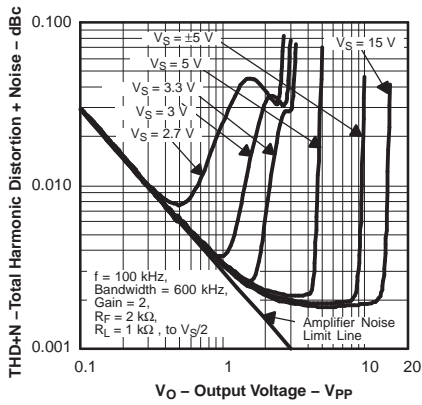

Figure 55.

(VS = 5 V)  
DIFFERENTIAL GAIN vs  
NUMBER OF LOADS

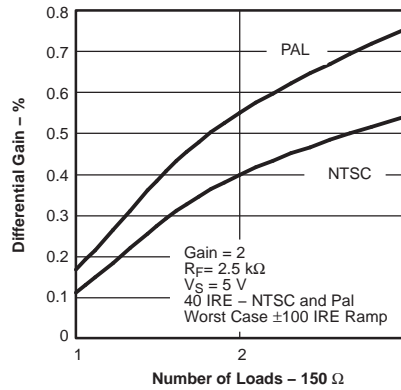

Figure 56.

(VS = 5 V)  
DIFFERENTIAL PHASE vs  
NUMBER OF LOADS

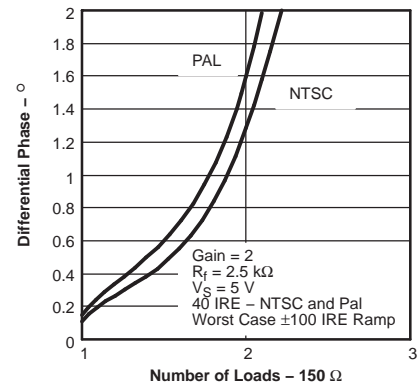

Figure 57.

(VS = ±5 V)  
DIFFERENTIAL GAIN vs  
NUMBER OF LOADS

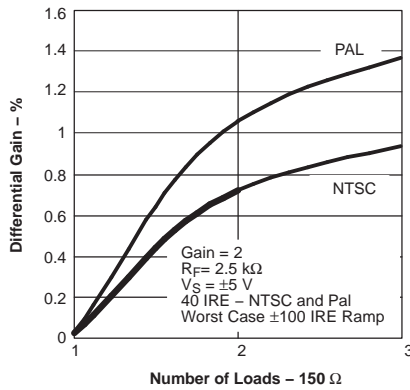

Figure 58.

(VS = ±5 V)  
DIFFERENTIAL PHASE vs  
NUMBER OF LOADS

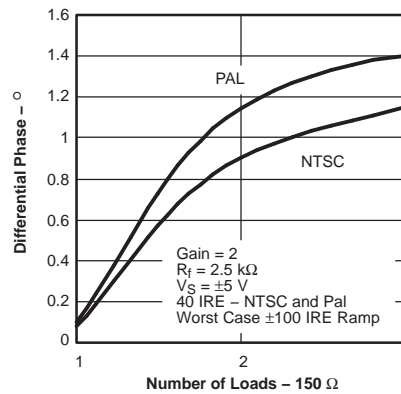

Figure 59.

INPUT OFFSET VOLTAGE  
vs  
TEMPERATURE

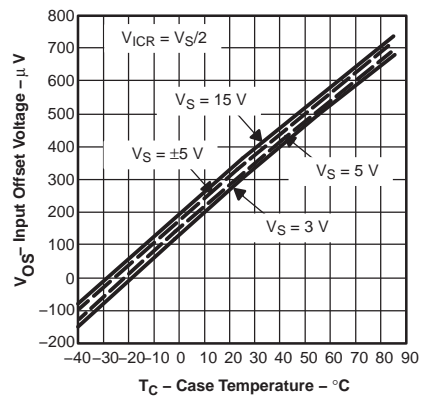

Figure 60.

(VS = 5 V)  
INPUT BIAS AND OFFSET CURRENT  
vs TEMPERATURE

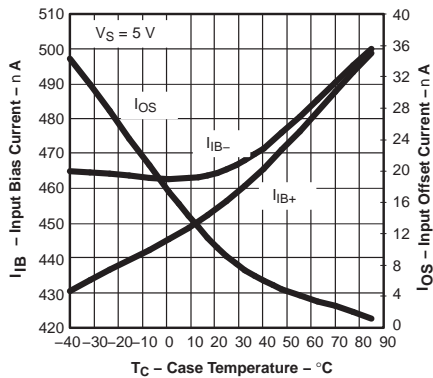

Figure 61.

(VS = 15 V)  
INPUT BIAS AND OFFSET CURRENT  
vs TEMPERATURE

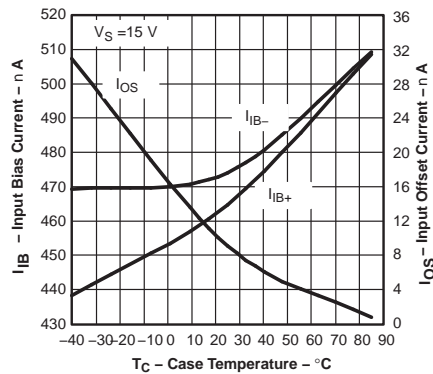

Figure 62.

SMALL-SIGNAL  
TRANSIENT RESPONSE

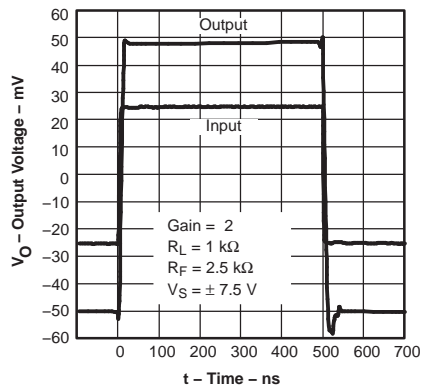

Figure 63.



TYPICAL CHARACTERISTICS (continued)

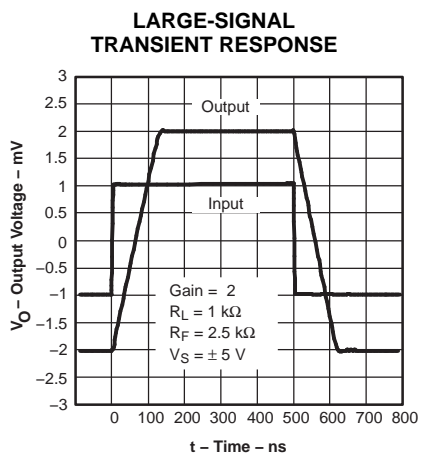

Figure 64.

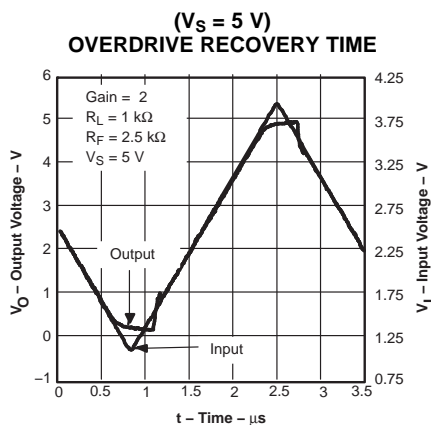

Figure 65.

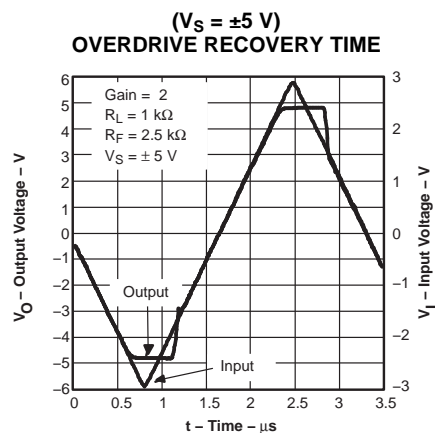

Figure 66.

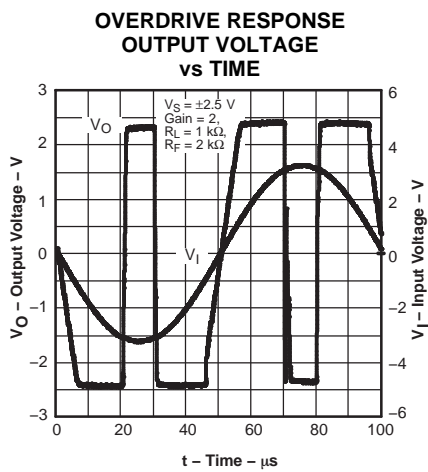

Figure 67.

APPLICATION INFORMATION

HIGH-SPEED OPERATIONAL AMPLIFIERS

The THS4281 is a unity gain stable, rail-to-rail input and output, voltage-feedback operational amplifier designed to operate from a single 2.7-V to 16.5-V power supply.

Applications Section Contents

- Wideband, Noninverting Operation
- Wideband, Inverting Gain Operation
- Video Drive Circuits
- Single-Supply Operation
- Power-Supply Decoupling Techniques and Recommendations
- Active Filtering with the THS4281
- Driving Capacitive Loads
- Board Layout
- Thermal Analysis
- Additional Reference Material
- Mechanical Package Drawings

WIDEBAND, NONINVERTING OPERATION

Figure 68 shows the noninverting gain configuration of 2 V/V used to demonstrate the typical performance curves.

Voltage feedback amplifiers can use a wide range of resistors values to set their gain with minimal impact on frequency response. Larger-valued resistors decrease loading of the feedback network on the output of the amplifier, but may cause peaking and instability. For a gain of +2, feedback resistor values between 1 kΩ and 4 kΩ are recommended for most applications. However, as the gain increases, the use of even higher feedback resistors can be used to conserve power. This is due to the inherent nature of amplifiers becoming more stable as the gain increases, at the expense of bandwidth. Figure 69 and Figure 70 show the THS4281 using feedback resistors of 10 kΩ and 100 kΩ. Be cautioned that using such high values with high-speed amplifiers is not typically recommended, but under certain conditions, such as high gain and good high-speed printed circuit board (PCB) layout practices, such resistances can be used.

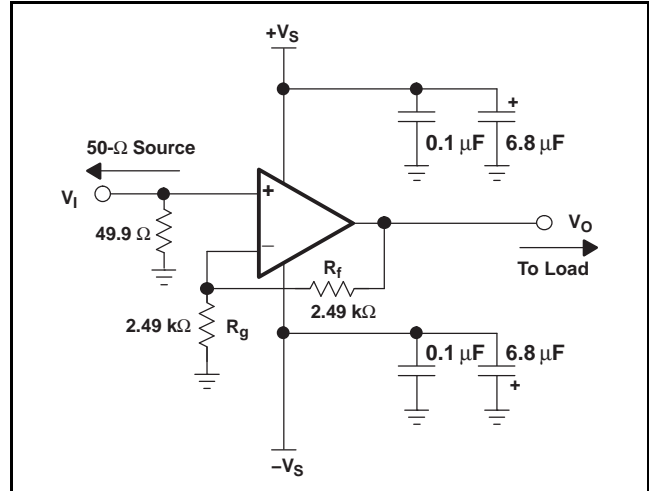

Figure 68. Wideband, Noninverting Gain Configuration

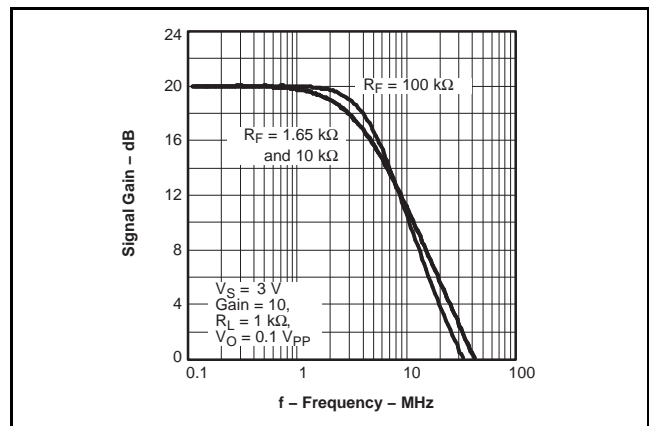

Figure 69. Signal Gain vs Frequency,  $V_S = 3\text{ V}$

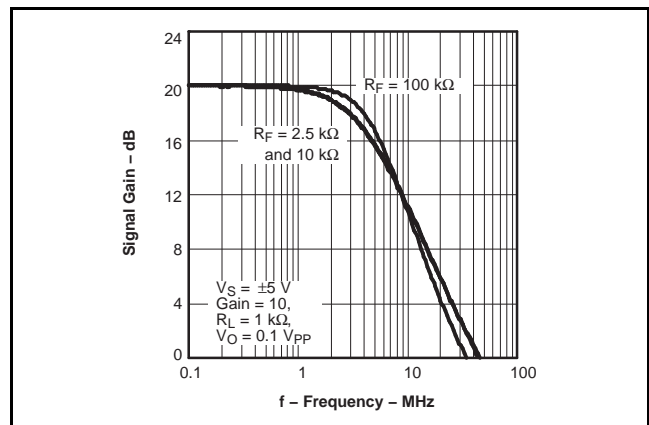

Figure 70. Signal Gain vs Frequency,  $V_S = \pm 5\text{ V}$

### WIDEBAND, INVERTING OPERATION

Figure 71 shows a typical inverting configuration where the input and output impedances and noise gain from Figure 68 are retained with an inverting circuit gain of  $-1$  V/V.

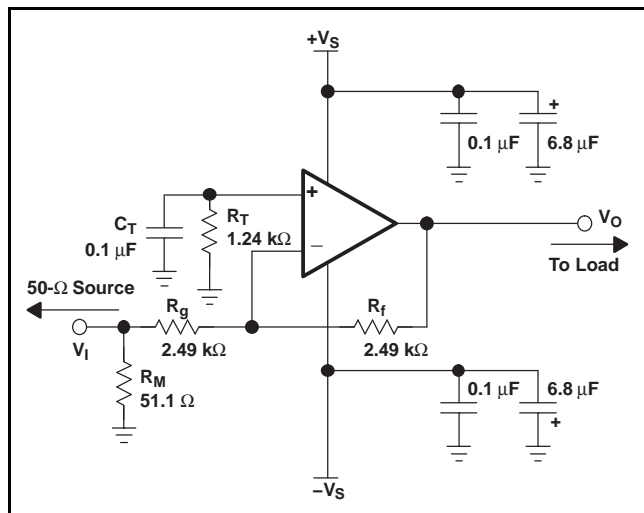

Figure 71. Wideband, Inverting Gain Configuration

In the inverting configuration, some key design considerations must be noted. One is that the gain resistor ( $R_g$ ) becomes part of the signal channel input impedance. If the input impedance matching is desired (which is beneficial whenever the signal is coupled through a cable, twisted pair, long PCB trace, or other transmission line conductors),  $R_g$  may be set equal to the required termination value and  $R_f$  adjusted to give the desired gain. However, care must be taken when dealing with low inverting gains, as the resulting feedback resistor value can present a significant load to the amplifier output. For example, an inverting gain of 2, setting  $R_g$  to 49.9  $\Omega$  for input matching, eliminates the need for  $R_M$  but requires a 100- $\Omega$  feedback resistor. The 100- $\Omega$  feedback resistor, in parallel with the external load, causes excessive loading on the amplifier output. To eliminate this excessive loading, it is preferable to increase both  $R_g$  and  $R_f$  values, as shown in Figure 71, and then achieve the input matching impedance with a third resistor ( $R_M$ ) to ground. The total input impedance is the parallel combination of  $R_g$  and  $R_M$ .

Another consideration in inverting amplifier design is setting the bias current cancellation resistor ( $R_T$ ) on the noninverting input. If the resistance is set equal to the total dc resistance presented to the device at the inverting terminal, the output dc error (due to the input bias currents) is reduced to the input offset current multiplied by  $R_T$ . In Figure 71, the dc source impedance presented at the inverting terminal is  $2.49 \text{ k}\Omega \parallel (2.49 \text{ k}\Omega + 25.3 \text{ }\Omega) \approx 1.24 \text{ k}\Omega$ . To reduce the additional high-frequency noise introduced by the resistor at the noninverting input,  $R_T$  is bypassed with a 0.1- $\mu\text{F}$  capacitor to ground ( $C_T$ ).

### SINGLE-SUPPLY OPERATION

The THS4281 is designed to operate from a single 2.7-V to 16.5-V power supply. When operating from a single power supply, care must be taken to ensure the input signal and amplifier are biased appropriately to allow for the maximum output voltage swing and not violate  $V_{ICR}$ . The circuits shown in Figure 72 shows inverting and noninverting amplifiers configured for single-supply operation.

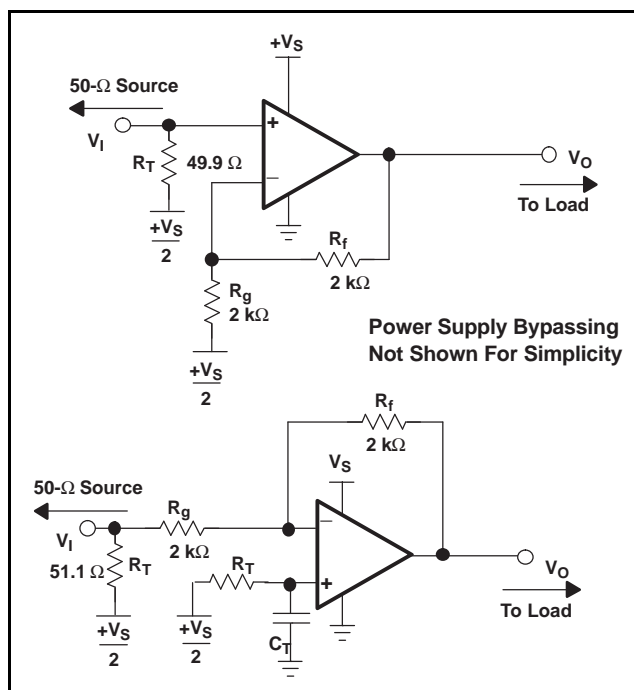

Figure 72. DC-Coupled Single Supply Operation

APPLICATION CIRCUITS

Active Filtering with the THS4281

High-performance active filtering with the THS4281 is achievable due to the amplifier's good slew rate, wide bandwidth, and voltage-feedback architecture. Several options are available for high-pass, low-pass, bandpass, and bandstop filters of varying orders. Filters can be quite complex and time consuming to design. Several books and application reports are available to help design active filters. But, to help simplify the process and minimize the chance of miscalculations, Texas Instruments has developed a filter design program called FilterPro™. FilterPro is available for download at no cost from TI's web site ([www.ti.com](http://www.ti.com)).

The two most common low-pass filter circuits used are the Sallen-Key filter and the Multiple Feedback (MFB) – aka Rauch filter. FilterPro was used to determine a 2-pole Butterworth response filter with a corner (–3-dB) frequency of 100 kHz, which is shown in Figure 73 and Figure 74. One of the advantages of the MFB filter, a much better high-frequency rejection, is clearly shown in Figure 75. This is due to the inherent R-C filter to ground being the first elements in the design of the MFB filter. The Sallen-Key design also has an R-C filter, but the capacitor connects directly to the output. At very high frequencies, where the amplifier's access loop gain is decreasing, the ability of the amplifier to reject high frequencies is severely reduced and allows the high-frequency signals to pass through the system. One other advantage of the MFB filter is the reduced sensitivity in component variation. This is important when using real-world components where capacitors can easily have ±10% variations.

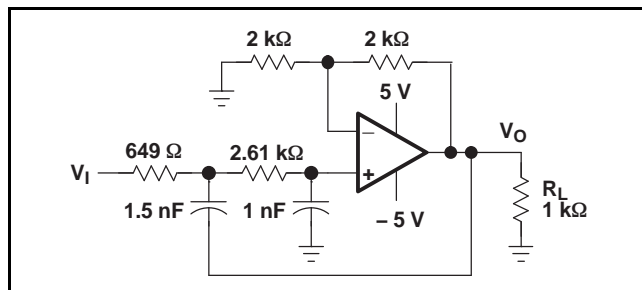

Figure 73. Second-Order Sallen-Key 100-kHz Butterworth Filter, Gain = 2 V/V

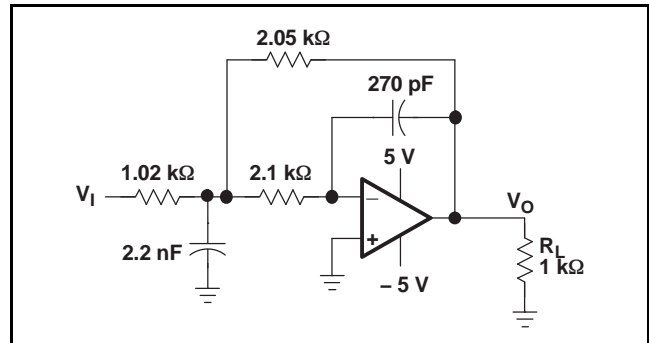

Figure 74. Second-Order MFB 100-kHz Butterworth Filter, Gain = 2 V/V

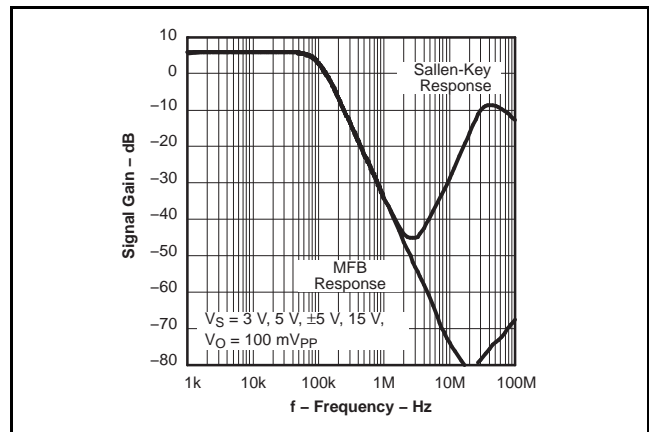

Figure 75. Second-Order 100-kHz Active Filter Response

Driving Capacitive Loads

One of the most demanding, and yet common, load conditions for an op amp is capacitive loading. Often, the capacitive load is the input of an A/D converter, including additional external capacitance, which may be recommended to improve A/D linearity. A high-speed, high open-loop gain amplifier like the THS4281 can be susceptible to instability and peaking when a capacitive load is placed directly on the output. When the amplifier open-loop output resistance is considered, this capacitive load introduces an additional pole in the feedback path that decreases the phase margin. When the primary considerations are frequency response flatness, pulse response fidelity, or distortion, a simple and effective solution is to isolate the capacitive load from the feedback loop by inserting a small series isolation resistor (for example,  $R_{(ISO)} = 100 \Omega$  for  $C_{LOAD} = 10 \text{ pF}$  to  $R_{(ISO)} = 10 \Omega$  for  $C_{LOAD} = 1000 \text{ pF}$ ) between the amplifier output and the capacitive load.

## Power-Supply Decoupling Techniques and Recommendations

Power-supply decoupling is a critical aspect of any high-performance amplifier design. Careful decoupling provides higher quality ac performance. The following guidelines ensure the highest level of performance.

1. Place decoupling capacitors as close to the power-supply inputs as possible, with the goal of minimizing the inductance.
2. Placement priority should put the smallest valued capacitors closest to the device.
3. Use of solid power and ground planes is recommended to reduce the inductance along power-supply return current paths (with the exception of the areas underneath the input and output pins as noted below).
4. A bulk decoupling capacitor is recommended (6.8  $\mu\text{F}$  to 22  $\mu\text{F}$ ) within 1 inch, and a ceramic (0.1  $\mu\text{F}$ ) within 0.1 inch of the power input pins.

### NOTE

The bulk capacitor may be shared by other op amps.

## BOARD LAYOUT

Achieving optimum performance with a high-frequency amplifier like the THS4281 requires careful attention to board layout parasitics and external component types. See the EVM layout figures ([Figure 78](#) to [Figure 81](#)) in the [Design Tools](#) section.

Recommendations that optimize performance include:

1. **Minimize parasitic capacitance to any ac ground for all of the signal I/O pins.** Parasitic capacitance on the output and inverting input pins can cause instability and on the noninverting input, it can react with the source impedance to

cause unintentional band limiting. To reduce unwanted capacitance, a window around the signal I/O pins should be opened in all of the ground and power planes around those pins. Otherwise, ground and power planes should be unbroken elsewhere on the board.

2. **Minimize the distance (< 0.1 inch) from the power-supply pins to high-frequency, 0.1- $\mu\text{F}$  decoupling capacitors.** Avoid narrow power and ground traces to minimize inductance. The power-supply connections should always be decoupled as described above.
3. **Careful selection and placement of external components preserves the high-frequency performance of the THS4281.** Resistors should be a low reactance type. Surface-mount resistors work best and allow a tighter overall layout. Metal-film, axial-lead resistors can also provide good high-frequency performance. Again, keep the leads and PCB trace length as short as possible. Never use wire-wound type resistors in a high-frequency application. Because the output pin and inverting input pin are the most sensitive to parasitic capacitance, always position the feedback and series output resistor, if any, as close as possible to the output pin. Other network components, such as noninverting input termination resistors, should also be placed close to the package. Excessively high resistor values can create significant phase lag that can degrade performance. Keep resistor values as low as possible, consistent with load-driving considerations. It is suggested that a good starting point for design is to set the  $R_f$  to 2 k $\Omega$  for low-gain, noninverting applications. Doing this automatically keeps the resistor noise terms reasonable and minimizes the effect of parasitic capacitance.

4. **Connections to other wideband devices on the board should be made with short direct traces or through onboard transmission lines.**

For short connections, consider the trace and the input to the next device as a lumped capacitive load. Relatively wide traces (50 mils to 100 mils) should be used, preferably with ground and power planes opened up around them. Low parasitic capacitive loads (< 4 pF) may not need an  $R_{(ISO)}$ , because the THS4281 is nominally compensated to operate at unity gain (+1 V/V) with a 2-pF capacitive load. Higher capacitive loads without an  $R_{(ISO)}$  are allowed as the signal gain increases. If a long trace is required, and the 6-dB signal loss intrinsic to a doubly terminated transmission line is acceptable, implement a matched impedance transmission line using microstrip or stripline techniques (consult an ECL design handbook for microstrip and stripline layout techniques). A matching series resistor into the trace from the output of the THS4281 is used as well as a terminating shunt resistor at the input of the destination device. Remember also that the terminating impedance is the parallel combination of the shunt resistor and the input impedance of the destination device: this total effective impedance should be set to match the trace impedance. If the 6-dB attenuation of a doubly-terminated transmission line is unacceptable, a long trace can be series-terminated at the source end only. Treat the trace as a capacitive load in this case, and use a series resistor ( $R_{(ISO)} = 10\ \Omega$  to  $100\ \Omega$ , as noted [above](#)) to isolate the capacitive load. If the input impedance of the destination device is low, there is signal attenuation due to the voltage divider formed by  $R_{(ISO)}$  into the terminating impedance. A 50- $\Omega$  environment is normally not necessary onboard, and in fact a higher impedance environment improves distortion as shown in the distortion versus load plots.

5. **Socketing a high-speed part like the THS4281 is not recommended.** The additional lead length and pin-to-pin capacitance introduced by the socket can create a troublesome parasitic network which can make it almost impossible to achieve a smooth, stable frequency response. Best results are obtained by soldering the THS4281 onto the board.

## THERMAL ANALYSIS

The THS4281 does not incorporate automatic thermal shutoff protection, so the designer must take care to ensure that the design does not violate the absolute maximum junction temperature of the device. Failure may result if the absolute maximum junction temperature of +150° C is exceeded. For long-term dependability, the junction temperature should not exceed +125°C.

The thermal characteristics of the device are dictated by the package and the PCB. Maximum power dissipation for a given package can be calculated using the following formula.

$$P_{Dmax} = \frac{T_{max} - T_A}{\theta_{JA}}$$

where:

$P_{Dmax}$  is the maximum power dissipation in the amplifier (W).

$T_{max}$  is the absolute maximum junction temperature (°C).

$T_A$  is the ambient temperature (°C).

$\theta_{JA} = \theta_{JC} + \theta_{CA}$

$\theta_{JC}$  is the thermal coefficient from the silicon junctions to the case (°C/W).

$\theta_{CA}$  is the thermal coefficient from the case to ambient air (°C/W).

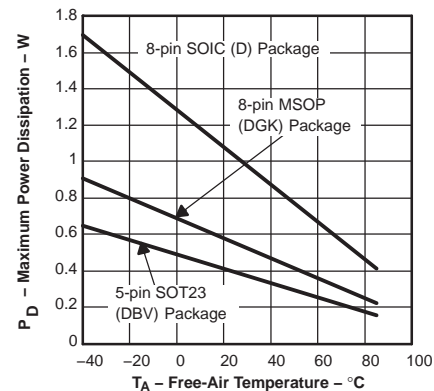

$\theta_{JA} = 97.5^\circ\text{C/W}$  for 8-Pin SOIC (D)  
 $\theta_{JA} = 180.8^\circ\text{C/W}$  for 8-Pin MSOP (DGK)  
 $\theta_{JA} = 255.4^\circ\text{C/W}$  for 5-Pin SOT-23 (DBV)  
 $T_J = 125^\circ\text{C}$ , No Airflow

**Figure 76. Maximum Power Dissipation vs Ambient Temperature**

When determining whether or not the device satisfies the maximum power dissipation requirement, it is important to consider not only quiescent power dissipation, but also dynamic power dissipation. Often maximum power dissipation is difficult to quantify because the signal pattern is inconsistent, but an estimate of the RMS value can provide a reasonable analysis.

## DESIGN TOOLS

### Evaluation Fixtures and Application Support Information

Texas Instruments is committed to providing its customers with the highest quality of applications support. To support this goal, an evaluation board has been developed for the THS4281 operational amplifier. The evaluation board is available and easy to use allowing for straight-forward evaluation of the device. These evaluation board can be obtained by ordering through the [Texas Instruments web site](#), or through your local Texas Instruments Sales Representative. A schematic for the evaluation board is shown in [Figure 77](#) with their default component values. Unpopulated footprints are shown to provide insight into design flexibility.

Computer simulation of circuit performance using SPICE is often useful when analyzing the performance of analog circuits and systems. This is particularly true for video and RF amplifier circuits where parasitic capacitance and inductance can have a major effect on circuit performance. A SPICE model for the THS4281 device is available through either the Texas Instruments web site or as one model on a disk from the Texas Instruments Product Information Center (1-800-548-6132). The PIC is also available for design assistance and detailed product information at this number. These models do a good job of predicting small-signal ac and transient performance under a wide variety of operating conditions. They are not intended to model the distortion characteristics of the amplifier, nor do they attempt to distinguish between the package types in their small-signal ac performance. Detailed information about what is and is not modeled is contained in the model file itself.

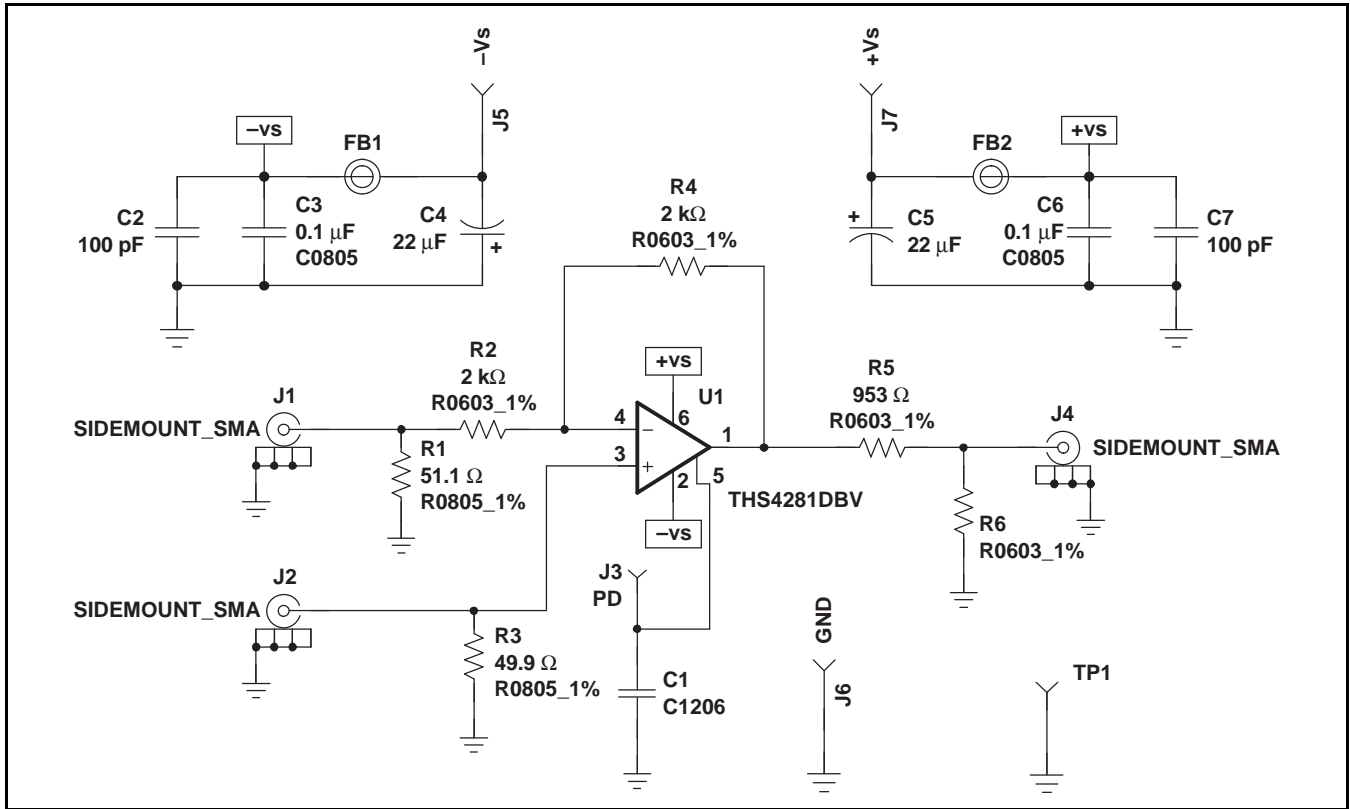
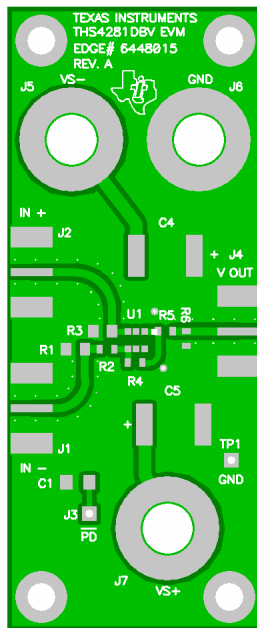
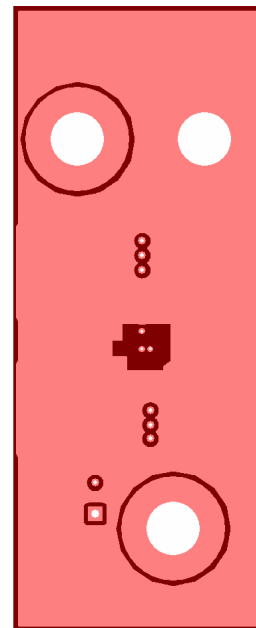

Figure 77. THS4281EVM Schematic



TOP

Figure 78. THS4281EVM Layout (Top Layer and Silkscreen Layer)



Layer 2 – GND

Figure 79. THS4281EVM Board Layout



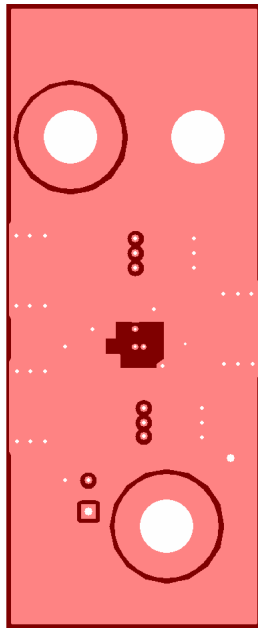

Layer 3 – GND

**Figure 80.**  
THS4281EVM Board Layout

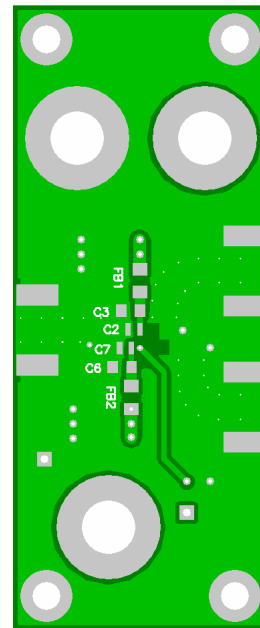

BOTTOM

**Figure 81.**  
THS4281EVM Board Layout

## BILL OF MATERIALS

### THS4281DBV EVM

ITEM	DESCRIPTION	SMD SIZE	REFERENCE DESIGNATOR	PCB QTY.	MANUFACTURER'S PART NUMBER <sup>(1)</sup>	DISTRIBUTOR'S PART NUMBER
1	Bead, Ferrite, 3A, 80 Ω	1206	FB1, FB2	2	(STEWART) HI1206N800R-00	(DIGI-KEY) 240-1010-1-ND
2	OPEN	1206	C1	1		
3	Cap, 22 μF, tanatum, 25 V, 10%	D	C4, C5	2	(AVX) TAJD226K025R	(GARRETT) TAJD226K025R
4	Cap, 0.1 μF, ceramic, X7R, 50V	0805	C3, C6	2	(AVX) 08055C104KAT2A	(GARRETT) 08055C104KAT2A
5	Cap, 100 pF, ceramic, 5%, 150V	AQ12	C2, C7	2	(AVX) AQ12EM101JAJME	(TTI) AQ12EM101JAJME
6	OPEN	0603	R6	1		
7	Resistor, 2 KΩ, 1/10W, 1%	0603	R2, R4	2	(PHYCOMP) 9C06031A2001FKHFT	(GARRETT) 9C06031A2001FKHFT
8	Resistor, 953 Ω, 1/10W, 1%	0603	R5	1	(PHYCOMP) 9C06031A9530FKRFT	(GARRETT) 9C06031A9530FKRFT
9	Resistor, 51.1 Ω, 1/8W, 1%	0805	R1	1	(PHYCOMP) 9C08052A51R1FKHFT	(GARRETT) 9C08052A51R1FKHFT
10	Resistor, 49.9 Ω, 1/8W, 1%	0805	R3	1	(PHYCOMP) 9C08052A49R9FKHFT	(GARRETT) 9C08052A49R9FKHFT
11	Jack, banana receptance, 0.25" diameter hole		J5, J6, J7	3	(HH SMITH) 101	(NEWARK) 35F865
12	OPEN		J3	1		
13	Test point, black		TP1	1	(KEYSTONE) 5001	(DIGI-KEY) 5001K-ND
14	Connector, edge, SMA PCB JACK		J1, J2, J4	3	(JOHNSON) 142-0701-801	(NEWARK) 90F2624
15	Standoff, 4-40 HEX, 0.625" length			4	(KEYSTONE) 1804	(NEWARK) 89F1934
16	Screw, PHILLIPS, 4-40, 0.250"			4	SHR-0440-016-SN	
17	IC, THS4281		U1	1	(TI) THS4281DBV	
18	Board, printed circuit			1	(TI) EDGE # 6448015 Rev.A	

(1) The manufacturer's part numbers are used for test purposes only.

### ADDITIONAL REFERENCE MATERIALS

- *PowerPAD Made Easy*, application brief ([SLMA004](#))
- *PowerPAD Thermally Enhanced Package*, technical brief ([SLMA002](#))
- *Active Low-Pass Filter Design*, application report ([SLOA049](#))
- *FilterPro MFB and Sallen-Key Low-Pass Filter Design Program*, application report ([SBFA001](#))

## REVISION HISTORY

NOTE: Page numbers for previous revisions may differ from page numbers in the current version.

<b>Changes from Original (April, 2004) to Revision A</b>	<b>Page</b>
• Updated document format to current standards .....	1
• Deleted <i>Lead temperature</i> specification from Absolute Maximum Ratings table .....	2
• Revised <i>Driving Capacitive Loads</i> section .....	20
• Changed <i>Board Layout</i> section; revised statements in fourth recommendation about how to make connections to other wideband devices on the board .....	22

**PACKAGING INFORMATION**

Orderable Device	Status (1)	Package Type	Package Drawing	Pins	Package Qty	Eco Plan (2)	Lead/Ball Finish	MSL Peak Temp (3)	Op Temp (°C)	Top-Side Markings (4)	Samples
THS4281D	ACTIVE	SOIC	D	8	75	Green (RoHS & no Sb/Br)	CU NIPDAU	Level-1-260C-UNLIM	-40 to 85	4281	<a href="#">Samples</a>
THS4281DBVR	ACTIVE	SOT-23	DBV	5	3000	Green (RoHS & no Sb/Br)	CU NIPDAU	Level-1-260C-UNLIM	-40 to 85	AON	<a href="#">Samples</a>
THS4281DBVRG4	ACTIVE	SOT-23	DBV	5	3000	Green (RoHS & no Sb/Br)	CU NIPDAU	Level-1-260C-UNLIM	-40 to 85	AON	<a href="#">Samples</a>
THS4281DBVT	ACTIVE	SOT-23	DBV	5	250	Green (RoHS & no Sb/Br)	CU NIPDAU	Level-1-260C-UNLIM	-40 to 85	AON	<a href="#">Samples</a>
THS4281DBVTG4	ACTIVE	SOT-23	DBV	5	250	Green (RoHS & no Sb/Br)	CU NIPDAU	Level-1-260C-UNLIM	-40 to 85	AON	<a href="#">Samples</a>
THS4281DG4	ACTIVE	SOIC	D	8	75	Green (RoHS & no Sb/Br)	CU NIPDAU	Level-1-260C-UNLIM	-40 to 85	4281	<a href="#">Samples</a>
THS4281DGK	ACTIVE	VSSOP	DGK	8	80	Green (RoHS & no Sb/Br)	CU NIPDAU	Level-1-260C-UNLIM	-40 to 85	AOO	<a href="#">Samples</a>
THS4281DGKG4	ACTIVE	VSSOP	DGK	8	80	Green (RoHS & no Sb/Br)	CU NIPDAU	Level-1-260C-UNLIM	-40 to 85	AOO	<a href="#">Samples</a>
THS4281DGKR	ACTIVE	VSSOP	DGK	8	2500	Green (RoHS & no Sb/Br)	CU NIPDAU	Level-1-260C-UNLIM	-40 to 85	AOO	<a href="#">Samples</a>
THS4281DGKRG4	ACTIVE	VSSOP	DGK	8	2500	Green (RoHS & no Sb/Br)	CU NIPDAU	Level-1-260C-UNLIM	-40 to 85	AOO	<a href="#">Samples</a>
THS4281DR	ACTIVE	SOIC	D	8	2500	Green (RoHS & no Sb/Br)	CU NIPDAU	Level-1-260C-UNLIM	-40 to 85	4281	<a href="#">Samples</a>
THS4281DRG4	ACTIVE	SOIC	D	8	2500	Green (RoHS & no Sb/Br)	CU NIPDAU	Level-1-260C-UNLIM	-40 to 85	4281	<a href="#">Samples</a>

(1) The marketing status values are defined as follows:

**ACTIVE:** Product device recommended for new designs.

**LIFEBUY:** TI has announced that the device will be discontinued, and a lifetime-buy period is in effect.

**NRND:** Not recommended for new designs. Device is in production to support existing customers, but TI does not recommend using this part in a new design.

**PREVIEW:** Device has been announced but is not in production. Samples may or may not be available.

**OBSOLETE:** TI has discontinued the production of the device.

(2) Eco Plan - The planned eco-friendly classification: Pb-Free (RoHS), Pb-Free (RoHS Exempt), or Green (RoHS & no Sb/Br) - please check <http://www.ti.com/productcontent> for the latest availability information and additional product content details.

**TBD:** The Pb-Free/Green conversion plan has not been defined.

---

**Pb-Free (RoHS):** TI's terms "Lead-Free" or "Pb-Free" mean semiconductor products that are compatible with the current RoHS requirements for all 6 substances, including the requirement that lead not exceed 0.1% by weight in homogeneous materials. Where designed to be soldered at high temperatures, TI Pb-Free products are suitable for use in specified lead-free processes.

**Pb-Free (RoHS Exempt):** This component has a RoHS exemption for either 1) lead-based flip-chip solder bumps used between the die and package, or 2) lead-based die adhesive used between the die and leadframe. The component is otherwise considered Pb-Free (RoHS compatible) as defined above.

**Green (RoHS & no Sb/Br):** TI defines "Green" to mean Pb-Free (RoHS compatible), and free of Bromine (Br) and Antimony (Sb) based flame retardants (Br or Sb do not exceed 0.1% by weight in homogeneous material)

<sup>(3)</sup> MSL, Peak Temp. -- The Moisture Sensitivity Level rating according to the JEDEC industry standard classifications, and peak solder temperature.

<sup>(4)</sup> Multiple Top-Side Markings will be inside parentheses. Only one Top-Side Marking contained in parentheses and separated by a "~" will appear on a device. If a line is indented then it is a continuation of the previous line and the two combined represent the entire Top-Side Marking for that device.

**Important Information and Disclaimer:** The information provided on this page represents TI's knowledge and belief as of the date that it is provided. TI bases its knowledge and belief on information provided by third parties, and makes no representation or warranty as to the accuracy of such information. Efforts are underway to better integrate information from third parties. TI has taken and continues to take reasonable steps to provide representative and accurate information but may not have conducted destructive testing or chemical analysis on incoming materials and chemicals. TI and TI suppliers consider certain information to be proprietary, and thus CAS numbers and other limited information may not be available for release.

In no event shall TI's liability arising out of such information exceed the total purchase price of the TI part(s) at issue in this document sold by TI to Customer on an annual basis.

## TAPE AND REEL INFORMATION



### QUADRANT ASSIGNMENTS FOR PIN 1 ORIENTATION IN TAPE



\*All dimensions are nominal

Device	Package Type	Package Drawing	Pins	SPQ	Reel Diameter (mm)	Reel Width W1 (mm)	A0 (mm)	B0 (mm)	K0 (mm)	P1 (mm)	W (mm)	Pin1 Quadrant
THS4281DBVR	SOT-23	DBV	5	3000	180.0	9.0	3.15	3.2	1.4	4.0	8.0	Q3
THS4281DBVT	SOT-23	DBV	5	250	180.0	9.0	3.15	3.2	1.4	4.0	8.0	Q3
THS4281DGKR	VSSOP	DGK	8	2500	330.0	12.4	5.3	3.4	1.4	8.0	12.0	Q1
THS4281DR	SOIC	D	8	2500	330.0	12.4	6.4	5.2	2.1	8.0	12.0	Q1

**TAPE AND REEL BOX DIMENSIONS**

\*All dimensions are nominal

Device	Package Type	Package Drawing	Pins	SPQ	Length (mm)	Width (mm)	Height (mm)
THS4281DBVR	SOT-23	DBV	5	3000	182.0	182.0	20.0
THS4281DBVT	SOT-23	DBV	5	250	182.0	182.0	20.0
THS4281DGKR	VSSOP	DGK	8	2500	358.0	335.0	35.0
THS4281DR	SOIC	D	8	2500	367.0	367.0	35.0

DBV (R-PDSO-G5)

PLASTIC SMALL-OUTLINE PACKAGE

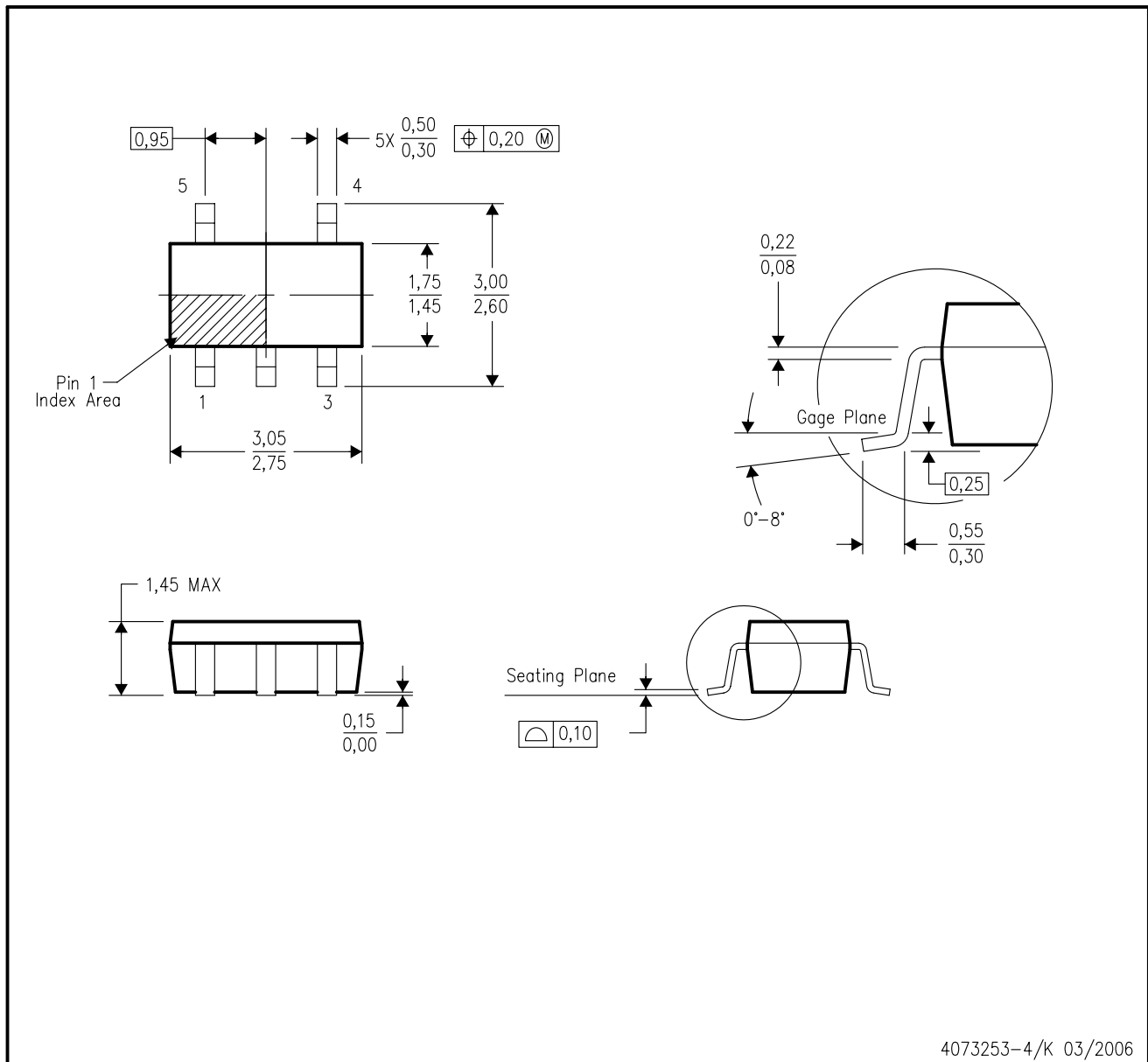

- NOTES:
- A. All linear dimensions are in millimeters.
  - B. This drawing is subject to change without notice.
  - C. Body dimensions do not include mold flash or protrusion. Mold flash and protrusion shall not exceed 0.15 per side.
  - D. Falls within JEDEC MO-178 Variation AA.



DBV (R-PDSO-G5)

PLASTIC SMALL OUTLINE

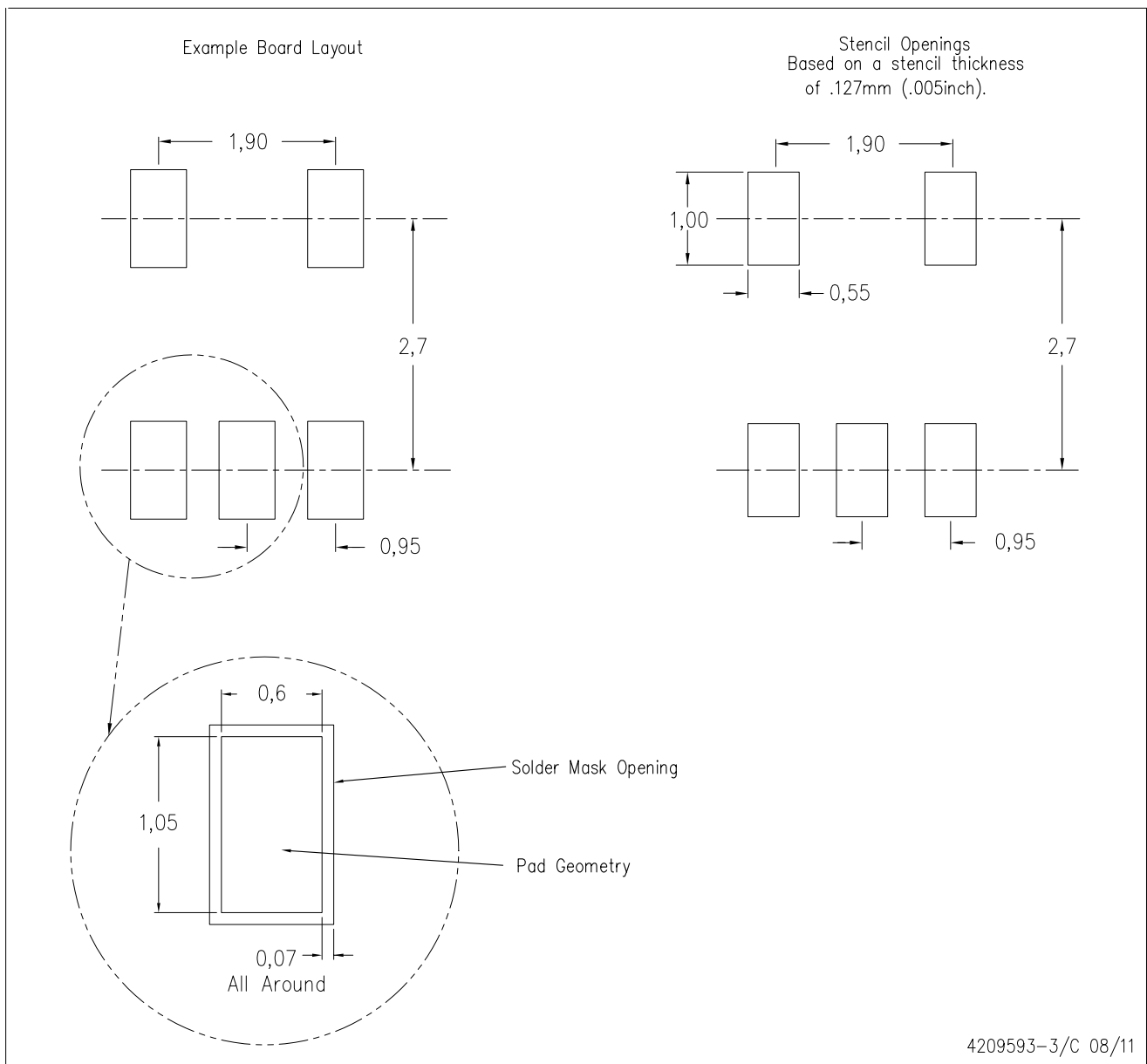

- NOTES:
- A. All linear dimensions are in millimeters.
  - B. This drawing is subject to change without notice.
  - C. Customers should place a note on the circuit board fabrication drawing not to alter the center solder mask defined pad.
  - D. Publication IPC-7351 is recommended for alternate designs.
  - E. Laser cutting apertures with trapezoidal walls and also rounding corners will offer better paste release. Customers should contact their board assembly site for stencil design recommendations. Example stencil design based on a 50% volumetric metal load solder paste. Refer to IPC-7525 for other stencil recommendations.

DGK (S-PDSO-G8)

PLASTIC SMALL-OUTLINE PACKAGE

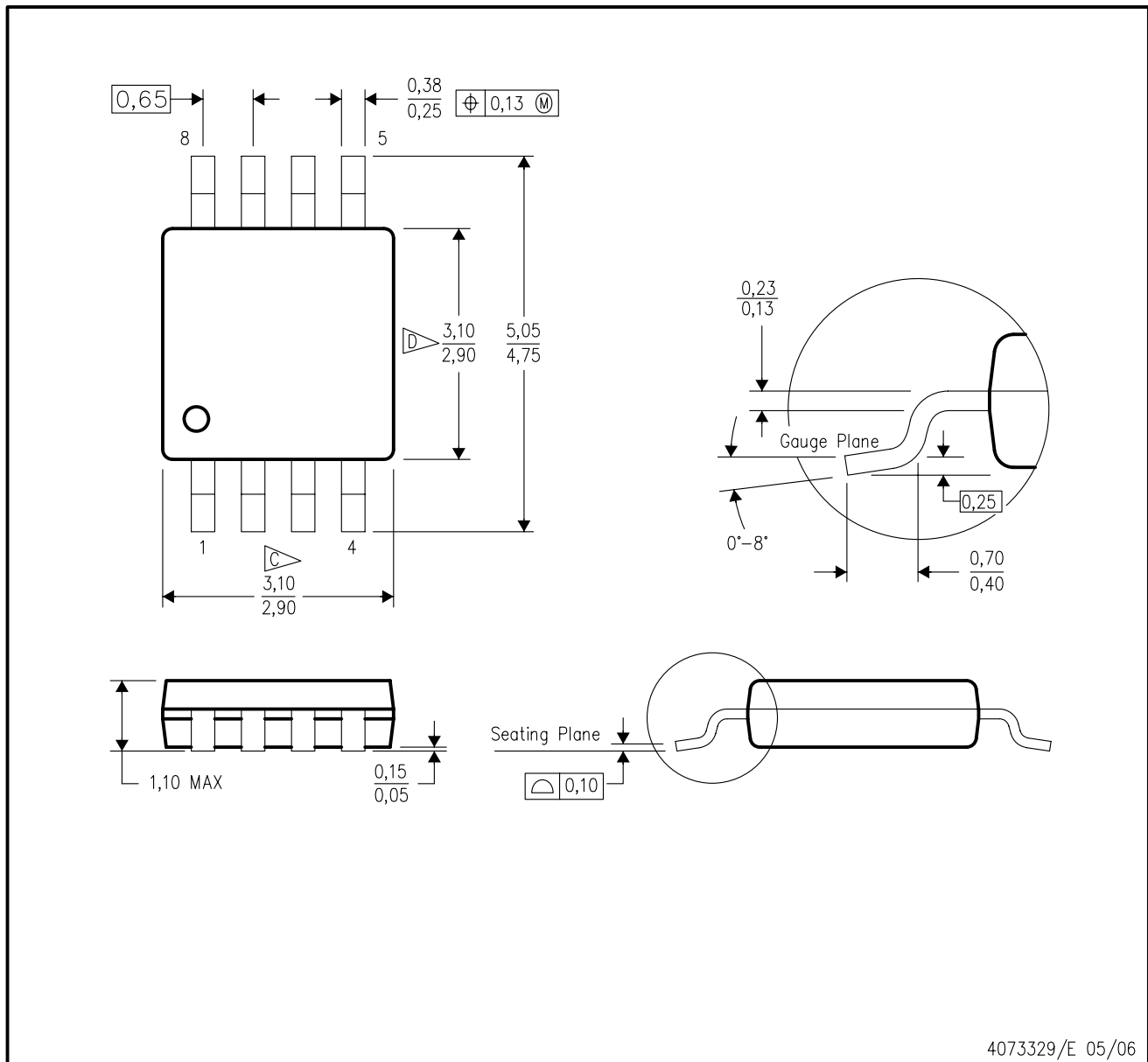

- NOTES:
- A. All linear dimensions are in millimeters.
  - B. This drawing is subject to change without notice.
  - C. Body length does not include mold flash, protrusions, or gate burrs. Mold flash, protrusions, or gate burrs shall not exceed 0.15 per end.
  - D. Body width does not include interlead flash. Interlead flash shall not exceed 0.50 per side.
  - E. Falls within JEDEC MO-187 variation AA, except interlead flash.

D (R-PDSO-G8)

PLASTIC SMALL OUTLINE

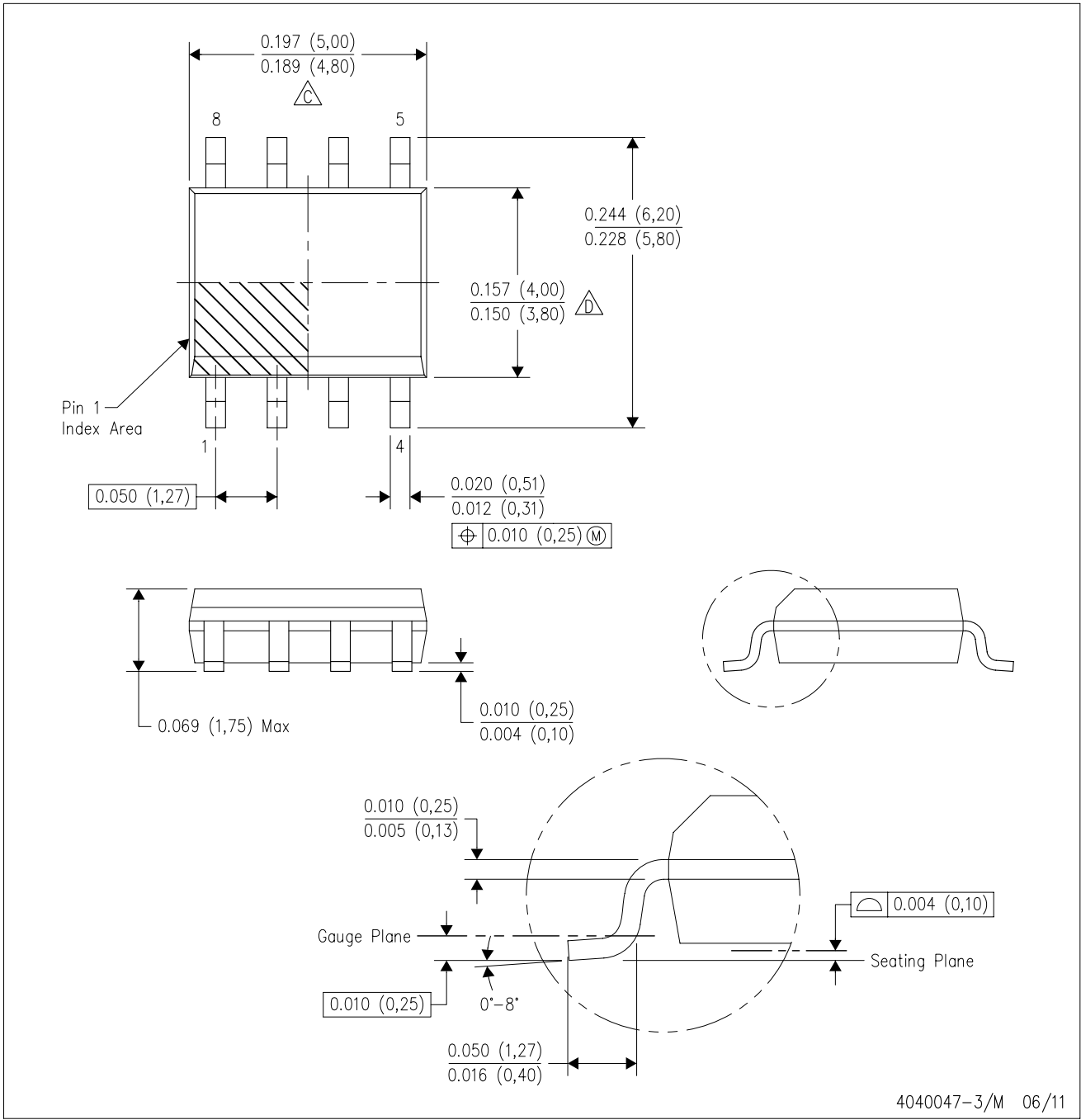

4040047-3/M 06/11

D (R-PDSO-G8)

PLASTIC SMALL OUTLINE

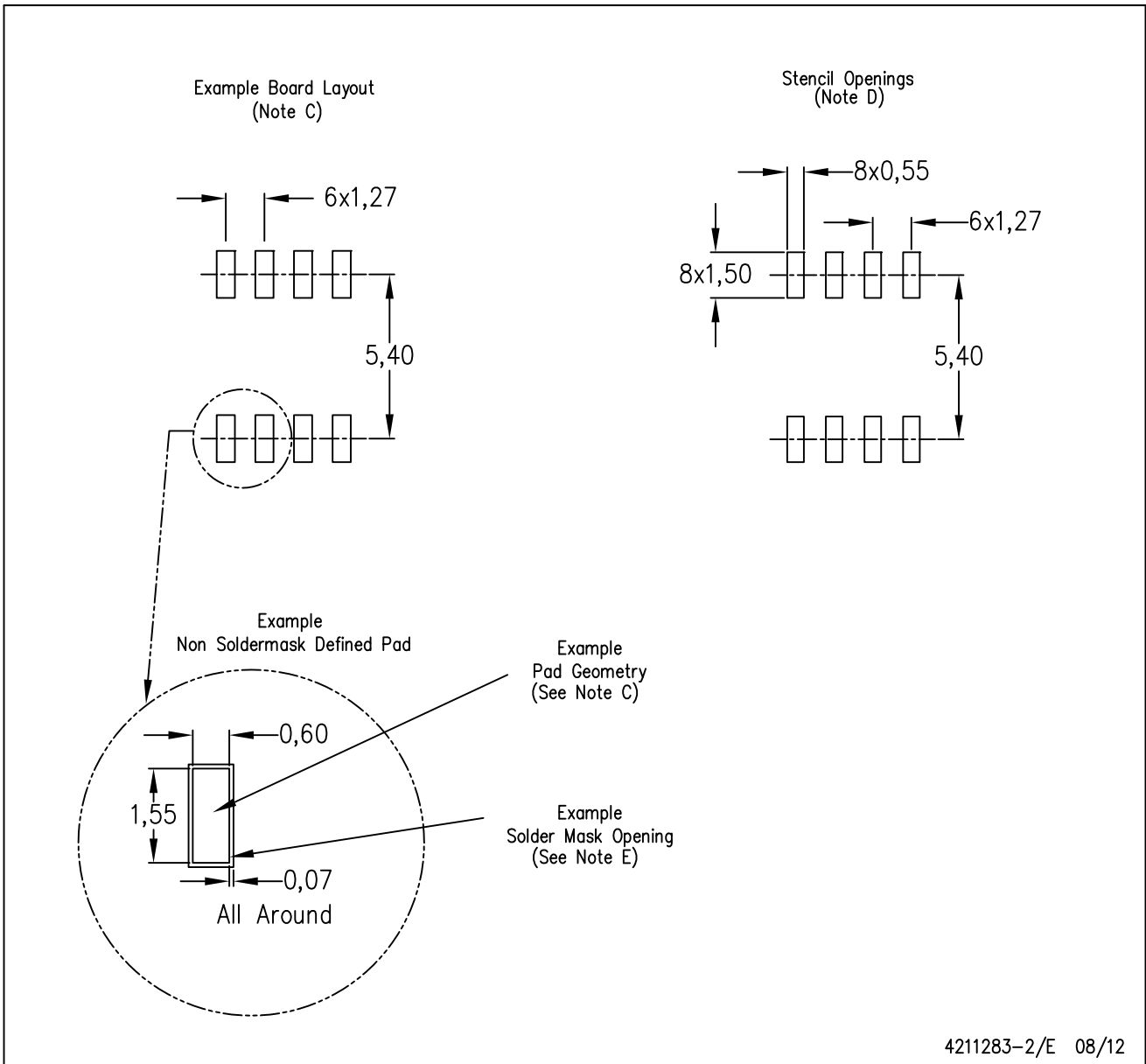

4211283-2/E 08/12

- NOTES:
- A. All linear dimensions are in millimeters.
  - B. This drawing is subject to change without notice.
  - C. Publication IPC-7351 is recommended for alternate designs.
  - D. Laser cutting apertures with trapezoidal walls and also rounding corners will offer better paste release. Customers should contact their board assembly site for stencil design recommendations. Refer to IPC-7525 for other stencil recommendations.
  - E. Customers should contact their board fabrication site for solder mask tolerances between and around signal pads.

## IMPORTANT NOTICE

Texas Instruments Incorporated and its subsidiaries (TI) reserve the right to make corrections, enhancements, improvements and other changes to its semiconductor products and services per JESD46, latest issue, and to discontinue any product or service per JESD48, latest issue. Buyers should obtain the latest relevant information before placing orders and should verify that such information is current and complete. All semiconductor products (also referred to herein as "components") are sold subject to TI's terms and conditions of sale supplied at the time of order acknowledgment.

TI warrants performance of its components to the specifications applicable at the time of sale, in accordance with the warranty in TI's terms and conditions of sale of semiconductor products. Testing and other quality control techniques are used to the extent TI deems necessary to support this warranty. Except where mandated by applicable law, testing of all parameters of each component is not necessarily performed.

TI assumes no liability for applications assistance or the design of Buyers' products. Buyers are responsible for their products and applications using TI components. To minimize the risks associated with Buyers' products and applications, Buyers should provide adequate design and operating safeguards.

TI does not warrant or represent that any license, either express or implied, is granted under any patent right, copyright, mask work right, or other intellectual property right relating to any combination, machine, or process in which TI components or services are used. Information published by TI regarding third-party products or services does not constitute a license to use such products or services or a warranty or endorsement thereof. Use of such information may require a license from a third party under the patents or other intellectual property of the third party, or a license from TI under the patents or other intellectual property of TI.

Reproduction of significant portions of TI information in TI data books or data sheets is permissible only if reproduction is without alteration and is accompanied by all associated warranties, conditions, limitations, and notices. TI is not responsible or liable for such altered documentation. Information of third parties may be subject to additional restrictions.

Resale of TI components or services with statements different from or beyond the parameters stated by TI for that component or service voids all express and any implied warranties for the associated TI component or service and is an unfair and deceptive business practice. TI is not responsible or liable for any such statements.

Buyer acknowledges and agrees that it is solely responsible for compliance with all legal, regulatory and safety-related requirements concerning its products, and any use of TI components in its applications, notwithstanding any applications-related information or support that may be provided by TI. Buyer represents and agrees that it has all the necessary expertise to create and implement safeguards which anticipate dangerous consequences of failures, monitor failures and their consequences, lessen the likelihood of failures that might cause harm and take appropriate remedial actions. Buyer will fully indemnify TI and its representatives against any damages arising out of the use of any TI components in safety-critical applications.

In some cases, TI components may be promoted specifically to facilitate safety-related applications. With such components, TI's goal is to help enable customers to design and create their own end-product solutions that meet applicable functional safety standards and requirements. Nonetheless, such components are subject to these terms.

No TI components are authorized for use in FDA Class III (or similar life-critical medical equipment) unless authorized officers of the parties have executed a special agreement specifically governing such use.

Only those TI components which TI has specifically designated as military grade or "enhanced plastic" are designed and intended for use in military/aerospace applications or environments. Buyer acknowledges and agrees that any military or aerospace use of TI components which have **not** been so designated is solely at the Buyer's risk, and that Buyer is solely responsible for compliance with all legal and regulatory requirements in connection with such use.

TI has specifically designated certain components as meeting ISO/TS16949 requirements, mainly for automotive use. In any case of use of non-designated products, TI will not be responsible for any failure to meet ISO/TS16949.

### Products

Audio	<a href="http://www.ti.com/audio">www.ti.com/audio</a>
Amplifiers	<a href="http://amplifier.ti.com">amplifier.ti.com</a>
Data Converters	<a href="http://dataconverter.ti.com">dataconverter.ti.com</a>
DLP® Products	<a href="http://www.dlp.com">www.dlp.com</a>
DSP	<a href="http://dsp.ti.com">dsp.ti.com</a>
Clocks and Timers	<a href="http://www.ti.com/clocks">www.ti.com/clocks</a>
Interface	<a href="http://interface.ti.com">interface.ti.com</a>
Logic	<a href="http://logic.ti.com">logic.ti.com</a>
Power Mgmt	<a href="http://power.ti.com">power.ti.com</a>
Microcontrollers	<a href="http://microcontroller.ti.com">microcontroller.ti.com</a>
RFID	<a href="http://www.ti-rfid.com">www.ti-rfid.com</a>
OMAP Applications Processors	<a href="http://www.ti.com/omap">www.ti.com/omap</a>
Wireless Connectivity	<a href="http://www.ti.com/wirelessconnectivity">www.ti.com/wirelessconnectivity</a>

### Applications

Automotive and Transportation	<a href="http://www.ti.com/automotive">www.ti.com/automotive</a>
Communications and Telecom	<a href="http://www.ti.com/communications">www.ti.com/communications</a>
Computers and Peripherals	<a href="http://www.ti.com/computers">www.ti.com/computers</a>
Consumer Electronics	<a href="http://www.ti.com/consumer-apps">www.ti.com/consumer-apps</a>
Energy and Lighting	<a href="http://www.ti.com/energy">www.ti.com/energy</a>
Industrial	<a href="http://www.ti.com/industrial">www.ti.com/industrial</a>
Medical	<a href="http://www.ti.com/medical">www.ti.com/medical</a>
Security	<a href="http://www.ti.com/security">www.ti.com/security</a>
Space, Avionics and Defense	<a href="http://www.ti.com/space-avionics-defense">www.ti.com/space-avionics-defense</a>
Video and Imaging	<a href="http://www.ti.com/video">www.ti.com/video</a>

### TI E2E Community

[e2e.ti.com](http://e2e.ti.com)