

LMV981 SINGLE, LMV982 DUAL 1.8-V OPERATIONAL AMPLIFIERS WITH RAIL-TO-RAIL INPUT AND OUTPUT AND SHUTDOWN

SLOS440H – AUGUST 2004 – REVISED JULY 2007

- 1.8-V, 2.7-V, and 5-V Specifications
- Rail-to-Rail Output Swing
 - 600-Ω Load . . . 80 mV From Rail
 - 2-kΩ Load . . . 30 mV From Rail
- V_{ICR} . . . 200 mV Beyond Rails
- Gain Bandwidth . . . 1.4 MHz
- Supply Current . . . 100 μA/Amplifier
- Max V_{IO} . . . 4 mV
- Turn-On Time From Shutdown . . . 8.4 μs
- Space-Saving Packages
 - LMV981: SOT-23-6, SC-70, and QFN
 - LMV982: MSOP and VSSOP
- Applications
 - Industrial (Utility/Energy Metering)
 - Automotive
 - Communications (Optical Telecom, Data/Voice Cable Modems)
 - Consumer Electronics (PDAs, PCs, CDR/W, Portable Audio)
 - Supply-Current Monitoring
 - Battery Monitoring

LMV981 . . . DBV (SOT23-6) OR DCK (SC-70) PACKAGE
(TOP VIEW)

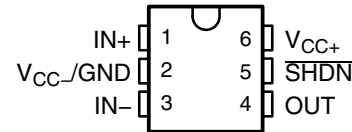

LMV981 . . . RUG (QFN) PACKAGE
(TOP VIEW)

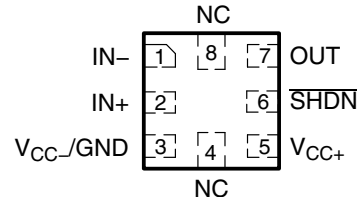

NC – No internal connection

LMV982 . . . DGS (VSSOP/MSOP) PACKAGE
(TOP VIEW)

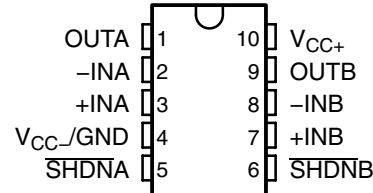

description/ordering information

The LMV981 and LMV982 devices are low-voltage, low-power operational amplifiers that are well suited for today's low-voltage and/or portable applications. Specified for operation of 1.8 V to 5 V, they can be used in portable applications that are powered from a single-cell Li-ion or two-cell batteries. They have rail-to-rail input and output capability for maximum signal swings in low-voltage applications. The LMV98x input common-mode voltage extends 200 mV beyond the rails for increased flexibility. The output can swing rail-to-rail unloaded and typically can reach 80 mV from the rails, while driving a 600-Ω load (at 1.8-V operation).

ORDERING INFORMATION†

T_A	PACKAGE‡			ORDERABLE PART NUMBER	TOP-SIDE MARKING§
–40°C to 125°C	Single	QFN (RUG)	Reel of 3000	LMV981IRUGR	R7
		SOT-23 (DBV)	Reel of 3000	LMV981IDBVR	RBA_
			Reel of 250	LMV981IDBVT	PREVIEW
		SC-70 (DCK)	Reel of 3000	LMV981IDCKR	R7_
	Reel of 250		LMV981IDCKT	PREVIEW	
	Dual	MSOP/VSSOP (DGS)	Reel of 2500	LMV982IDGSR	RCB
Reel of 250			LMV982IDGST		

† For the most current package and ordering information, see the Package Option Addendum at the end of this document, or see the TI web site at www.ti.com.

‡ Package drawings, thermal data, and symbolization are available at www.ti.com/packaging.

§ DBV/DCK: The actual top-side marking has one additional character that designates the wafer fab/assembly site.



Please be aware that an important notice concerning availability, standard warranty, and use in critical applications of Texas Instruments semiconductor products and disclaimers thereto appears at the end of this data sheet.

PRODUCTION DATA information is current as of publication date. Products conform to specifications per the terms of Texas Instruments standard warranty. Production processing does not necessarily include testing of all parameters.



POST OFFICE BOX 655303 • DALLAS, TEXAS 75265

Copyright © 2007, Texas Instruments Incorporated

LMV981 SINGLE, LMV982 DUAL 1.8-V OPERATIONAL AMPLIFIERS WITH RAIL-TO-RAIL INPUT AND OUTPUT AND SHUTDOWN

SLOS440H – AUGUST 2004 – REVISED JULY 2007

description/ordering information (continued)

The LMV981 and LMV982 devices offer shutdown capability for additional power savings. Pulling the SHDN pin low puts the amplifiers in shutdown, where only 0.156 μA typically is consumed from a 1.8-V supply. In normal operation with the same 1.8-V supply, the devices typically consume a quiescent current of 103 μA per channel, and yet they are able to achieve excellent electrical specifications, such as 101-dB open-loop DC gain and 1.4-MHz-gain bandwidth. Furthermore, the amplifiers offer good output drive characteristics, with the ability to drive a 600- Ω load and 1000-pF capacitance, with minimal ringing.

The LMV981 and LMV982 devices are offered in the latest packaging technology to meet the most demanding space-constraint applications. The LMV981 is offered in standard SOT-23 and SC-70 packages. The LMV982 is available in the 10-pin MSOP package.

The LMV98x devices are characterized for operation from -40°C to 125°C , making them universally suited for commercial, industrial, and automotive applications.

simplified schematic

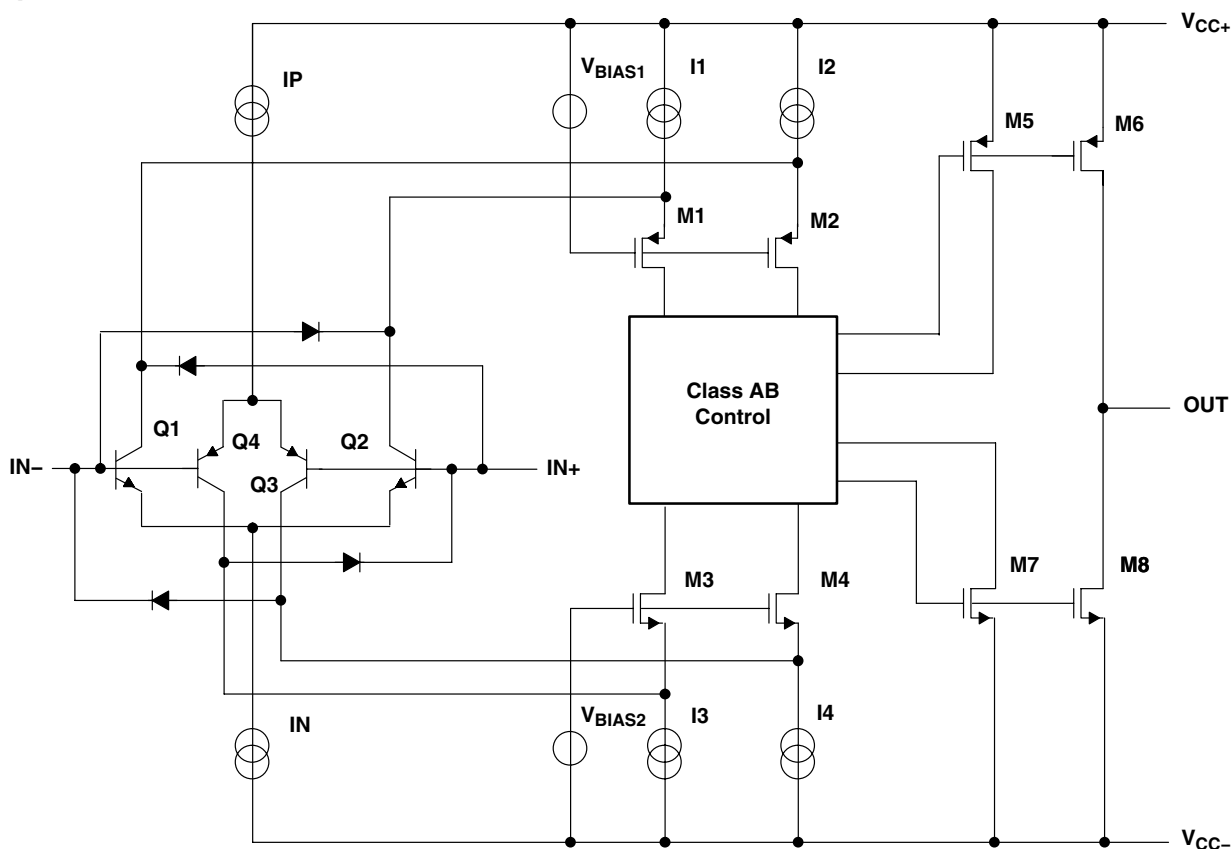

LMV981 SINGLE, LMV982 DUAL 1.8-V OPERATIONAL AMPLIFIERS WITH RAIL-TO-RAIL INPUT AND OUTPUT AND SHUTDOWN

SLOS440H – AUGUST 2004 – REVISED JULY 2007

absolute maximum ratings over free-air temperature range (unless otherwise noted)†

Supply voltage, $V_{CC+} - V_{CC-}$ (see Note 1)	5.5 V
Differential input voltage, V_{ID} (see Note 2)	Supply voltage
Input voltage range, V_I (either input)	$V_{CC-} - 0.2$ V to $V_{CC+} + 0.2$ V
Duration of output short circuit (one amplifier) to $V_{CC\pm}$ (see Notes 3 and 4)	Unlimited
Package thermal impedance, θ_{JA} (see Notes 4 and 5):	
DBV package	165°C/W
DCK package	259°C/W
DGS package	165°C/W
RUG package	253°C/W
Operating virtual junction temperature, T_J	150°C
Storage temperature range, T_{stg}	-65 to 150°C

† Stresses beyond those listed under “absolute maximum ratings” may cause permanent damage to the device. These are stress ratings only, and functional operation of the device at these or any other conditions beyond those indicated under “recommended operating conditions” is not implied. Exposure to absolute-maximum-rated conditions for extended periods may affect device reliability.

- NOTES:
- All voltage values (except differential voltages and V_{CC} specified for the measurement of I_{OS}) are with respect to the network GND.
 - Differential voltages are at $IN+$ with respect to $IN-$.
 - Applies to both single-supply and split-supply operation. Continuous short-circuit operation at elevated ambient temperature can result in exceeding the maximum-allowed junction temperature of 150°C. Output currents in excess of 45 mA over long term may adversely affect reliability.
 - Maximum power dissipation is a function of $T_J(\max)$, θ_{JA} , and T_A . The maximum allowable power dissipation at any allowable ambient temperature is $P_D = (T_J(\max) - T_A)/\theta_{JA}$. Operating at the absolute maximum T_J of 150°C can affect reliability.
 - The package thermal impedance is calculated in accordance with JESD 51-7.

recommended operating conditions

	MIN	MAX	UNIT
V_{CC} Supply voltage ($V_{CC+} - V_{CC-}$)	1.8	5	V
T_A Operating free-air temperature	-40	125	°C

ESD protection

TEST CONDITIONS	TYP	UNIT
Human-Body Model	2000	V
Machine Model	200	V

LMV981 SINGLE, LMV982 DUAL

1.8-V OPERATIONAL AMPLIFIERS

WITH RAIL-TO-RAIL INPUT AND OUTPUT AND SHUTDOWN

SLOS440H – AUGUST 2004 – REVISED JULY 2007

electrical characteristics at $T_A = 25^\circ\text{C}$, $V_{CC+} = 1.8\text{ V}$, $V_{CC-} = 0\text{ V}$, $V_{IC} = V_{CC+}/2$, $V_O = V_{CC+}/2$, $R_L > 1\text{ M}\Omega$, and SHDN tied to V_{CC+} (unless otherwise noted)

PARAMETER		TEST CONDITIONS		T_A	MIN	TYP	MAX	UNIT
V_{IO}	Input offset voltage	LMV981 (single)		25°C		1	4	mV
				Full range			6	
		LMV982 (dual)		25°C		1	5.5	
				Full range			7.5	
$\alpha_{V_{IO}}$	Average temperature coefficient of input offset voltage			25°C		5.5		$\mu\text{V}/^\circ\text{C}$
I_{IB}	Input bias current	$V_{IC} = V_{CC+} - 0.8\text{ V}$		25°C		15	35	nA
				25°C			65	
				Full range			75	
I_{IO}	Input offset current			25°C		13	25	nA
				Full range			40	
I_{CC}	Supply current (per channel)			25°C		103	185	μA
				Full range			205	
		In shutdown	LMV981	25°C		0.156	1	
				Full range			2	
			LM982	25°C		0.178	3.5	
				Full range			5	
CMRR	Common-mode rejection ratio	$0 \leq V_{IC} \leq 0.6\text{ V}$, $1.4\text{ V} \leq V_{IC} \leq 1.8\text{ V}$		25°C	60	78	dB	
				-40°C to 85°C	55			
		$0.2\text{ V} \leq V_{IC} \leq 0.6\text{ V}$, $1.4\text{ V} \leq V_{IC} \leq 1.6\text{ V}$		-40°C to 125°C	55			
				25°C	50	72		
k_{SVR}	Supply-voltage rejection ratio	$1.8\text{ V} \leq V_{CC+} \leq 5\text{ V}$, $V_{IC} = 0.5\text{ V}$		25°C	75	100	dB	
				Full range	70			
V_{ICR}	Common-mode input voltage range	$\text{CMRR} \geq 50\text{ dB}$		25°C	$V_{CC-} - 0.2$	-0.2 to 2.1	$V_{CC+} + 0.2$	V
				-40°C to 85°C	V_{CC-}		V_{CC+}	
				-40°C to 125°C	$V_{CC-} + 0.2$		$V_{CC+} - 0.2$	
A_V	Large-signal voltage gain	LMV981	$R_L = 600\ \Omega$ to 0.9 V , $V_O = 0.2\text{ V}$ to 1.6 V , $V_{IC} = 0.5\text{ V}$		25°C	77	101	dB
					Full range	73		
			$R_L = 2\text{ k}\Omega$ to 0.9 V , $V_O = 0.2\text{ V}$ to 1.6 V , $V_{IC} = 0.5\text{ V}$		25°C	80	105	
					Full range	75		
		LMV982	$R_L = 600\ \Omega$ to 0.9 V , $V_O = 0.2\text{ V}$ to 1.6 V , $V_{IC} = 0.5\text{ V}$		25°C	75	90	
					Full range	72		
$R_L = 2\text{ k}\Omega$ to 0.9 V , $V_O = 0.2\text{ V}$ to 1.6 V , $V_{IC} = 0.5\text{ V}$		25°C	78	100				
		Full range	75					

LMV981 SINGLE, LMV982 DUAL 1.8-V OPERATIONAL AMPLIFIERS WITH RAIL-TO-RAIL INPUT AND OUTPUT AND SHUTDOWN

SLOS440H – AUGUST 2004 – REVISED JULY 2007

electrical characteristics at $T_A = 25^\circ\text{C}$, $V_{CC+} = 1.8\text{ V}$, $V_{CC-} = 0\text{ V}$, $V_{IC} = V_{CC+}/2$, $V_O = V_{CC+}/2$, $R_L > 1\text{ M}\Omega$, and SHDN tied to V_{CC+} (unless otherwise noted) (continued)

PARAMETER		TEST CONDITIONS	T_A	MIN	TYP	MAX	UNIT
V_O	Output swing	$R_L = 600\ \Omega$ to 0.9 V , $V_{ID} = \pm 100\text{ mV}$	High level	25°C	1.65	1.72	V
				Full range	1.63		
			Low level	25°C	0.077 0.105		
				Full range	0.12		
		$R_L = 2\text{ k}\Omega$ to 0.9 V , $V_{ID} = \pm 100\text{ mV}$	High level	25°C	1.75	1.77	
				Full range	1.74		
			Low level	25°C	0.024 0.035		
				Full range	0.04		
I_{OS}	Output short-circuit current	$V_O = 0\text{ V}$, $V_{ID} = 100\text{ mV}$	Sourcing	25°C	4	8	mA
				Full range	3.3		
		$V_O = 1.8\text{ V}$, $V_{ID} = -100\text{ mV}$	Sinking	25°C	7	9	
				Full range	5		
T_{on}	Turn-on time from shutdown		25°C	19		μs	
V_{SHDN}	Turn-on voltage to enable part		25°C	1.0		V	
	Turn-off voltage			0.55			
GBW	Gain bandwidth product		25°C	1.4		MHz	
SR	Slew rate	See Note 6	25°C	0.35		$\text{V}/\mu\text{s}$	
Φ_m	Phase margin		25°C	67		deg	
	Gain margin		25°C	7		dB	
V_n	Equivalent input noise voltage	$f = 1\text{ kHz}$, $V_{IC} = 0.5\text{ V}$	25°C	60		$\text{nV}/\sqrt{\text{Hz}}$	
I_n	Equivalent input noise current	$f = 1\text{ kHz}$	25°C	0.06		$\text{pA}/\sqrt{\text{Hz}}$	
THD	Total harmonic distortion	$f = 1\text{ kHz}$, $A_V = 1$, $R_L = 600\ \Omega$, $V_{ID} = 1\text{ V}_{PP}$	25°C	0.023		%	
	Amp-to-amp isolation	See Note 7	25°C	123		dB	

- NOTES: 6. Number specified is the slower of the positive and negative slew rates.
7. Input referred, $V_{CC+} = 5\text{ V}$ and $R_L = 100\text{ k}\Omega$ connected to 2.5 V . Each amp is excited in turn with a 1-kHz signal to produce $V_O = 3\text{ V}_{PP}$.

LMV981 SINGLE, LMV982 DUAL 1.8-V OPERATIONAL AMPLIFIERS WITH RAIL-TO-RAIL INPUT AND OUTPUT AND SHUTDOWN

SLOS440H – AUGUST 2004 – REVISED JULY 2007

electrical characteristics at $T_A = 25^\circ\text{C}$, $V_{CC+} = 2.7\text{ V}$, $V_{CC-} = 0\text{ V}$, $V_{IC} = V_{CC+}/2$, $V_O = V_{CC+}/2$, $R_L > 1\text{ M}\Omega$, and SHDN tied to V_{CC+} (unless otherwise noted)

PARAMETER		TEST CONDITIONS		T_A	MIN	TYP	MAX	UNIT
V_{IO}	Input offset voltage	LMV981 (single)		25°C		1	4	mV
				Full range			6	
		LMV982 (dual)		25°C		1	5.5	
				Full range			7.5	
$\alpha_{V_{IO}}$	Average temperature coefficient of input offset voltage			25°C		5.5		$\mu\text{V}/^\circ\text{C}$
I_{IB}	Input bias current	$V_{IC} = V_{CC+} - 0.8\text{ V}$		25°C		15	35	nA
				25°C			65	
				Full range			75	
I_{IO}	Input offset current			25°C		8	25	nA
				Full range			40	
I_{CC}	Supply current (per channel)			25°C		105	190	μA
				Full range			210	
		In shutdown	LMV981	25°C		0.61	1	
				Full range			2	
			LMV982	25°C		0.101	3.5	
				Full range			5	
CMRR	Common-mode rejection ratio	$0 \leq V_{IC} \leq 1.5\text{ V}$, $2.3\text{ V} \leq V_{IC} \leq 2.7\text{ V}$		25°C	60	81	dB	
				–40°C to 85°C	55			
		$0.2 \leq V_{IC} \leq 1.5\text{ V}$, $2.3\text{ V} \leq V_{IC} \leq 2.5\text{ V}$		–40°C to 125°C	55			
				25°C	50	74		
k_{SVR}	Supply-voltage rejection ratio	$1.8\text{ V} \leq V_{CC+} \leq 5\text{ V}$, $V_{IC} = 0.5\text{ V}$		25°C	75	100	dB	
				Full range	70			
V_{ICR}	Common-mode input voltage range	CMRR $\geq 50\text{ dB}$		25°C	$V_{CC-} - 0.2$	–0.2 to 3.0	$V_{CC+} + 0.2$	V
				–40°C to 85°C	V_{CC-}		V_{CC+}	
				–40°C to 125°C	$V_{CC-} + 0.2$		$V_{CC+} - 0.2$	
A_V	Large-signal voltage gain	LMV981	$R_L = 600\ \Omega$ to 1.35 V, $V_O = 0.2\text{ V}$ to 2.5 V		25°C	87	104	dB
					Full range	86		
			$R_L = 2\text{ k}\Omega$ to 1.35 V, $V_O = 0.2\text{ V}$ to 2.5 V		25°C	92	110	
					Full range	91		
		LMV982	$R_L = 600\ \Omega$ to 1.35 V, $V_O = 0.2\text{ V}$ to 2.5 V		25°C	78	90	
					Full range	75		
			$R_L = 2\text{ k}\Omega$ to 1.35 V, $V_O = 0.2\text{ V}$ to 2.5 V		25°C	81	100	
					Full range	78		



LMV981 SINGLE, LMV982 DUAL 1.8-V OPERATIONAL AMPLIFIERS WITH RAIL-TO-RAIL INPUT AND OUTPUT AND SHUTDOWN

SLOS440H – AUGUST 2004 – REVISED JULY 2007

characteristics at $T_A = 25^\circ\text{C}$, $V_{CC+} = 2.7\text{ V}$, $V_{CC-} = 0\text{ V}$, $V_{IC} = V_{CC+}/2$, $V_O = V_{CC+}/2$, $R_L > 1\text{ M}\Omega$, and SHDN tied to V_{CC+} (unless otherwise noted) (continued)

PARAMETER		TEST CONDITIONS	T_A	MIN	TYP	MAX	UNIT
V_O	Output swing	$R_L = 600\ \Omega$ to 1.35 V, $V_{ID} = \pm 100\text{ mV}$	High level	25°C	2.55	2.62	V
				Full range	2.53		
			Low level	25°C	0.083 0.11		
				Full range	0.13		
		$R_L = 2\text{ k}\Omega$ to 1.35 V, $V_{ID} = \pm 100\text{ mV}$	High level	25°C	2.65	2.675	
				Full range	2.64		
			Low level	25°C	0.025 0.04		
				Full range	0.045		
I_{OS}	Output short-circuit current	$V_O = 0\text{ V}$, $V_{ID} = 100\text{ mV}$	Sourcing	25°C	20	30	mA
				Full range	15		
		$V_O = 2.7\text{ V}$, $V_{ID} = -100\text{ mV}$	Sinking	25°C	18	25	
				Full range	12		
T_{on}	Turn-on time from shutdown		25°C	12.5		μs	
V_{SHDN}	Turn-on voltage to enable part		25°C	1.9		V	
	Turn-off voltage			0.8			
GBW	Gain bandwidth product		25°C	1.4		MHz	
SR	Slew rate	See Note 6	25°C	0.4		$\text{V}/\mu\text{s}$	
Φ_m	Phase margin		25°C	70		deg	
	Gain margin		25°C	7.5		dB	
V_n	Equivalent input noise voltage	$f = 1\text{ kHz}$, $V_{IC} = 0.5\text{ V}$	25°C	57		$\text{nV}/\sqrt{\text{Hz}}$	
I_n	Equivalent input noise current	$f = 1\text{ kHz}$	25°C	0.082		$\text{pA}/\sqrt{\text{Hz}}$	
THD	Total harmonic distortion	$f = 1\text{ kHz}$, $A_V = 1$, $R_L = 600\ \Omega$, $V_{ID} = 1\text{ V}_{PP}$	25°C	0.022		%	
	Amp-to-amp isolation	See Note 7	25°C	123		dB	

- NOTES: 6. Number specified is the slower of the positive and negative slew rates.
7. Input referred, $V_{CC+} = 5\text{ V}$ and $R_L = 100\text{ k}\Omega$ connected to 2.5 V. Each amp is excited in turn with a 1-kHz signal to produce $V_O = 3\text{ V}_{PP}$.

LMV981 SINGLE, LMV982 DUAL

1.8-V OPERATIONAL AMPLIFIERS

WITH RAIL-TO-RAIL INPUT AND OUTPUT AND SHUTDOWN

SLOS440H – AUGUST 2004 – REVISED JULY 2007

electrical characteristics at $T_A = 25^\circ\text{C}$, $V_{CC+} = 5\text{ V}$, $V_{CC-} = 0\text{ V}$, $V_{IC} = V_{CC+}/2$, $V_O = V_{CC+}/2$, $R_L > 1\text{ M}\Omega$, and SHDN tied to V_{CC+} (unless otherwise noted)

PARAMETER		TEST CONDITIONS		T_A	MIN	TYP	MAX	UNIT
V_{IO}	Input offset voltage	LMV981 (single)		25°C		1	4	mV
				Full range			6	
		LMV982 (dual)		25°C		1	5.5	
				Full range			7.5	
$\alpha_{V_{IO}}$	Average temperature coefficient of input offset voltage			25°C		5.5		$\mu\text{V}/^\circ\text{C}$
I_{IB}	Input bias current	$V_{IC} = V_{CC+} - 0.8\text{ V}$		25°C		15	35	nA
				25°C			65	
				Full range			75	
I_{IO}	Input offset current			25°C		9	25	nA
				Full range			40	
I_{CC}	Supply current (per channel)			25°C		116	210	μA
				Full range			230	
		In shutdown	LMV981	25°C		0.201	1	
				Full range			2	
			LMV982	25°C		0.302	3.5	
				Full range			5	
CMRR	Common-mode rejection ratio	$0 \leq V_{IC} \leq 3.8\text{ V}$, $4.6\text{ V} \leq V_{IC} \leq 5\text{ V}$		25°C	60	86	dB	
				-40°C to 85°C	55			
		$0.3 \leq V_{IC} \leq 3.8\text{ V}$, $4.6\text{ V} \leq V_{IC} \leq 4.7\text{ V}$		-40°C to 125°C	55			
				25°C	50	78		
k_{SVR}	Supply-voltage rejection ratio	$1.8\text{ V} \leq V_{CC+} \leq 5\text{ V}$, $V_{IC} = 0.5\text{ V}$		25°C	75	100	dB	
				Full range	70			
V_{ICR}	Common-mode input voltage range	CMRR $\geq 50\text{ dB}$		25°C	$V_{CC-} - 0.2$	-0.2 to 5.3	$V_{CC+} + 0.2$	V
				-40°C to 85°C	V_{CC-}		V_{CC+}	
				-40°C to 125°C	$V_{CC-} + 0.3$		$V_{CC+} - 0.3$	
A_V	Large-signal voltage gain	LMV981	$R_L = 600\ \Omega$ to 2.5 V , $V_O = 0.2\text{ V}$ to 4.8 V		25°C	88	102	dB
					Full range	87		
			$R_L = 2\text{ k}\Omega$ to 2.5 V , $V_O = 0.2\text{ V}$ to 4.8 V		25°C	94	113	
					Full range	93		
		LMV982	$R_L = 600\ \Omega$ to 2.5 V , $V_O = 0.2\text{ V}$ to 4.8 V		25°C	81	90	
					Full range	78		
			$R_L = 2\text{ k}\Omega$ to 2.5 V , $V_O = 0.2\text{ V}$ to 4.8 V		25°C	85	100	
					Full range	82		

LMV981 SINGLE, LMV982 DUAL 1.8-V OPERATIONAL AMPLIFIERS WITH RAIL-TO-RAIL INPUT AND OUTPUT AND SHUTDOWN

SLOS440H – AUGUST 2004 – REVISED JULY 2007

electrical characteristics at $T_A = 25^\circ\text{C}$, $V_{CC+} = 5\text{ V}$, $V_{CC-} = 0\text{ V}$, $V_{IC} = V_{CC+}/2$, $V_O = V_{CC+}/2$, $R_L > 1\text{ M}\Omega$, and SHDN tied to V_{CC+} (unless otherwise noted) (continued)

PARAMETER		TEST CONDITIONS	T_A	MIN	TYP	MAX	UNIT
V_O	Output swing	$R_L = 600\ \Omega$ to 2.5 V, $V_{ID} = \pm 100\text{ mV}$	High level	25°C	4.855	4.89	V
				Full range	4.835		
			Low level	25°C	0.12 0.16		
				Full range	0.18		
		$R_L = 2\text{ k}\Omega$ to 2.5 V, $V_{ID} = \pm 100\text{ mV}$	High level	25°C	4.945	4.967	
				Full range	4.935		
			Low level	25°C	0.037 0.065		
				Full range	0.075		
I_{OS}	Output short-circuit current	LMV981: $V_O = 0\text{ V}$, $V_{ID} = 100\text{ mV}$	Sourcing	25°C	80	100	mA
				Full range	68		
		$V_O = 5\text{ V}$, $V_{ID} = -100\text{ mV}$	Sinking	25°C	58	65	
				Full range	45		
T_{on}	Turn-on time from shutdown		25°C	8.4		μs	
V_{SHDN}	Turn-on voltage to enable part		25°C	4.2		V	
	Turn-off voltage			0.8			
GBW	Gain bandwidth product		25°C	1.5		MHz	
SR	Slew rate	See Note 6	25°C	0.42		$\text{V}/\mu\text{s}$	
Φ_m	Phase margin		25°C	71		deg	
	Gain margin		25°C	8		dB	
V_n	Equivalent input noise voltage	$f = 1\text{ kHz}$, $V_{IC} = 1\text{ V}$	25°C	50		$\text{nV}/\sqrt{\text{Hz}}$	
I_n	Equivalent input noise current	$f = 1\text{ kHz}$	25°C	0.07		$\text{pA}/\sqrt{\text{Hz}}$	
THD	Total harmonic distortion	$f = 1\text{ kHz}$, $A_V = 1$, $R_L = 600\ \Omega$, $V_{ID} = 1\text{ V}_{PP}$	25°C	0.022		%	
	Amp-to-amp isolation	See Note 7	25°C	123		dB	

- NOTES: 6. Number specified is the slower of the positive and negative slew rates.
7. Input referred, $V_{CC+} = 5\text{ V}$ and $R_L = 100\text{ k}\Omega$ connected to 2.5 V. Each amp is excited in turn with a 1-kHz signal to produce $V_O = 3\text{ V}_{PP}$.

LMV981 SINGLE, LMV982 DUAL 1.8-V OPERATIONAL AMPLIFIERS WITH RAIL-TO-RAIL INPUT AND OUTPUT AND SHUTDOWN

SLOS440H – AUGUST 2004 – REVISED JULY 2007

TYPICAL PERFORMANCE CHARACTERISTICS
Unless Otherwise Specified, $V_{CC+} = 5\text{ V}$, Single Supply, $T_A = 25^\circ\text{C}$

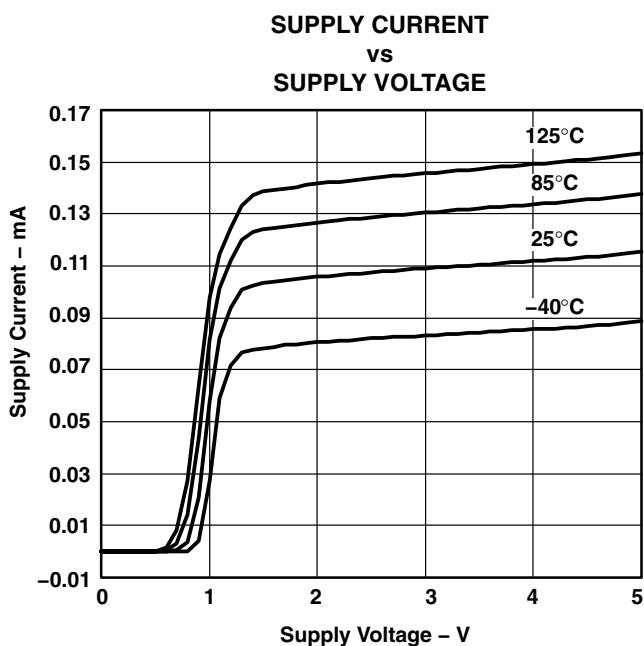

Figure 1

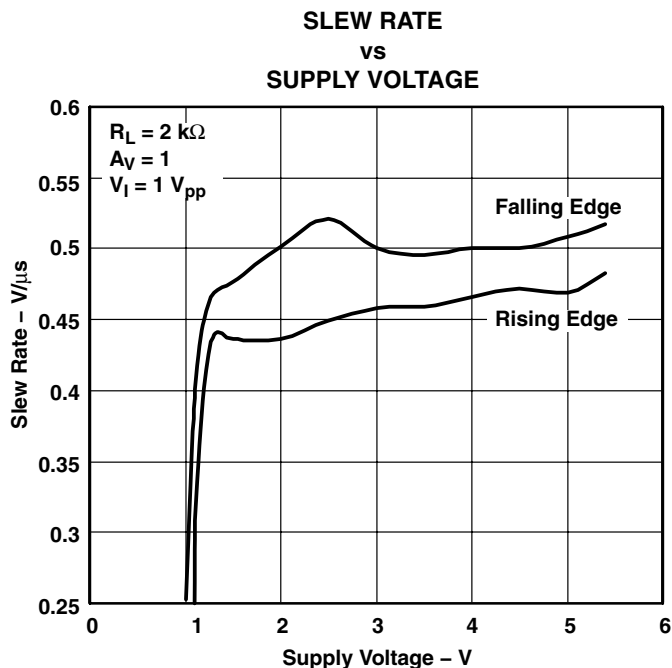

Figure 2

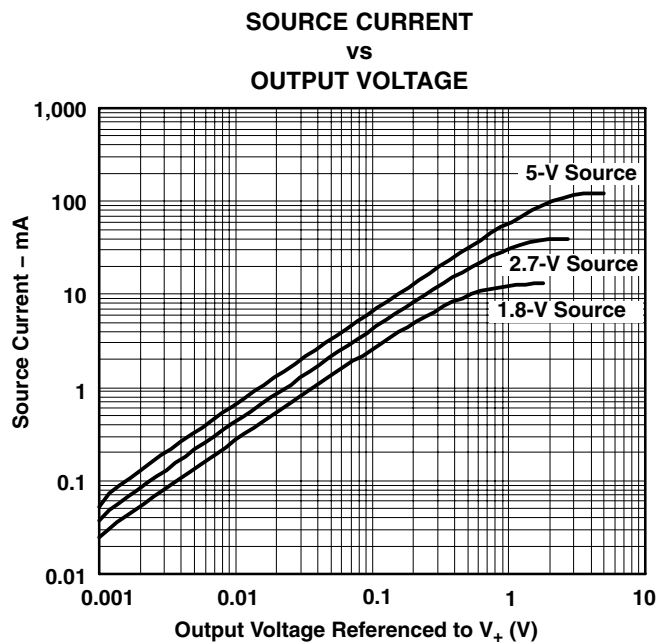

Figure 3

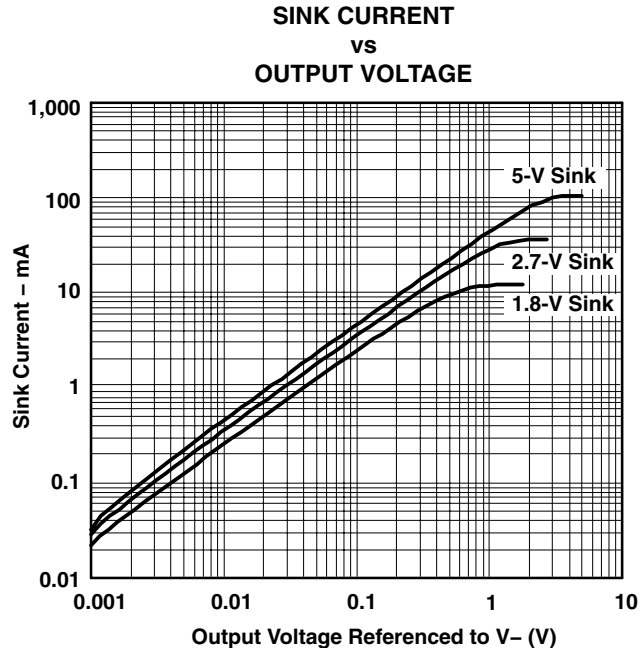

Figure 4

LMV981 SINGLE, LMV982 DUAL 1.8-V OPERATIONAL AMPLIFIERS WITH RAIL-TO-RAIL INPUT AND OUTPUT AND SHUTDOWN

SLOS440H – AUGUST 2004 – REVISED JULY 2007

TYPICAL PERFORMANCE CHARACTERISTICS Unless Otherwise Specified, $V_{CC+} = 5\text{ V}$, Single Supply, $T_A = 25^\circ\text{C}$

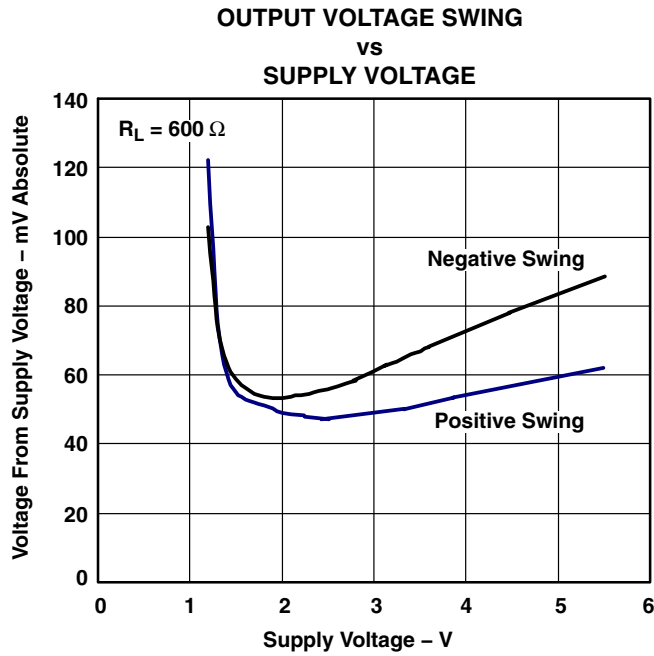

Figure 5

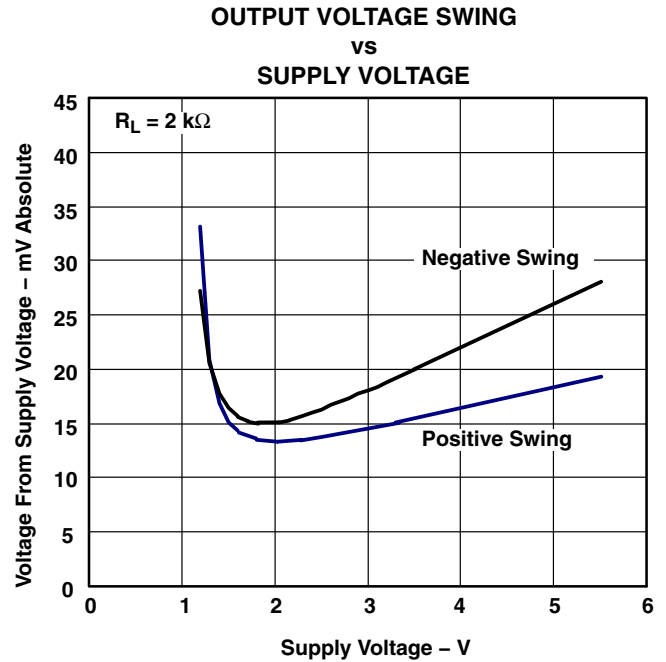

Figure 6

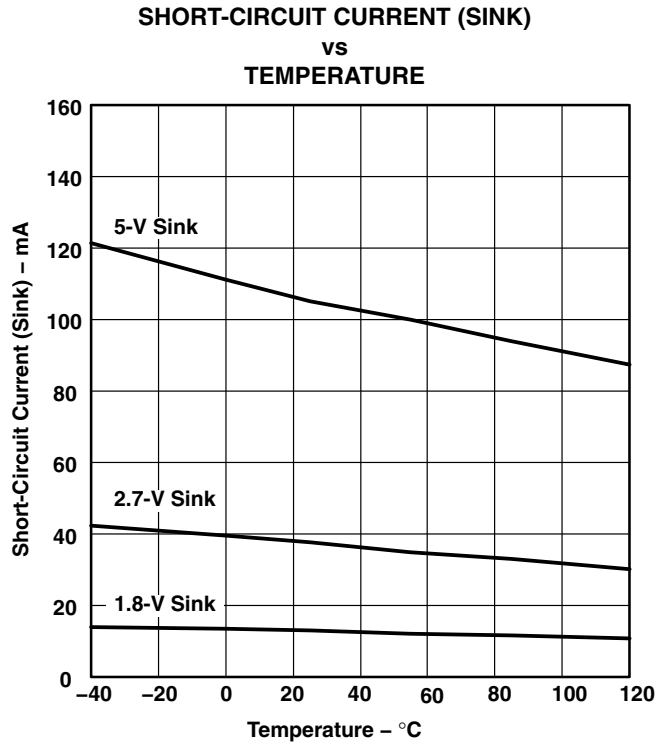

Figure 7

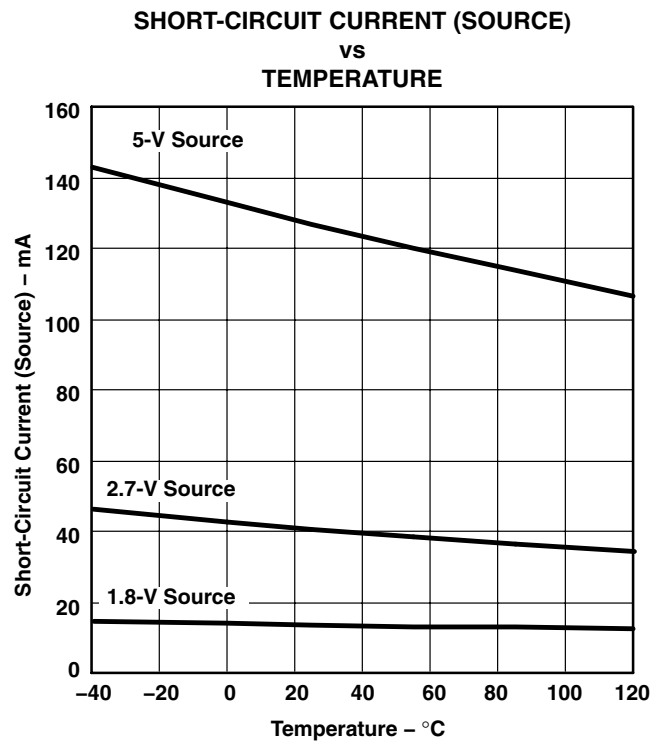

Figure 8

**LMV981 SINGLE, LMV982 DUAL
1.8-V OPERATIONAL AMPLIFIERS
WITH RAIL-TO-RAIL INPUT AND OUTPUT AND SHUTDOWN**

SLOS440H – AUGUST 2004 – REVISED JULY 2007

TYPICAL PERFORMANCE CHARACTERISTICS
Unless Otherwise Specified, $V_{CC+} = 5\text{ V}$, Single Supply, $T_A = 25^\circ\text{C}$

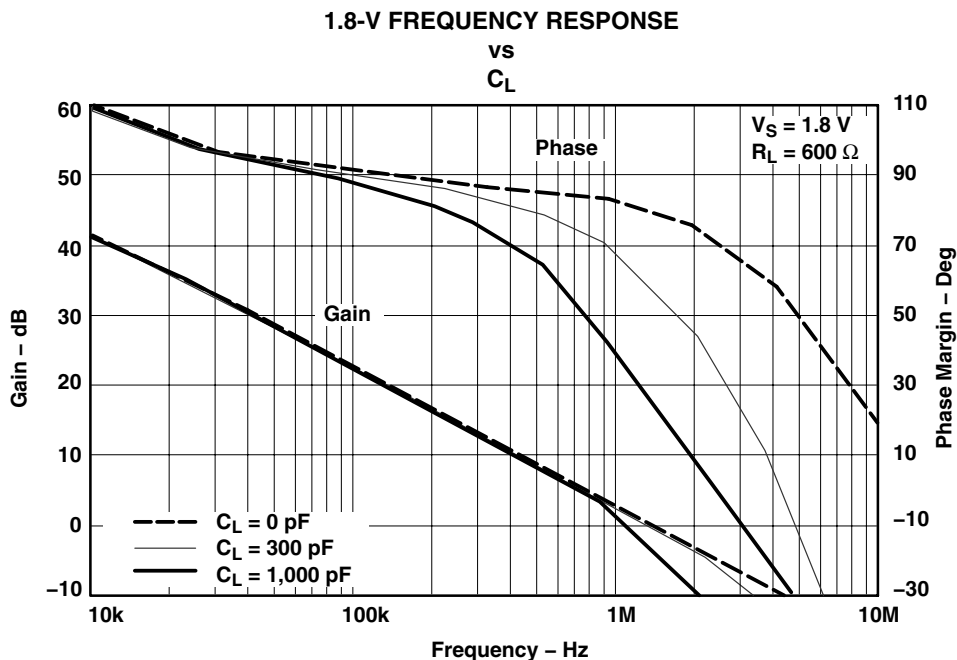

Figure 9

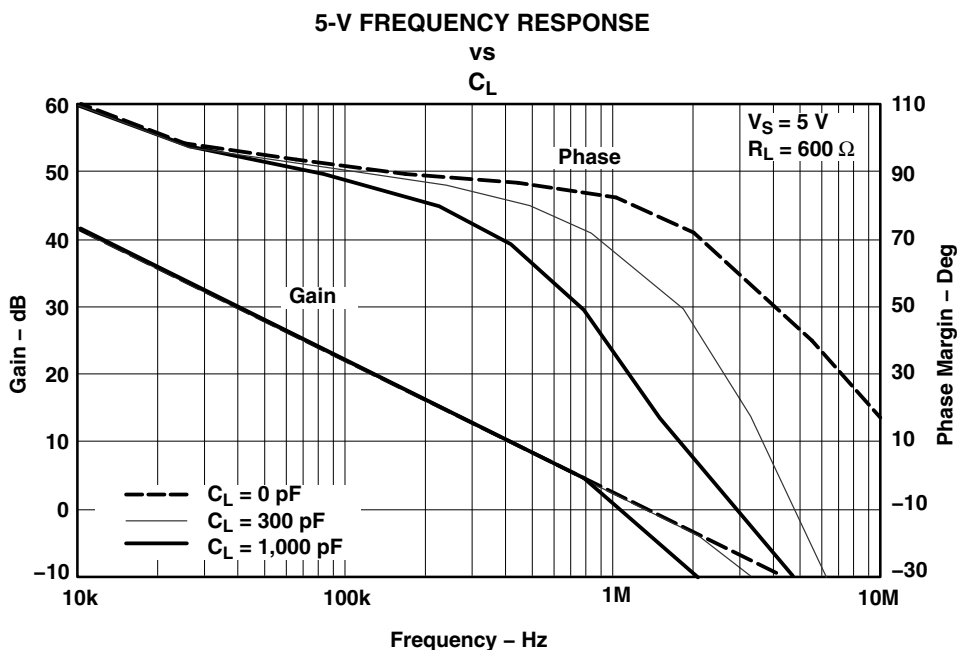

Figure 10

LMV981 SINGLE, LMV982 DUAL 1.8-V OPERATIONAL AMPLIFIERS WITH RAIL-TO-RAIL INPUT AND OUTPUT AND SHUTDOWN

SLOS440H – AUGUST 2004 – REVISED JULY 2007

TYPICAL PERFORMANCE CHARACTERISTICS Unless Otherwise Specified, $V_{CC+} = 5\text{ V}$, Single Supply, $T_A = 25^\circ\text{C}$

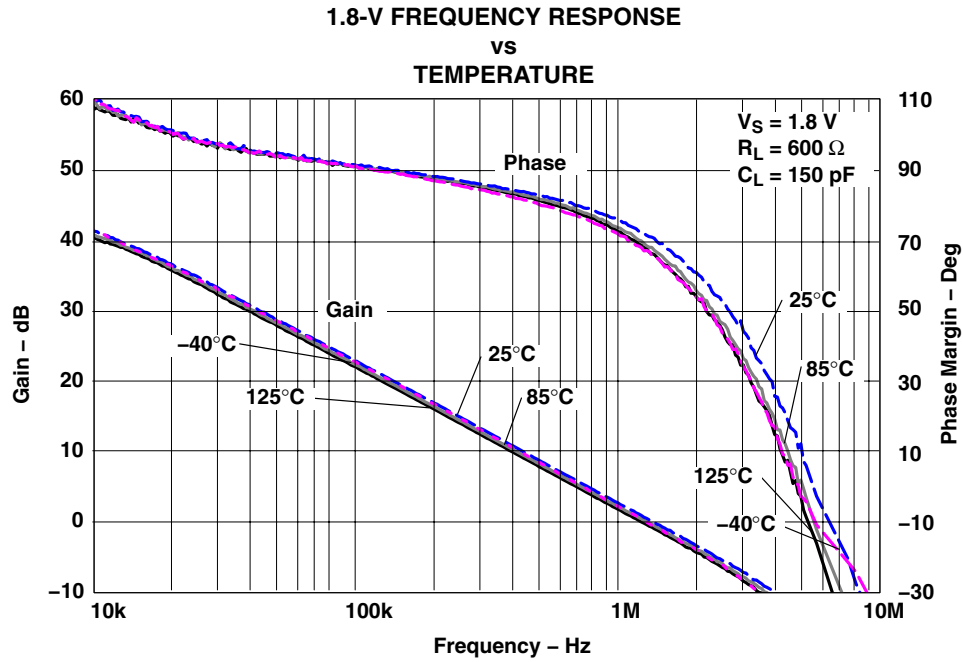

Figure 11

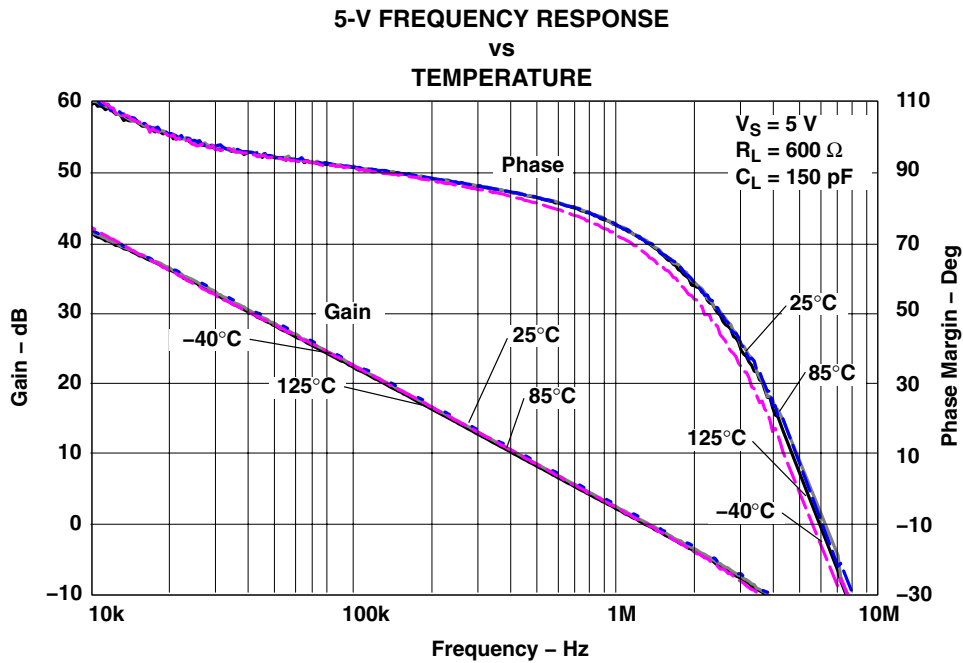

Figure 12

LMV981 SINGLE, LMV982 DUAL 1.8-V OPERATIONAL AMPLIFIERS WITH RAIL-TO-RAIL INPUT AND OUTPUT AND SHUTDOWN

SLOS440H – AUGUST 2004 – REVISED JULY 2007

TYPICAL PERFORMANCE CHARACTERISTICS Unless Otherwise Specified, $V_{CC+} = 5\text{ V}$, Single Supply, $T_A = 25^\circ\text{C}$

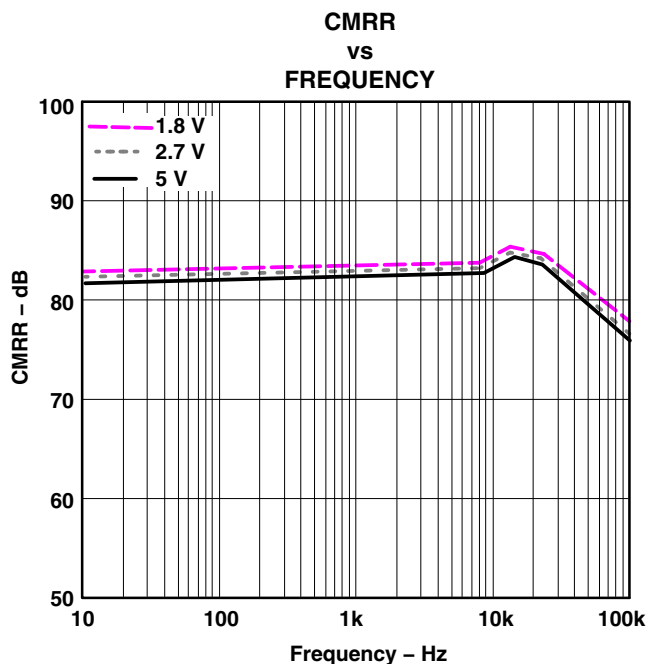

Figure 13

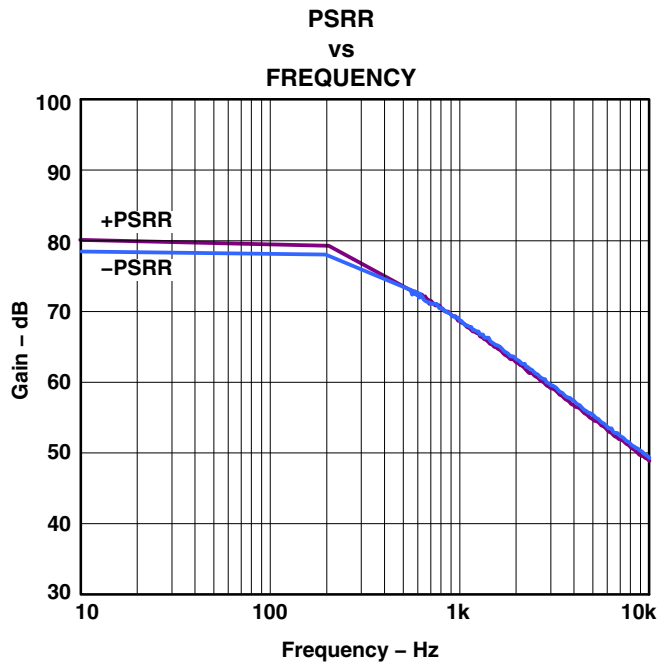

Figure 14

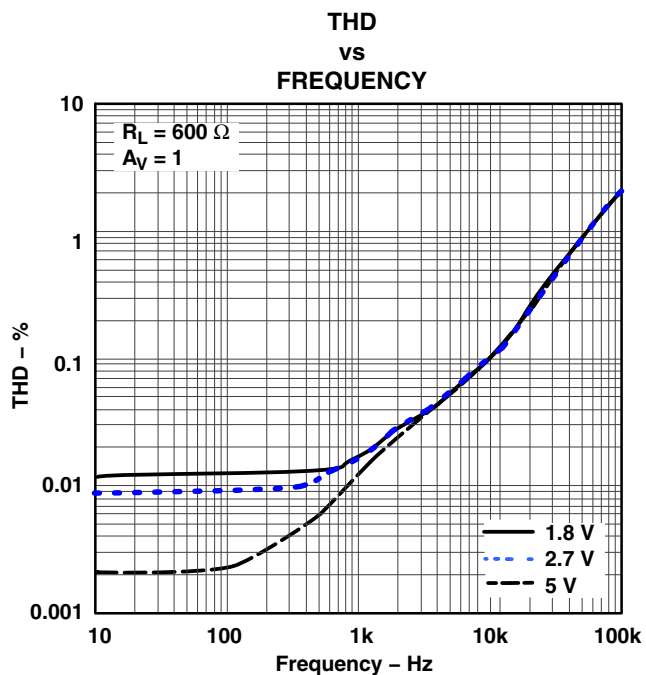

Figure 15

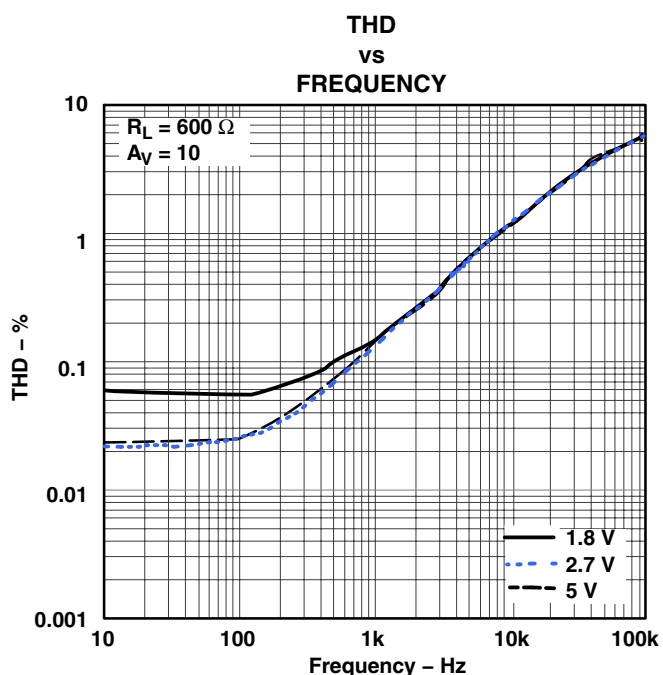

Figure 16

LMV981 SINGLE, LMV982 DUAL 1.8-V OPERATIONAL AMPLIFIERS WITH RAIL-TO-RAIL INPUT AND OUTPUT AND SHUTDOWN

SLOS440H – AUGUST 2004 – REVISED JULY 2007

TYPICAL PERFORMANCE CHARACTERISTICS Unless Otherwise Specified, $V_{CC+} = 5\text{ V}$, Single Supply, $T_A = 25^\circ\text{C}$

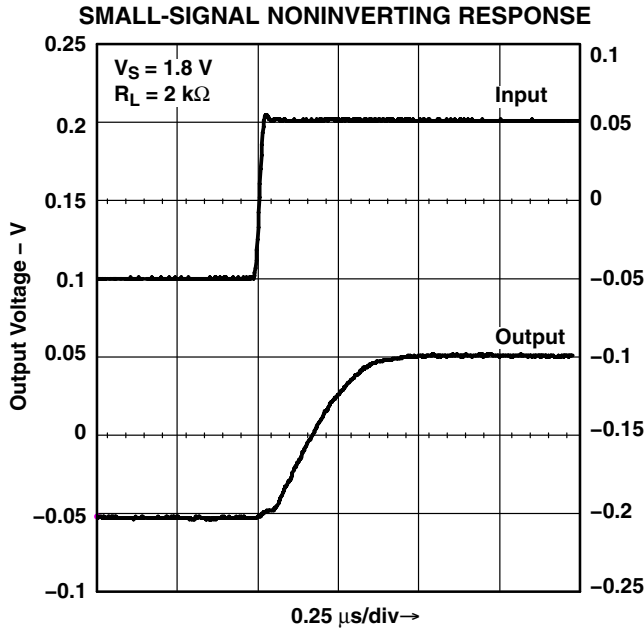

Figure 17

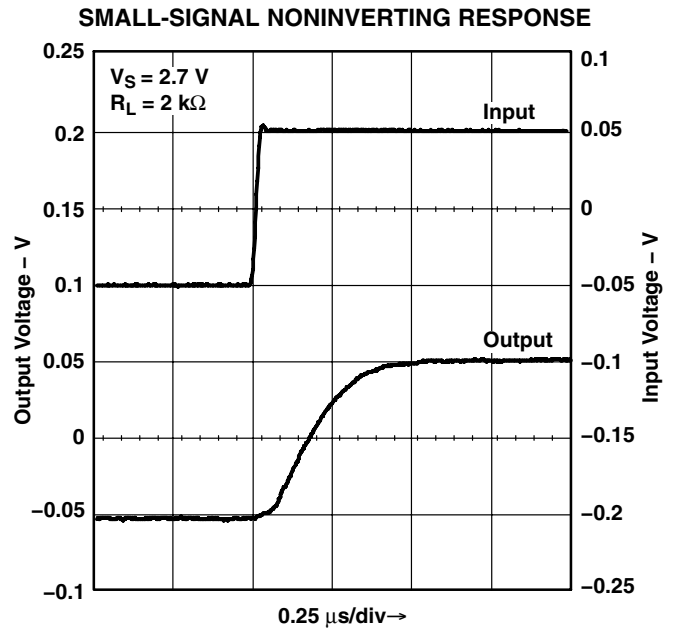

Figure 18

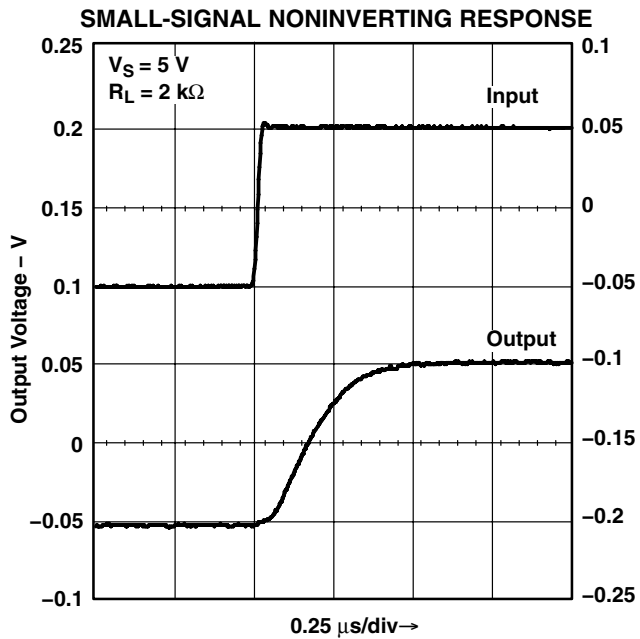

Figure 19

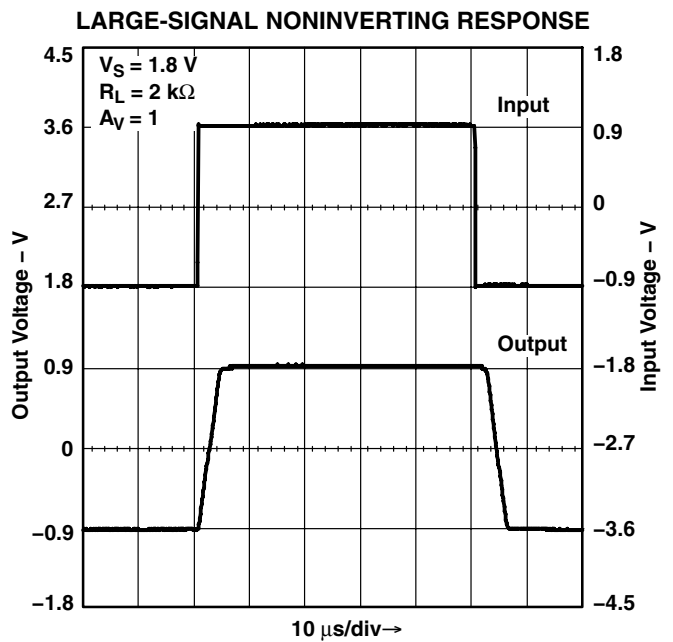

Figure 20

LMV981 SINGLE, LMV982 DUAL 1.8-V OPERATIONAL AMPLIFIERS WITH RAIL-TO-RAIL INPUT AND OUTPUT AND SHUTDOWN

SLOS440H – AUGUST 2004 – REVISED JULY 2007

TYPICAL PERFORMANCE CHARACTERISTICS Unless Otherwise Specified, $V_{CC+} = 5\text{ V}$, Single Supply, $T_A = 25^\circ\text{C}$

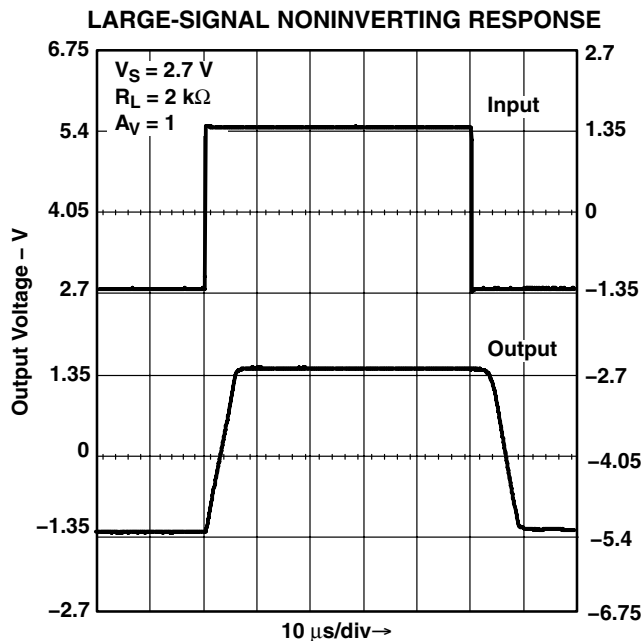

Figure 21

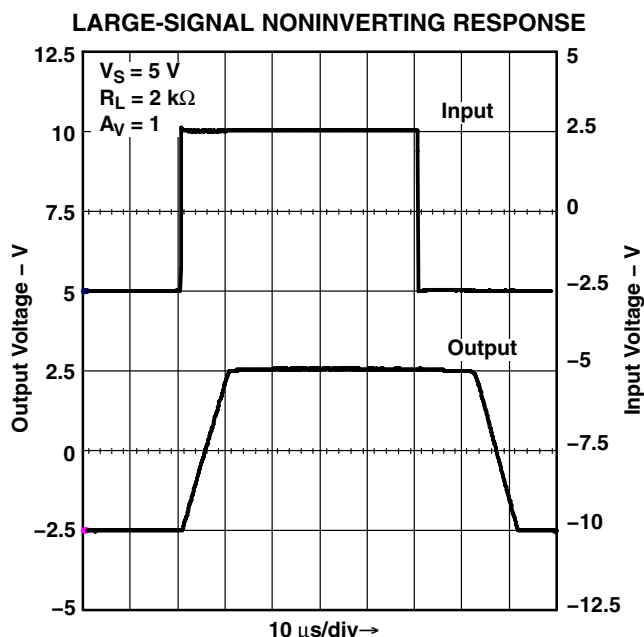

Figure 22

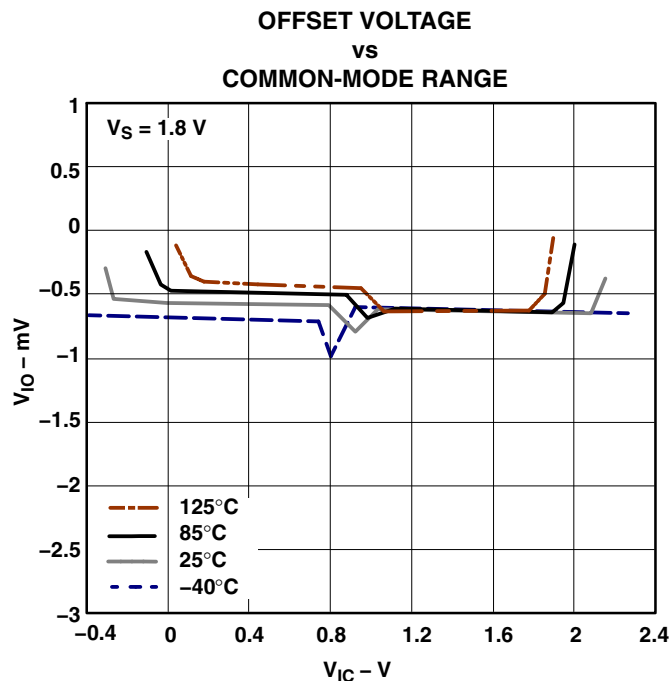

Figure 23

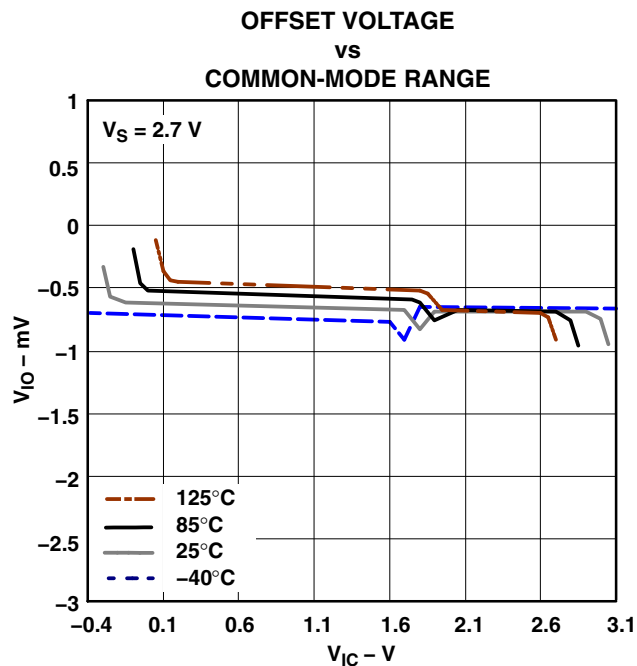

Figure 24

LMV981 SINGLE, LMV982 DUAL 1.8-V OPERATIONAL AMPLIFIERS WITH RAIL-TO-RAIL INPUT AND OUTPUT AND SHUTDOWN

SLOS440H – AUGUST 2004 – REVISED JULY 2007

TYPICAL PERFORMANCE CHARACTERISTICS
Unless Otherwise Specified, $V_{CC+} = 5\text{ V}$, Single Supply, $T_A = 25^\circ\text{C}$

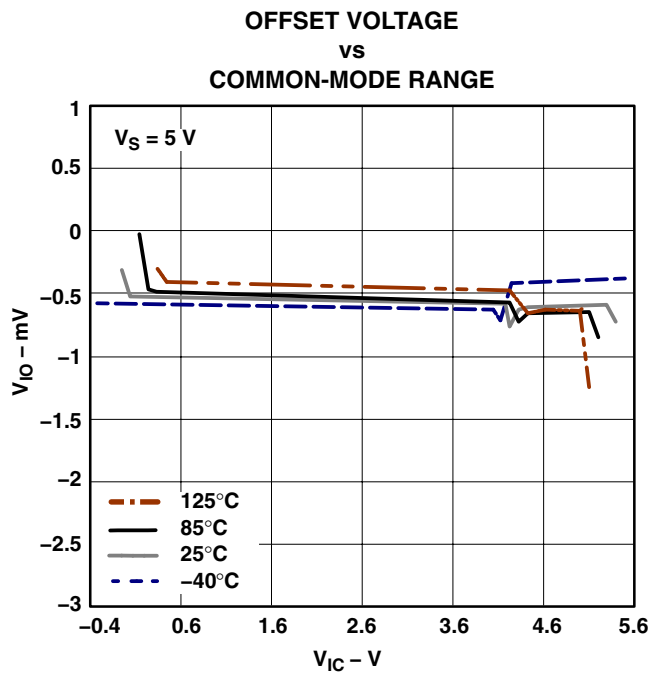

Figure 25

PACKAGING INFORMATION

Orderable Device	Status (1)	Package Type	Package Drawing	Pins	Package Qty	Eco Plan (2)	Lead/Ball Finish	MSL Peak Temp (3)	Op Temp (°C)	Top-Side Markings (4)	Samples
LMV981IDBVR	OBSOLETE	SOT-23	DBV	6		TBD	Call TI	Call TI	-40 to 125	RBA6	
LMV981IDBVRE4	OBSOLETE	SOT-23	DBV	6		TBD	Call TI	Call TI	-40 to 125		
LMV981IDBVRG4	OBSOLETE	SOT-23	DBV	6		TBD	Call TI	Call TI	-40 to 125		
LMV981IDCKR	OBSOLETE	SC70	DCK	6		TBD	Call TI	Call TI	-40 to 125	R76	
LMV981IDCKRE4	OBSOLETE	SC70	DCK	6		TBD	Call TI	Call TI	-40 to 125		
LMV981IDCKRG4	OBSOLETE	SC70	DCK	6		TBD	Call TI	Call TI	-40 to 125		
LMV981IRUGR	OBSOLETE	X2QFN	RUG	8		TBD	Call TI	Call TI	-40 to 125	R7	
LMV981IRUGRG4	OBSOLETE	X2QFN	RUG	8		TBD	Call TI	Call TI	-40 to 125		
LMV982IDGSR	OBSOLETE	VSSOP	DGS	10		TBD	Call TI	Call TI	-40 to 85	RCB	
LMV982IDGSRE4	OBSOLETE	VSSOP	DGS	10		TBD	Call TI	Call TI	-40 to 85		
LMV982IDGSRG4	OBSOLETE	VSSOP	DGS	10		TBD	Call TI	Call TI	-40 to 85		

(1) The marketing status values are defined as follows:

ACTIVE: Product device recommended for new designs.

LIFEBUY: TI has announced that the device will be discontinued, and a lifetime-buy period is in effect.

NRND: Not recommended for new designs. Device is in production to support existing customers, but TI does not recommend using this part in a new design.

PREVIEW: Device has been announced but is not in production. Samples may or may not be available.

OBSOLETE: TI has discontinued the production of the device.

(2) Eco Plan - The planned eco-friendly classification: Pb-Free (RoHS), Pb-Free (RoHS Exempt), or Green (RoHS & no Sb/Br) - please check <http://www.ti.com/productcontent> for the latest availability information and additional product content details.

TBD: The Pb-Free/Green conversion plan has not been defined.

Pb-Free (RoHS): TI's terms "Lead-Free" or "Pb-Free" mean semiconductor products that are compatible with the current RoHS requirements for all 6 substances, including the requirement that lead not exceed 0.1% by weight in homogeneous materials. Where designed to be soldered at high temperatures, TI Pb-Free products are suitable for use in specified lead-free processes.

Pb-Free (RoHS Exempt): This component has a RoHS exemption for either 1) lead-based flip-chip solder bumps used between the die and package, or 2) lead-based die adhesive used between the die and leadframe. The component is otherwise considered Pb-Free (RoHS compatible) as defined above.

Green (RoHS & no Sb/Br): TI defines "Green" to mean Pb-Free (RoHS compatible), and free of Bromine (Br) and Antimony (Sb) based flame retardants (Br or Sb do not exceed 0.1% by weight in homogeneous material)

(3) MSL, Peak Temp. -- The Moisture Sensitivity Level rating according to the JEDEC industry standard classifications, and peak solder temperature.

(4) Multiple Top-Side Markings will be inside parentheses. Only one Top-Side Marking contained in parentheses and separated by a "~" will appear on a device. If a line is indented then it is a continuation of the previous line and the two combined represent the entire Top-Side Marking for that device.

Important Information and Disclaimer: The information provided on this page represents TI's knowledge and belief as of the date that it is provided. TI bases its knowledge and belief on information provided by third parties, and makes no representation or warranty as to the accuracy of such information. Efforts are underway to better integrate information from third parties. TI has taken and continues to take reasonable steps to provide representative and accurate information but may not have conducted destructive testing or chemical analysis on incoming materials and chemicals. TI and TI suppliers consider certain information to be proprietary, and thus CAS numbers and other limited information may not be available for release.

In no event shall TI's liability arising out of such information exceed the total purchase price of the TI part(s) at issue in this document sold by TI to Customer on an annual basis.

DBV (R-PDSO-G6)

PLASTIC SMALL-OUTLINE PACKAGE



- NOTES:
- A. All linear dimensions are in millimeters.
 - B. This drawing is subject to change without notice.
 - C. Body dimensions do not include mold flash or protrusion. Mold flash and protrusion shall not exceed 0.15 per side.
 - D. Leads 1,2,3 may be wider than leads 4,5,6 for package orientation.
- \triangle Falls within JEDEC MO-178 Variation AB, except minimum lead width.

DGS (S-PDSO-G10)

PLASTIC SMALL-OUTLINE PACKAGE



- NOTES:
- A. All linear dimensions are in millimeters.
 - B. This drawing is subject to change without notice.
 - C. Body dimensions do not include mold flash or protrusion.
 - D. Falls within JEDEC MO-187 variation BA.

DCK (R-PDSO-G6)

PLASTIC SMALL-OUTLINE PACKAGE



- NOTES:
- A. All linear dimensions are in millimeters.
 - B. This drawing is subject to change without notice.
 - C. Body dimensions do not include mold flash or protrusion. Mold flash and protrusion shall not exceed 0.15 per side.
 - D. Falls within JEDEC MO-203 variation AB.

RUG (S-PQFP-N8)

PLASTIC QUAD FLATPACK

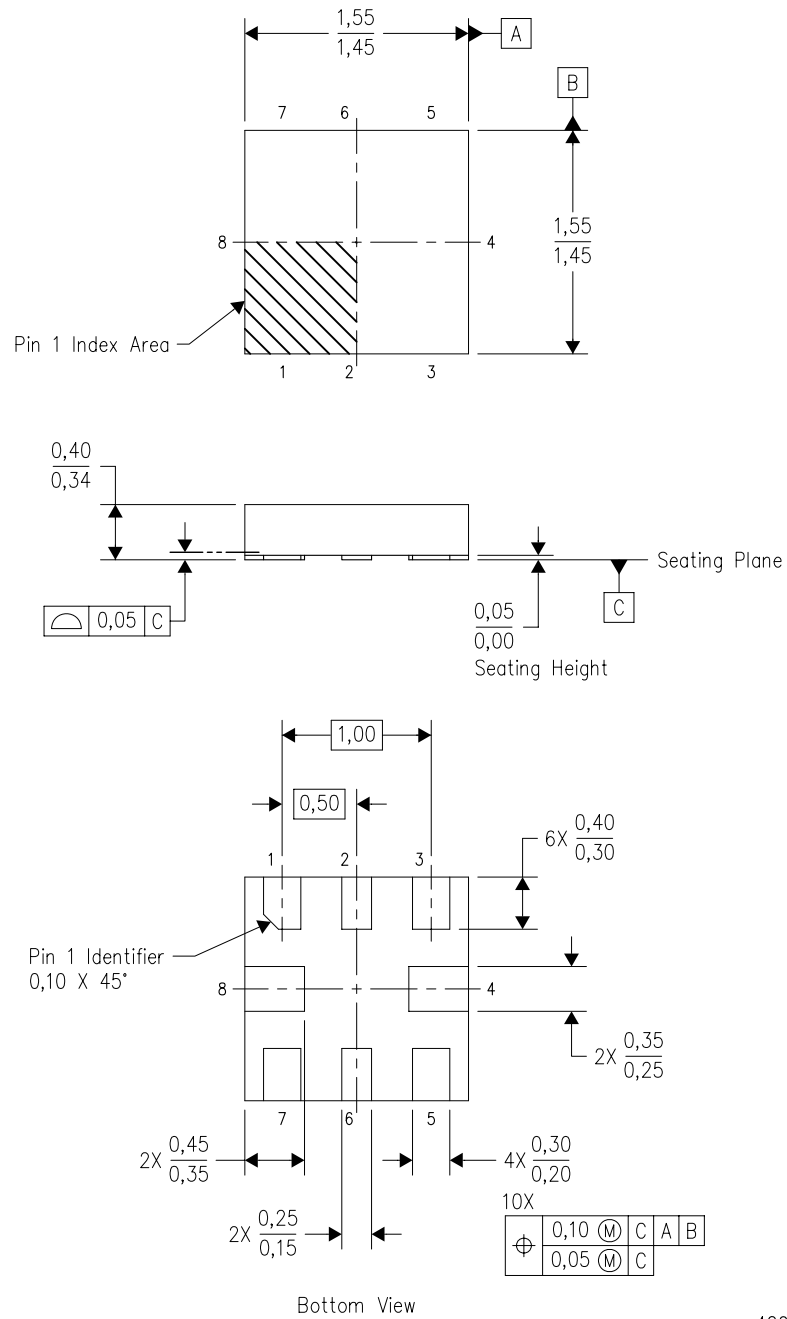

4208528-2/B 04/2008

- NOTES:
- All linear dimensions are in millimeters. Dimensioning and tolerancing per ASME Y14.5M-1994.
 - This drawing is subject to change without notice.
 - QFN (Quad Flatpack No-Lead) package configuration.
 - This package complies to JEDEC MO-288 variation X2ECD.

IMPORTANT NOTICE

Texas Instruments Incorporated and its subsidiaries (TI) reserve the right to make corrections, enhancements, improvements and other changes to its semiconductor products and services per JESD46, latest issue, and to discontinue any product or service per JESD48, latest issue. Buyers should obtain the latest relevant information before placing orders and should verify that such information is current and complete. All semiconductor products (also referred to herein as "components") are sold subject to TI's terms and conditions of sale supplied at the time of order acknowledgment.

TI warrants performance of its components to the specifications applicable at the time of sale, in accordance with the warranty in TI's terms and conditions of sale of semiconductor products. Testing and other quality control techniques are used to the extent TI deems necessary to support this warranty. Except where mandated by applicable law, testing of all parameters of each component is not necessarily performed.

TI assumes no liability for applications assistance or the design of Buyers' products. Buyers are responsible for their products and applications using TI components. To minimize the risks associated with Buyers' products and applications, Buyers should provide adequate design and operating safeguards.

TI does not warrant or represent that any license, either express or implied, is granted under any patent right, copyright, mask work right, or other intellectual property right relating to any combination, machine, or process in which TI components or services are used. Information published by TI regarding third-party products or services does not constitute a license to use such products or services or a warranty or endorsement thereof. Use of such information may require a license from a third party under the patents or other intellectual property of the third party, or a license from TI under the patents or other intellectual property of TI.

Reproduction of significant portions of TI information in TI data books or data sheets is permissible only if reproduction is without alteration and is accompanied by all associated warranties, conditions, limitations, and notices. TI is not responsible or liable for such altered documentation. Information of third parties may be subject to additional restrictions.

Resale of TI components or services with statements different from or beyond the parameters stated by TI for that component or service voids all express and any implied warranties for the associated TI component or service and is an unfair and deceptive business practice. TI is not responsible or liable for any such statements.

Buyer acknowledges and agrees that it is solely responsible for compliance with all legal, regulatory and safety-related requirements concerning its products, and any use of TI components in its applications, notwithstanding any applications-related information or support that may be provided by TI. Buyer represents and agrees that it has all the necessary expertise to create and implement safeguards which anticipate dangerous consequences of failures, monitor failures and their consequences, lessen the likelihood of failures that might cause harm and take appropriate remedial actions. Buyer will fully indemnify TI and its representatives against any damages arising out of the use of any TI components in safety-critical applications.

In some cases, TI components may be promoted specifically to facilitate safety-related applications. With such components, TI's goal is to help enable customers to design and create their own end-product solutions that meet applicable functional safety standards and requirements. Nonetheless, such components are subject to these terms.

No TI components are authorized for use in FDA Class III (or similar life-critical medical equipment) unless authorized officers of the parties have executed a special agreement specifically governing such use.

Only those TI components which TI has specifically designated as military grade or "enhanced plastic" are designed and intended for use in military/aerospace applications or environments. Buyer acknowledges and agrees that any military or aerospace use of TI components which have **not** been so designated is solely at the Buyer's risk, and that Buyer is solely responsible for compliance with all legal and regulatory requirements in connection with such use.

TI has specifically designated certain components as meeting ISO/TS16949 requirements, mainly for automotive use. In any case of use of non-designated products, TI will not be responsible for any failure to meet ISO/TS16949.

Products

Audio	www.ti.com/audio
Amplifiers	amplifier.ti.com
Data Converters	dataconverter.ti.com
DLP® Products	www.dlp.com
DSP	dsp.ti.com
Clocks and Timers	www.ti.com/clocks
Interface	interface.ti.com
Logic	logic.ti.com
Power Mgmt	power.ti.com
Microcontrollers	microcontroller.ti.com
RFID	www.ti-rfid.com
OMAP Applications Processors	www.ti.com/omap
Wireless Connectivity	www.ti.com/wirelessconnectivity

Applications

Automotive and Transportation	www.ti.com/automotive
Communications and Telecom	www.ti.com/communications
Computers and Peripherals	www.ti.com/computers
Consumer Electronics	www.ti.com/consumer-apps
Energy and Lighting	www.ti.com/energy
Industrial	www.ti.com/industrial
Medical	www.ti.com/medical
Security	www.ti.com/security
Space, Avionics and Defense	www.ti.com/space-avionics-defense
Video and Imaging	www.ti.com/video

TI E2E Community

e2e.ti.com