

Excaltbur™ LOW-NOISE HIGH-SPEED PRECISION OPERATIONAL AMPLIFIER

FEATURES

- **Qualified for Automotive Applications**
- **Low Noise**
 - 10 Hz: 15 nV/ $\sqrt{\text{Hz}}$
 - 1 kHz: 10.5 nV/ $\sqrt{\text{Hz}}$
- **10000-pF Load Capability**
- **20-mA Short-Circuit Output Current (Min)**
- **27-V/ μs Slew Rate (Min)**
- **High Gain-Bandwidth Product: 5.9 MHz**
- **Single or Split Supply: 4 V to 44 V**
- **Fast Settling Time**
 - 340 ns to 0.1%
 - 400 ns to 0.01%
- **Large Output Swing:**
 $V_{\text{CC-}} + 0.1 \text{ V}$ to $V_{\text{CC+}} - 1 \text{ V}$

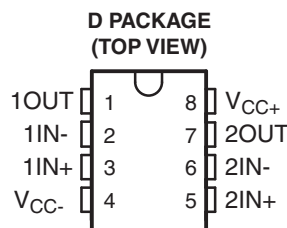

DESCRIPTION/ORDERING INFORMATION

The TLE2142 device is a high-performance, internally compensated operational amplifier built using the Texas Instruments complementary bipolar Excaltbur™ process. It is a pin-compatible upgrade to standard industry products.

The design incorporates an input stage that simultaneously achieves low audio-band noise of 10.5 nV/ $\sqrt{\text{Hz}}$ with a 10-Hz 1/f corner and symmetrical 40-V/ μs slew rate typically with loads up to 800 pF. The resulting low distortion and high power bandwidth are important in high-fidelity audio applications. A fast settling time of 340 ns to 0.1% of a 10-V step with a 2-k Ω /100-pF load is useful in fast actuator/positioning drivers. Under similar test conditions, settling time to 0.01% is 400 ns.

The device is stable with capacitive loads up to 10 nF, although the 6-MHz bandwidth decreases to 1.8 MHz at this high loading level. As such, the TLE2142 is useful for low-droop sample-and-holds and direct buffering of long cables, including 4-mA to 20-mA current loops.

The special design also exhibits an improved insensitivity to inherent integrated circuit component mismatches as is evidenced by a 500- μV maximum offset voltage and 1.7- $\mu\text{V}/^\circ\text{C}$ typical drift. Minimum common-mode rejection ratio and supply-voltage rejection ratio are 85 dB and 90 dB, respectively.

Device performance is relatively independent of supply voltage over the $\pm 2\text{-V}$ to $\pm 22\text{-V}$ range. Inputs can operate between $V_{\text{CC-}} - 0.3 \text{ V}$ to $V_{\text{CC+}} - 1.8 \text{ V}$ without inducing phase reversal, although excessive input current may flow out of each input exceeding the lower common-mode input range. The all-npn output stage provides a nearly rail-to-rail output swing of $V_{\text{CC-}} + 0.1 \text{ V}$ to $V_{\text{CC+}} - 1 \text{ V}$ under light current-loading conditions. The device can sustain shorts to either supply, because output current is internally limited, but care must be taken to ensure that maximum package power dissipation is not exceeded.

The TLE2142 can also be used as a comparator. Differential inputs of $V_{\text{CC}\pm}$ can be maintained without damage to the device. Open-loop propagation delay with TTL supply levels is typically 200 ns. This gives a good indication as to output stage saturation recovery when the device is driven beyond the limits of recommended output swing.

The TLE2142 device is available in industry-standard 8-pin small-outline (D) packages. The device is characterized for operation from -40°C to 125°C .



Please be aware that an important notice concerning availability, standard warranty, and use in critical applications of Texas Instruments semiconductor products and disclaimers thereto appears at the end of this data sheet.

Excaltbur is a trademark of Texas Instruments.

SYMBOL (EACH AMPLIFIER)

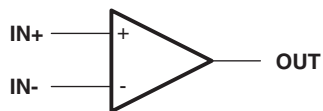
ORDERING INFORMATION⁽¹⁾

T_A	PACKAGE ⁽²⁾		ORDERABLE PART NUMBER	TOP-SIDE MARKING
-40°C to 125°C	SOIC – D	Reel of 2500	TLE2142QDRQ1	2142Q

- (1) For the most current package and ordering information, see the Package Option Addendum at the end of this document, or see the TI web site at www.ti.com.
- (2) Package drawings, thermal data, and symbolization are available at www.ti.com/packaging.

EQUIVALENT SCHEMATIC

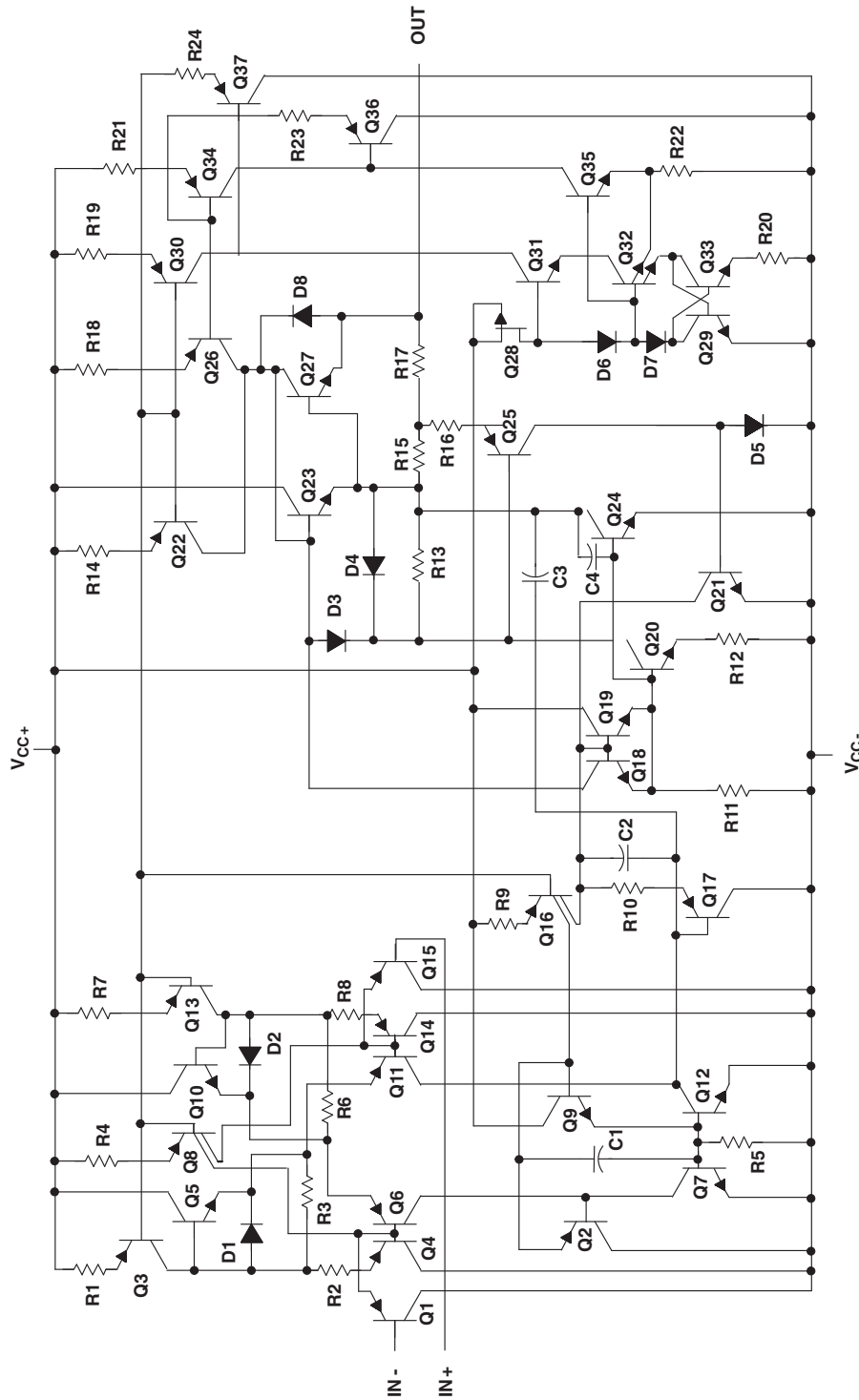

DEVICE COMPONENT COUNT

COMPONENT	TLE2142
Transistors	65
Resistors	43
Diodes	14
Capacitors	8
Epi-FET	1

ABSOLUTE MAXIMUM RATINGS⁽¹⁾

over operating free-air temperature range (unless otherwise noted)

V_{CC+}	Supply voltage ⁽²⁾	22 V
V_{CC-}	Supply voltage	-22 V
V_{ID}	Differential input voltage ⁽³⁾	±44 V
V_I	Input voltage range (any input)	V_{CC+} to $(V_{CC-} - 0.3)$ V
I_I	Input current (each input)	±1 mA
I_O	Output current	±80 mA
	Total current into V_{CC+}	80 mA
	Total current out of V_{CC-}	80 mA
	Duration of short-circuit current at (or below) 25°C ⁽⁴⁾	Unlimited
θ_{JA}	Package thermal impedance ⁽⁵⁾⁽⁶⁾	97.1°C/W
T_A	Operating free-air temperature range	-40°C to 125°C
T_{stg}	Storage temperature range	-65°C to 150°C
	Lead temperature 1,6 mm (1/16 inch) from case for 10 seconds	260°C
ESD	Electrostatic discharge rating, Human-body model	500 V

- (1) Stresses beyond those listed under "absolute maximum ratings" may cause permanent damage to the device. These are stress ratings only, and functional operation of the device at these or any other conditions beyond those indicated under "recommended operating conditions" is not implied. Exposure to absolute-maximum-rated conditions for extended periods may affect device reliability.
- (2) All voltage values, except differential voltages, are with respect to the midpoint between V_{CC+} and V_{CC-} .
- (3) Differential voltages are at IN+ with respect to IN-. Excessive current flows, if input, are brought below $V_{CC-} - 0.3$ V.
- (4) The output may be shorted to either supply. Temperature and/or supply voltages must be limited to ensure that the maximum dissipation rating is not exceeded.
- (5) Maximum power dissipation is a function of $T_J(\max)$, θ_{JA} , and T_A . The maximum allowable power dissipation at any allowable ambient temperature is $P_D = (T_J(\max) - T_A)/\theta_{JA}$. Operating at the absolute maximum T_J of 150°C can affect reliability.
- (6) The package thermal impedance is calculated in accordance with JESD 51-7.

RECOMMENDED OPERATING CONDITIONS

		MIN	MAX	UNIT	
$V_{CC\pm}$	Supply voltage	±2	±22	V	
V_{IC}	Common-mode input voltage	$V_{CC} = 5$ V	0	2.7	V
		$V_{CC\pm} = \pm 15$ V	-15	12.7	
T_A	Operating free-air temperature	-40	125	°C	

ELECTRICAL CHARACTERISTICS
 $V_{CC} = 5\text{ V}$, at specified free-air temperature (unless otherwise noted)

PARAMETER		TEST CONDITIONS	$T_A^{(1)}$	MIN	TYP	MAX	UNIT	
V_{IO}	Input offset voltage	$V_O = 2.5\text{ V}$, $R_S = 50\ \Omega$, $V_{IC} = 2.5\text{ V}$	25°C		220	1900	μV	
			Full range			2600		
α_{VIO}	Temperature coefficient of input offset voltage	$V_O = 2.5\text{ V}$, $R_S = 50\ \Omega$, $V_{IC} = 2.5\text{ V}$	Full range		1.7		$\mu\text{V}/^\circ\text{C}$	
I_{IO}	Input offset current	$V_O = 2.5\text{ V}$, $R_S = 50\ \Omega$, $V_{IC} = 2.5\text{ V}$	25°C		8	100	nA	
			Full range			200		
I_{IB}	Input bias current	$V_O = 2.5\text{ V}$, $R_S = 50\ \Omega$, $V_{IC} = 2.5\text{ V}$	25°C		-0.8	-2	μA	
			Full range			-2.3		
V_{ICR}	Common-mode input voltage range	$R_S = 50\ \Omega$	25°C	0 to 3	-0.3 to 3.2		V	
			Full range	0 to 2.7	-0.3 to 2.9			
V_{OH}	High-level output voltage		25°C	$I_{OH} = -150\ \mu\text{A}$	3.9	4.1	V	
				$I_{OH} = -1.5\text{ mA}$	3.8	4		
				$I_{OH} = -15\text{ mA}$	3.4	3.7		
			Full range	$I_{OH} = -100\ \mu\text{A}$	3.75			
				$I_{OH} = -1\text{ mA}$	3.65			
				$I_{OH} = -10\text{ mA}$	3.45			
V_{OL}	Low-level output voltage		25°C	$I_{OL} = 150\ \mu\text{A}$		75	125	mV
				$I_{OL} = 1.5\text{ mA}$		150	225	
				$I_{OL} = 15\text{ mA}$		1.2	1.4	
			Full range	$I_{OL} = 100\ \mu\text{A}$			200	mV
				$I_{OL} = 1\text{ mA}$			250	
				$I_{OL} = 10\text{ mA}$			1.25	
A_{VD}	Large-signal differential voltage amplification	$V_{IC} = \pm 2.5\text{ V}$, $R_L = 2\text{ k}\Omega$, $V_O = 1\text{ V to } -1.5\text{ V}$	25°C	50	220		V/mV	
			Full range	5				
r_i	Input resistance		25°C		70		M Ω	
c_i	Input capacitance		25°C		2.5		pF	
z_o	Open-loop output impedance	$f = 1\text{ MHz}$	25°C		30		Ω	
CMRR	Common-mode rejection ratio	$V_{IC} = V_{ICR}(\text{min})$, $R_S = 50\ \Omega$	25°C	85	118		dB	
			Full range	80				
k_{SVR}	Supply-voltage rejection ratio ($\Delta V_{CC\pm}/\Delta V_{IO}$)	$V_{CC\pm} = \pm 2.5\text{ V to } \pm 15\text{ V}$, $R_S = 50\ \Omega$	25°C	90	106		dB	
			Full range	85				
I_{CC}	Supply current	$V_O = 2.5\text{ V}$, No load, $V_{IC} = 2.5\text{ V}$	25°C		6.6	8.8	mA	
			Full range			9.2		

(1) Full range is -40°C to 125°C .

OPERATING CHARACTERISTICS

$V_{CC} = 5\text{ V}$, $T_A = 25^\circ\text{C}$ (unless otherwise noted)

PARAMETER		TEST CONDITIONS	MIN	TYP	MAX	UNIT
SR+	Positive slew rate	$A_{VD} = -1$, $R_L = 2\text{ k}\Omega^{(1)}$, $C_L = 500\text{ pF}$		45		$\text{V}/\mu\text{s}$
SR-	Negative slew rate	$A_{VD} = -1$, $R_L = 2\text{ k}\Omega^{(1)}$, $C_L = 500\text{ pF}$		42		$\text{V}/\mu\text{s}$
t_s	Settling time	$A_{VD} = -1$, 2.5-V step	To 0.1%	0.16		μs
			To 0.01%	0.22		
V_n	Equivalent input noise voltage	$R_S = 20\ \Omega$	$f = 10\text{ Hz}$	15		$\text{nV}/\sqrt{\text{Hz}}$
			$f = 1\text{ kHz}$	10.5		
$V_{n(PP)}$	Peak-to-peak equivalent input noise voltage	$f = 0.1\text{ Hz to }1\text{ Hz}$		0.48		μV
		$f = 0.1\text{ Hz to }10\text{ Hz}$		0.51		
I_n	Equivalent input noise current	$f = 10\text{ Hz}$		1.92		$\text{pA}/\sqrt{\text{Hz}}$
		$f = 1\text{ kHz}$		0.5		
THD+N	Total harmonic distortion plus noise	$V_O = 1\text{ V to }3\text{ V}$, $R_L = 2\text{ k}\Omega^{(1)}$, $A_{VD} = 2$, $f = 10\text{ kHz}$		0.0052		%
B_1	Unity-gain bandwidth	$R_L = 2\text{ k}\Omega^{(1)}$, $C_L = 100\text{ pF}$		5.9		MHz
	Gain-bandwidth product	$R_L = 2\text{ k}\Omega^{(1)}$, $C_L = 100\text{ pF}$, $f = 100\text{ kHz}$		5.8		MHz
BOM	Maximum output-swing bandwidth	$V_{O(PP)} = 2\text{ V}$, $R_L = 2\text{ k}\Omega^{(1)}$, $A_{VD} = 1$, $C_L = 100\text{ pF}$		660		kHz
ϕ_m	Phase margin at unity gain	$R_L = 2\text{ k}\Omega^{(1)}$, $C_L = 100\text{ pF}$		57		$^\circ$

(1) R_L terminated at 2.5 V.

ELECTRICAL CHARACTERISTICS
 $V_{CC} = \pm 15\text{ V}$, at specified free-air temperature (unless otherwise noted)

PARAMETER		TEST CONDITIONS		$T_A^{(1)}$	MIN	TYP	MAX	UNIT
V_{IO}	Input offset voltage	$V_{IC} = 0$, $R_S = 50\ \Omega$	25°C		290	1200	μV	
			Full range			2000		
α_{VIO}	Temperature coefficient of input offset voltage	$V_{IC} = 0$, $R_S = 50\ \Omega$	Full range		1.7		$\mu\text{V}/^\circ\text{C}$	
I_{IO}	Input offset current	$V_{IC} = 0$, $R_S = 50\ \Omega$	25°C		7	100	nA	
			Full range			250		
I_{IB}	Input bias current	$V_{IC} = 0$, $R_S = 50\ \Omega$	25°C		-0.7	-1.5	μA	
			Full range			-1.8		
V_{ICR}	Common-mode input voltage range	$R_S = 50\ \Omega$	25°C		-15 to 13	-15.3 to 13.2	V	
			Full range			-15 to 12.7		-15.3 to 12.9
V_{OM+}	Maximum positive peak output voltage swing		25°C	$I_O = -150\ \mu\text{A}$	13.8	14.1	V	
				$I_O = -1.5\ \text{mA}$	13.7	14		
				$I_O = -15\ \text{mA}$	13.3	13.7		
			Full range	$I_O = -100\ \mu\text{A}$	13.7			
				$I_O = -1\ \text{mA}$	13.6			
				$I_O = -10\ \text{mA}$	13.3			
V_{OM-}	Maximum negative peak output voltage swing		25°C	$I_O = 150\ \mu\text{A}$	-14.7	-14.9	V	
				$I_O = 1.5\ \text{mA}$	-14.5	-14.8		
				$I_O = 15\ \text{mA}$	-13.4	-13.8		
			Full range	$I_O = 100\ \mu\text{A}$	-14.6			
				$I_O = 1\ \text{mA}$	-14.5			
				$I_O = 10\ \text{mA}$	-13.4			
A_{VD}	Large-signal differential voltage amplification	$V_O = \pm 10\ \text{V}$, $R_L = 2\ \text{k}\Omega$	25°C		100	450	V/mV	
			Full range			20		
r_i	Input resistance		25°C		65		$\text{M}\Omega$	
c_i	Input capacitance		25°C		2.5		pF	
z_o	Open-loop output impedance	$f = 1\ \text{MHz}$	25°C		30		Ω	
CMRR	Common-mode rejection ratio	$V_{IC} = V_{ICR}(\text{min})$, $R_S = 50\ \Omega$	25°C		85	108	dB	
			Full range			80		
k_{SVR}	Supply-voltage rejection ratio ($\Delta V_{CC\pm}/\Delta V_{IO}$)	$V_{CC\pm} = \pm 2.5\ \text{V}$ to $\pm 15\ \text{V}$, $R_S = 50\ \Omega$	25°C		90	106	dB	
			Full range			85		
I_{OS}	Short-circuit output current	$V_O = 0$	$V_{ID} = 1\ \text{V}$	25°C	-25	-50	mA	
			$V_{ID} = -1\ \text{V}$		20	31		
I_{CC}	Supply current	$V_O = 0$, No load, $V_{IC} = 2.5\ \text{V}$	25°C		6.9	9	mA	
			Full range			9.4		

 (1) Full range is -40°C to 125°C .

OPERATING CHARACTERISTICS
 $V_{CC} = \pm 15\text{ V}$, $T_A = 25^\circ\text{C}$ (unless otherwise noted)

PARAMETER		TEST CONDITIONS	MIN	TYP	MAX	UNIT
SR+	Positive slew rate	$A_{VD} = -1$, $R_L = 2\text{ k}\Omega$, $C_L = 100\text{ pF}$	27	45		V/ μs
SR-	Negative slew rate	$A_{VD} = -1$, $R_L = 2\text{ k}\Omega$, $C_L = 100\text{ pF}$	27	42		V/ μs
t_s	Settling time	$A_{VD} = -1$, 10-V step	To 0.1%	0.34		μs
			To 0.01%	0.4		
V_n	Equivalent input noise voltage	$R_S = 20\ \Omega$	f = 10 Hz	15		nV/ $\sqrt{\text{Hz}}$
			f = 1 kHz	10.5		
$V_{n(PP)}$	Peak-to-peak equivalent input noise voltage	f = 0.1 Hz to 1 Hz		0.48		μV
		f = 0.1 Hz to 10 Hz		0.51		
I_n	Equivalent input noise current	f = 10 Hz		1.89		pA/ $\sqrt{\text{Hz}}$
		f = 1 kHz		0.47		
THD+N	Total harmonic distortion plus noise	$V_{O(PP)} = 20\text{ V}$, $R_L = 2\text{ k}\Omega$, $A_{VD} = 10$, f = 10 kHz		0.01		%
B_1	Unity-gain bandwidth	$R_L = 2\text{ k}\Omega$, $C_L = 100\text{ pF}$		6		MHz
	Gain-bandwidth product	$R_L = 2\text{ k}\Omega$, $C_L = 100\text{ pF}$, f = 100 kHz		5.9		MHz
BOM	Maximum output-swing bandwidth	$V_{O(PP)} = 20\text{ V}$, $A_{VD} = 1$, $R_L = 2\text{ k}\Omega$, $C_L = 100\text{ pF}$		668		kHz
ϕ_m	Phase margin at unity gain	$R_L = 2\text{ k}\Omega$, $C_L = 100\text{ pF}$		58		$^\circ$

TYPICAL CHARACTERISTICS

Table of Graphs

V_{IO}	Input offset voltage	Distribution	Figure 1
I_{IO}	Input offset current	vs Free-air temperature	Figure 2
I_{IB}	Input bias current	vs Common-mode input voltage	Figure 3
		vs Free-air temperature	Figure 4
V_{OM+}	Maximum positive peak output voltage	vs Supply voltage	Figure 5
		vs Free-air temperature	Figure 6
		vs Output current	Figure 7
		vs Settling time	Figure 9
V_{OM-}	Maximum negative peak output voltage	vs Supply voltage	Figure 5
		vs Free-air temperature	Figure 6
		vs Output current	Figure 8
		vs Settling time	Figure 9
$V_{O(PP)}$	Maximum peak-to-peak output voltage	vs Frequency	Figure 10
V_{OH}	High-level output voltage	vs Output current	Figure 11
V_{OL}	Low-level output voltage	vs Output current	Figure 12
	Phase shift	vs Frequency	Figure 13
A_{VD}	Large-signal differential voltage amplification	vs Frequency	Figure 13
		vs Free-air temperature	Figure 14
z_o	Closed-loop output impedance	vs Frequency	Figure 15
I_{OS}	Short-circuit output current	vs Free-air temperature	Figure 16
CMRR	Common-mode rejection ratio	vs Frequency	Figure 17
		vs Free-air temperature	Figure 18
k_{SVR}	Supply-voltage rejection ratio	vs Frequency	Figure 19
		vs Free-air temperature	Figure 20
I_{CC}	Supply current	vs Supply voltage	Figure 21
		vs Free-air temperature	Figure 22
V_n	Equivalent input noise voltage	vs Frequency	Figure 23
V_n	Input noise voltage	Over a 10-second period	Figure 24
I_n	Noise current	vs Frequency	Figure 25
THD+N	Total harmonic distortion plus noise	vs Frequency	Figure 26
SR	Slew rate	vs Free-air temperature	Figure 27
		vs Load capacitance	Figure 28
Pulse response	Noninverting large signal	vs Time	Figure 29
	Inverting large signal	vs Time	Figure 30
	Small signal	vs Time	Figure 31
B_1	Unity-gain bandwidth	vs Load capacitance	Figure 32
	Gain margin	vs Load capacitance	Figure 33
ϕ_m	Phase margin	vs Load capacitance	Figure 34

**TLE2142
DISTRIBUTION OF
INPUT OFFSET VOLTAGE**

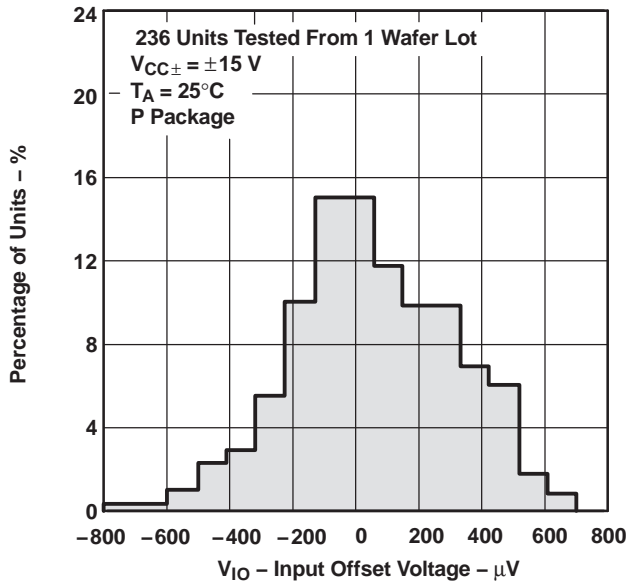

Figure 1.

**INPUT OFFSET CURRENT
vs
FREE-AIR TEMPERATURE**

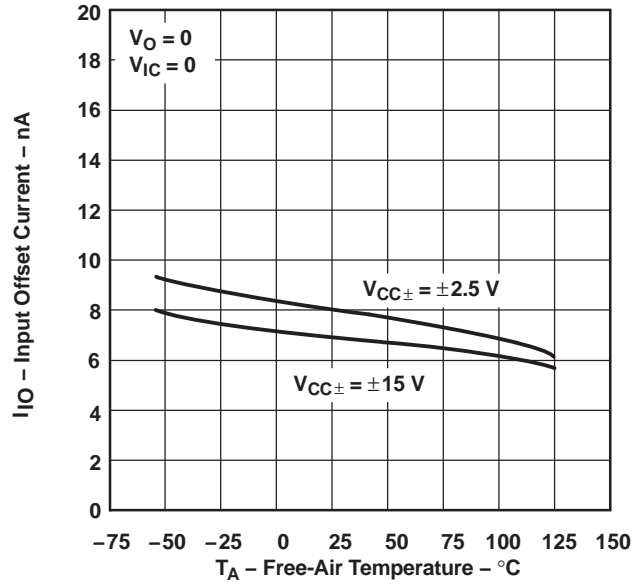

Figure 2.

**INPUT BIAS CURRENT
vs
COMMON-MODE INPUT VOLTAGE**

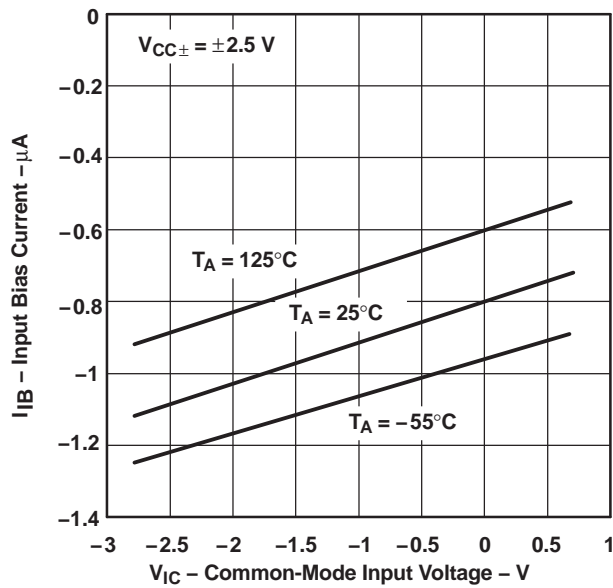

Figure 3.

**INPUT BIAS CURRENT
vs
FREE-AIR TEMPERATURE**

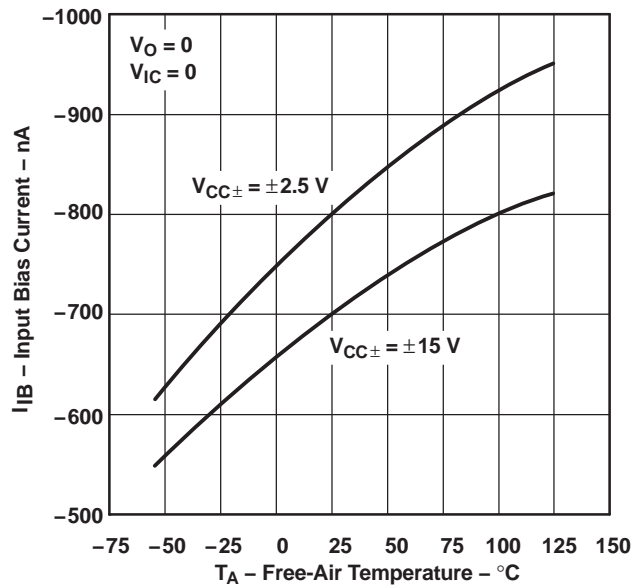
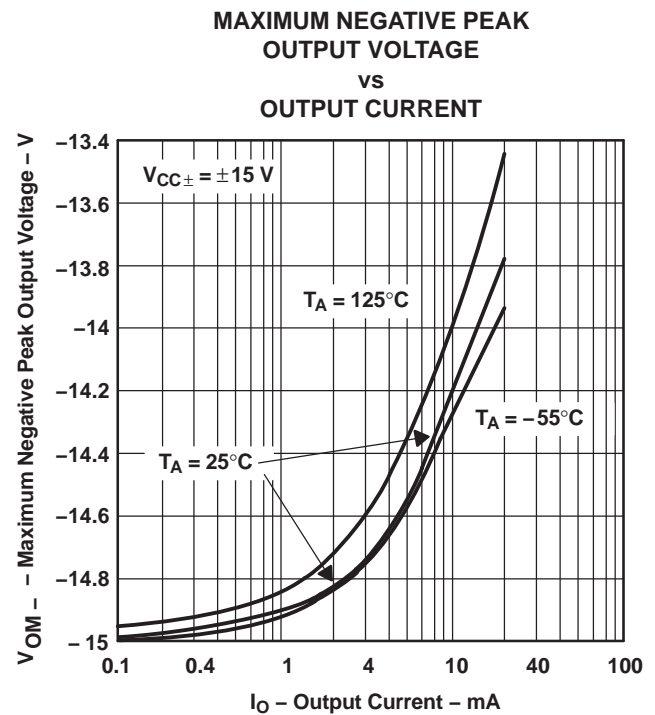
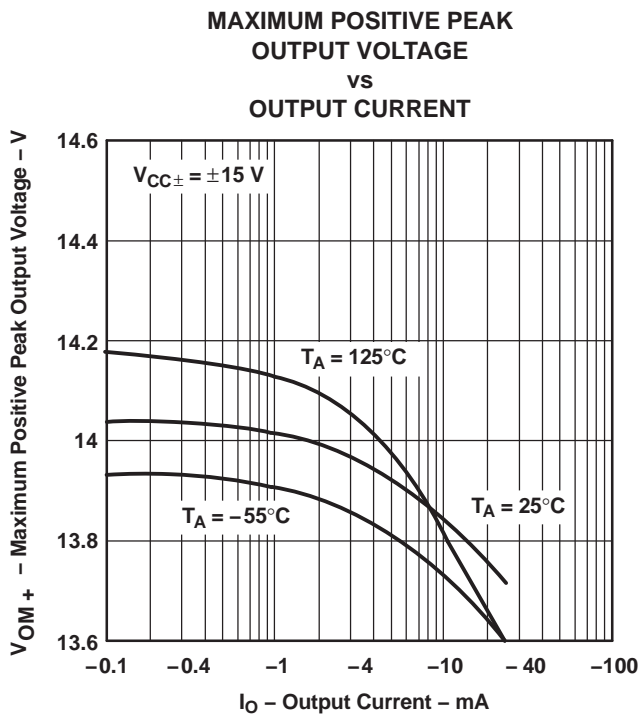
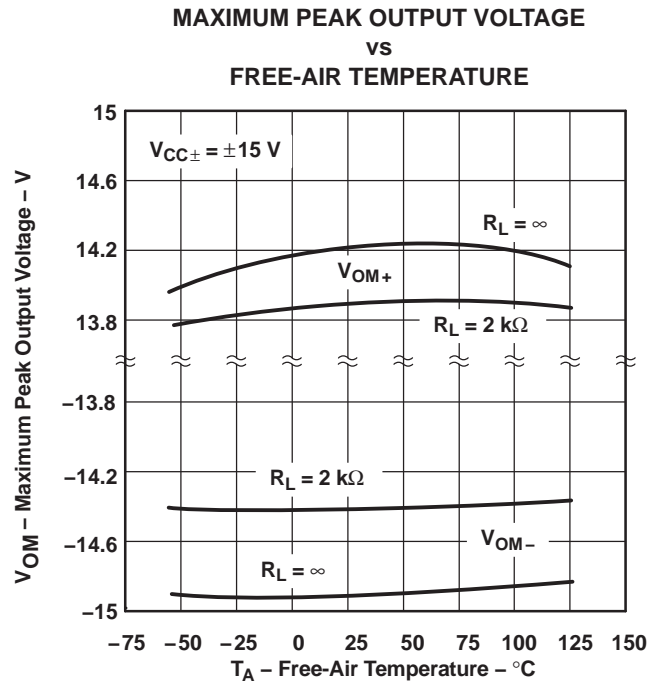
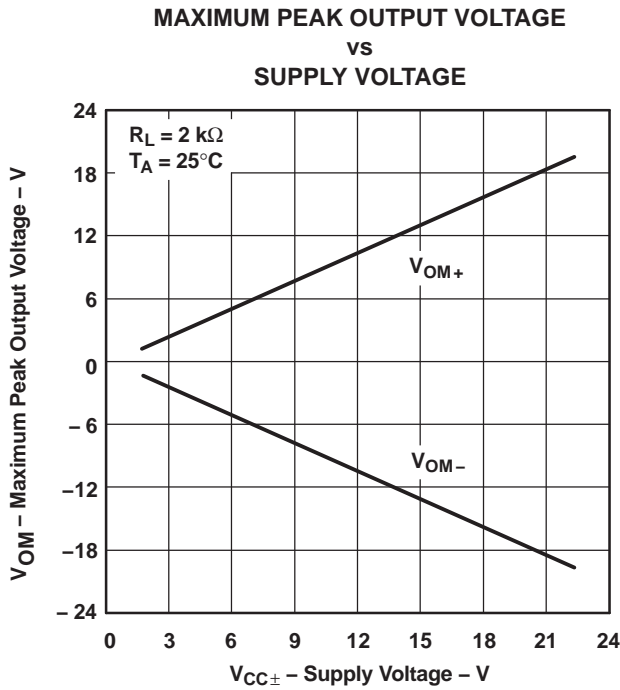

Figure 4.



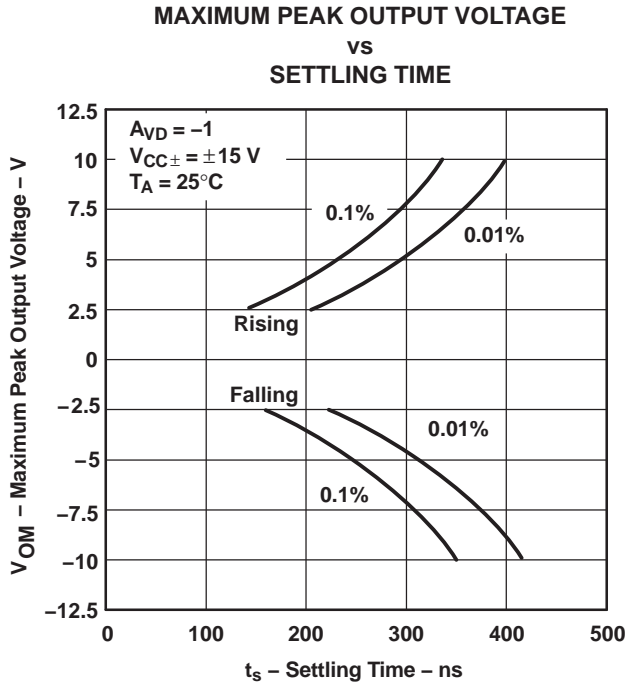

Figure 9.

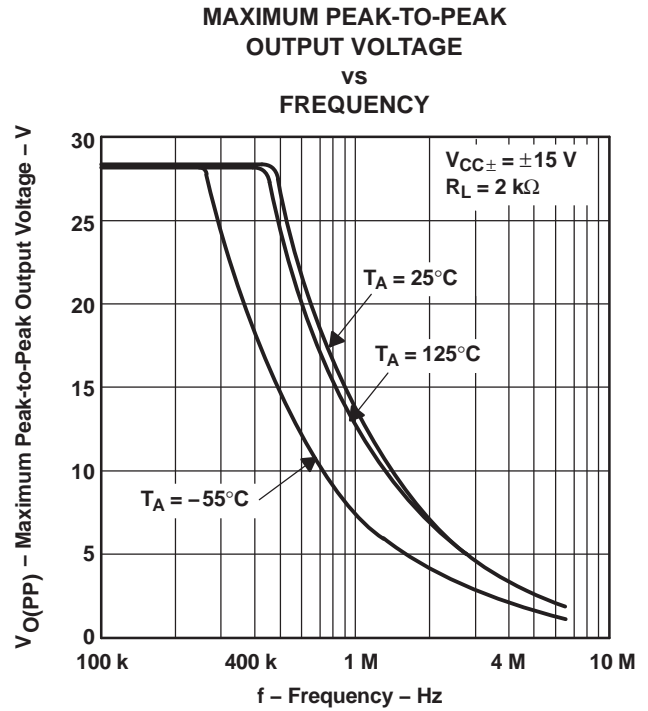

Figure 10.

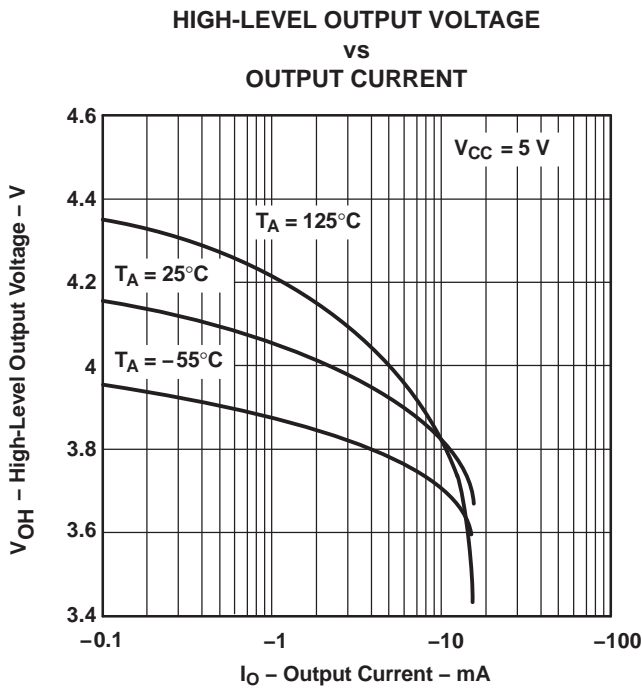

Figure 11.

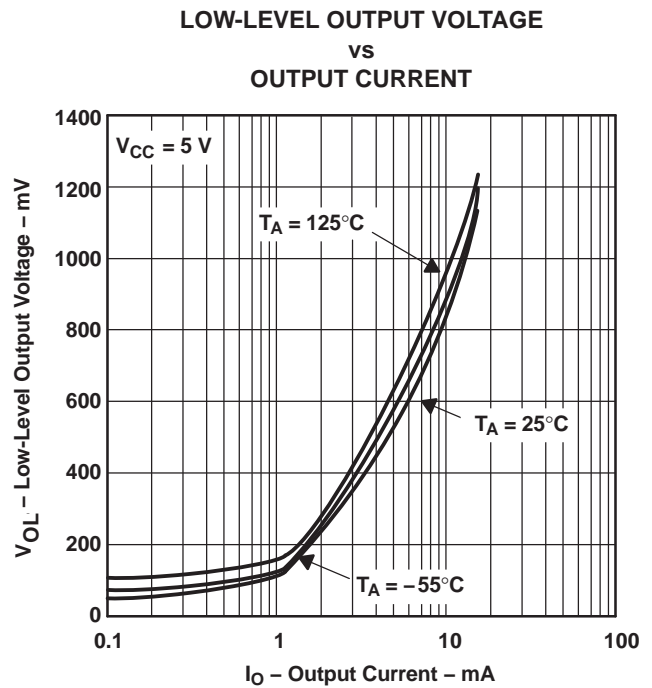

Figure 12.

LARGE-SIGNAL DIFFERENTIAL VOLTAGE AMPLIFICATION AND PHASE SHIFT VS FREQUENCY

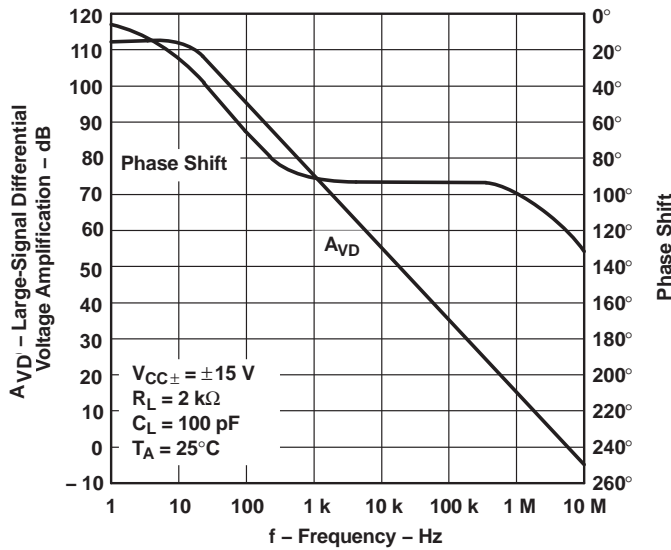

Figure 13.

LARGE-SIGNAL DIFFERENTIAL VOLTAGE AMPLIFICATION VS FREE-AIR TEMPERATURE

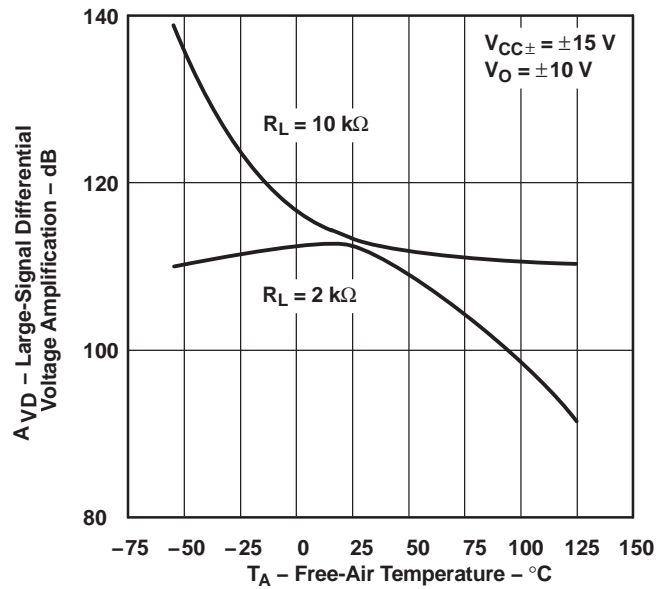

Figure 14.

CLOSED-LOOP OUTPUT IMPEDANCE VS FREQUENCY

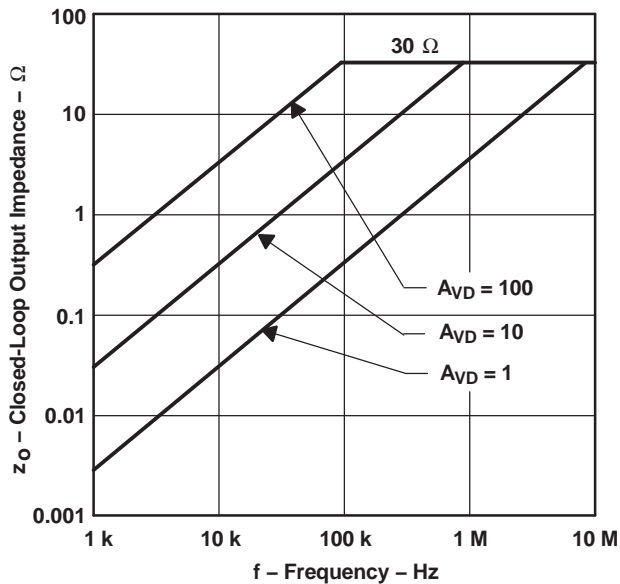

Figure 15.

SHORT-CIRCUIT OUTPUT CURRENT VS FREE-AIR TEMPERATURE

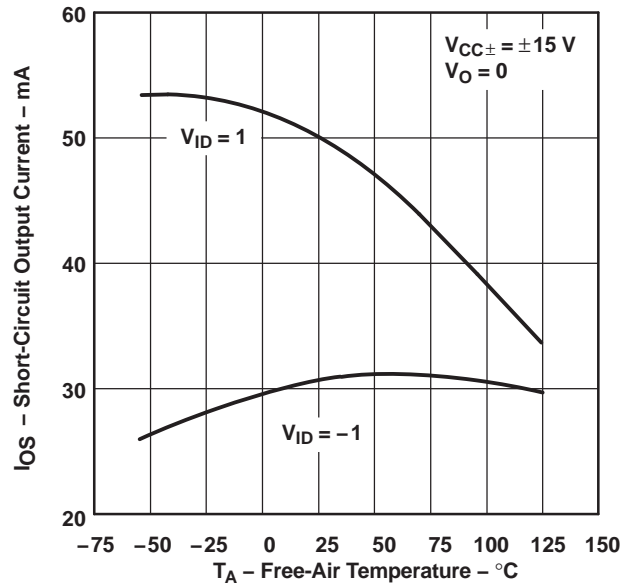

Figure 16.

COMMON-MODE REJECTION RATIO
vs
FREQUENCY

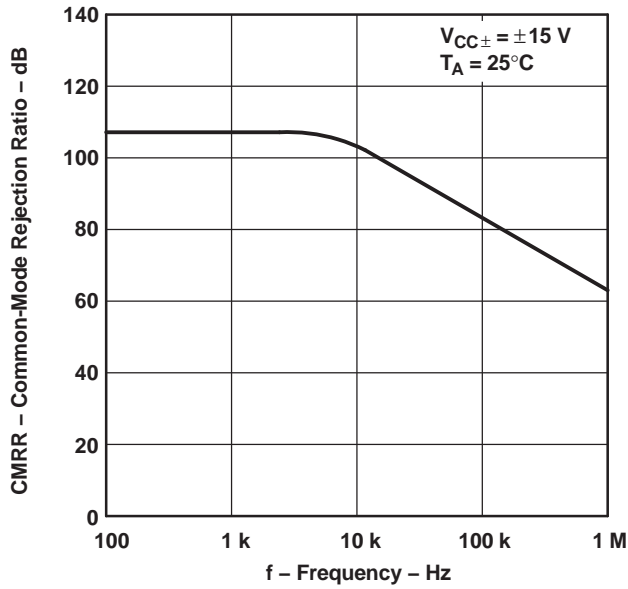

Figure 17.

COMMON-MODE REJECTION RATIO
vs
FREE-AIR TEMPERATURE

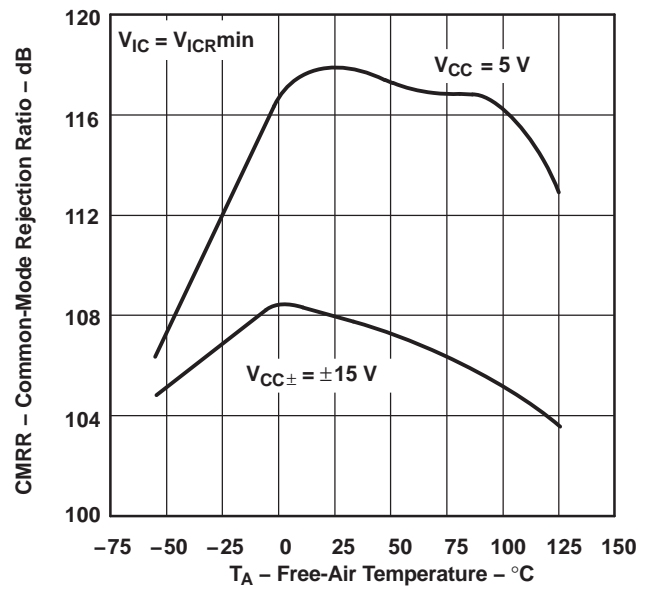

Figure 18.

SUPPLY-VOLTAGE REJECTION RATIO
vs
FREQUENCY

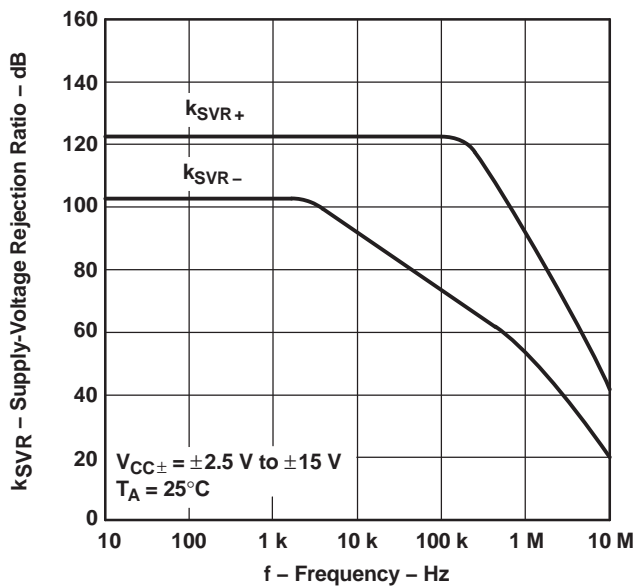

Figure 19.

SUPPLY-VOLTAGE REJECTION RATIO
vs
FREE-AIR TEMPERATURE

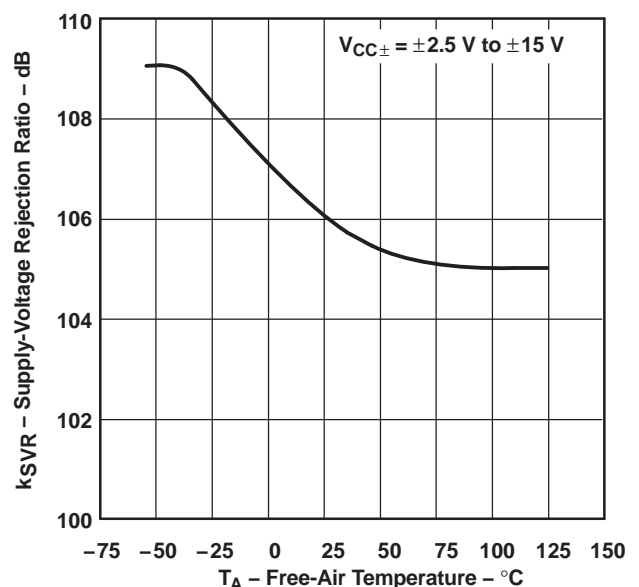

Figure 20.

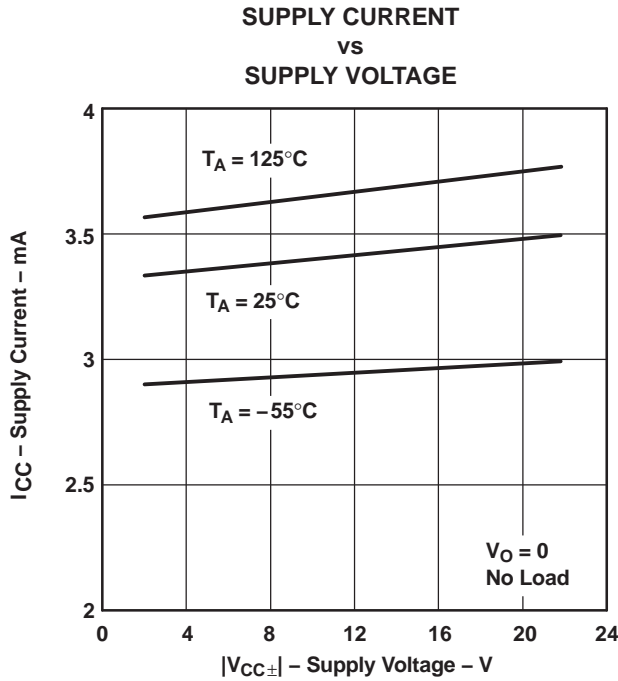

Figure 21.

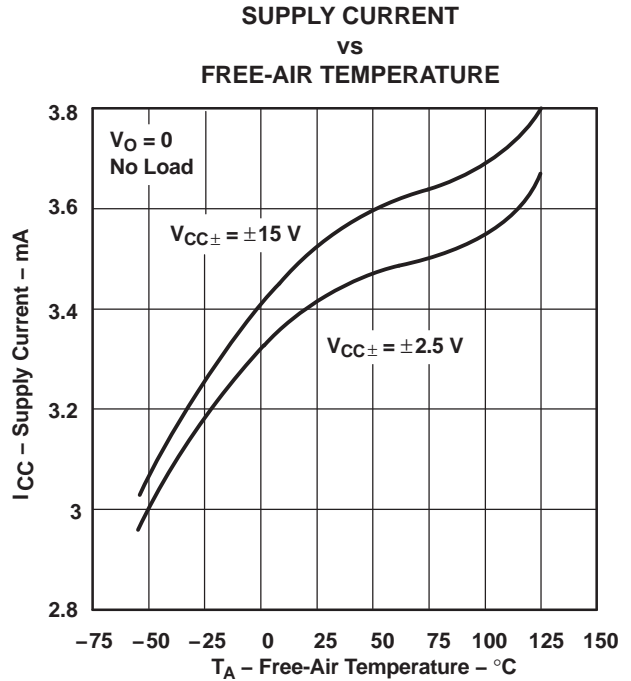

Figure 22.

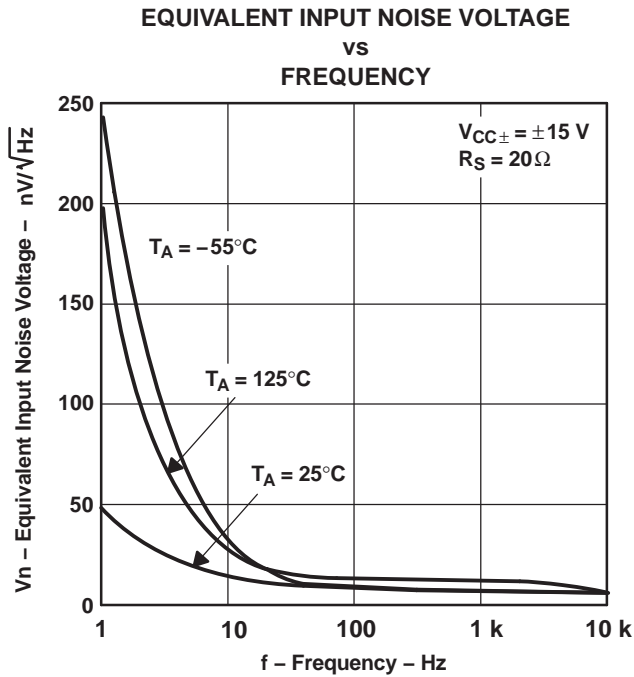

Figure 23.

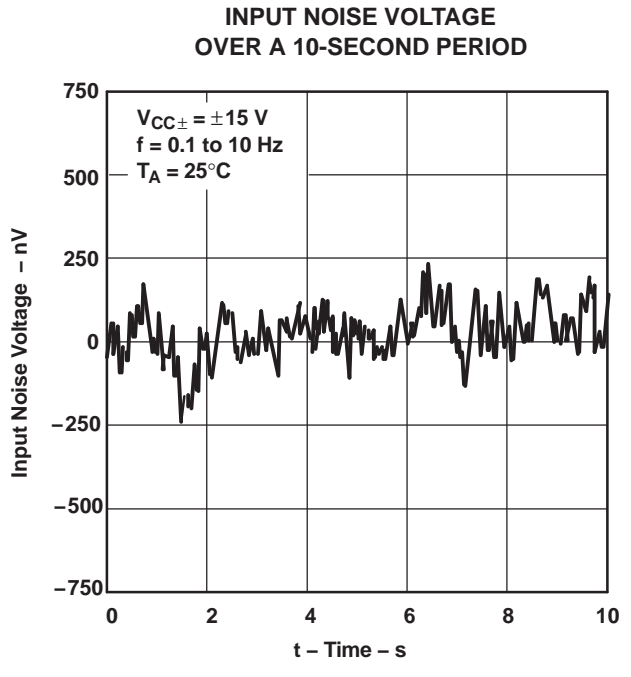

Figure 24.

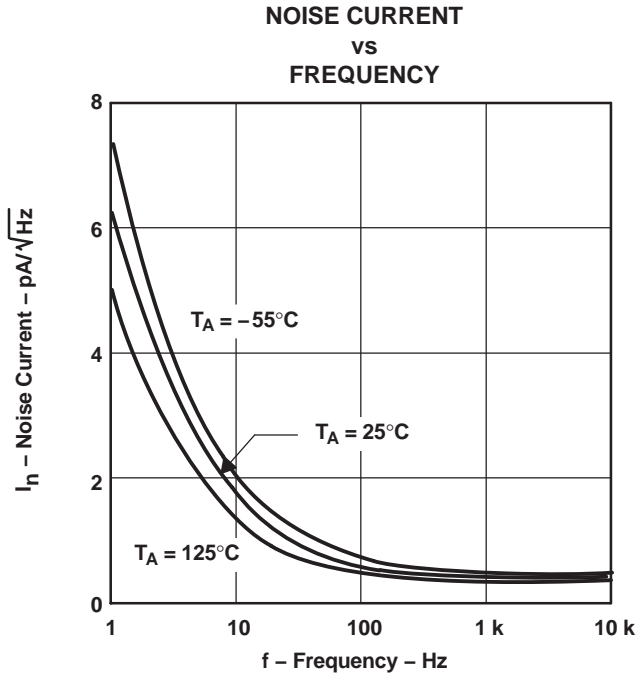

Figure 25.

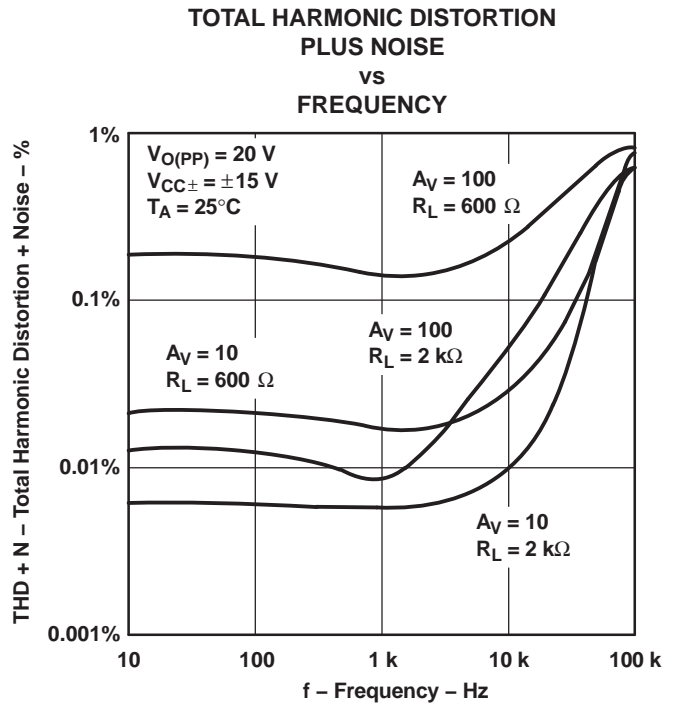

Figure 26.

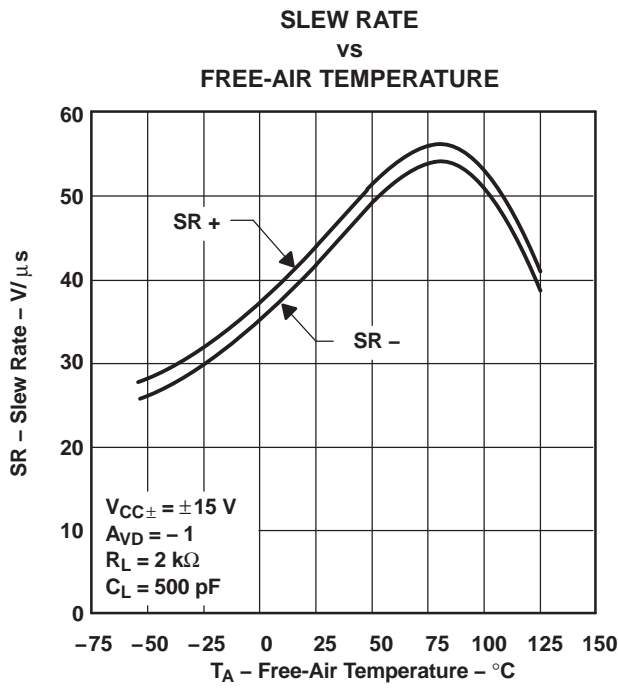

Figure 27.

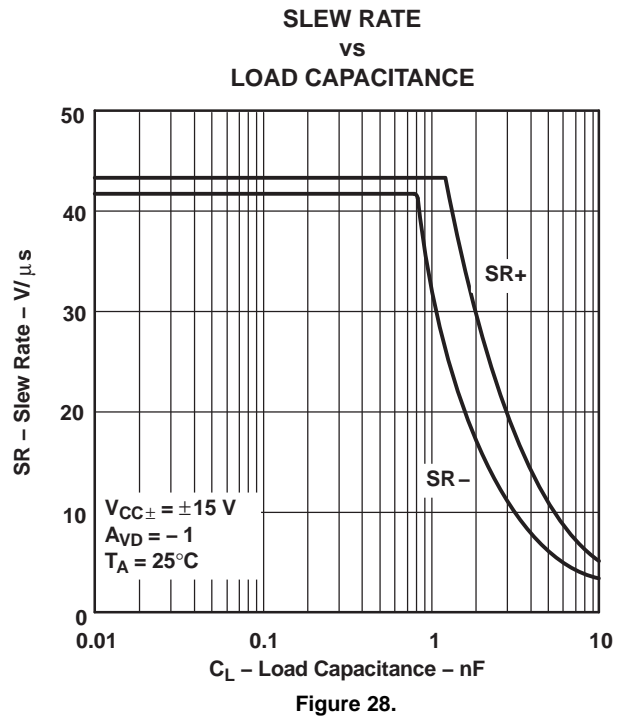

Figure 28.

**NONINVERTING
LARGE-SIGNAL
PULSE RESPONSE**

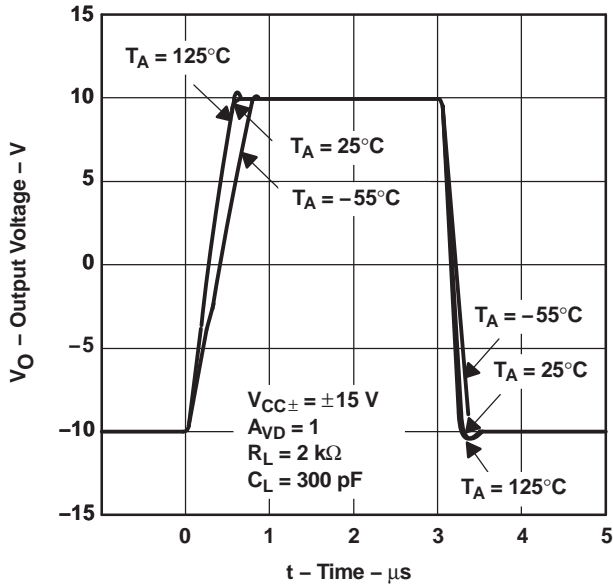

Figure 29.

**INVERTING
LARGE-SIGNAL
PULSE RESPONSE**

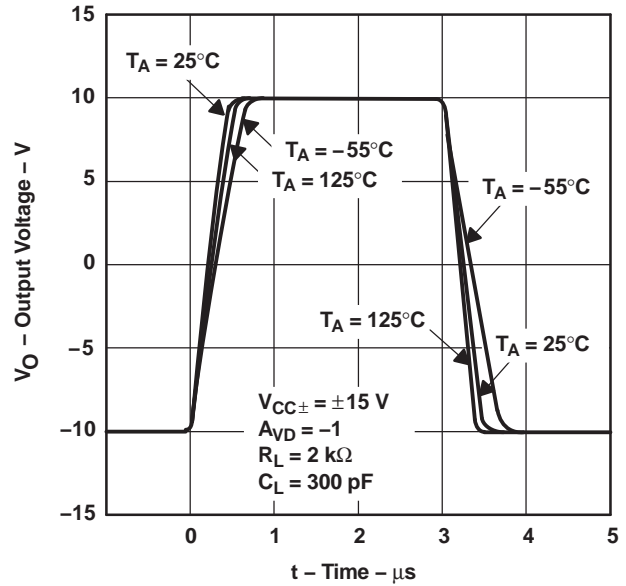

Figure 30.

**SMALL-SIGNAL
PULSE RESPONSE**

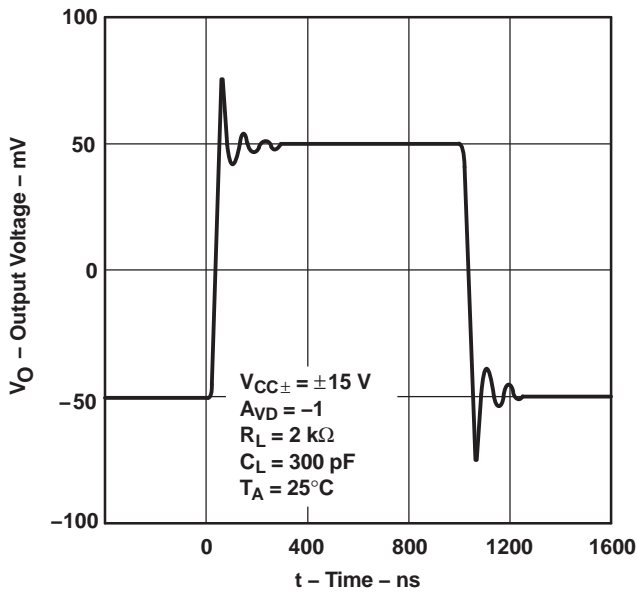

Figure 31.

**UNITY-GAIN BANDWIDTH
vs
LOAD CAPACITANCE**

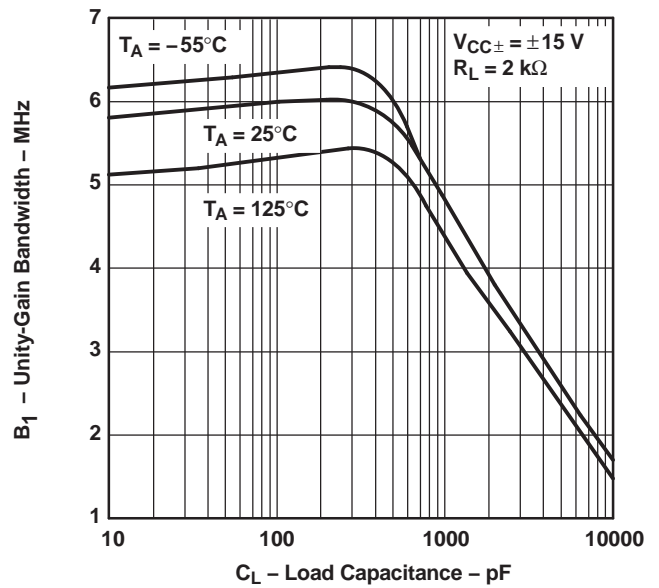
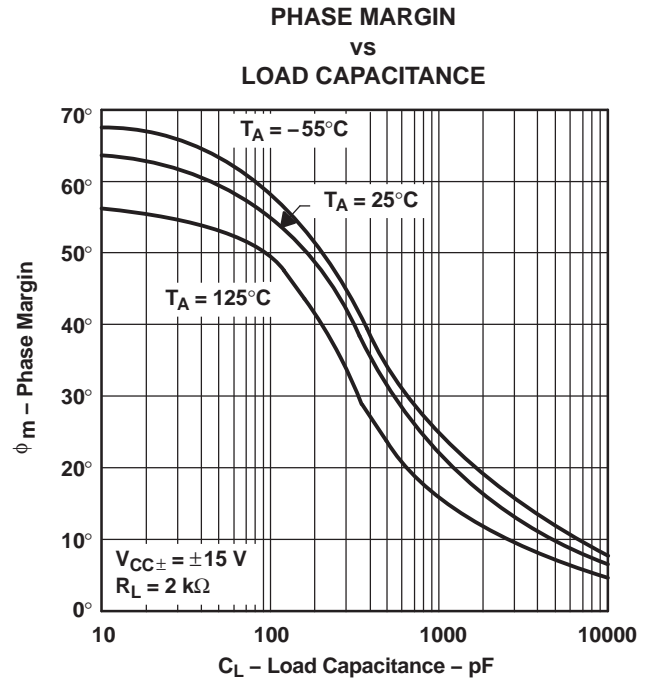
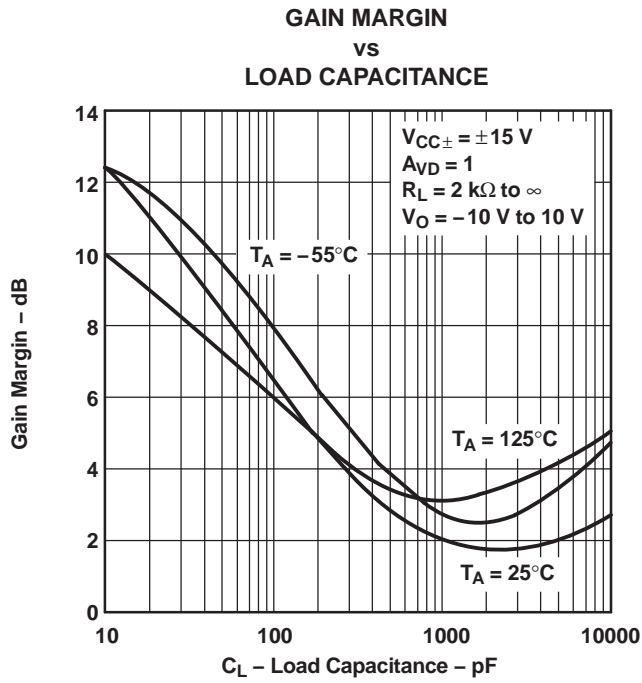

Figure 32.



PACKAGING INFORMATION

Orderable Device	Status ⁽¹⁾	Package Type	Package Drawing	Pins	Package Qty	Eco Plan ⁽²⁾	Lead/Ball Finish	MSL Peak Temp ⁽³⁾
TLE2142QDRQ1	ACTIVE	SOIC	D	8	2500	Green (RoHS & no Sb/Br)	CU NIPDAU	Level-1-260C-UNLIM

⁽¹⁾ The marketing status values are defined as follows:

ACTIVE: Product device recommended for new designs.

LIFEBUY: TI has announced that the device will be discontinued, and a lifetime-buy period is in effect.

NRND: Not recommended for new designs. Device is in production to support existing customers, but TI does not recommend using this part in a new design.

PREVIEW: Device has been announced but is not in production. Samples may or may not be available.

OBSELETE: TI has discontinued the production of the device.

⁽²⁾ Eco Plan - The planned eco-friendly classification: Pb-Free (RoHS), Pb-Free (RoHS Exempt), or Green (RoHS & no Sb/Br) - please check <http://www.ti.com/productcontent> for the latest availability information and additional product content details.

TBD: The Pb-Free/Green conversion plan has not been defined.

Pb-Free (RoHS): TI's terms "Lead-Free" or "Pb-Free" mean semiconductor products that are compatible with the current RoHS requirements for all 6 substances, including the requirement that lead not exceed 0.1% by weight in homogeneous materials. Where designed to be soldered at high temperatures, TI Pb-Free products are suitable for use in specified lead-free processes.

Pb-Free (RoHS Exempt): This component has a RoHS exemption for either 1) lead-based flip-chip solder bumps used between the die and package, or 2) lead-based die adhesive used between the die and leadframe. The component is otherwise considered Pb-Free (RoHS compatible) as defined above.

Green (RoHS & no Sb/Br): TI defines "Green" to mean Pb-Free (RoHS compatible), and free of Bromine (Br) and Antimony (Sb) based flame retardants (Br or Sb do not exceed 0.1% by weight in homogeneous material)

⁽³⁾ MSL, Peak Temp. -- The Moisture Sensitivity Level rating according to the JEDEC industry standard classifications, and peak solder temperature.

Important Information and Disclaimer:The information provided on this page represents TI's knowledge and belief as of the date that it is provided. TI bases its knowledge and belief on information provided by third parties, and makes no representation or warranty as to the accuracy of such information. Efforts are underway to better integrate information from third parties. TI has taken and continues to take reasonable steps to provide representative and accurate information but may not have conducted destructive testing or chemical analysis on incoming materials and chemicals. TI and TI suppliers consider certain information to be proprietary, and thus CAS numbers and other limited information may not be available for release.

In no event shall TI's liability arising out of such information exceed the total purchase price of the TI part(s) at issue in this document sold by TI to Customer on an annual basis.

OTHER QUALIFIED VERSIONS OF TLE2142-Q1 :

- Catalog: [TLE2142](#)
- Military: [TLE2142M](#)

NOTE: Qualified Version Definitions:

- Catalog - TI's standard catalog product
- Military - QML certified for Military and Defense Applications

TAPE AND REEL INFORMATION

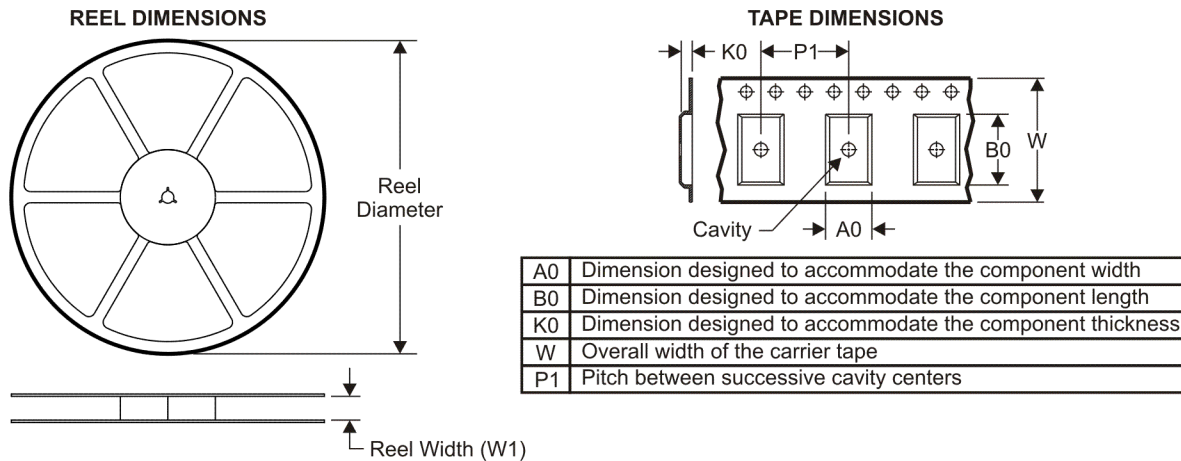

QUADRANT ASSIGNMENTS FOR PIN 1 ORIENTATION IN TAPE

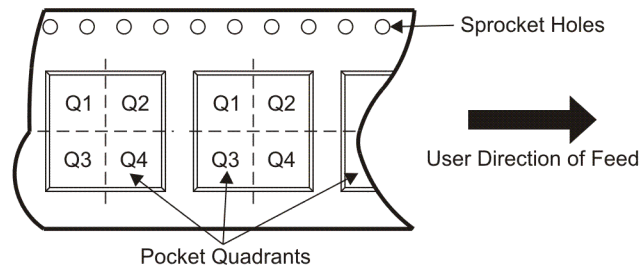

*All dimensions are nominal

Device	Package Type	Package Drawing	Pins	SPQ	Reel Diameter (mm)	Reel Width W1 (mm)	A0 (mm)	B0 (mm)	K0 (mm)	P1 (mm)	W (mm)	Pin1 Quadrant
TLE2142QDRQ1	SOIC	D	8	2500	330.0	12.4	6.4	5.2	2.1	8.0	12.0	Q1

TAPE AND REEL BOX DIMENSIONS



*All dimensions are nominal

Device	Package Type	Package Drawing	Pins	SPQ	Length (mm)	Width (mm)	Height (mm)
TLE2142QDRQ1	SOIC	D	8	2500	340.5	338.1	20.6

D (R-PDSO-G8)

PLASTIC SMALL OUTLINE

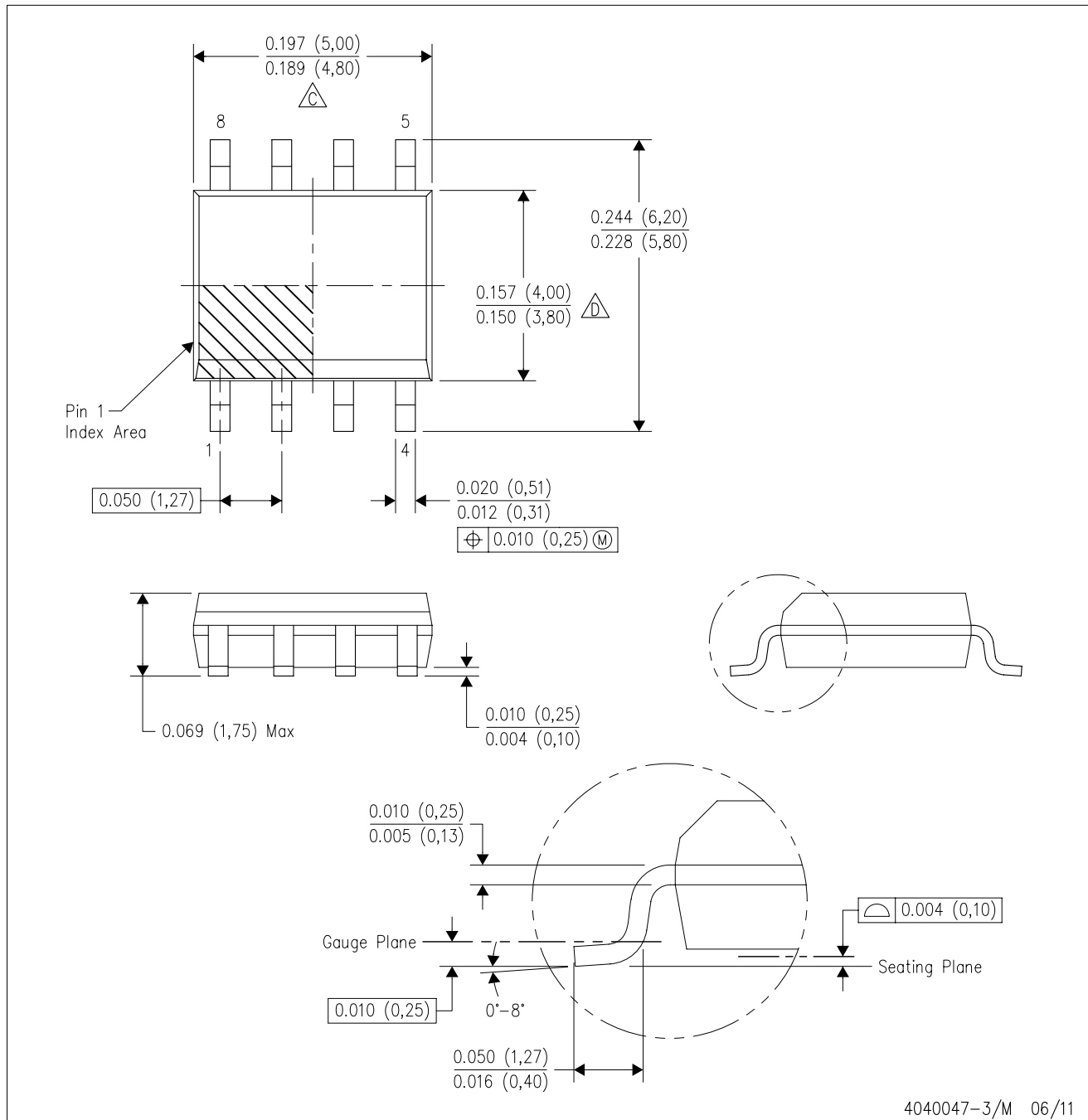

- NOTES:
- A. All linear dimensions are in inches (millimeters).
 - B. This drawing is subject to change without notice.
 - C. Body length does not include mold flash, protrusions, or gate burrs. Mold flash, protrusions, or gate burrs shall not exceed 0.006 (0,15) each side.
 - D. Body width does not include interlead flash. Interlead flash shall not exceed 0.017 (0,43) each side.
 - E. Reference JEDEC MS-012 variation AA.

IMPORTANT NOTICE

Texas Instruments Incorporated and its subsidiaries (TI) reserve the right to make corrections, modifications, enhancements, improvements, and other changes to its products and services at any time and to discontinue any product or service without notice. Customers should obtain the latest relevant information before placing orders and should verify that such information is current and complete. All products are sold subject to TI's terms and conditions of sale supplied at the time of order acknowledgment.

TI warrants performance of its hardware products to the specifications applicable at the time of sale in accordance with TI's standard warranty. Testing and other quality control techniques are used to the extent TI deems necessary to support this warranty. Except where mandated by government requirements, testing of all parameters of each product is not necessarily performed.

TI assumes no liability for applications assistance or customer product design. Customers are responsible for their products and applications using TI components. To minimize the risks associated with customer products and applications, customers should provide adequate design and operating safeguards.

TI does not warrant or represent that any license, either express or implied, is granted under any TI patent right, copyright, mask work right, or other TI intellectual property right relating to any combination, machine, or process in which TI products or services are used. Information published by TI regarding third-party products or services does not constitute a license from TI to use such products or services or a warranty or endorsement thereof. Use of such information may require a license from a third party under the patents or other intellectual property of the third party, or a license from TI under the patents or other intellectual property of TI.

Reproduction of TI information in TI data books or data sheets is permissible only if reproduction is without alteration and is accompanied by all associated warranties, conditions, limitations, and notices. Reproduction of this information with alteration is an unfair and deceptive business practice. TI is not responsible or liable for such altered documentation. Information of third parties may be subject to additional restrictions.

Resale of TI products or services with statements different from or beyond the parameters stated by TI for that product or service voids all express and any implied warranties for the associated TI product or service and is an unfair and deceptive business practice. TI is not responsible or liable for any such statements.

TI products are not authorized for use in safety-critical applications (such as life support) where a failure of the TI product would reasonably be expected to cause severe personal injury or death, unless officers of the parties have executed an agreement specifically governing such use. Buyers represent that they have all necessary expertise in the safety and regulatory ramifications of their applications, and acknowledge and agree that they are solely responsible for all legal, regulatory and safety-related requirements concerning their products and any use of TI products in such safety-critical applications, notwithstanding any applications-related information or support that may be provided by TI. Further, Buyers must fully indemnify TI and its representatives against any damages arising out of the use of TI products in such safety-critical applications.

TI products are neither designed nor intended for use in military/aerospace applications or environments unless the TI products are specifically designated by TI as military-grade or "enhanced plastic." Only products designated by TI as military-grade meet military specifications. Buyers acknowledge and agree that any such use of TI products which TI has not designated as military-grade is solely at the Buyer's risk, and that they are solely responsible for compliance with all legal and regulatory requirements in connection with such use.

TI products are neither designed nor intended for use in automotive applications or environments unless the specific TI products are designated by TI as compliant with ISO/TS 16949 requirements. Buyers acknowledge and agree that, if they use any non-designated products in automotive applications, TI will not be responsible for any failure to meet such requirements.

Following are URLs where you can obtain information on other Texas Instruments products and application solutions:

Products

Audio	www.ti.com/audio
Amplifiers	amplifier.ti.com
Data Converters	dataconverter.ti.com
DLP® Products	www.dlp.com
DSP	dsp.ti.com
Clocks and Timers	www.ti.com/clocks
Interface	interface.ti.com
Logic	logic.ti.com
Power Mgmt	power.ti.com
Microcontrollers	microcontroller.ti.com
RFID	www.ti-rfid.com
RF/IF and ZigBee® Solutions	www.ti.com/lprf

Applications

Communications and Telecom	www.ti.com/communications
Computers and Peripherals	www.ti.com/computers
Consumer Electronics	www.ti.com/consumer-apps
Energy and Lighting	www.ti.com/energy
Industrial	www.ti.com/industrial
Medical	www.ti.com/medical
Security	www.ti.com/security
Space, Avionics and Defense	www.ti.com/space-avionics-defense
Transportation and Automotive	www.ti.com/automotive
Video and Imaging	www.ti.com/video
Wireless	www.ti.com/wireless-apps

TI E2E Community Home Page

e2e.ti.com

Mailing Address: Texas Instruments, Post Office Box 655303, Dallas, Texas 75265
Copyright © 2011, Texas Instruments Incorporated