

# N-Channel NexFET™ Power MOSFET

Check for Samples: [CSD13303W1015](#)

## FEATURES

- Ultra Low on Resistance
- Ultra Low Qg and Qgd
- Small Footprint
- Low Profile 0.62 mm Height
- Pb Free
- RoHS Compliant
- Halogen Free
- CSP 1 × 1.5 mm Wafer Level Package

## APPLICATIONS

- Battery Management
- Load Switch
- Battery Protection

## DESCRIPTION

The device has been designed to deliver the lowest on resistance and gate charge in the smallest outline possible with excellent thermal characteristics in an ultra low profile.

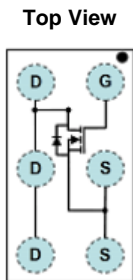

## PRODUCT SUMMARY

T <sub>A</sub> = 25°C unless otherwise stated		TYPICAL VALUE	UNIT
V <sub>DS</sub>	Drain to Source Voltage	12	V
Q <sub>g</sub>	Gate Charge Total (4.5V)	3.9	nC
Q <sub>gd</sub>	Gate Charge Gate to Drain	0.4	nC
R <sub>DS(on)</sub>	Drain to Source On Resistance	V <sub>GS</sub> = 2.5V	18 mΩ
		V <sub>GS</sub> = 4.5V	16 mΩ
V <sub>GS(th)</sub>	Voltage Threshold	0.85	V

## ORDERING INFORMATION

Device	Package	Media	Qty	Ship
CSD13303W1015	1 × 1.5 Wafer Level Package	7-inch reel	3000	Tape and Reel

## ABSOLUTE MAXIMUM RATINGS

T <sub>A</sub> = 25°C unless otherwise stated		VALUE	UNIT
V <sub>DS</sub>	Drain to Source Voltage	12	V
V <sub>GS</sub>	Gate to Source Voltage	±8	V
I <sub>D</sub>	Continuous Drain Current, T <sub>C</sub> = 25°C <sup>(1)</sup>	3.5	A
I <sub>DM</sub>	Pulsed Drain Current, T <sub>A</sub> = 25°C <sup>(2)</sup>	31	A
P <sub>D</sub>	Power Dissipation <sup>(1)</sup>	1.65	W
T <sub>STG</sub>	Storage Temperature Range	-55 to 150	°C
T <sub>J</sub>	Operating Junction Temperature Range		

(1) Typical R<sub>θJA</sub> = 75.7°C/W on 1in<sup>2</sup> Cu (2 oz.) on 0.060" thick FR4 PCB.

(2) Pulse width ≤1ms, duty cycle ≤2%

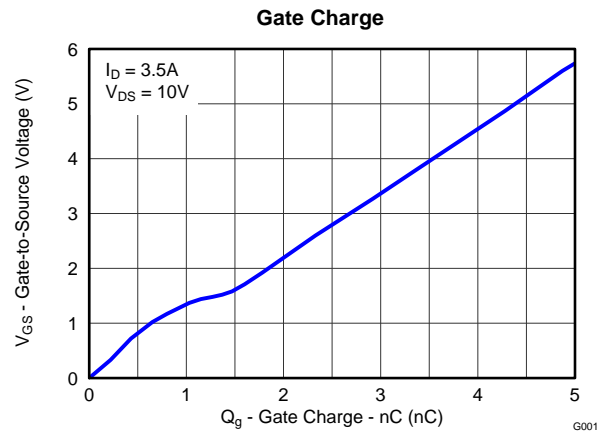
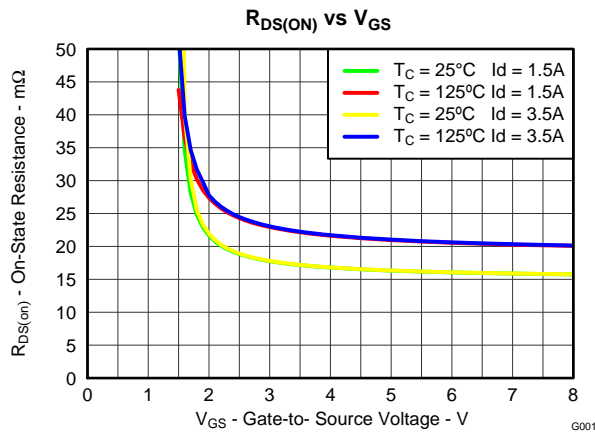

Please be aware that an important notice concerning availability, standard warranty, and use in critical applications of Texas Instruments semiconductor products and disclaimers thereto appears at the end of this data sheet.



These devices have limited built-in ESD protection. The leads should be shorted together or the device placed in conductive foam during storage or handling to prevent electrostatic damage to the MOS gates.

## ELECTRICAL CHARACTERISTICS

( $T_A = 25^\circ\text{C}$  unless otherwise stated)

PARAMETER		TEST CONDITIONS	MIN	TYP	MAX	UNIT
<b>Static Characteristics</b>						
$BV_{DSS}$	Drain to Source Voltage	$V_{GS} = 0V, I_D = 250\mu A$	12			V
$I_{DSS}$	Drain to Source Leakage Current	$V_{GS} = 0V, V_{DS} = 9.6V$			1	$\mu A$
$I_{GSS}$	Gate to Source Leakage Current	$V_{DS} = 0V, V_{GS} = +8V$			100	nA
$V_{GS(th)}$	Gate to Source Threshold Voltage	$V_{DS} = V_{GS}, I_D = 250\mu A$	0.65	0.85	1.2	V
$R_{DS(on)}$	Drain to Source On Resistance	$V_{GS} = 2.5V, I_D = 1.5A$		18	23	$m\Omega$
		$V_{GS} = 4.5V, I_D = 1.5A$		16	20	$m\Omega$
$g_{fs}$	Transconductance	$V_{DS} = 6V, I_D = 1.5A$		14		S
<b>Dynamic Characteristics</b>						
$C_{ISS}$	Input Capacitance	$V_{GS} = 0V, V_{DS} = 6V, f = 1MHz$		550	715	pF
$C_{OSS}$	Output Capacitance			400	480	pF
$C_{RSS}$	Reverse Transfer Capacitance			29	36	pF
$R_g$	Gate Charge Total (4.5V)	$V_{DS} = 6V, I_D = 1.5A$		3	4.6	$\Omega$
$Q_g$	Gate Charge Total (4.5V)			3.9	4.7	nC
$Q_{gd}$	Gate Charge Gate to Drain			0.4		nC
$Q_{gs}$	Gate Charge Gate to Source			1		nC
$Q_{g(th)}$	Gate Charge at $V_{th}$			0.6		nC
$Q_{OSS}$	Output Charge	$V_{DS} = 6V, V_{GS} = 0V$		4.9		nC
$t_{d(on)}$	Turn On Delay Time	$V_{DS} = 6V, V_{GS} = 4.5V, I_D = 1.5A$ $R_G = 4\Omega$		4.6		ns
$t_r$	Rise Time			10		ns
$t_{d(off)}$	Turn Off Delay Time			14.7		ns
$t_f$	Fall Time			3.2		ns
<b>Diode Characteristics</b>						
$V_{SD}$	Diode Forward Voltage	$I_S = 1.5A, V_{GS} = 0V$		0.7	1	V
$Q_{rr}$	Reverse Recovery Charge	$V_{DS} = 6V, I_F = 1.5A, di/dt = 200A/\mu s$		14		nC
$t_{rr}$	Reverse Recovery Time			38.7		ns

## THERMAL CHARACTERISTICS

( $T_A = 25^\circ\text{C}$  unless otherwise stated)

PARAMETER		MIN	TYP	MAX	UNIT
$R_{\theta JA}$	Thermal Resistance Junction to Ambient (Minimum Cu area)			295.5	$^\circ\text{C/W}$
	Thermal Resistance Junction to Ambient (1 in <sup>2</sup> Cu area)			94.6	$^\circ\text{C/W}$

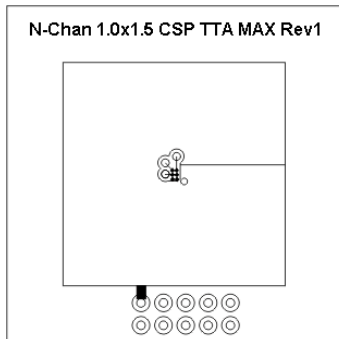

Max  $R_{\theta JA} = 94.6^{\circ}\text{C/W}$   
when mounted on 1  
 $\text{inch}^2$  of 2 oz. Cu.

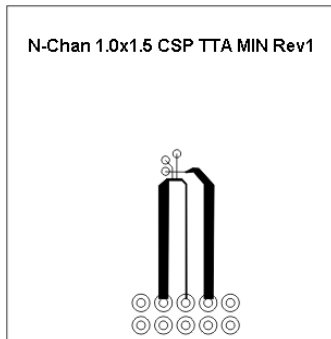

Max  $R_{\theta JA} = 295.5^{\circ}\text{C/W}$   
when mounted on  
minimum pad area of 2  
oz. Cu.

### TYPICAL MOSFET CHARACTERISTICS

( $T_A = 25^{\circ}\text{C}$  unless otherwise stated)

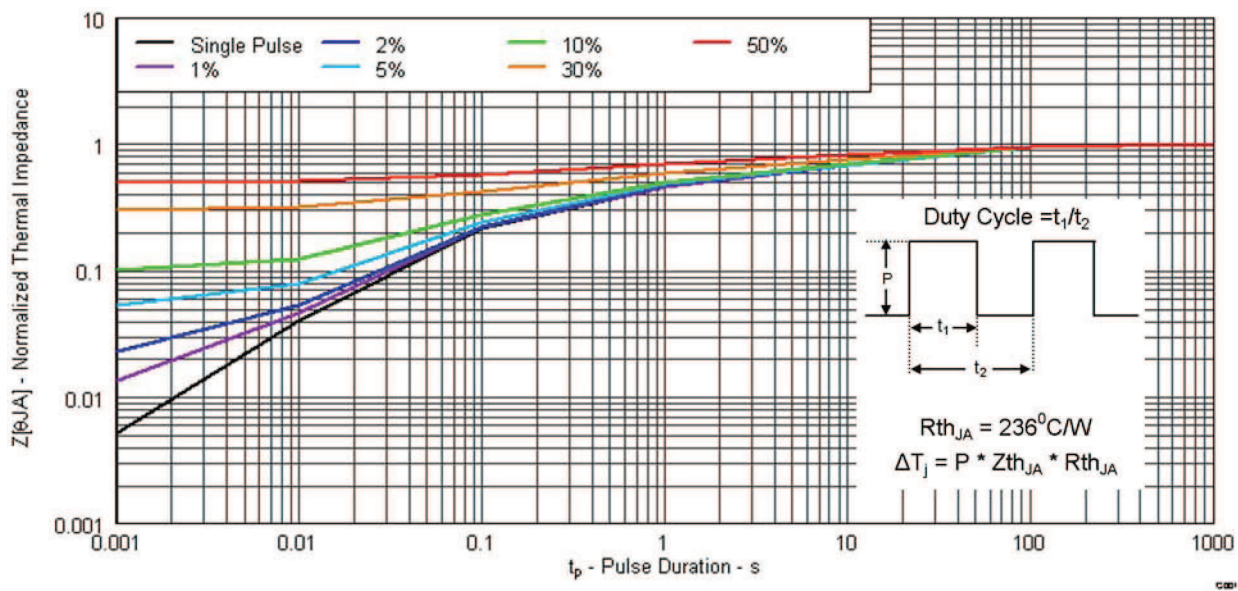
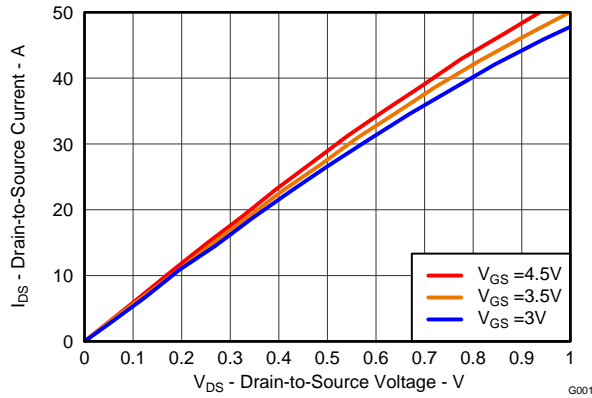

Figure 1. Transient Thermal Impedance

**TYPICAL MOSFET CHARACTERISTICS (continued)**

( $T_A = 25^\circ\text{C}$  unless otherwise stated)



**Figure 2. Saturation Characteristics**

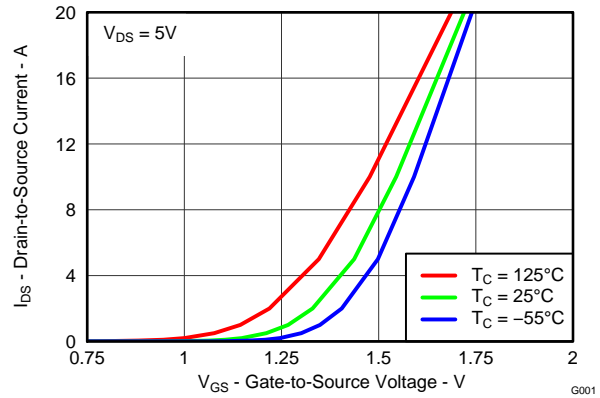

**Figure 3. Transfer Characteristics**

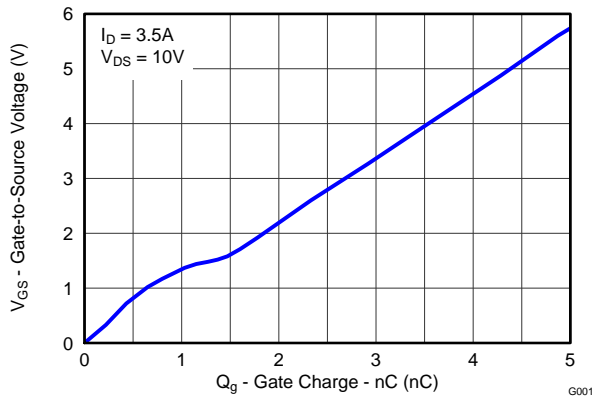

**Figure 4. Gate Charge**

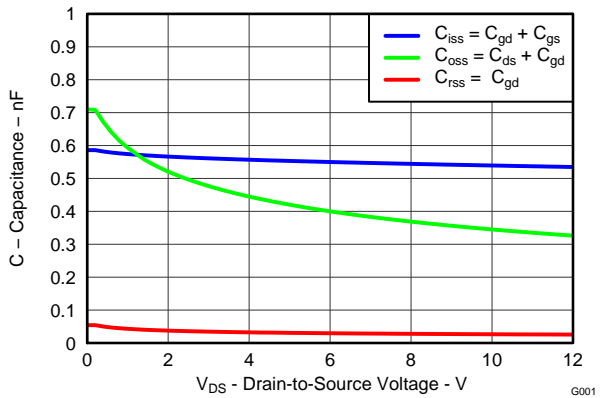

**Figure 5. Capacitance**

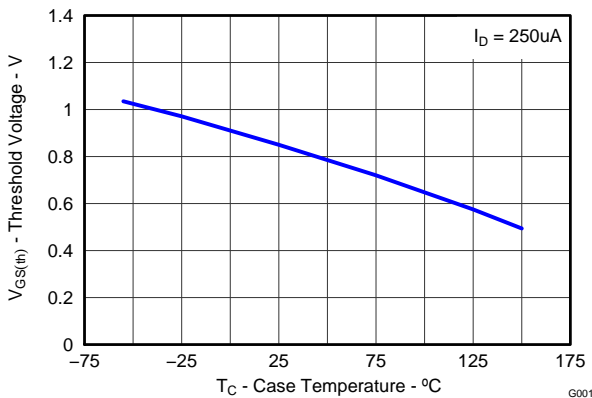

**Figure 6. Threshold Voltage vs. Temperature**

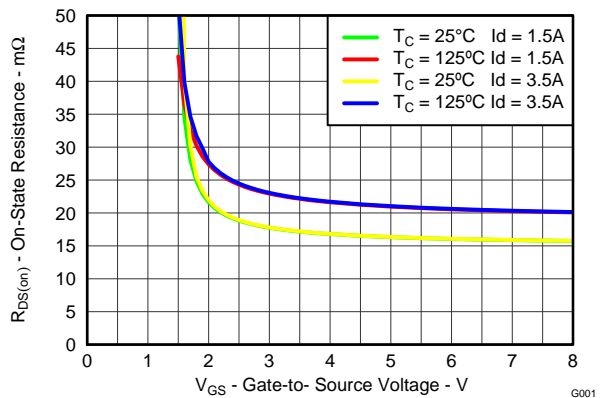

**Figure 7. On Resistance vs. Gate Voltage**

TYPICAL MOSFET CHARACTERISTICS (continued)

( $T_A = 25^\circ\text{C}$  unless otherwise stated)

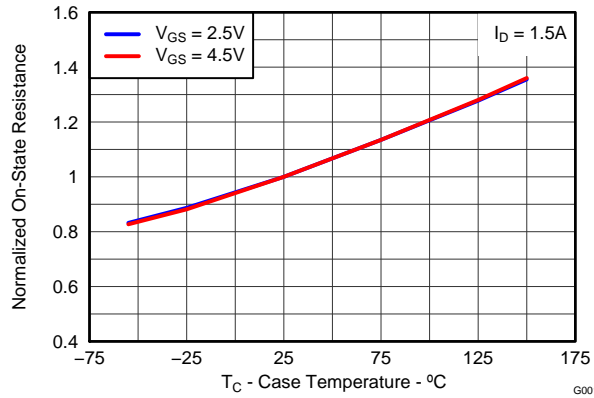

Figure 8. Normalized On Resistance vs. Temperature

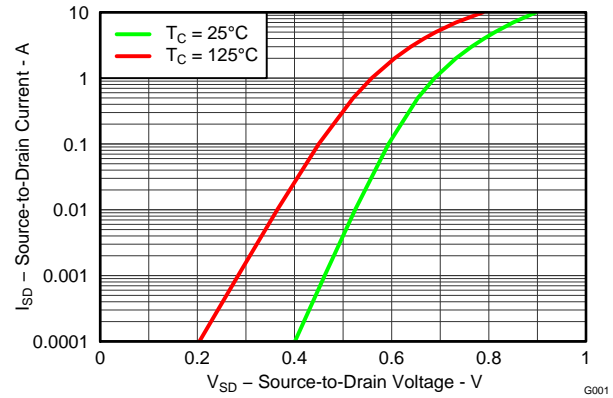

Figure 9. Typical Diode Forward Voltage

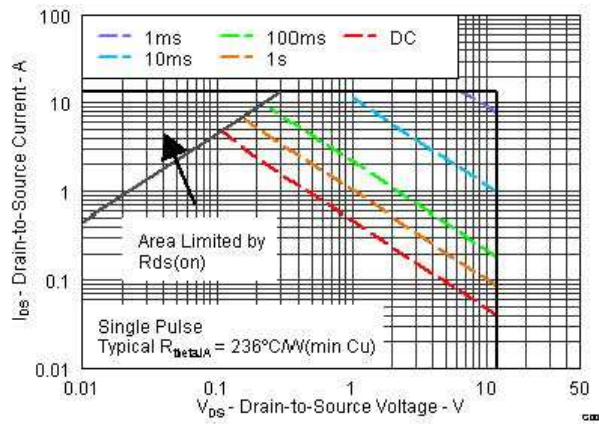

Figure 10. Maximum Safe Operating Area

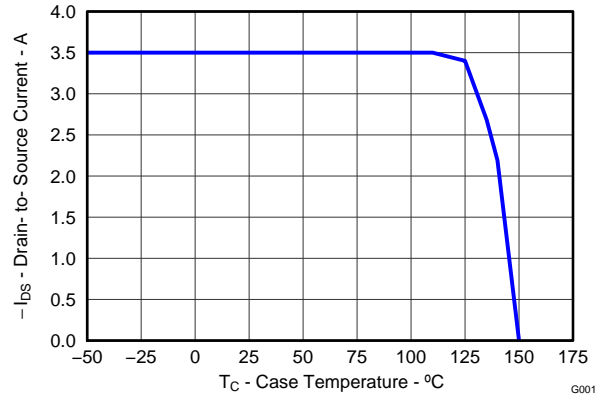

Figure 11. Maximum Drain Current vs. Temperature

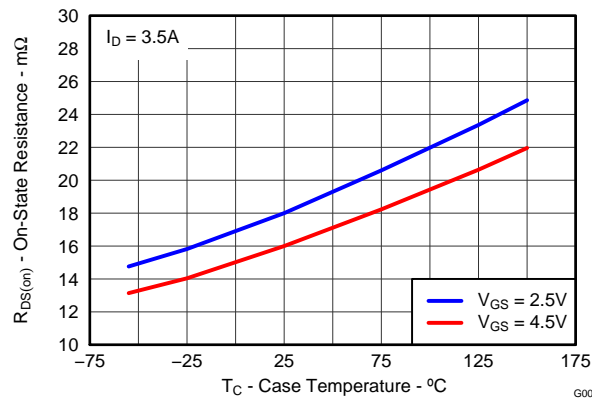
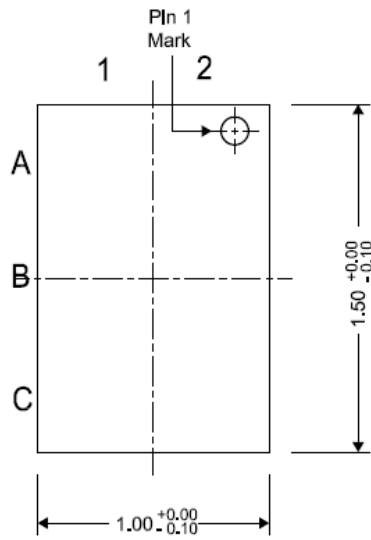

Figure 12. On Resistance vs. Temperature

**MECHANICAL DATA**

**CSD13303W1015 Package Dimensions**



Top View

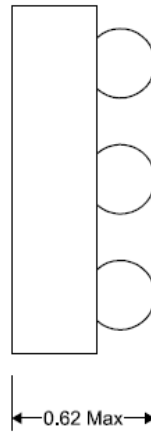

Side View

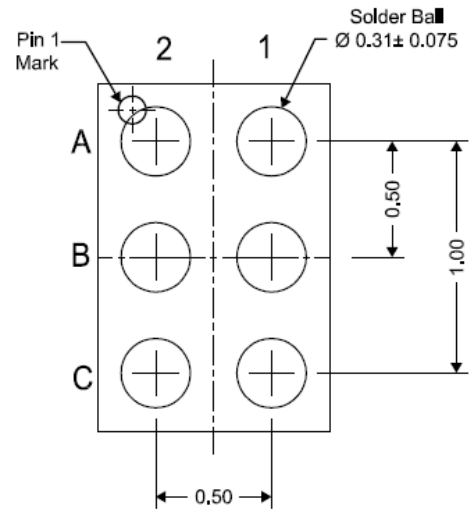

Bottom View

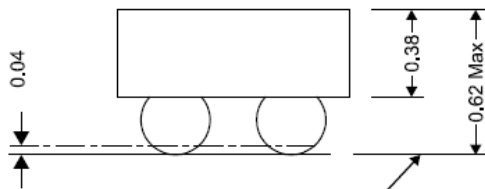

Seating Plane

Front View

NOTE: All dimensions are in mm (unless otherwise specified)

**Pinout**

POSITION	DESIGNATION
C2, B2	Source
A2	Gate
A1, B1, C1	Drain

Land Pattern Recommendation

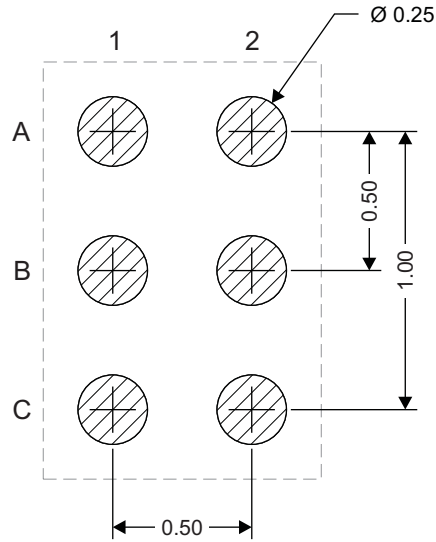

M0158-01

NOTE: All dimensions are in mm (unless otherwise specified)

Tape and Reel Information

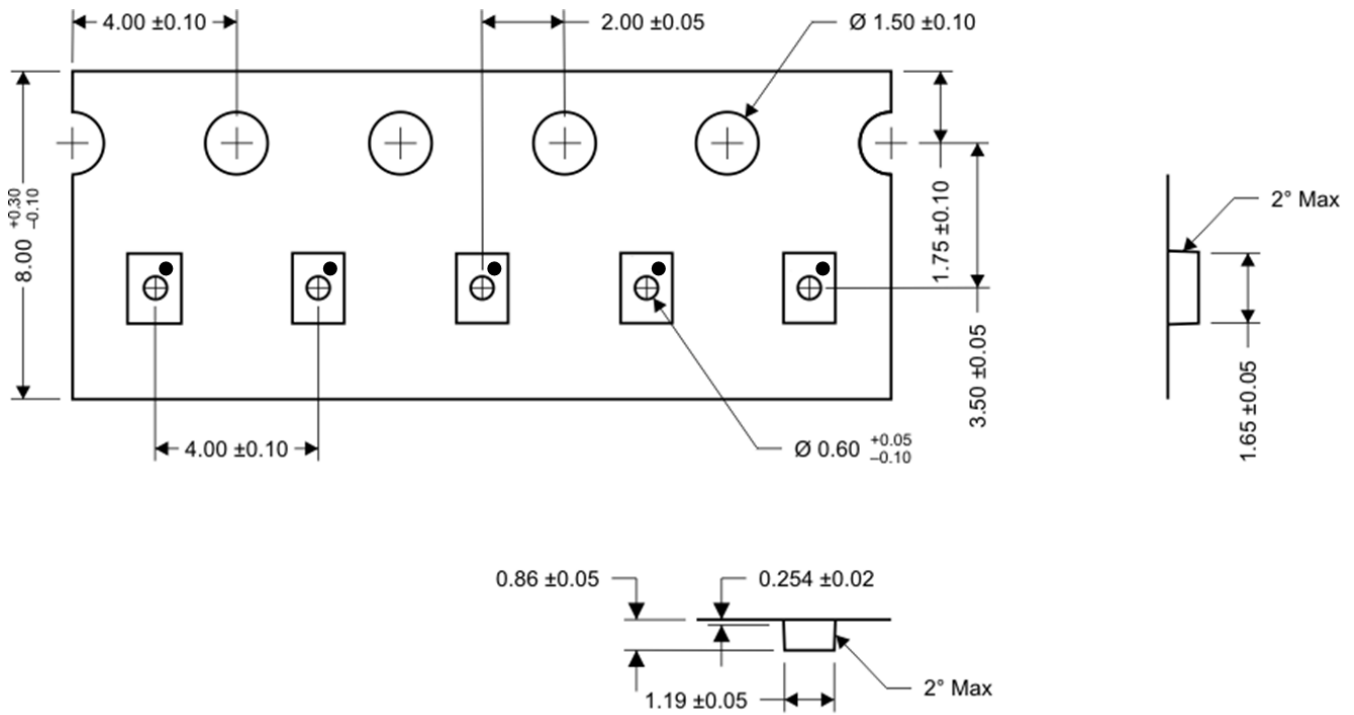

M0159-01

NOTE: All dimensions are in mm (unless otherwise specified)

---

## REVISION HISTORY

Changes from Original (May 2012) to Revision A	Page
• Changed the Tape and Reel Information section .....	7

---



**PACKAGING INFORMATION**

Orderable Device	Status (1)	Package Type	Package Drawing	Pins	Package Qty	Eco Plan (2)	Lead/Ball Finish	MSL Peak Temp (3)	Op Temp (°C)	Device Marking (4/5)	Samples
CSD13303W1015	PREVIEW	DSBGA	YZC	6	3000	Green (RoHS & no Sb/Br)	SNAGCU	Level-1-260C-UNLIM	-50 to 150	13303	

(1) The marketing status values are defined as follows:

**ACTIVE:** Product device recommended for new designs.

**LIFEBUY:** TI has announced that the device will be discontinued, and a lifetime-buy period is in effect.

**NRND:** Not recommended for new designs. Device is in production to support existing customers, but TI does not recommend using this part in a new design.

**PREVIEW:** Device has been announced but is not in production. Samples may or may not be available.

**OBSOLETE:** TI has discontinued the production of the device.

(2) Eco Plan - The planned eco-friendly classification: Pb-Free (RoHS), Pb-Free (RoHS Exempt), or Green (RoHS & no Sb/Br) - please check <http://www.ti.com/productcontent> for the latest availability information and additional product content details.

**TBD:** The Pb-Free/Green conversion plan has not been defined.

**Pb-Free (RoHS):** TI's terms "Lead-Free" or "Pb-Free" mean semiconductor products that are compatible with the current RoHS requirements for all 6 substances, including the requirement that lead not exceed 0.1% by weight in homogeneous materials. Where designed to be soldered at high temperatures, TI Pb-Free products are suitable for use in specified lead-free processes.

**Pb-Free (RoHS Exempt):** This component has a RoHS exemption for either 1) lead-based flip-chip solder bumps used between the die and package, or 2) lead-based die adhesive used between the die and leadframe. The component is otherwise considered Pb-Free (RoHS compatible) as defined above.

**Green (RoHS & no Sb/Br):** TI defines "Green" to mean Pb-Free (RoHS compatible), and free of Bromine (Br) and Antimony (Sb) based flame retardants (Br or Sb do not exceed 0.1% by weight in homogeneous material)

(3) MSL, Peak Temp. -- The Moisture Sensitivity Level rating according to the JEDEC industry standard classifications, and peak solder temperature.

(4) There may be additional marking, which relates to the logo, the lot trace code information, or the environmental category on the device.

(5) Multiple Device Markings will be inside parentheses. Only one Device Marking contained in parentheses and separated by a "~" will appear on a device. If a line is indented then it is a continuation of the previous line and the two combined represent the entire Device Marking for that device.

**Important Information and Disclaimer:** The information provided on this page represents TI's knowledge and belief as of the date that it is provided. TI bases its knowledge and belief on information provided by third parties, and makes no representation or warranty as to the accuracy of such information. Efforts are underway to better integrate information from third parties. TI has taken and continues to take reasonable steps to provide representative and accurate information but may not have conducted destructive testing or chemical analysis on incoming materials and chemicals. TI and TI suppliers consider certain information to be proprietary, and thus CAS numbers and other limited information may not be available for release.

In no event shall TI's liability arising out of such information exceed the total purchase price of the TI part(s) at issue in this document sold by TI to Customer on an annual basis.

YZC (R-XBGA-N6)

DIE-SIZE BALL GRID ARRAY

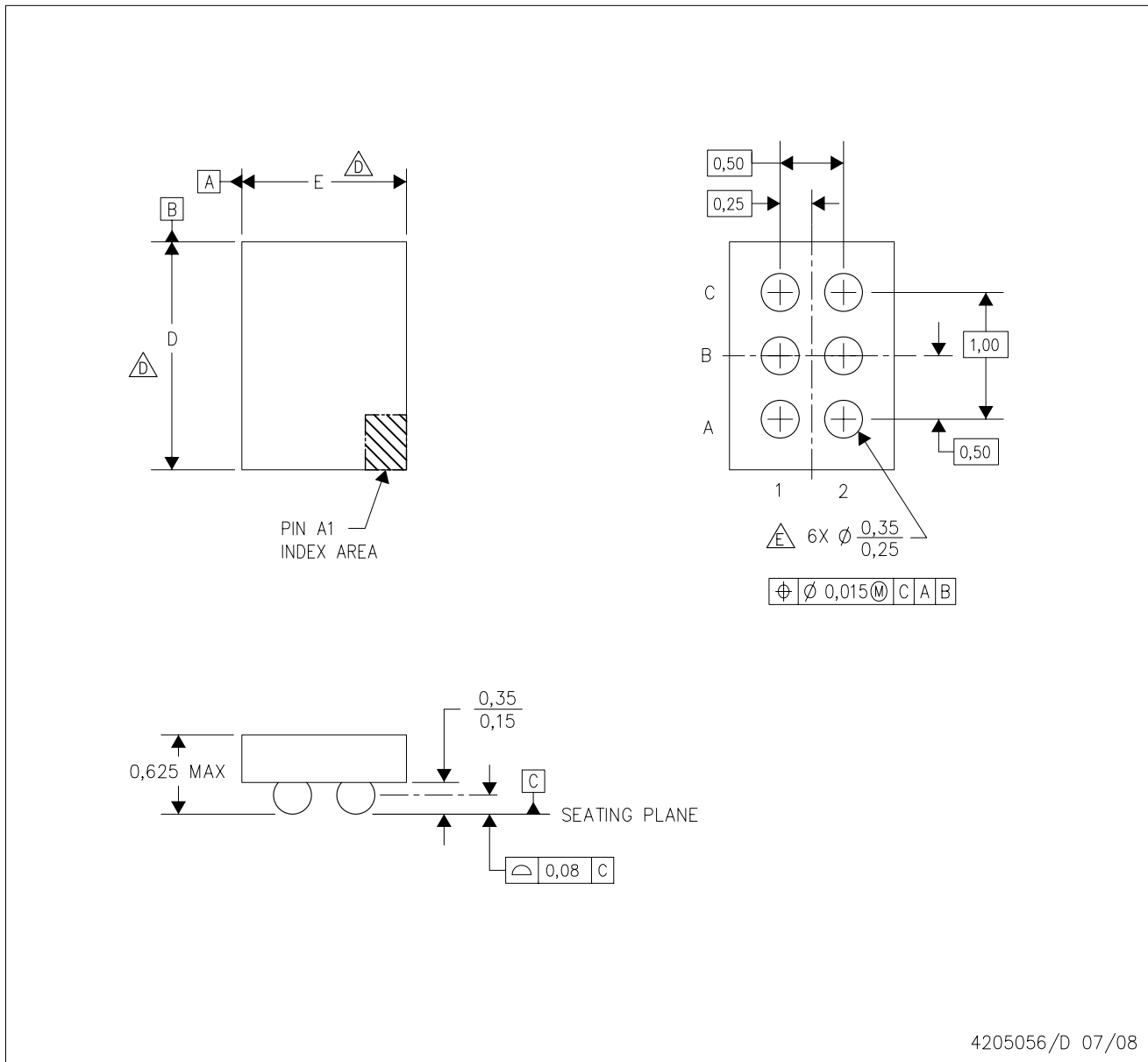

- NOTES:
- A. All linear dimensions are in millimeters.
  - B. This drawing is subject to change without notice.
  - C. NanoFree™ package configuration.
  - $\triangle D$  Devices in YZC package can have dimension D ranging from 1.44 to 2.15 mm and dimension E ranging from 0.94 to 1.65 mm. To determine the exact package size of a particular device, refer to the device datasheet or contact a local TI representative.
  - E. Reference Product Data Sheet for array population.  
3 x 2 matrix pattern is shown for illustration only.
  - F. This package contains lead-free balls.  
Refer to YEC (Drawing #4204179) for tin-lead (SnPb) balls.

## IMPORTANT NOTICE

Texas Instruments Incorporated and its subsidiaries (TI) reserve the right to make corrections, enhancements, improvements and other changes to its semiconductor products and services per JESD46, latest issue, and to discontinue any product or service per JESD48, latest issue. Buyers should obtain the latest relevant information before placing orders and should verify that such information is current and complete. All semiconductor products (also referred to herein as "components") are sold subject to TI's terms and conditions of sale supplied at the time of order acknowledgment.

TI warrants performance of its components to the specifications applicable at the time of sale, in accordance with the warranty in TI's terms and conditions of sale of semiconductor products. Testing and other quality control techniques are used to the extent TI deems necessary to support this warranty. Except where mandated by applicable law, testing of all parameters of each component is not necessarily performed.

TI assumes no liability for applications assistance or the design of Buyers' products. Buyers are responsible for their products and applications using TI components. To minimize the risks associated with Buyers' products and applications, Buyers should provide adequate design and operating safeguards.

TI does not warrant or represent that any license, either express or implied, is granted under any patent right, copyright, mask work right, or other intellectual property right relating to any combination, machine, or process in which TI components or services are used. Information published by TI regarding third-party products or services does not constitute a license to use such products or services or a warranty or endorsement thereof. Use of such information may require a license from a third party under the patents or other intellectual property of the third party, or a license from TI under the patents or other intellectual property of TI.

Reproduction of significant portions of TI information in TI data books or data sheets is permissible only if reproduction is without alteration and is accompanied by all associated warranties, conditions, limitations, and notices. TI is not responsible or liable for such altered documentation. Information of third parties may be subject to additional restrictions.

Resale of TI components or services with statements different from or beyond the parameters stated by TI for that component or service voids all express and any implied warranties for the associated TI component or service and is an unfair and deceptive business practice. TI is not responsible or liable for any such statements.

Buyer acknowledges and agrees that it is solely responsible for compliance with all legal, regulatory and safety-related requirements concerning its products, and any use of TI components in its applications, notwithstanding any applications-related information or support that may be provided by TI. Buyer represents and agrees that it has all the necessary expertise to create and implement safeguards which anticipate dangerous consequences of failures, monitor failures and their consequences, lessen the likelihood of failures that might cause harm and take appropriate remedial actions. Buyer will fully indemnify TI and its representatives against any damages arising out of the use of any TI components in safety-critical applications.

In some cases, TI components may be promoted specifically to facilitate safety-related applications. With such components, TI's goal is to help enable customers to design and create their own end-product solutions that meet applicable functional safety standards and requirements. Nonetheless, such components are subject to these terms.

No TI components are authorized for use in FDA Class III (or similar life-critical medical equipment) unless authorized officers of the parties have executed a special agreement specifically governing such use.

Only those TI components which TI has specifically designated as military grade or "enhanced plastic" are designed and intended for use in military/aerospace applications or environments. Buyer acknowledges and agrees that any military or aerospace use of TI components which have **not** been so designated is solely at the Buyer's risk, and that Buyer is solely responsible for compliance with all legal and regulatory requirements in connection with such use.

TI has specifically designated certain components as meeting ISO/TS16949 requirements, mainly for automotive use. In any case of use of non-designated products, TI will not be responsible for any failure to meet ISO/TS16949.

### Products

Audio	<a href="http://www.ti.com/audio">www.ti.com/audio</a>
Amplifiers	<a href="http://amplifier.ti.com">amplifier.ti.com</a>
Data Converters	<a href="http://dataconverter.ti.com">dataconverter.ti.com</a>
DLP® Products	<a href="http://www.dlp.com">www.dlp.com</a>
DSP	<a href="http://dsp.ti.com">dsp.ti.com</a>
Clocks and Timers	<a href="http://www.ti.com/clocks">www.ti.com/clocks</a>
Interface	<a href="http://interface.ti.com">interface.ti.com</a>
Logic	<a href="http://logic.ti.com">logic.ti.com</a>
Power Mgmt	<a href="http://power.ti.com">power.ti.com</a>
Microcontrollers	<a href="http://microcontroller.ti.com">microcontroller.ti.com</a>
RFID	<a href="http://www.ti-rfid.com">www.ti-rfid.com</a>
OMAP Applications Processors	<a href="http://www.ti.com/omap">www.ti.com/omap</a>
Wireless Connectivity	<a href="http://www.ti.com/wirelessconnectivity">www.ti.com/wirelessconnectivity</a>

### Applications

Automotive and Transportation	<a href="http://www.ti.com/automotive">www.ti.com/automotive</a>
Communications and Telecom	<a href="http://www.ti.com/communications">www.ti.com/communications</a>
Computers and Peripherals	<a href="http://www.ti.com/computers">www.ti.com/computers</a>
Consumer Electronics	<a href="http://www.ti.com/consumer-apps">www.ti.com/consumer-apps</a>
Energy and Lighting	<a href="http://www.ti.com/energy">www.ti.com/energy</a>
Industrial	<a href="http://www.ti.com/industrial">www.ti.com/industrial</a>
Medical	<a href="http://www.ti.com/medical">www.ti.com/medical</a>
Security	<a href="http://www.ti.com/security">www.ti.com/security</a>
Space, Avionics and Defense	<a href="http://www.ti.com/space-avionics-defense">www.ti.com/space-avionics-defense</a>
Video and Imaging	<a href="http://www.ti.com/video">www.ti.com/video</a>

### TI E2E Community

[e2e.ti.com](http://e2e.ti.com)