



This integrated circuit can be damaged by ESD. Texas Instruments recommends that all integrated circuits be handled with appropriate precautions. Failure to observe proper handling and installation procedures can cause damage.

ESD damage can range from subtle performance degradation to complete device failure. Precision integrated circuits may be more susceptible to damage because very small parametric changes could cause the device not to meet its published specifications.

DESCRIPTION (CONTINUED)

The bq2407xT features dynamic power path management (DPPM) that powers the system while simultaneously and independently charging the battery. The DPPM circuit reduces the charge current when the input current limit causes the system output to fall to the DPPM threshold; thus, supplying the system load at all times while monitoring the charge current separately. This feature reduces the number of charge and discharge cycles on the battery, allows for proper charge termination and enables the system to run with a defective or absent battery pack.

Additionally, the regulated system input enables instant system turn-on when plugged in even with a totally discharged battery. The power-path management architecture also permits the battery to supplement the system current requirements when the adapter cannot deliver the peak system currents, enabling the use of a smaller adapter.

The battery is charged in three phases: conditioning, constant current, and constant voltage. In all charge phases, an internal control loop monitors the IC junction temperature and reduces the charge current if the internal temperature threshold is exceeded. The charger power stage and charge current sense functions are fully integrated. The charger function has high accuracy current and voltage regulation loops, charge status display, and charge termination. The input current limit and charge current are programmable using external resistors.

ORDERING INFORMATION

PART NO. ⁽¹⁾ ⁽²⁾	V _{OVP}	V _{BAT(REG)}	V _{OUT(REG)}	V _{DPPM}	OPTIONAL FUNCTION	MARKING
bq24072TRGTR	6.6V	4.2 V	V _{BAT} + 225 mV	V _{OREG} –100 mV	TD	PAP
bq24072TRGTT	6.6V	4.2 V	V _{BAT} + 225 mV	V _{OREG} –100 mV	TD	PAP
bq24075TRGTR	6.6 V	4.2 V	5.5 V	4.3 V	SYSOFF	OEC
bq24075TRGTT	6.6 V	4.2 V	5.5 V	4.3 V	SYSOFF	OEC
bq24079TRGTR	6.6 V	4.1 V	5.5 V	4.3 V	SYSOFF	OED
bq24079TRGTT	6.6 V	4.1 V	5.5 V	4.3 V	SYSOFF	OED

- (1) The RGT package is available in the following options:
R – taped and reeled in quantities of 3,000 devices per reel.
T – taped and reeled in quantities of 250 devices per reel.
- (2) This product is RoHS compatible, including a lead concentration that does not exceed 0.1% of total product weight and is suitable for use in specified lead-free soldering processes. In addition, this product uses package materials that do not contain halogens, including bromine (BR) or antimony (Sb) above 0.1% of total product weight.

ABSOLUTE MAXIMUM RATINGS^{(1) (2)}

over operating free-air temperature range (unless otherwise noted)

		VALUE / UNIT
Input voltage	IN (with respect to VSS)	–0.3 to 28 V
	BAT (with respect to VSS)	–0.3V to 5V
	OUT, EN1, EN2, \overline{CE} , TS, ISET, \overline{PGOOD} , \overline{CHG} , ILIM, VREF, ITERM, SYSOFF, TD (with respect to VSS)	–0.3 TO 7 V
Input current	IN	1.6 A
Output current (Continuous)	OUT	5A
	BAT (Discharge mode)	5A
	BAT (Charging mode)	1.5A
Output sink current	\overline{CHG} , \overline{PGOOD}	15 mA
Junction temperature, T _J		–40°C to 150°C
Storage temperature, T _{STG}		–65°C to 150°C

- Stresses beyond those listed under *absolute maximum ratings* may cause permanent damage to the device. These are stress ratings only, and functional operation of the device at these or any other conditions beyond those indicated under *recommended operating conditions* is not implied. Exposure to absolute-maximum-rated conditions for extended periods may affect device reliability.
- The IC operational charging life is reduced to 20,000 hours, when charging at 1.5A and 125°C. The thermal regulation feature reduces charge current if the IC's junction temperature reaches 125°C; thus without a good thermal design the maximum programmed charge current may not be reached.

DISSIPATION RATINGS

PACKAGE	R _{θJA}	R _{θJC}	T _A < 25°C POWER RATING	DERATING FACTOR ABOVE T _A = 25°C
QFN-16 RGT	39.47 °C/W	2.4°C/W	2.3 W	225 mW

RECOMMENDED OPERATING CONDITIONS

over operating free-air temperature range (unless otherwise noted)

		MIN	MAX	UNITS
V _{IN}	IN voltage range	4.35	26	V
	IN operating voltage range	4.35	6.4	V
I _{IN}	Input current, IN pin		1.5	A
I _{OUT}	Current, OUT pin		4.5	A
I _{BAT}	Current, BAT pin (Discharging)		4.5	A
I _{CHG}	Current, BAT pin (Charging)		1.5 ⁽¹⁾	A
T _J	Junction Temperature	0	125	°C
R _{ILIM}	Maximum input current programming resistor	1.07	7.5	kΩ
R _{ISET}	Fast-charge current programming resistor ⁽²⁾	590	3000	Ω
R _{ITERM}	Termination current programming resistor	0	15	kΩ
R _{TMR}	Timer programming resistor	18	72	kΩ

- The IC operational charging life is reduced to 20,000 hours, when charging at 1.5A and 125°C. The thermal regulation feature reduces charge current if the IC's junction temperature reaches 125°C; thus without a good thermal design the maximum programmed charge current may not be reached.
- Use a 1% tolerance resistor R_{ISET} to avoid issues with the R_{ISET} short test when using the maximum charge current setting.

ELECTRICAL CHARACTERISTICS

Over junction temperature range ($0^{\circ}\text{C} < T_j < 125^{\circ}\text{C}$) and the recommended supply voltage range (unless otherwise noted)

PARAMETER		TEST CONDITIONS	MIN	TYP	MAX	UNIT
INPUT						
V_{UVLO}	Under-voltage lock-out	$V_{IN}: 0V \rightarrow 4V$	3.2	3.3	3.4	V
$V_{HYS-UVLO}$	Hysteresis on UVLO	$V_{IN}: 4V \rightarrow 0V$	200		300	mV
V_{IN-DT}	Input power detection threshold	(Input power detected if $V_{IN} > V_{BAT} + V_{IN-DT}$) $V_{BAT} = 3.6V, V_{IN}: 3.5V \rightarrow 4V$	55	80	140	mV
$V_{HYS-INDT}$	Hysteresis on V_{IN-DT}	$V_{BAT} = 3.6V, V_{IN}: 4V \rightarrow 3.5V$	20			mV
$t_{DGL(PGOOD)}$	Deglint time, input power detected status	Time measured from $V_{IN}: 0V \rightarrow 5V$, $1\mu\text{s}$ rise-time to $PGOOD = LO$		1.2		ms
V_{OVP}	Input overvoltage protection threshold	$V_{IN}: 5V \rightarrow 7V$	6.4	6.6	6.8	V
$V_{HYS-OVP}$	Hysteresis on OVP	$V_{IN}: 7V \rightarrow 5V$		240		mV
$t_{BLK(OVP)}$	Input over-voltage blanking time			50		μs
$t_{REC(OVP)}$	Input over-voltage recovery time	Time measured from $V_{IN}: 11V \rightarrow 5V$ $1\mu\text{s}$ fall-time to $PGOOD = LO$		1.2		ms
ILIM, ISET SHORT CIRCUIT TEST						
I_{SC}	Current source			1.3		mA
V_{SC}				520		mV
QUIESCENT CURRENT						
$I_{BAT(PDWN)}$	Sleep current into BAT pin	$\overline{CE} = LO$ or HI , input power not detected, no load on OUT pin			6.5	μA
$I_{IN(STDBY)}$	Standby current into IN pin	$EN1 = HI, EN2 = HI, V_{IN} \leq 6V$			50	μA
		$EN1 = HI, EN2 = HI, V_{IN} > 6V$			200	
I_{CC}	Active supply current, IN pin	$\overline{CE} = LO, V_{IN} = 6V$, no load on OUT pin, $V_{BAT} > V_{BAT(REG)}, (EN1, EN2) \neq (HI, HI)$			1.5	mA
POWER PATH						
$V_{DO(IN-OUT)}$	$V_{IN} - V_{OUT}$	$V_{IN} = 4.3V, I_{IN} = 1A, V_{BAT} = 4.2V$		300	475	mV
$V_{DO(BAT-OUT)}$	$V_{BAT} - V_{OUT}$	$I_{OUT} = 1A, V_{IN} = 0V, V_{BAT} > 3V$		50	100	mV
$V_{O(REG)}$	OUT pin voltage regulation (bq24072T)	$V_{IN} > V_{OUT} + V_{DO(IN-OUT)}, V_{BAT} < 3.2V$	3.3	3.4	3.5	V
		$V_{IN} > V_{OUT} + V_{DO(IN-OUT)}, V_{BAT} \geq 3.2V$	$V_{BAT} + 150\text{mV}$	$V_{BAT} + 225\text{mV}$	$V_{BAT} + 270\text{mV}$	
	OUT pin voltage regulation (bq24075T, bq24079T)	$V_{IN} > V_{OUT} + V_{DO(IN-OUT)}$	5.4	5.5	5.6	
I_{IN-MAX}	Maximum input current	$EN1 = LO, EN2 = LO$	90	95	100	mA
		$EN1 = HI, EN2 = LO$	450	475	500	mA
		$EN2 = HI, EN1 = LO$	K_{ILIM}/R_{ILIM}			A
K_{ILIM}	Maximum input current factor	$ILIM \geq 500\text{mA}$	1500	1600	1700	A Ω
		$200\text{mA} < ILIM < 500\text{mA}$	1330	1512	1700	
I_{IN-MAX}	Programmable input current limit range	$EN2 = HI, EN1 = LO, R_{ILIM} = 8\text{k}\Omega$ to $1.1\text{k}\Omega$	200		1500	mA
V_{IN-LOW}	Input voltage threshold when input current is reduced	$EN2 = LO, EN1 = X$	4.35	4.5	4.63	V
V_{DPPM}	Output voltage threshold when charging current is reduced	bq24072T	$V_{O(REG)} - 180\text{mV}$	$V_{O(REG)} - 100\text{mV}$	$V_{O(REG)} - 30\text{mV}$	V
		bq24075T, bq24079T	4.2	4.3	4.4	
V_{BSUP1}	Enter battery supplement mode	V_{OUT} falling, Supplement mode entered when $V_{OUT} < V_{BSUP1}$		$V_{BAT} - 40\text{mV}$		V
V_{BSUP2}	Exit battery supplement mode	V_{OUT} rising, Supplement mode exited when $V_{OUT} > V_{BSUP2}$		$V_{BAT} - 20\text{mV}$		V
$V_{O(SC1)}$	Output short-circuit detection threshold, power-on		0.8	0.9	1.0	V
$V_{O(SC2)}$	Output short-circuit detection threshold, supplement mode $V_{BAT} - V_{OUT} > V_{O(SC2)}$ indicates short-circuit		200	250	300	mV

ELECTRICAL CHARACTERISTICS (continued)

 Over junction temperature range ($0^{\circ}\text{C} < T_J < 125^{\circ}\text{C}$) and the recommended supply voltage range (unless otherwise noted)

PARAMETER		TEST CONDITIONS	MIN	TYP	MAX	UNIT
$t_{DGL(SC2)}$	Deglitch time, supplement mode short circuit			250		μs
$t_{REC(SC2)}$	Recovery time, supplement mode short circuit			60		ms
BATTERY CHARGER						
$I_{BAT(SC)}$	Source current for BAT pin short-circuit detection		4	7.5	11	mA
$V_{BAT(SC)}$	BAT pin short-circuit detection threshold		1.6	1.8	2.0	V
$V_{BAT(REG)}$	Battery charge voltage	bq24072T, bq24075T	4.16	4.20	4.24	V
		bq24079T	4.059	4.100	4.141	
V_{LOWV}	Pre-charge to fast-charge transition threshold		2.9	3	3.1	V
$t_{DGL1(LOWV)}$	Deglitch time on pre-charge to fast-charge transition			25		ms
$t_{DGL2(LOWV)}$	Deglitch time on fast-charge to pre-charge transition			25		ms
I_{CHG}	Battery fast charge current range	$V_{BAT(REG)} > V_{BAT} > V_{LOWV}$, $V_{IN} = 5\text{V}$, $\overline{CE} = \text{LO}$, EN1= LO, EN2 = HI	300		1500	mA
I_{CHG}	Battery fast charge current	$\overline{CE} = \text{LO}$, EN1= LO, EN2 = HI, $V_{BAT} > V_{LOWV}$, $V_{IN} = 5\text{V}$, $I_{IN-MAX} > I_{CHG}$, no load on OUT pin, thermal loop not active, DPM loop not active		K_{ISET}/R_{ISET}		A
K_{ISET}	Fast charge current factor		797	890	975	AQ
I_{PRECHG}	Pre-charge current			K_{PRECHG}/R_{ISET}		A
k_{PRECHG}	Pre-charge current factor		70	88	106	
I_{TERM}	Charge current value for termination detection threshold	$\overline{CE} = \text{LO}$, (EN1,EN2) \neq (LO,LO), $V_{BAT} > V_{RCH}$, $t < t_{MAXCH}$, $V_{IN} = 5\text{V}$, DPM loop not active, thermal loop not active	$0.09 \times I_{CHG}$	$0.1 \times I_{CHG}$	$0.11 \times I_{CHG}$	
		$\overline{CE} = \text{LO}$, (EN1,EN2)=(LO,LO), $V_{BAT} > V_{RCH}$, $t < t_{MAXCH}$, $V_{IN} = 5\text{V}$, DPM loop not active, thermal loop not active	$0.027 \times I_{CHG}$	$.033 \times I_{CHG}$	$0.040 \times I_{CHG}$	
$t_{DGL(TERM)}$	Deglitch time, termination detected			25		ms
V_{RCH}	Recharge detection threshold		$V_{O(REG)} - 140\text{mV}$	$V_{O(REG)} - 100\text{mV}$	$V_{O(REG)} - 60\text{mV}$	V
$t_{DGL(RCH)}$	Deglitch time, recharge threshold detected			62.5		ms
$t_{DGL(NO-IN)}$	Delay time, input power loss to charger turn-off	$V_{BAT} = 3.6\text{V}$. Time measured from V_{IN} : $5\text{V} \rightarrow 3.3\text{V}$ $1\mu\text{s}$ fall-time		20		ms
$I_{BAT(DET)}$	Sink current for battery detection		5	7.5	10	mA
t_{DET}	Battery detection timer			250		ms
BATTERY CHARGING TIMERS						
t_{PRECHG}	Pre-charge safety timer value	TMR = floating	1440	1800	2160	s
t_{MAXCH}	Charge safety timer value	TMR = floating	14400	18000	21600	s
t_{PRECHG}	Pre-charge safety timer value(externally set)	$18\text{k}\Omega < R_{TMR} < 72\text{k}\Omega$		$R_{TMR} \times K_{TMR}$		s
t_{MAXCH}	Charge safety timer value (externally set)	$18\text{k}\Omega < R_{TMR} < 72\text{k}\Omega$		$10 \times R_{TMR} \times K_{TMR}$		s
K_{TMR}	Timer factor		35	45	55	s / k Ω
BATTERY – PACK NTC MONITOR						
V_{HOT}	High temperature trip point	Battery charging	12	12.5	13	% of V_{IN}
$V_{HYS(HOT)}$	Hysteresis on high trip point	Battery charging		1		% of V_{IN}
V_{COLD}	Low temperature trip point	Battery charging	24.5	25	25.5	% of V_{IN}
$V_{HYS(COLD)}$	Hysteresis on low trip point	Battery charging		1		% of V_{IN}

ELECTRICAL CHARACTERISTICS (continued)

Over junction temperature range ($0^{\circ}\text{C} < T_J < 125^{\circ}\text{C}$) and the recommended supply voltage range (unless otherwise noted)

PARAMETER		TEST CONDITIONS	MIN	TYP	MAX	UNIT
$t_{DGL(TS)}$	Deglitch time, pack temperature fault detection	Battery charging		50		ms
THERMAL REGULATION						
$T_{J(REG)}$	Temperature Regulation Limit			125		$^{\circ}\text{C}$
$T_{J(OFF)}$	Thermal shutdown temperature			155		$^{\circ}\text{C}$
$T_{J(OFF-HYS)}$	Thermal shutdown hysteresis			20		$^{\circ}\text{C}$
LOGIC LEVELS ON EN1, EN2, \overline{CE}, SYSOFF, TD						
V_{IL}	Logic LOW input voltage		0		0.4	V
V_{IH}	Logic HIGH input voltage		1.4		6.0	V
I_{iL}					1	μA
I_{iH}					10	μA
LOGIC LEVELS ON \overline{PGOOD}, \overline{CHG}						
V_{OL}	Output LOW voltage	$I_{SINK} = 5 \text{ mA}$			0.4	V

DEVICE INFORMATION

PIN DIAGRAM

Pin out designations are not final. Subject to change.

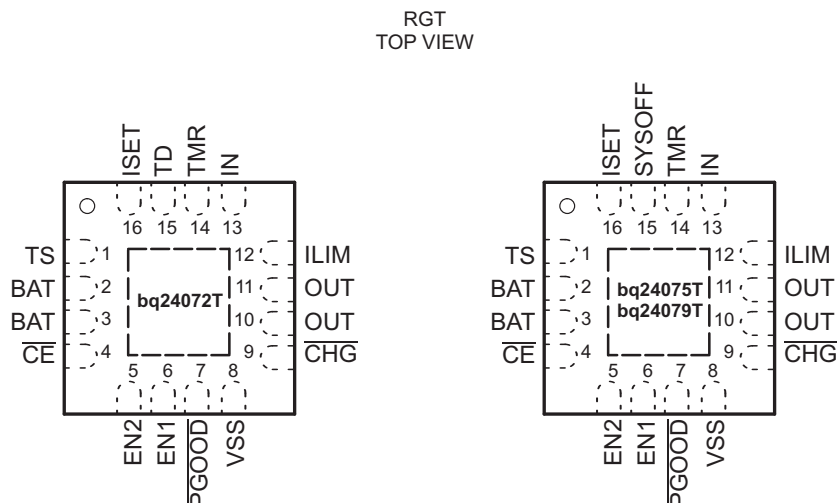

TERMINAL FUNCTIONS

NAME	PIN NUMBER		I/O	DESCRIPTION
	bq24072T	bq24075T bq24079T		
TS	1	1	I/O	External NTC Thermistor Input. Connect the TS input to the center tap of a resistor divider from V_{IN} to GND with the NTC in parallel with the bottom resistor to monitor the NTC in the battery pack. For applications that do not utilize the TS function, set the resistor divider to be a 20% ratio. See the Battery Pack Temperature Monitoring section for details on calculating the resistor values.
BAT	2, 3	2, 3	I/O	Charger Power Stage Output and Battery Voltage Sense Input. Connect BAT to the positive terminal of the battery. Bypass BAT to VSS with a 4.7 μ F to 47 μ F ceramic capacitor.
\overline{CE}	4	4	I	Charge Enable Active-Low Input. Connect \overline{CE} to a high logic level to place the battery charger in standby mode. In standby mode, OUT is active and battery supplement mode is available. Connect /CE to a low logic level to enable the battery charger. CE is internally pulled down with ~285k Ω . Do not leave \overline{CE} unconnected to ensure proper operation.
EN2	5	5	I	Input Current Limit Configuration Inputs. Use EN1 and EN2 to control the maximum input current and enable USB compliance. See Table 1 for the description of the operation states. EN1 and EN2 are internally pulled down with ~285k Ω . Do not leave EN1 or EN2 unconnected to ensure proper operation.
EN1	6	6	I	
\overline{PGOOD}	7	7	O	Open-Drain Power Good Status Indication Output. \overline{PGOOD} pulls to VSS when a valid input source is detected. \overline{PGOOD} is high-impedance when the input power is not within specified limits. Connect \overline{PGOOD} to the desired logic voltage rail using a 1k Ω to 100k Ω resistor, or use with an LED for visual indication.
VSS	8	8	–	Ground. Connect to the thermal pad and to the ground rail of the circuit.
\overline{CHG}	9	9	O	Open-Drain Charging Status Indication Output. \overline{CHG} pulls to VSS when the battery is charging. \overline{CHG} is high-impedance when charging is complete or when the charger is disabled. \overline{CHG} flashes to indicate a timer fault. Connect \overline{CHG} to the desired logic voltage rail using a 1k Ω to 100k Ω resistor, or use with an LED for visual indication.
OUT	10, 11	10, 11	O	System Supply Output. OUT provides a regulated output when the input is below the OVP threshold and above the regulation voltage. When the input is out of the operation range, OUT is connected to VBAT except when SYSOFF is high. Connect OUT to the system load. Bypass OUT to VSS with a 4.7 μ F to 47 μ F ceramic capacitor.
ILIM	12	12	O	Adjustable Current Limit Programming Input. Connect a 1.07k Ω to 7.5k Ω resistor from ILIM to VSS to program the maximum input current (EN2=1, EN1=0). The input current includes the system load and the battery charge current. Leaving ILIM unconnected disables all charging.

TERMINAL FUNCTIONS (continued)

NAME	PIN NUMBER		I/O	DESCRIPTION
	bq24072T	bq24075T bq24079T		
IN	13	13	I	Input Power Connection. Connect IN to the external DC supply (AC adapter or USB port). The input operating range is 4.35V to 6.6V. The input accepts voltages up to 26V without damage, but operation is suspended. Bypass IN to VS with a 1 μ F to 10 μ F ceramic capacitor.
TMR	14	14	I	Timer Programming Input. TMR controls the pre-charge and fast-charge safety timers. Connect TMR to VSS to disable all safety timers. Connect a 18k Ω to 72k Ω resistor between TMR and VSS to program the timers to a desired length. Leave TMR unconnected to set the timers to the default values.
SYSOFF	–	15	I	System Enable Input. Connect SYSOFF high to turn off the FET connecting the battery to the system output. When an adapter is connected, charge is also disabled. Connect SYSOFF low for normal operation. SYSOFF is internally pulled up to VBAT through a large resistor (~5M Ω). Do not leave SYSOFF unconnected to ensure proper operation.
TD	15	–	I	Termination Disable Input. Connect TD high to disable charger termination. Connect TD to VSS to enable charger termination. TD is checked during startup only and cannot be changed during operation. See the TD section in this datasheet for a description of the behavior when termination is disabled. TD is internally pulled down to VSS with ~285 k Ω . Do not leave TD unconnected to ensure proper operation.
ISET	16	16	I/O	Fast Charge Current Programming Input. Connect a 590 Ω to 3 k Ω resistor from ISET to VSS to program the fast charge current level. Charging is disabled if ISET is left unconnected. While charging, the voltage ISET reflects the actual charging current and can be used to monitor charge current. See the Charge Current Translator section of this datasheet for more details.
Thermal Pad	–	--	–	There is an internal electrical connection between the exposed thermal pad and the VSS pin of the device. The thermal pad must be connected to the same potential as the VSS pin on the printed circuit board. Do not use the thermal pad as the primary ground input for the device. VSS must be connected to ground at all times.

Table 1. EN1/EN2 Settings

EN2	EN1	MAXIMUM INPUT CURRENT INTO IN
0	0	100 mA. USB100 mode
0	1	500 mA. USB500 mode
1	0	Set by external resistor from ILIM to VSS
1	1	Standby (USB suspend mode)

SIMPLIFIED BLOCK DIAGRAM

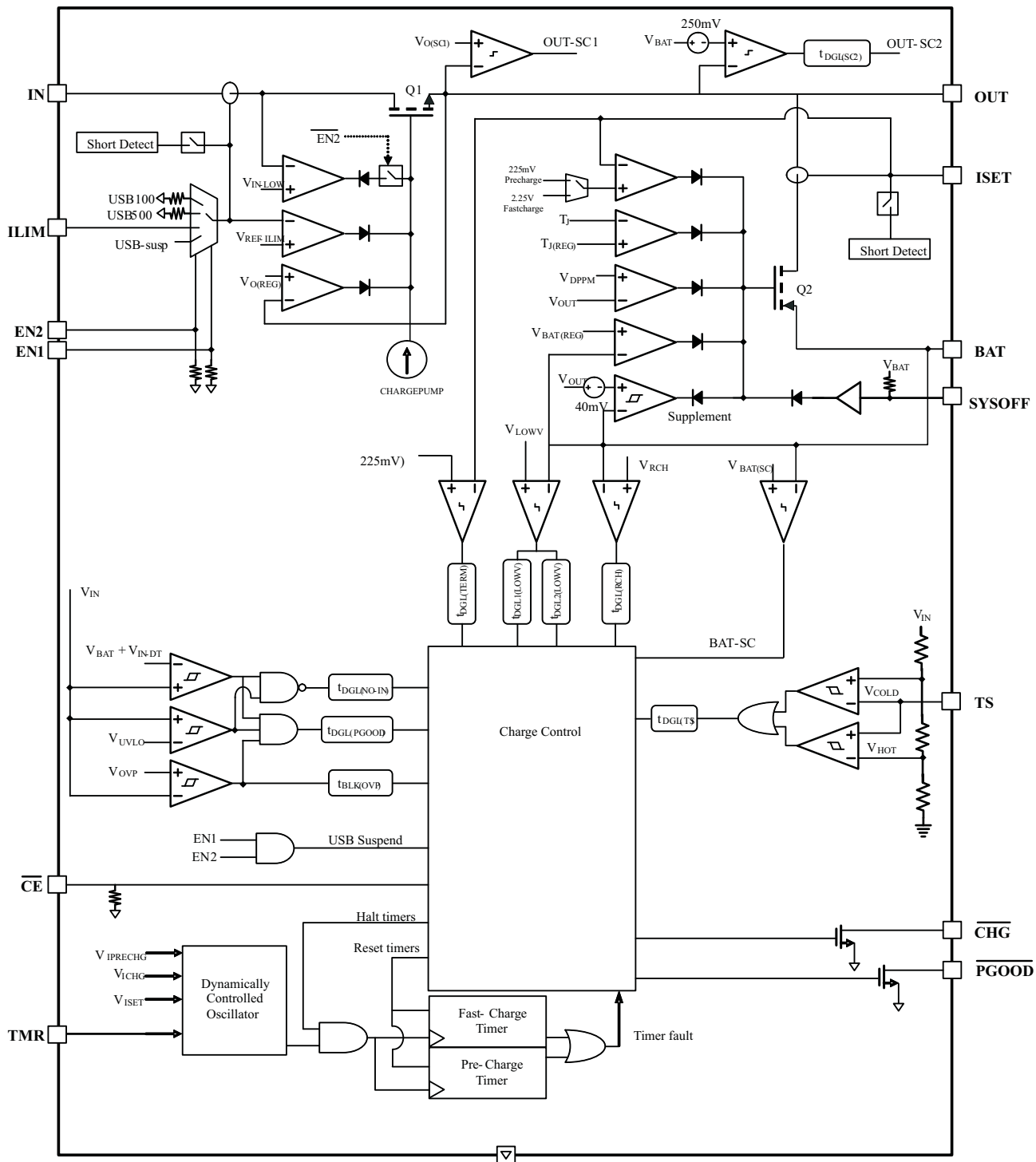

TYPICAL CHARACTERISTICS

$V_{IN} = 6V$, $EN1 = 1$, $EN2 = 0$, $T_A = 25^\circ C$, unless otherwise noted.

**ADAPTER PLUG-IN
BATTERY CONNECTED
 $R_{LOAD} = 10\Omega$**

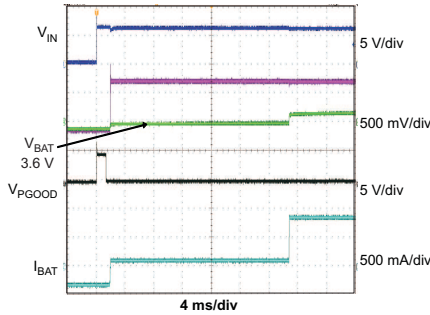

Figure 1.

**BATTERY DETECTION
BATTERY INSERTED**

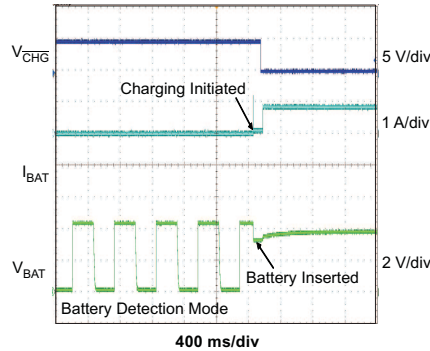

Figure 2.

**BATTERY DETECTION
BATTERY REMOVED**

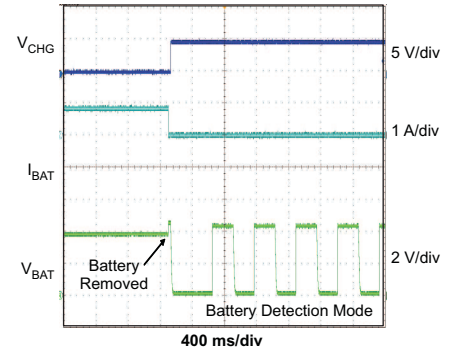

Figure 3.

**ENTERING AND EXITING
DPPM MODE
 $I_{LOAD} = 25\text{ mA TO } 250\text{ mA}$,
 $I_{CHARGE} = 300\text{ mA}$**

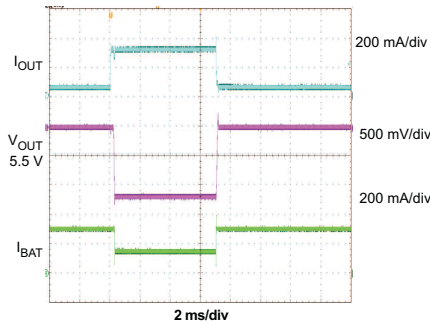

Figure 4.

**ENTERING AND EXITING BATTERY
SUPPLEMENT MODE
 $I_{LOAD} = 25\text{ mA TO } 750\text{ mA}$
bq24075T, bq24079T**

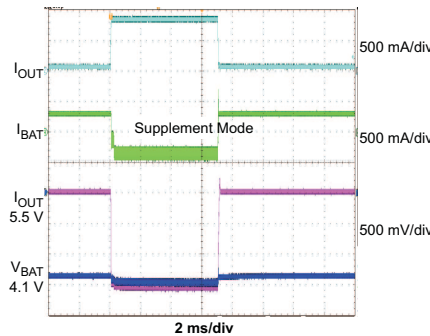

Figure 5.

**ENTERING AND EXITING BATTERY
SUPPLEMENT MODE
 $R_{LOAD} = 20\Omega \text{ TO } 4.5\Omega$
bq24072T**

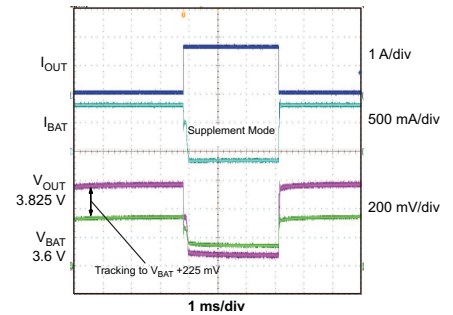

Figure 6.

CHARGER ON/OFF USING \overline{CE}

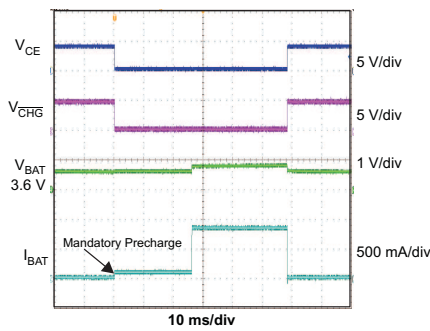

Figure 7.

**OVP FAULT
 $V_{IN} = 5.5V \text{ TO } 8.5V$**

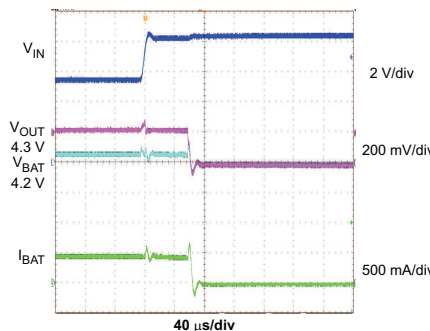

Figure 8.

**SYSTEM ON/OFF WITH INPUT
CONNECTED
 $V_{IN} = 6V$**

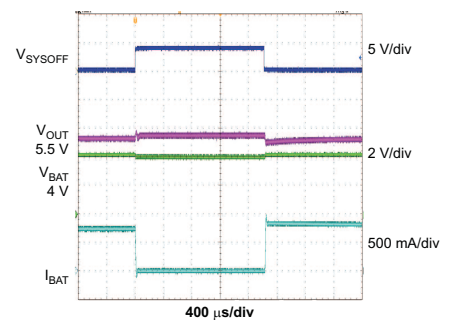

Figure 9.

TYPICAL CHARACTERISTICS (continued)

$V_{IN} = 6V$, $EN1 = 1$, $EN2 = 0$, $T_A = 25^\circ C$, unless otherwise noted.

SYSTEM ON/OFF WITH INPUT NOT CONNECTED
 $V_{IN} = 0V$

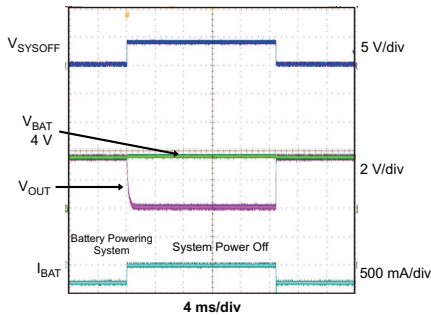

Figure 10.

THERMAL REGULATION

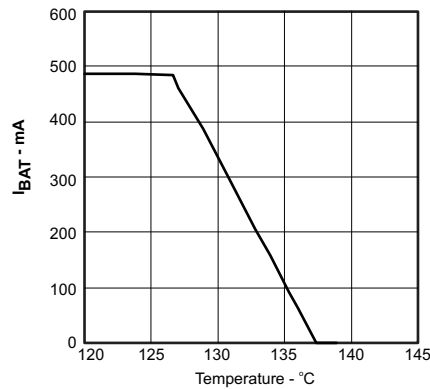

Figure 11.

DROPOUT VOLTAGE vs TEMPERATURE

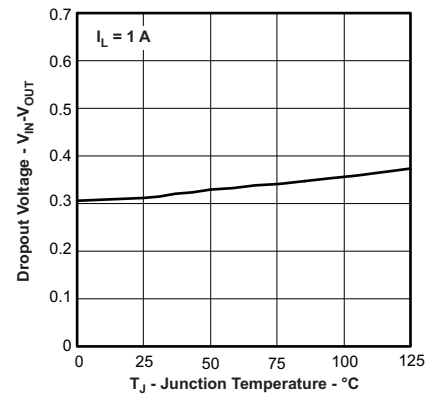

Figure 12.

DROPOUT VOLTAGE vs TEMPERATURE NO INPUT SUPPLY

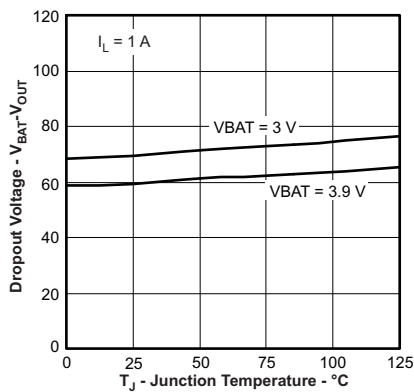

Figure 13.

bq24072T OUTPUT REGULATION vs BATTERY VOLTAGE

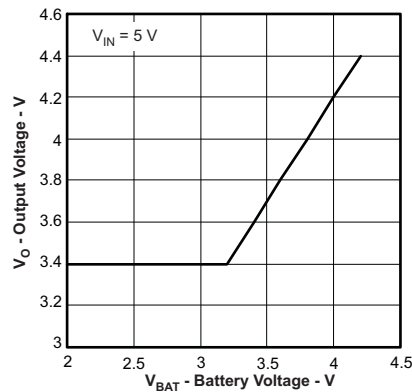

Figure 14.

bq24072T OUTPUT REGULATION vs TEMPERATURE

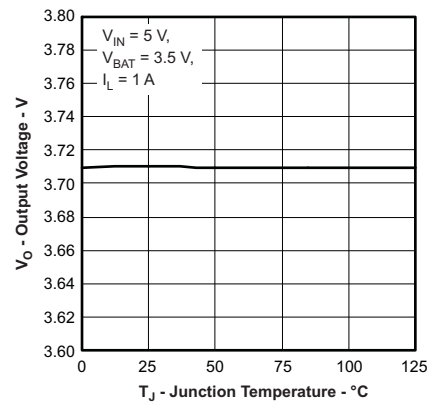

Figure 15.

TYPICAL CHARACTERISTICS (continued)

$V_{IN} = 6V$, $EN1 = 1$, $EN2 = 0$, $T_A = 25^\circ C$, unless otherwise noted.

OUTPUT REGULATION VOLTAGE
vs
TEMPERATURE

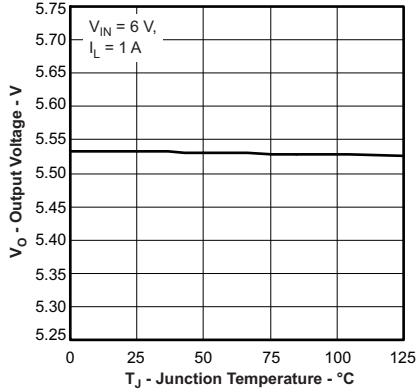

Figure 16.

BAT REGULATION VOLTAGE
vs
TEMPERATURE
bq24075T

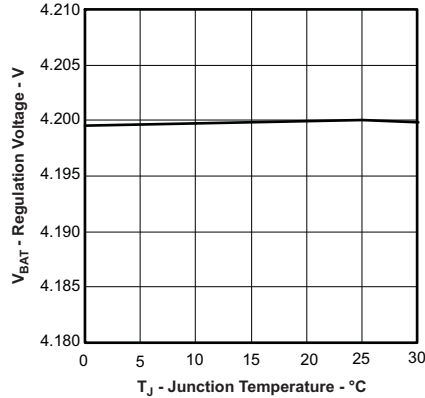

Figure 17.

BATTERY REGULATION VOLTAGE
vs
TEMPERATURE
bq24079T

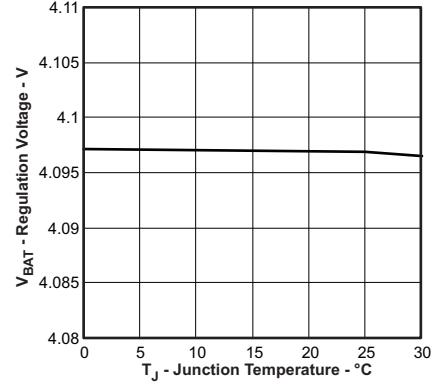

Figure 18.

OVERVOLTAGE PROTECTION
THRESHOLD
vs
TEMPERATURE

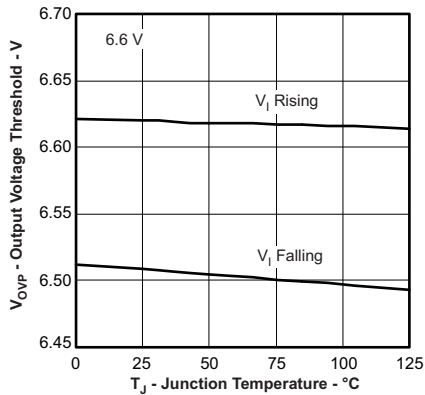

Figure 19.

INPUT CURRENT LIMIT
vs
INPUT VOLTAGE

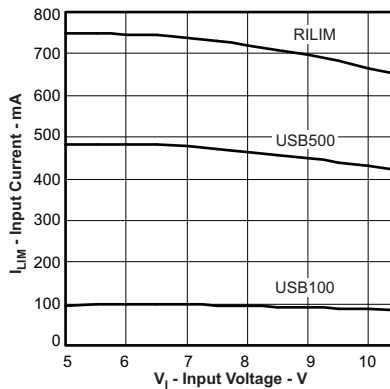

Figure 20.

FASTCHARGE CURRENT
vs
BATTERY VOLTAGE

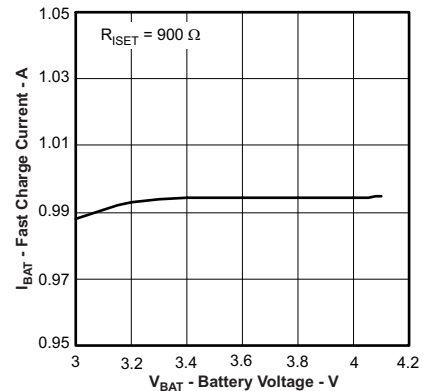

Figure 21.

TYPICAL CHARACTERISTICS (continued)

$V_{IN} = 6V$, $EN1 = 1$, $EN2 = 0$, $T_A = 25^\circ C$, unless otherwise noted.

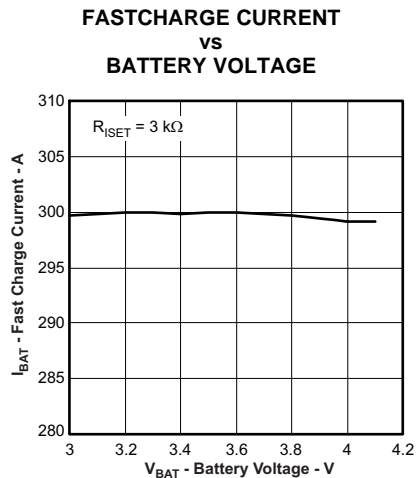

Figure 22.

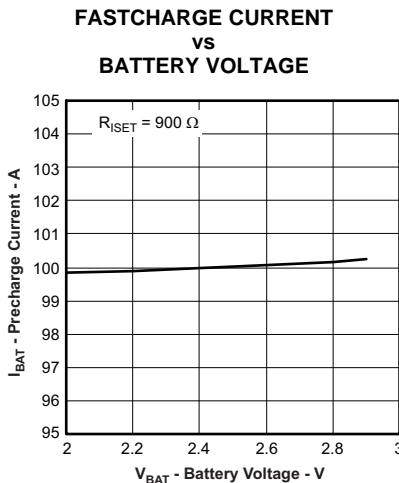

Figure 23.

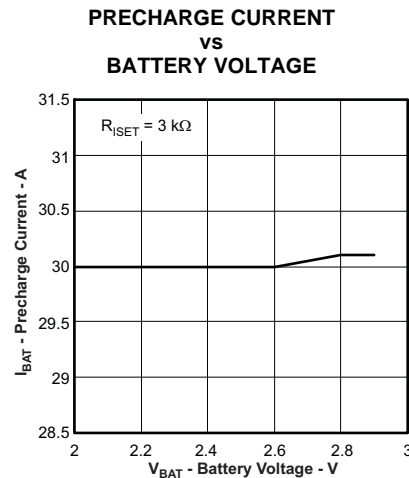
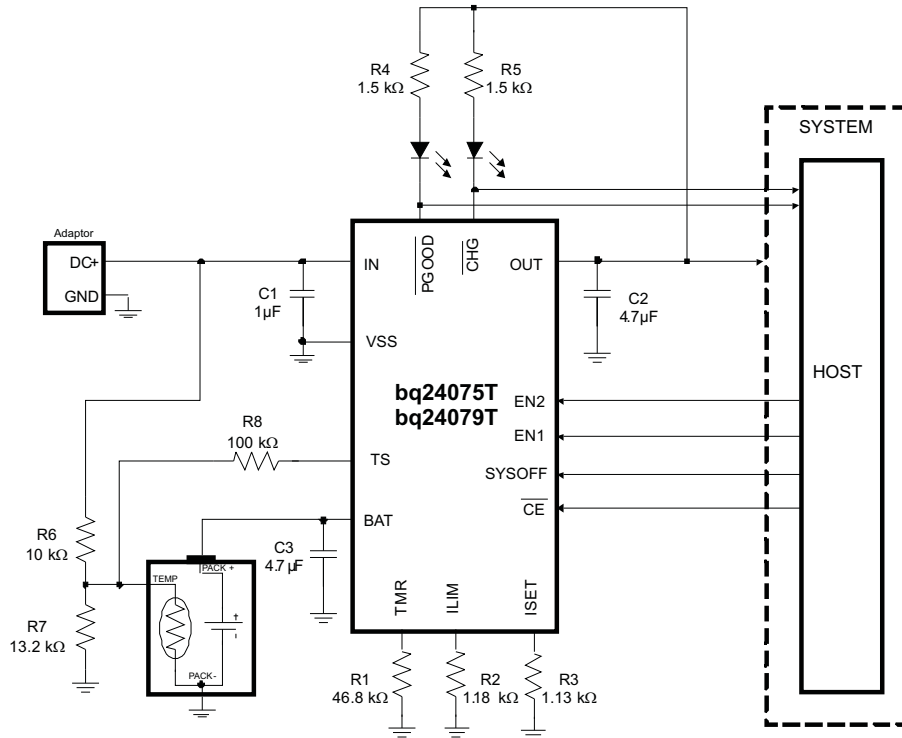

Figure 24.

APPLICATION CIRCUITS



NOTE: V_{IN} = UVLO to V_{OVP} , $I_{FASTCHG}$ = 800mA, $I_{IN(MAX)}$ = 1.35A, Battery Temperature Charge Range = 0°C to 50°C, 6.25 hour Fastcharge Safety Timer

Figure 25. Using the bq24075T/bq24079T to Disconnect the Battery from the System

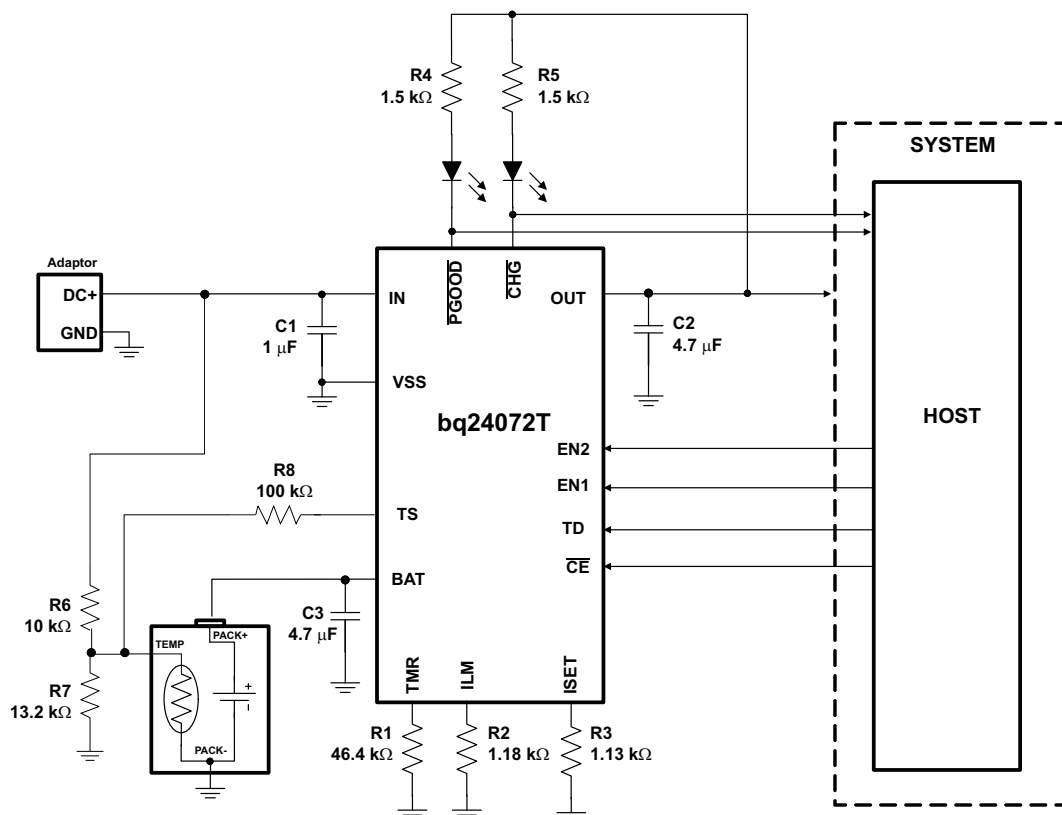

Figure 26. Using bq24072T in a Host Controlled Charger Application

DETAILED FUNCTIONAL DESCRIPTION

The bq2407x devices are integrated Li-Ion linear chargers and system power path management devices targeted at space-limited portable applications. The device powers the system while simultaneously and independently charging the battery. This feature reduces the number of charge and discharge cycles on the battery, allows for proper charge termination and enables the system to run with a defective or absent battery pack. It also allows instant system turn-on even with a totally discharged battery. The input power source for charging the battery and running the system can be an AC adaptor or a USB port. The devices feature Dynamic Power Path Management (DPPM), which shares the source current between the system and battery charging, and automatically reduces the charging current if the system load increases. When charging from a USB port, the input dynamic power management (V_{IN} -DPM) circuit reduces the input current if the input voltage falls below a threshold, preventing the USB port from crashing. The power-path architecture also permits the battery to supplement the system current requirements when the adaptor cannot deliver the peak system currents.

UNDERVOLTAGE LOCKOUT (UVLO)

The bq2407X family remains in power down mode when the input voltage at the IN pin is below the undervoltage threshold (UVLO). During the power down mode the host commands at the control inputs (\overline{CE} , EN1 and EN2) are ignored. The Q1 FET connected between IN and OUT pins is off, and the status outputs, CHG and PGOOD, are high impedance. The Q2 FET that connects BAT to OUT is ON. (If SYSOFF is high, Q2 is off). During power down mode, the VOUT(SC2) circuitry is active and monitors for overload conditions on OUT.

POWER ON

When V_{IN} exceeds the UVLO threshold, the bq2407xT powers up. While V_{IN} is below $V_{BAT} + V_{IN(DT)}$, the host commands at the control inputs (\overline{CE} , EN1 and EN2) are ignored. The Q1 FET connected between IN and OUT pins is off, and the status outputs \overline{CHG} and \overline{PGOOD} are high impedance. The Q2 FET that connects BAT to OUT is ON. (If SYSOFF is high, Q2 is off). During this mode, the $V_{OUT(SC)}$ circuitry is active and monitors for overload conditions on OUT.

Once V_{IN} rises above $V_{BAT} + V_{IN(DT)}$, \overline{PGOOD} is driven low to indicate the valid power status and the \overline{CE} , EN1, and EN2 inputs are read. The device enters standby mode if (EN1 = EN2 = HI) or if an input overvoltage condition occurs. In standby mode, Q1 is OFF and Q2 is ON so OUT is connected to the battery input. (If SYSOFF is high, FET Q2 is off). During this mode, the $V_{OUT(SC)}$ circuitry is active and monitors for overload conditions on OUT.

When the input voltage at IN is within the valid range: $V_{IN} > UVLO$ AND $V_{IN} > V_{BAT} + V_{IN(DT)}$ AND $V_{IN} < V_{OVP}$, and the EN1 and EN2 pins indicate that the USB suspend mode is not enabled [(EN1, EN2) ≠ (HI, HI)] all internal timers and other circuit blocks are activated. The device then checks for short-circuits at the ISET and ILIM pins. If no short conditions exists, the device switches on the input FET Q1 with a 100mA current limit to checks for a short circuit at OUT. When V_{OUT} is above V_{SC} , the FET Q1 switches to the current limit threshold set by EN1, EN2 and R_{ILIM} and the device enters into the normal operation. During normal operation, the system is powered by the input source (Q1 is regulating), and the device continuously monitors the status of \overline{CE} , EN1 and EN2 as well as the input voltage conditions.

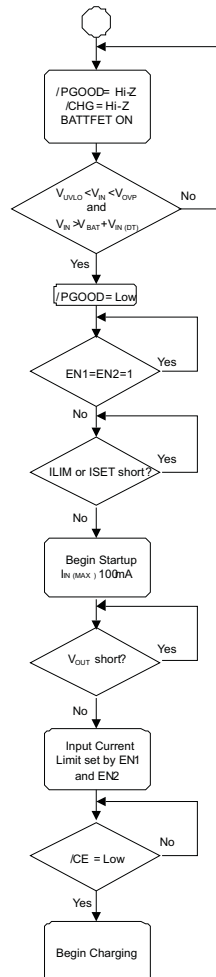

Figure 27. Startup Flow Diagram

OVERVOLTAGE PROTECTION (OVP)

The bq2407xT accepts inputs up to 28V without damage. Additionally, an overvoltage protection (OVP) circuit is implemented that shuts off the internal LDO and discontinues charging when $V_{IN} > V_{OVP}$ for a period longer than $t_{DGL(OVP)}$. When in OVP, the system output (OUT) is connected to the battery and PGOOD is high impedance. Once the OVP condition is removed, a new power on sequence starts (See the POWER ON section). The safety timers are reset and a new charge cycle will be indicated by the CHG output.

DYNAMIC POWER-PATH MANAGEMENT

The bq2407xT features an OUT output that powers the external load connected to the battery. This output is active whenever a source is connected to IN or BAT. The following sections discuss the behavior of OUT with a source connected to IN to charge the battery and a battery source only.

INPUT SOURCE CONNECTED (ADAPTER or USB)

With a source connected, the dynamic power-path management (DPPM) circuitry of the bq2407xT monitors the input current continuously. The OUT output for the bq24075T/ 79T is regulated to a fixed voltage ($V_{O(REG)}$). For the bq24072T, OUT is regulated to 225mV above the voltage at BAT. If the BAT voltage is less than 3.2V, OUT is clamped to 3.4V. This allows for proper startup of the system load even with a discharged battery. The current into IN is shared between charging the battery and powering the system load at OUT. The bq2407xT has internal selectable current limits of 100mA (USB100) and 500mA (USB500) for charging from USB ports, as well as a resistor-programmable input current limit.

The bq2407xT is USB IF compliant for the inrush current testing. The USB spec allows up to $10\mu\text{F}$ to be hard started, which establishes $50\mu\text{C}$ as the maximum inrush charge value when exceeding 100mA. The input current limit for the bq2407xT prevents the input current from exceeding this limit, even with system capacitances greater than $10\mu\text{F}$. Note that the input capacitance to the device must be selected small enough to prevent a violation ($<10\mu\text{F}$), as this current is not limited. Figure 28 demonstrates the startup of the bq2407xT and compares it to the USB-IF specification.

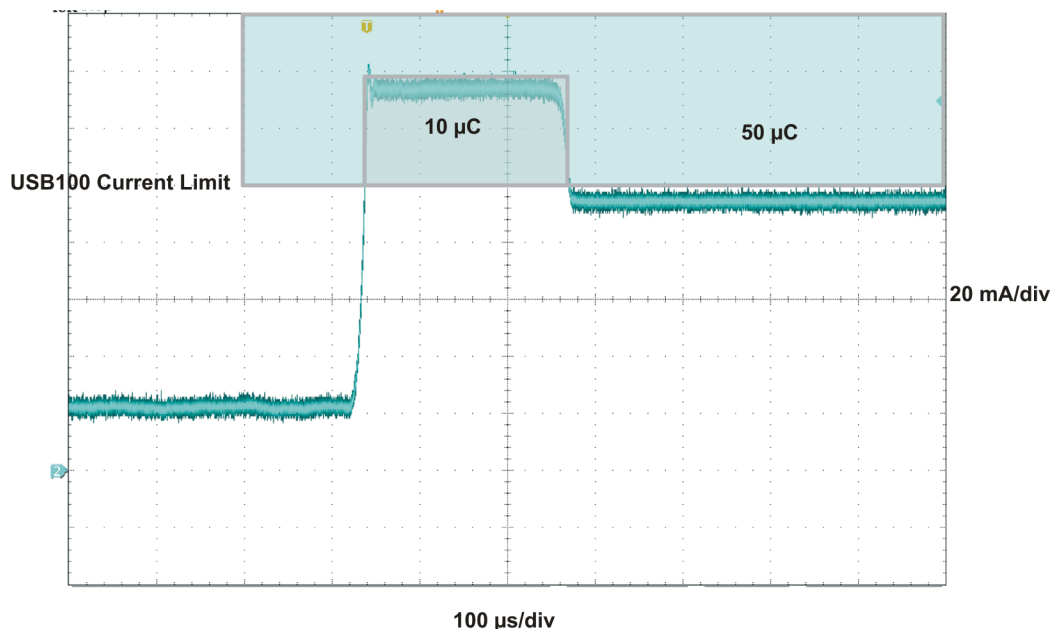

Figure 28. USB-IF Inrush Current Test

The input current limit selection is controlled by the state of the EN1 and EN2 pins as shown in Table 1. When using the resistor-programmable current limit, the input current limit is set by the value of the resistor connected from the ILIM pin to VSS, and is given by the equation:

$$I_{N-MAX} = K_{ILIM} / R_{ILIM}$$

The input current limit is adjustable up to 1.5A. The valid resistor range is 1.07 k Ω to 7.5k Ω .

When the IN source is connected, priority is given to the system load. The DPPM and Battery Supplement modes are used to maintain the system load. Figure 30 illustrates an example of the DPPM and supplement modes. These modes are explained in detail in the following sections.

Input DPM Mode (V_{IN} -DPM)

The bq2407xT utilizes the V_{IN} -DPM mode for operation from current-limited USB ports. When EN1 and EN2 are configured for USB100 (EN2=0, EN1=0) or USB500 (EN2=0, EN2=1) modes, the input voltage is monitored. If V_{IN} falls to V_{IN-DPM} , the input current limit is reduced to prevent the input voltage from falling further. This prevents the bq2407xT from crashing poorly designed or incorrectly configured USB sources. Figure 29 shows the V_{IN} -DPM behavior to a current limited source. In this figure, the input source has a 400mA current limit and the device is in USB500 mode (EN1=1, EN2=0).

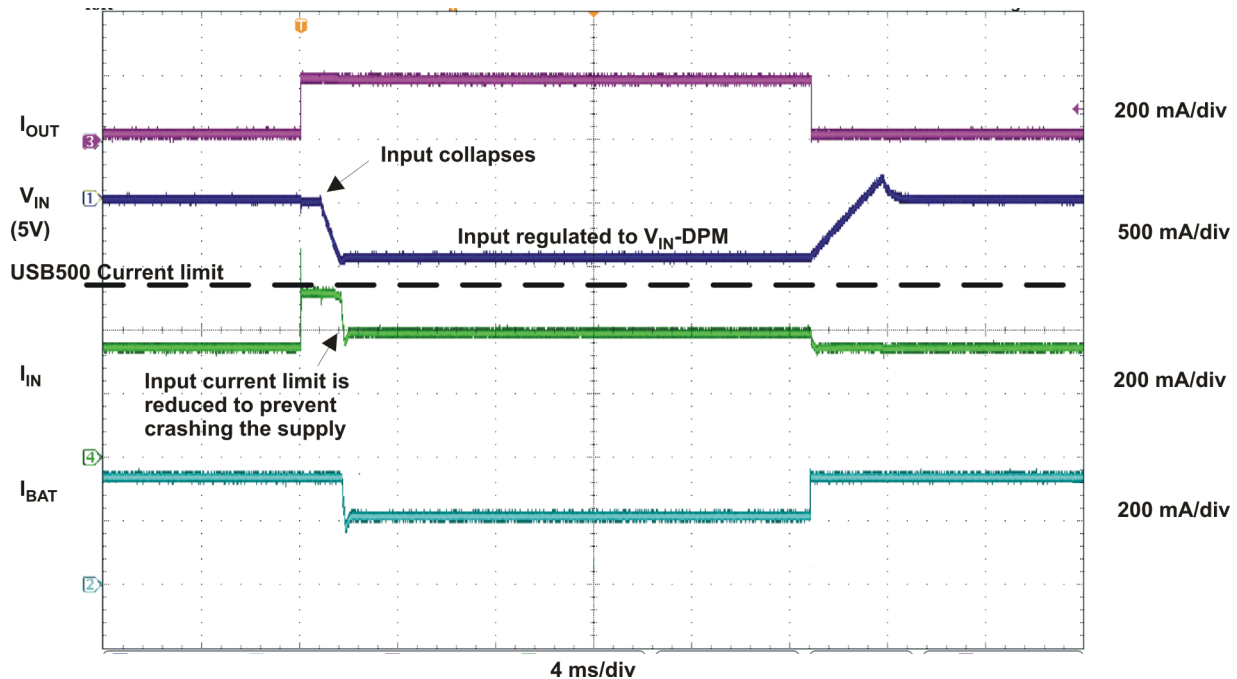

Figure 29. V_{IN} -DPM Mode

DPPM Mode

When the sum of the charging and system load currents exceeds the maximum input current (programmed with EN1, EN2 and ILIM pins), the voltage at OUT decreases. Once the voltage on the OUT pin falls to V_{DPPM} , the bq2407xT enters DPPM mode. In this mode, the charging current is reduced as the OUT current increases in order to maintain the system output. Battery termination is disabled while in DPPM mode.

Battery Supplement Mode

While in DPPM mode, if the charging current falls to zero and the system load current increases beyond the programmed input current limit, the voltage at OUT reduces further. When the OUT voltage drops below the V_{BSUP1} threshold, the battery supplements the system load. The battery stops supplementing the system load when the voltage at OUT rises above the V_{BSUP2} threshold.

During supplement mode, the battery supplement current is not regulated (BAT-FET is fully on), however there is a short circuit protection circuit built in. demonstrate supplement mode. If during battery supplement mode, the voltage at OUT drops $V_{O(SC2)}$ below the BAT voltage, the OUT output is turned off if the overload exists after $t_{DGL(SC2)}$. The short circuit recovery timer then starts counting. After $t_{REC(SC2)}$, OUT turns on and attempts to restart. If the short circuit remains, OUT is turned off and the counter restarts. Battery termination is disabled while in supplement mode.

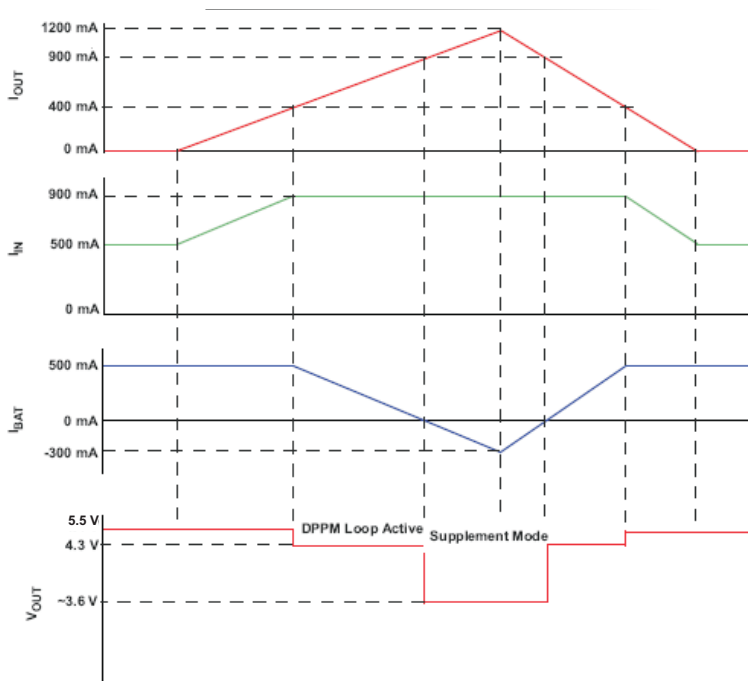

Figure 30. bq24075T, '79T DPPM and Battery Supplement Modes ($V_{OREG} = 5.5V$, $V_{BAT} = 3.6V$)

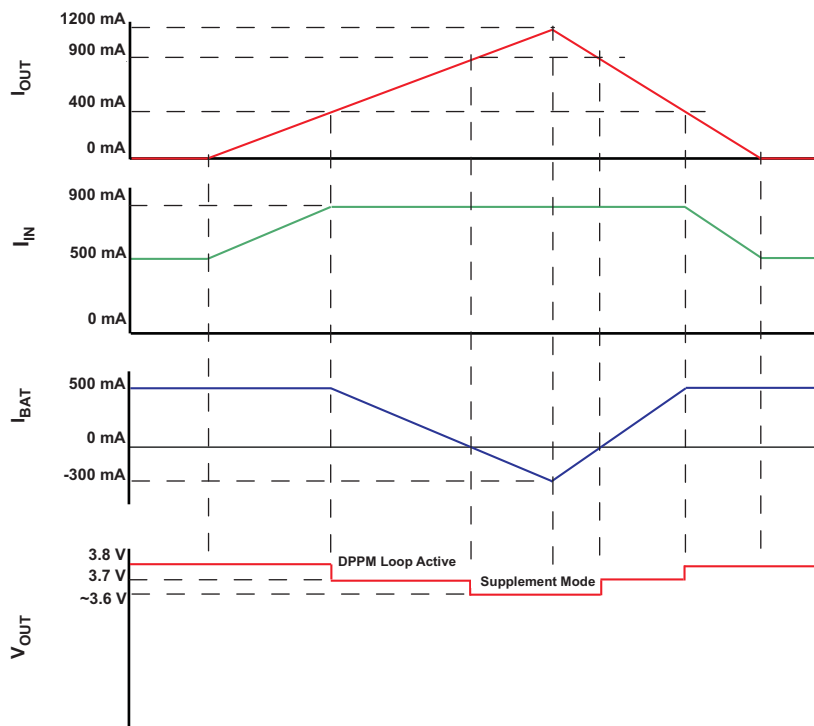

Figure 31. bq24072T DPPM and Battery Supplement Modes ($V_{OREG} = V_{BAT} + 225mV$, $V_{BAT} = 3.6V$)

INPUT SOURCE NOT CONNECTED

When no source is connected to the IN input, OUT is powered strictly from the battery. During this mode the current into OUT is not regulated, similar to Battery Supplement Mode, however the short circuit circuitry is active. If the OUT voltage falls below the BAT voltage by 250mV for longer than $t_{DGL(SC2)}$, OUT is turned off. The short circuit recovery timer then starts counting. After $t_{REC(SC2)}$, OUT turns on and attempts to restart. If the short circuit remains, OUT is turned off and the counter restarts. This ON/OFF cycle continues until the overload condition is removed.

BATTERY CHARGING

Set \overline{CE} low to initiate battery charging. First, the device checks for a short-circuit on the BAT pin by sourcing $I_{BAT(SC)}$ to the battery and monitoring the voltage. When the BAT voltage exceeds $V_{BAT(SC)}$, the battery charging continues. The battery is charged in three phases: conditioning pre-charge, constant current fast charge (current regulation) and a constant voltage tapering (voltage regulation). In all charge phases, an internal control loop monitors the IC junction temperature and reduces the charge current if an internal temperature threshold is exceeded.

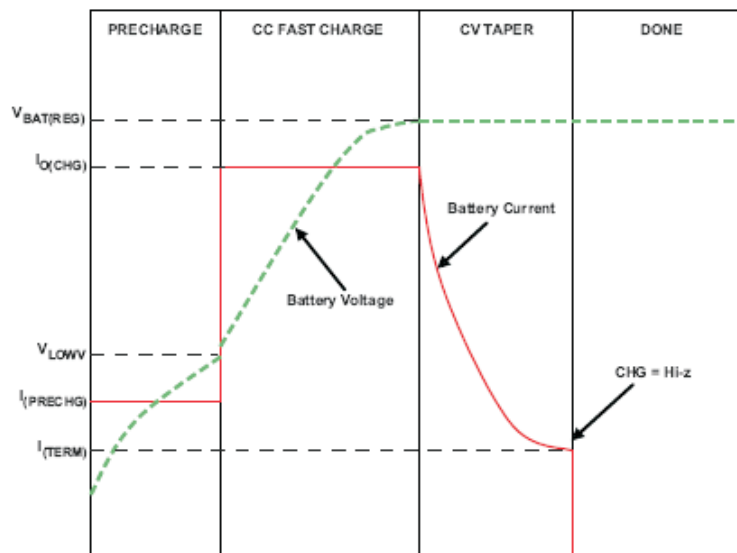

Figure 32. Typical Charging Cycle

Figure 32 illustrates a normal Li-Ion charge cycle using the bq2407xT. In the pre-charge phase, the battery is charged at with the pre-charge current (I_{PRECHG}). Once the battery voltage crosses the V_{LOWV} threshold, the battery is charged with the fast-charge current (I_{CHG}). As the battery voltage reaches $V_{BAT(REG)}$, the battery is held at a constant voltage of $V_{BAT(REG)}$ and the charge current tapers off as the battery approaches full charge. When the battery current reaches I_{TERM} , the CHG pin indicates *charging done* by going high-impedance.

Note that termination detection is disabled whenever the charge rate is reduced because of the actions of the thermal loop, the DPPM loop or the V_{IN-DPM} loop.

The value of the fast-charge current is set by the resistor connected from the ISET pin to VSS, and is given by the equation

$$I_{CHG} = K_{ISET} / R_{ISET}$$

The charge current limit is adjustable up to 1.5A. The valid resistor range is 590Ω to 3 kΩ. Note that if I_{CHG} is programmed as greater than the input current limit, the battery will not charge at the rate of I_{CHG} , but at the slower rate of $I_{IN(MAX)}$ (minus the load current on the OUT pin, if any). In this case, the charger timers will be proportionately slowed down.

CHARGE CURRENT TRANSLATOR

When the charger is enabled, internal circuits generate a current proportional to the charge current at the ISET input. The current out of ISET is 1/400 (±10%) of the charge current. This current, when applied to the external charge current programming resistor, R_{ISET}, generates an analog voltage that can be monitored by an external host to calculate the current sourced from BAT.

$$V_{ISET} = I_{CHARGE} / 400 \times R_{ISET}$$

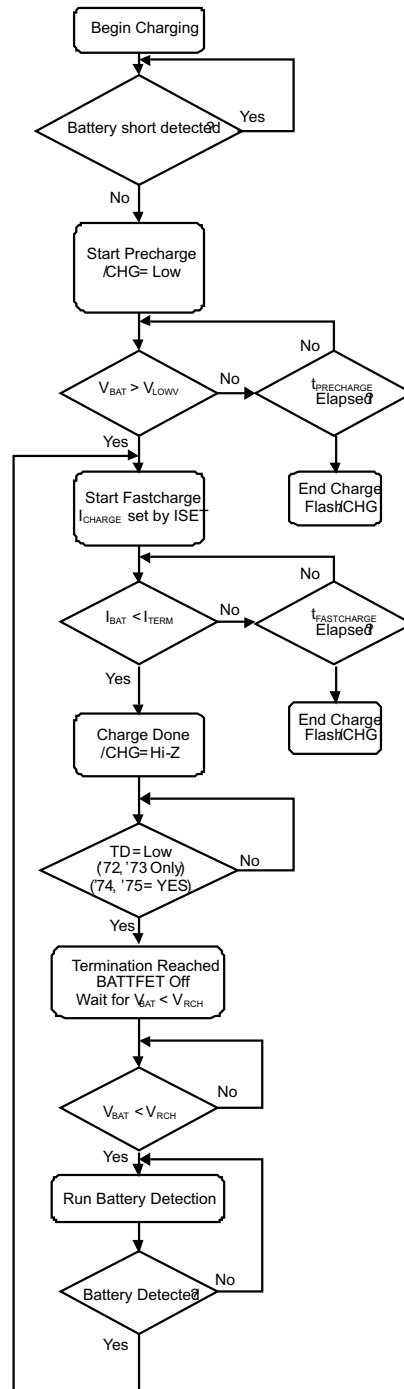

Figure 33. Battery Charging Flow Diagram

BATTERY DETECTION AND RECHARGE

The bq2407xT automatically detects if a battery is connected or removed. Once a charge cycle is complete, the battery voltage is monitored. When the battery voltage falls below V_{RCH} , the battery detection routine is run. During battery detection, current ($I_{BAT(DET)}$) is pulled from the battery for a duration t_{DET} to see if the voltage on BAT falls below V_{LOWV} . If not, charging begins. If it does, then it indicates that the battery is missing or the protector is open. Next, the precharge current is applied for t_{DET} to close the protector if possible. If $V_{BAT} < V_{RCH}$, then the protector is closed and charging is initiated. If $V_{BAT} > V_{RCH}$, then the battery is determined to be missing and the detection routine continues.

TERMINATION DISABLE (TD Input, bq24072T)

The bq24072T contains a TD input that allows termination to be enabled/ disabled. Connect TD to a logic high to disable charge termination. When termination is disabled, the device goes through the pre-charge, fast-charge and CV phases, then remains in the CV phase. During the CV phase, the charger maintains the output voltage at BAT equal to $V_{BAT(REG)}$, and charging current does not terminate. The charge current is set by I_{CHG} or I_{INmax} , whichever is less. Battery detection is not performed. The \overline{CHG} output is high impedance once the current falls below I_{TERM} and does not go low until the input power or \overline{CE} are toggled. When termination is disabled, the pre-charge and fast-charge safety timers are also disabled.

BATTERY DISCONNECT (SYSOFF Input)

The bq24075T and bq24079T feature a SYSOFF input that allows the user to turn the FET Q2 off and disconnect the battery from the OUT pin. This is useful for disconnecting the system load from the battery, factory programming where the battery is not installed or for host side impedance track fuel gauging, such as bq27500, where the battery open circuit voltage level must be detected before the battery charges or discharges. The \overline{CHG} output remains low when SYSOFF is high. Connect SYSOFF to VSS, to turn Q2 on for normal operation. SYSOFF is internally pulled to VBAT through ~5 M Ω resistor.

DYNAMIC CHARGE TIMERS (TMR Input)

The bq2407xT devices contain internal safety timers for the pre-charge and fast-charge phases to prevent potential damage to the battery and the system. The timers begin at the start of the respective charge cycles. The timer values are programmed by connecting a resistor from TMR to VSS. The resistor value is calculated using the following equation:

$$t_{PRECHG} = K_{TMR} \times R_{TMR}$$

$$t_{MAXCHG} = 10 \times K_{TMR} \times R_{TMR}$$

Leave TMR unconnected to select the internal default timers. Disable the timers by connecting TMR to VSS.

Note that timers are suspended when the device is in thermal shutdown, and the timers are slowed proportionally to the charge current when the device enters thermal regulation.

1. During the fast charge phase, several events increase the timer durations.
2. The system load current activates the DPPM loop which reduces the available charging current
3. The input current is reduced because the input voltage has fallen to V_{IN-DPM}
4. The device has entered thermal regulation because the IC junction temperature has exceeded $T_{J(REG)}$

During each of these events, the internal timers are slowed down proportionately to the reduction in charging current. For example, if the charging current is reduced by half for two minutes, the timer clock is reduced to half the frequency and the counter counts half as fast resulting in only one minute of "counting" time.

If the precharge timer expires before the battery voltage reaches V_{LOWV} , the bq2407xT indicates a fault condition. Additionally, if the battery current does not fall to I_{TERM} before the fast charge timer expires, a fault is indicated. The \overline{CHG} output flashes at approximately 2 Hz to indicate a fault condition. The fault condition is cleared by toggling \overline{CE} or the input power, entering/ exiting USB suspend mode, or an OVP event.

STATUS INDICATORS (\overline{PGOOD} , \overline{CHG})

The bq2407xT contains two open-drain outputs that signal its status. The \overline{PGOOD} output signals when a valid input source is connected. \overline{PGOOD} is low when $(V_{BAT} + V_{IN(DT)}) < V_{IN} < V_{OVP}$. When the input voltage is outside of this range, \overline{PGOOD} is high impedance.

The charge cycle after power-up, \overline{CE} going low, or exiting OVP is indicated with the \overline{CHG} output on (low - LED on), whereas all refresh (subsequent) charges will result in the \overline{CHG} output off (open – LED off). In addition, the \overline{CHG} signals timer faults by flashing at approximately 2Hz.

Table 2. \overline{PGOOD} Status Indicator

INPUT STATE	\overline{PGOOD} OUTPUT
$V_{IN} < V_{UVLO}$	Hi impedance
$V_{UVLO} < V_{IN} < V_{IN(DT)}$	Hi impedance
$V_{IN(DT)} < V_{IN} < V_{OVF}$	Low
$V_{IN} < V_{OVF}$	Hi impedance

Table 3. \overline{CHG} Status Indicator

CHARGE STATE	\overline{CHG} OUTPUT
Charging	Low (for first charge cycle)
Charging suspended by thermal loop, or DPPM loop	
Safety timers expired	Flashing at 2 Hz
Charging done	Hi impedance
Recharging after termination	
IC disabled or no valid input power	
Battery absent	

THERMAL REGULATION AND THERMAL SHUTDOWN

The bq2407xT contain a thermal regulation loop that monitors the die temperature. If the temperature exceeds $T_{J(REG)}$, the device automatically reduces the charging current to prevent the die temperature from increasing further. In some cases, the die temperature continues to rise despite the operation of the thermal loop, particularly under high V_{IN} and heavy OUT system load conditions. Under these conditions, if the die temperature increases to $T_{J(OFF)}$, the input FET Q1 is turned OFF. FET Q2 is turned ON to ensure that the battery still powers the load on OUT. Once the device die temperature cools by $T_{J(OFF-HYS)}$, the input FET Q1 is turned on and the device returns to thermal regulation. Continuous overtemperature conditions result in a "hiccup" mode. During thermal regulation, the safety timers are slowed down proportionately to the reduction in current limit.

Note that this feature monitors the die temperature of the bq2407xT. This is not synonymous with ambient temperature. Self heating exists due to the power dissipated in the IC because of the linear nature of the battery charging algorithm and the LDO associated with OUT. A modified charge cycle with the thermal loop active is shown in [Figure 34](#). Battery termination is disabled during thermal regulation.

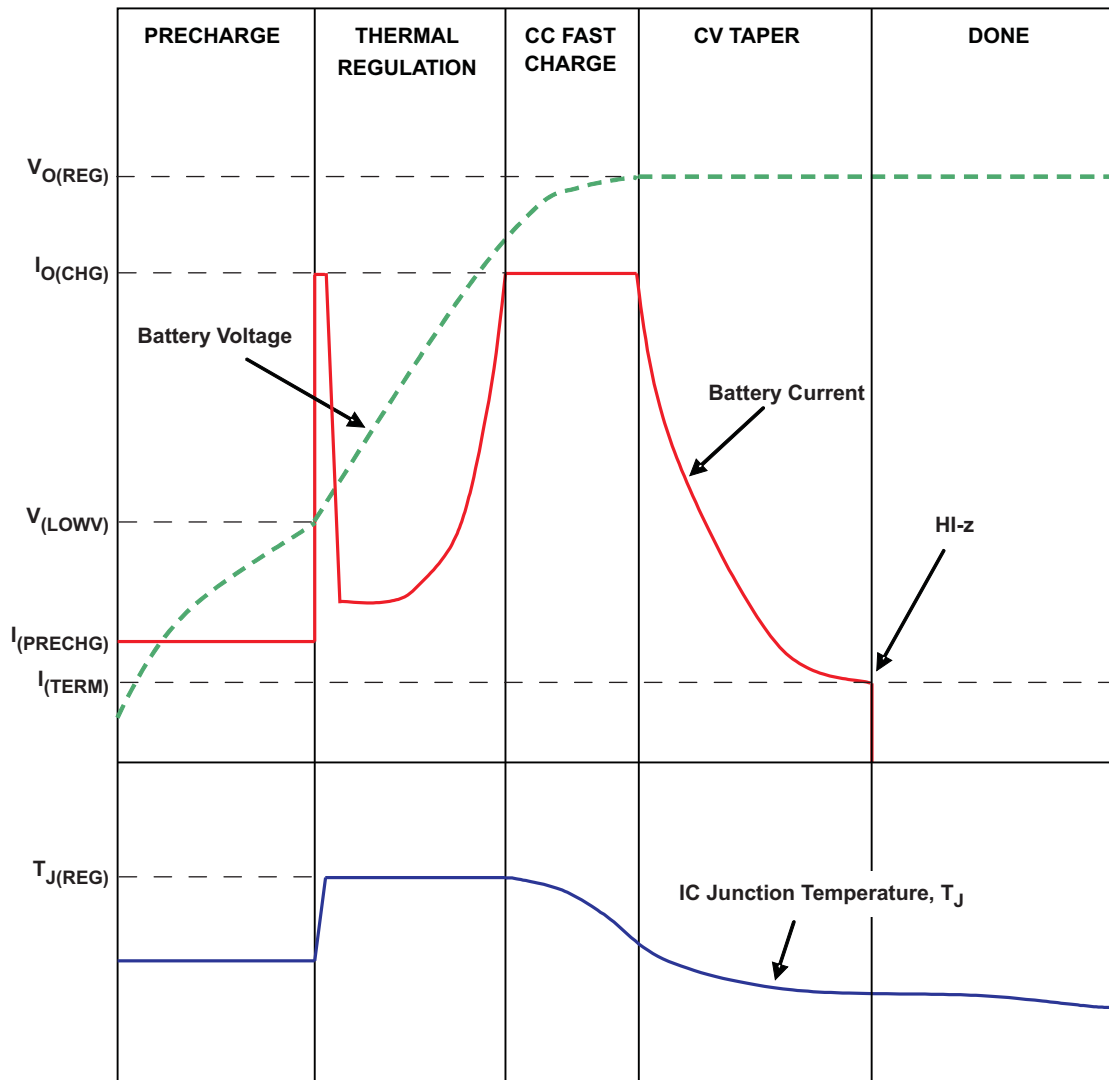

Figure 34. Charge Cycle Modified by Thermal Loop

BATTERY PACK TEMPERATURE MONITORING

The bq2407xT features an external battery pack temperature monitoring input. The TS input connects to the NTC thermistor in the battery pack to monitor battery temperature and prevent dangerous over-temperature conditions. During charging, the voltage at TS is continuously monitored. If, at any time, the voltage at TS is outside of the operating range (V_{COLD} to V_{HOT}), charging is suspended. The timers maintain their values but suspend counting. When the voltage measured at TS returns to within the operation window, charging is resumed and the timers continue counting. When charging is suspended due to a battery pack temperature fault, the \overline{CHG} output remains low and continues to indicate charging.

$$R6 = \frac{\frac{V_{IN}}{V_{COLD}} - 1}{\frac{1}{R7} + \frac{1}{RCOLD}} \quad (1)$$

$$R7 = \frac{V_{IN} \times R_{COLD} \times R_{HOT} \times \left[\frac{1}{V_{COLD}} - \frac{1}{V_{HOT}} \right]}{R_{HOT} \times \left[\frac{V_{IN}}{V_{HOT}} - 1 \right] - R_{COLD} \times \left[\frac{V_{IN}}{V_{COLD}} - 1 \right]} \quad (2)$$

Where:

$$V_{COLD} = 0.25 \times V_{IN}$$

$$V_{HOT} = 0.125 \times V_{IN}$$

RHOT is the expected thermistor resistance at the programmed hot threshold, RCOLD is the expected thermistor resistance at the programmed cold threshold. If the value of R6 is less than 100kΩ, R3 must be added to protect the IC from 28V inputs. If R6 is greater than 100kΩ, R8 does not need to be used.

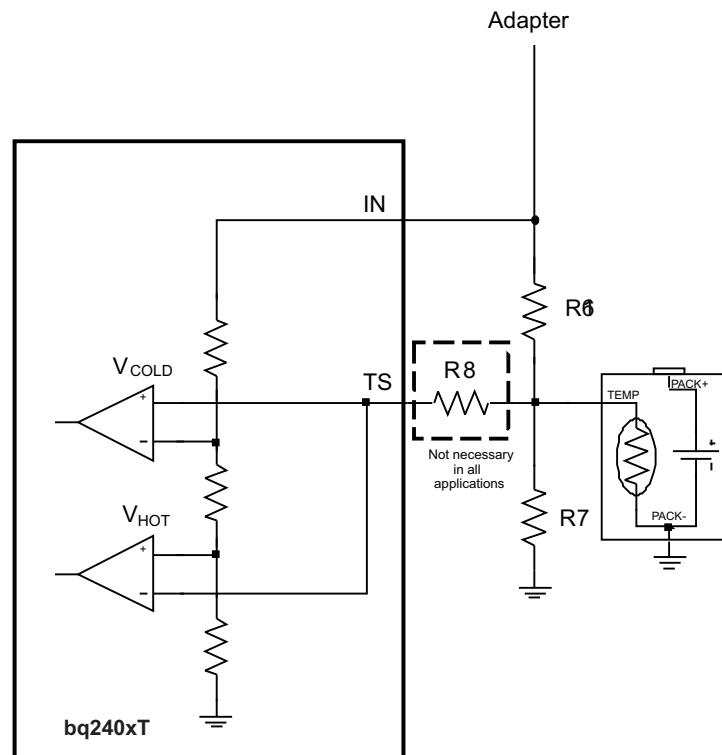

Figure 35. NTC Monitoring Function

For applications that do not require the TS monitoring function, set R6 = 200kΩ and R7 = 49.9kΩ to set the TS voltage at a valid level and maintain charging.

APPLICATION INFORMATION

bq2407xT CHARGER DESIGN EXAMPLE

Refer to Typical Application Circuits for Schematics of the Design Example.

Supply voltage = 5V

Fast charge current of approximately 800 mA; ISET – pin 16

Input Current Limit = 1.35A; ILIM – pin 12

Safety timer duration, Fast-Charge = 6.25 hours; TMR – pin 14

Battery Temperature Sense = 10kΩ; NTC (103AT-2), 0°C to 50°C Operation

Program the Fast Charge Current (ISET):

$$R_{ISET} = K_{ISET} / I_{CHG}$$

$K_{ISET} = 890 \text{ A}\Omega$; from the electrical characteristics table

$$R_{ISET} = 890 \text{ A}\Omega / 0.8 \text{ A} = 1.1125 \text{ k}\Omega$$

Select the closest standard value, which for this case is 1.13kΩ. Connect this resistor between ISET (pin 16) and V_{SS} .

Program the Input Current Limit (ILIM)

$$R_{ILIM} = K_{ILIM} / I_{IN(MAX)}$$

$K_{ILIM} = 1600 \text{ A}\Omega$; from the electrical characteristics table.

$$R_{ISET} = 1600 \text{ A}\Omega / 1.35 \text{ A} = 1.19 \text{ k}\Omega$$

Select the closest standard value, which for this case is 1.18 kΩ. Connect this resistor between ILIM (pin 12) and V_{SS} .

Program 6.25-hour Fast-Charge Safety Timer (TMR)

$$R_{TMR} = t_{MAXCHG} / (10 \times K_{TMR})$$

$K_{TMR} = 45 \text{ s/k}\Omega$ from the electrical characteristics table.

$$R_{TMR} = (6.25 \text{ hr} \times 3600 \text{ s/hr}) / (10 \times 45 \text{ s/k}\Omega) = 46.8 \text{ k}\Omega$$

Select the closest standard value, which for this case is 46.4 kΩ. Connect this resistor between TMR (pin 2) and V_{SS} .

TS Function

Using a 10kΩ NTC thermistor in the battery pack (103AT-2). Connect a resistor divider from V_{IN} to V_{SS} with the thermistor and TS connected to the center tap (R6 and R7 in typical application circuits).

$R_{HOT} = 4.086 \text{ k}\Omega$; 50°C threshold from NTC data sheet

$R_{COLD} = 28.16 \text{ k}\Omega$; 0°C threshold from NTC data sheet

$$V_{COLD} = 0.25 \times V_{IN} = 0.25 \times 5 \text{ V} = 1.25 \text{ V}$$

$$V_{HOT} = 0.125 \times V_{IN} = 0.125 \times 5 \text{ V} = 0.625 \text{ V}$$

$$R7 = \frac{V_{IN} \times R_{COLD} \times R_{HOT} \times \left[\frac{1}{V_{COLD}} - \frac{1}{V_{HOT}} \right]}{R_{HOT} \times \left[\frac{V_{IN}}{V_{HOT}} - 1 \right] - R_{COLD} \times \left[\frac{V_{IN}}{V_{COLD}} - 1 \right]} = \frac{5 \times 28160 \times 4086 \times \left[\frac{1}{1.25} - \frac{1}{0.625} \right]}{4086 \times \left[\frac{5}{0.625} - 1 \right] - 28160 \times \left[\frac{5}{1.25} - 1 \right]} = 8.236 \text{ k}\Omega \quad (3)$$

$$R6 = \frac{\frac{V_{IN}}{V_{COLD}} - 1}{\frac{1}{R7} + \frac{1}{R_{COLD}}} = \frac{\frac{5}{1.25} - 1}{\frac{1}{8250} + \frac{1}{28160}} = 19.14 \text{ k}\Omega \quad (4)$$

Since the calculated values for R6 is less than 100kΩ, a 100kΩ resistor for R8 must be used. Choose the closest standard values, which for this case are R6=8.25kΩ and R7 = 19.1kΩ.

For applications that do not require the TS monitoring function, set R6 = 200kΩ and R7 = 49.9kΩ to set the TS voltage at a valid level and maintain charging.

CHG and PGOOD LED Status: connect a 1.5kΩ resistor in series with a LED between $\overline{\text{OUT}}$ and $\overline{\text{CHG}}$ to indicate charging status. Connect a 1.5kΩ resistor in series with a LED between OUT and PGOOD to indicate when a valid input source is connected.

Processor Monitoring Status: connect a pullup resistor (on the order of 100 kΩ) between the processor power rail and CHG and PGOOD

Termination Disable: connect TD high to disable termination. Connect TD low to enable termination.

System ON/OFF (SYSOFF): Connect SYSOFF high to disconnect the battery from the system load. Connect SYSOFF low for normal operation.

SELECTING IN, OUT AND BAT CAPACITORS

In most applications, all that is needed is a high-frequency decoupling capacitor (ceramic) on the power pin, input, output and battery pins. Using the values shown on the application diagram, is recommended. After evaluation of these voltage signals with real system operational conditions, one can determine if capacitance values can be adjusted toward the minimum recommended values (DC load application) or higher values for fast high amplitude pulsed load applications. Note if designed high input voltage sources (bad adapters or wrong adapters), the capacitor needs to be rated appropriately. Ceramic capacitors are tested to 2x their rated values so a 16V capacitor may be adequate for a 30V transient (verify tested rating with capacitor manufacturer).

THERMAL PACKAGE

The bq2407xT family is packaged in a thermally enhanced MLP package. The package includes a thermal pad to provide an effective thermal contact between the IC and the printed circuit board (PCB). The power pad should be directly connected to V_{SS} . Full PCB design guidelines for this package are provided in the application note entitled: QFN/SON PCB Attachment Application Note. The most common measure of package thermal performance is thermal impedance (θ_{JA}) measured (or modeled) from the chip junction to the air surrounding the package surface (ambient).

The mathematical expression for θ_{JA} is: $\theta_{JA} = (T_J - T) / P$

Where:

T_J = chip junction temperature

T = ambient temperature

P = device power dissipation

Factors that can influence the measurement and calculation of θ_{JA} include

Whether or not the device is board mounted

Trace size, composition, thickness, and geometry

Orientation of the device (horizontal or vertical)

Volume of the ambient air surrounding the device under test and airflow

Whether other surfaces are in close proximity to the device being tested

Due to the charge profile of Li-Ion batteries the maximum power dissipation is typically seen at the beginning of the charge cycle when the battery voltage is at its lowest. Typically after fast charge begins the pack voltage increases to 3.4V within the first 2 minutes. The thermal time constant of the assembly typically takes a few minutes to heat up so when doing maximum power dissipation calculations, 3.4V is a good minimum voltage to use. This is verified, with the system and a fully discharged battery, by plotting temperature on the bottom of the PCB under the IC (pad should have multiple vias), the charge current and the battery voltage as a function of time. The fast charge current will start to taper off if the part goes into thermal regulation.

The device power dissipation, P , is a function of the charge rate and the voltage drop across the internal PowerFET. It can be calculated from [Equation 5](#) when a battery pack is being charged :

$$P = [V_{IN} - V_{OUT}] \times I_{OUT} + [V_{OUT} - V_{BAT}] \times I_{BAT} \quad (5)$$

The thermal loop feature reduces the charge current to limit excessive IC junction temperature. It is recommended that the design not run in thermal regulation for typical operating conditions (nominal input voltage and nominal ambient temperatures) and use the feature for non typical situations such as hot environments or higher than normal input source voltage. With that said, the IC will still perform as described, if the thermal loop is always active.

Half-Wave Adapters

Some adapters implement a half rectifier topology, which causes the adapter output voltage to fall below the battery voltage during part of the cycle. To enable operation with adapters under those conditions, the bq2407xT family keeps the charger on for at least 20 msec (typical) after the input power puts the part in sleep mode. This feature enables use of external adapters using 50 Hz networks. The input must not drop below the UVLO voltage for the charger to work properly. Thus, the battery voltage should be above the UVLO to help prevent the input from dropping out. Additional input capacitance may be needed.

When the input is between V_{UVLO} and $V_{IN(DT)}$, the device enters sleep mode. After entering sleep mode for 20ms the internal FET connection between the IN and OUT pin is disabled and pulling the input to ground will not discharge the battery, other than the leakage on the BAT pin. If one has a full 1000mAh battery and the leakage is $10\mu A$, then it would take $1000mAh/10\mu A = 100000$ hours (11.4 years) to discharge the battery. The battery's self discharge is typically 5 times higher than this

Layout Tips

1. To obtain optimal performance, the decoupling capacitor from IN to GND (thermal pad) and the output filter capacitors from OUT to GND (thermal pad) should be placed as close as possible to the bq2407xT, with short trace runs to both IN, OUT and GND (thermal pad).
2. All low-current GND connections should be kept separate from the high-current charge or discharge paths from the battery. Use a single-point ground technique incorporating both the small signal ground path and the power ground path.
3. The high current charge paths into IN pin and from the OUT pin must be sized appropriately for the maximum charge current in order to avoid voltage drops in these traces

The bq2407xT family is packaged in a thermally enhanced MLP package. The package includes a thermal pad to provide an effective thermal contact between the IC and the printed circuit board (PCB); this thermal pad is also the main ground connection for the device. Connect the thermal pad to the PCB ground connection. Full PCB design guidelines for this package are provided in the application note entitled: QFN/SON PCB Attachment Application Note.

REVISION HISTORY

Note: Page numbers of current version may differ from previous versions.

Changes from Original (December 2009) to Revision A	Page
• Added bq24072T device to data sheet header	1
• Added bq24072T feature bullet	1
• Added "bq24072T" to graphic entity	1
• Added bq24072T spec. to Ordering Info table	2
• Added bq24072T to $V_{O(REG)}$ Elec. Char. spec.	4
• Added bq24072T to V_{DPPM} Elec. Char. spec.	4
• Added "bq24072T" to $V_{BAT(REG)}$ Elec. Char. spec.	5
• Added bq24072T Pin Diagram	7
• Added graphic entity for bq24072T Host Controlled Charger application	15
• Added graphic entity for bq24072T DPPM and Battery Supplement Modes	19
• Added bq24072T Termination Disable (TD) description	22
• Added Termination Disable operation procedure.	27

PACKAGING INFORMATION

Orderable Device	Status (1)	Package Type	Package Drawing	Pins	Package Qty	Eco Plan (2)	Lead/Ball Finish	MSL Peak Temp (3)	Op Temp (°C)	Top-Side Markings (4)	Samples
BQ24072TRGTR	ACTIVE	QFN	RGT	16	3000	Green (RoHS & no Sb/Br)	CU NIPDAU	Level-2-260C-1 YEAR	-40 to 85	PAP	Samples
BQ24072TRGTT	ACTIVE	QFN	RGT	16	250	Green (RoHS & no Sb/Br)	CU NIPDAU	Level-2-260C-1 YEAR	-40 to 85	PAP	Samples
BQ24075TRGTR	ACTIVE	QFN	RGT	16	3000	Green (RoHS & no Sb/Br)	CU NIPDAU	Level-2-260C-1 YEAR	-40 to 85	OEC	Samples
BQ24075TRGTT	ACTIVE	QFN	RGT	16	250	Green (RoHS & no Sb/Br)	CU NIPDAU	Level-2-260C-1 YEAR	-40 to 85	OEC	Samples
BQ24079TRGTR	ACTIVE	QFN	RGT	16	3000	Green (RoHS & no Sb/Br)	CU NIPDAU	Level-2-260C-1 YEAR	-40 to 85	OED	Samples
BQ24079TRGTT	ACTIVE	QFN	RGT	16	250	Green (RoHS & no Sb/Br)	CU NIPDAU	Level-2-260C-1 YEAR	-40 to 85	OED	Samples

(1) The marketing status values are defined as follows:

ACTIVE: Product device recommended for new designs.

LIFEBUY: TI has announced that the device will be discontinued, and a lifetime-buy period is in effect.

NRND: Not recommended for new designs. Device is in production to support existing customers, but TI does not recommend using this part in a new design.

PREVIEW: Device has been announced but is not in production. Samples may or may not be available.

OBSOLETE: TI has discontinued the production of the device.

(2) Eco Plan - The planned eco-friendly classification: Pb-Free (RoHS), Pb-Free (RoHS Exempt), or Green (RoHS & no Sb/Br) - please check <http://www.ti.com/productcontent> for the latest availability information and additional product content details.

TBD: The Pb-Free/Green conversion plan has not been defined.

Pb-Free (RoHS): TI's terms "Lead-Free" or "Pb-Free" mean semiconductor products that are compatible with the current RoHS requirements for all 6 substances, including the requirement that lead not exceed 0.1% by weight in homogeneous materials. Where designed to be soldered at high temperatures, TI Pb-Free products are suitable for use in specified lead-free processes.

Pb-Free (RoHS Exempt): This component has a RoHS exemption for either 1) lead-based flip-chip solder bumps used between the die and package, or 2) lead-based die adhesive used between the die and leadframe. The component is otherwise considered Pb-Free (RoHS compatible) as defined above.

Green (RoHS & no Sb/Br): TI defines "Green" to mean Pb-Free (RoHS compatible), and free of Bromine (Br) and Antimony (Sb) based flame retardants (Br or Sb do not exceed 0.1% by weight in homogeneous material)

(3) MSL, Peak Temp. -- The Moisture Sensitivity Level rating according to the JEDEC industry standard classifications, and peak solder temperature.

(4) Multiple Top-Side Markings will be inside parentheses. Only one Top-Side Marking contained in parentheses and separated by a "~" will appear on a device. If a line is indented then it is a continuation of the previous line and the two combined represent the entire Top-Side Marking for that device.

Important Information and Disclaimer: The information provided on this page represents TI's knowledge and belief as of the date that it is provided. TI bases its knowledge and belief on information provided by third parties, and makes no representation or warranty as to the accuracy of such information. Efforts are underway to better integrate information from third parties. TI has taken and continues to take reasonable steps to provide representative and accurate information but may not have conducted destructive testing or chemical analysis on incoming materials and chemicals. TI and TI suppliers consider certain information to be proprietary, and thus CAS numbers and other limited information may not be available for release.

In no event shall TI's liability arising out of such information exceed the total purchase price of the TI part(s) at issue in this document sold by TI to Customer on an annual basis.

TAPE AND REEL INFORMATION

QUADRANT ASSIGNMENTS FOR PIN 1 ORIENTATION IN TAPE

*All dimensions are nominal

Device	Package Type	Package Drawing	Pins	SPQ	Reel Diameter (mm)	Reel Width W1 (mm)	A0 (mm)	B0 (mm)	K0 (mm)	P1 (mm)	W (mm)	Pin1 Quadrant
BQ24072TRGTR	QFN	RGT	16	3000	330.0	12.4	3.3	3.3	1.1	8.0	12.0	Q2
BQ24072TRGTT	QFN	RGT	16	250	180.0	12.4	3.3	3.3	1.1	8.0	12.0	Q2
BQ24075TRGTR	QFN	RGT	16	3000	330.0	12.4	3.3	3.3	1.1	8.0	12.0	Q2
BQ24075TRGTT	QFN	RGT	16	250	180.0	12.4	3.3	3.3	1.1	8.0	12.0	Q2
BQ24079TRGTR	QFN	RGT	16	3000	330.0	12.4	3.3	3.3	1.1	8.0	12.0	Q2
BQ24079TRGTT	QFN	RGT	16	250	180.0	12.4	3.3	3.3	1.1	8.0	12.0	Q2

TAPE AND REEL BOX DIMENSIONS

*All dimensions are nominal

Device	Package Type	Package Drawing	Pins	SPQ	Length (mm)	Width (mm)	Height (mm)
BQ24072TRGTR	QFN	RGT	16	3000	367.0	367.0	35.0
BQ24072TRGTT	QFN	RGT	16	250	210.0	185.0	35.0
BQ24075TRGTR	QFN	RGT	16	3000	367.0	367.0	35.0
BQ24075TRGTT	QFN	RGT	16	250	210.0	185.0	35.0
BQ24079TRGTR	QFN	RGT	16	3000	367.0	367.0	35.0
BQ24079TRGTT	QFN	RGT	16	250	210.0	185.0	35.0

RGT (S-PVQFN-N16)

PLASTIC QUAD FLATPACK NO-LEAD

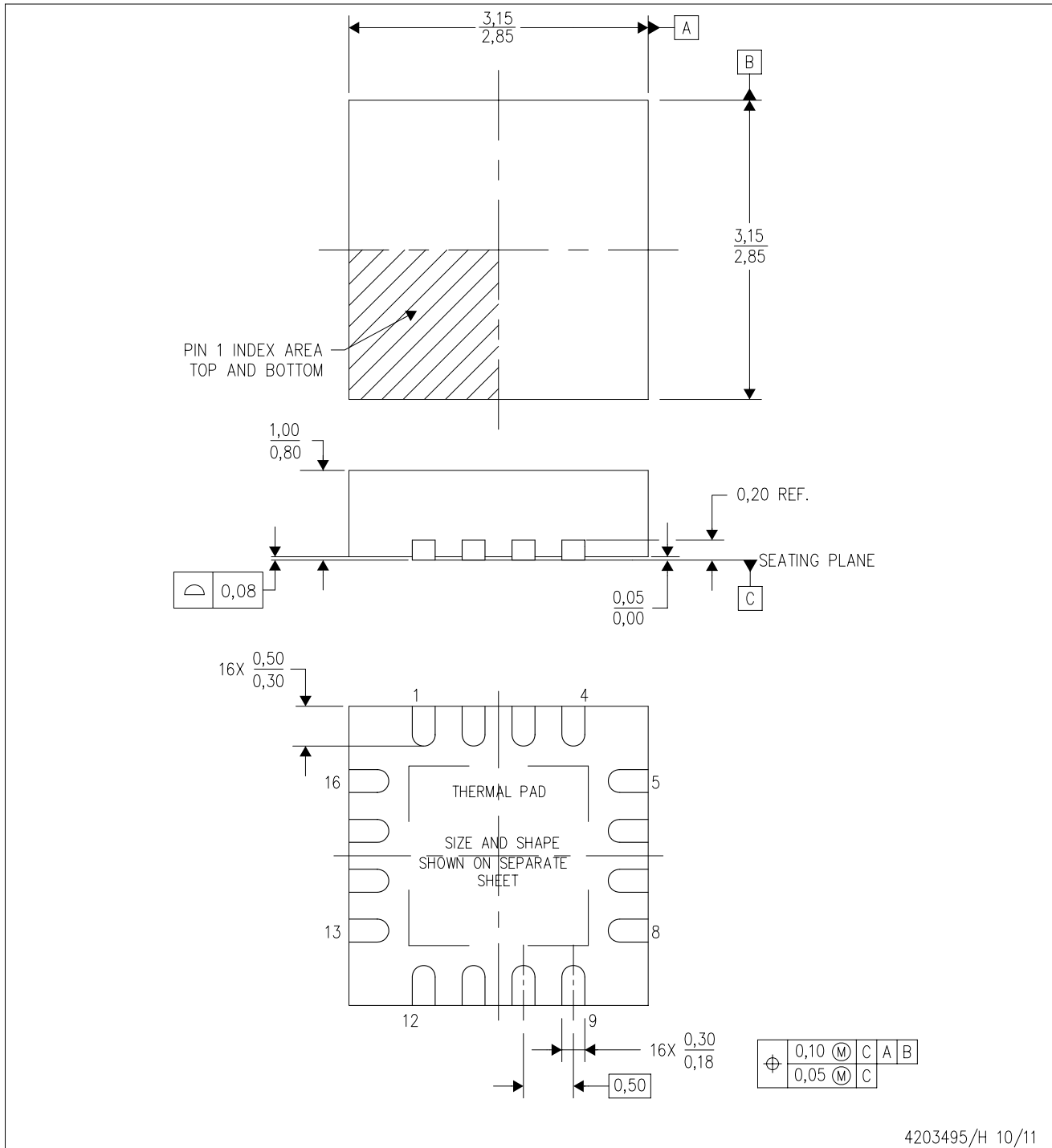

4203495/H 10/11

- NOTES:
- All linear dimensions are in millimeters. Dimensioning and tolerancing per ASME Y14.5M-1994.
 - This drawing is subject to change without notice.
 - Quad Flatpack, No-leads (QFN) package configuration.
 - The package thermal pad must be soldered to the board for thermal and mechanical performance.
 - See the additional figure in the Product Data Sheet for details regarding the exposed thermal pad features and dimensions.
 - Falls within JEDEC MO-220.

THERMAL PAD MECHANICAL DATA

RGT (S-PVQFN-N16)

PLASTIC QUAD FLATPACK NO-LEAD

THERMAL INFORMATION

This package incorporates an exposed thermal pad that is designed to be attached directly to an external heatsink. The thermal pad must be soldered directly to the printed circuit board (PCB). After soldering, the PCB can be used as a heatsink. In addition, through the use of thermal vias, the thermal pad can be attached directly to the appropriate copper plane shown in the electrical schematic for the device, or alternatively, can be attached to a special heatsink structure designed into the PCB. This design optimizes the heat transfer from the integrated circuit (IC).

For information on the Quad Flatpack No-Lead (QFN) package and its advantages, refer to Application Report, QFN/SON PCB Attachment, Texas Instruments Literature No. SLUA271. This document is available at www.ti.com.

The exposed thermal pad dimensions for this package are shown in the following illustration.

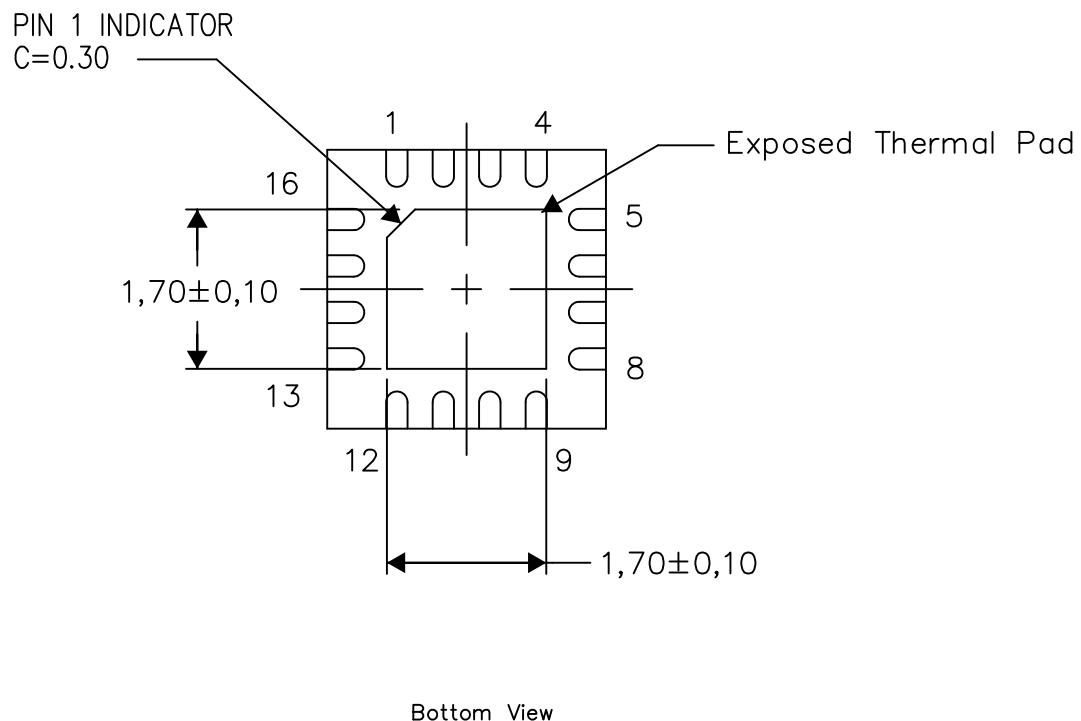

Exposed Thermal Pad Dimensions

4206349-4/T 05/13

NOTE: All linear dimensions are in millimeters

RGT (S-PVQFN-N16)

PLASTIC QUAD FLATPACK NO-LEAD

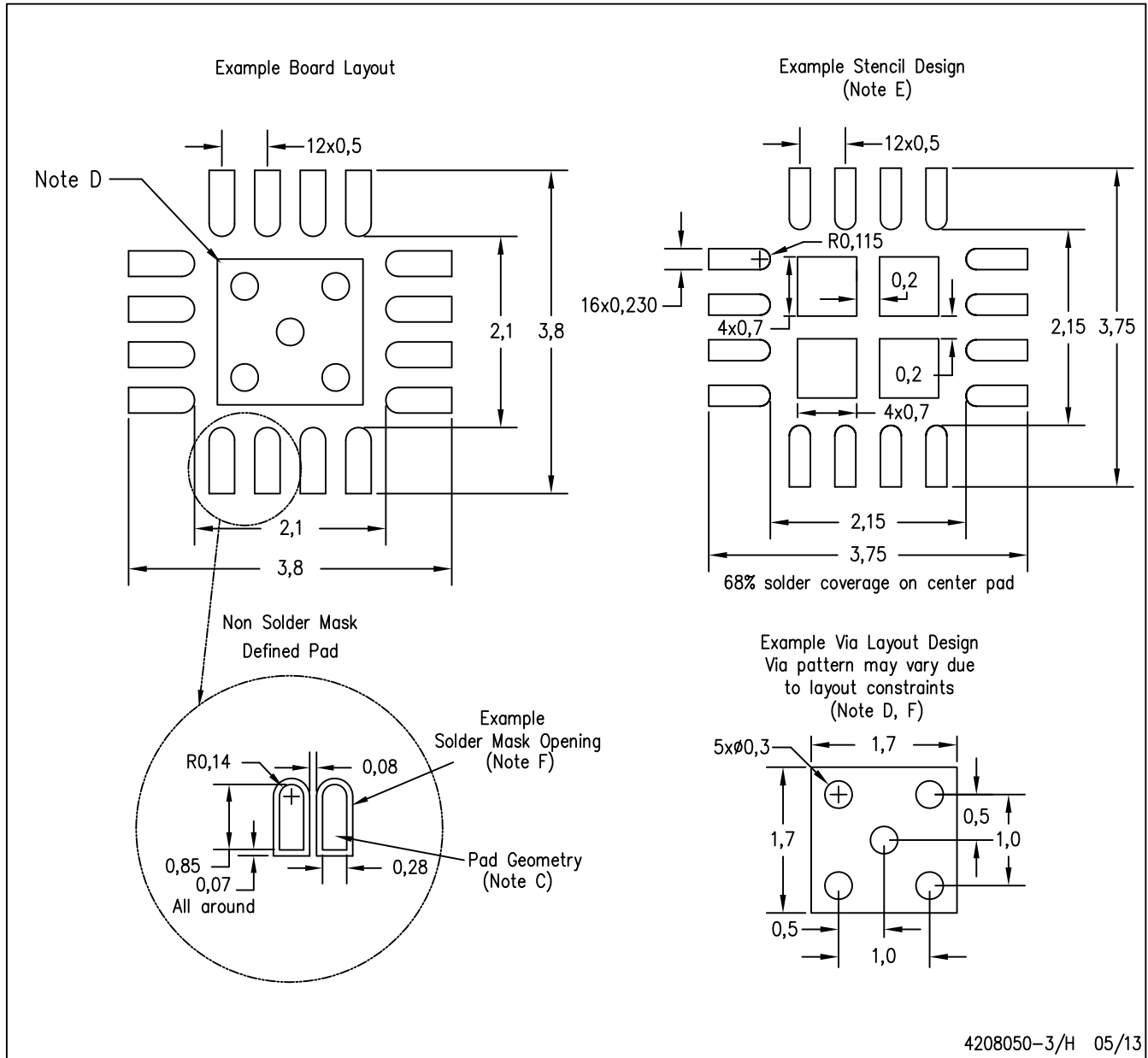

- NOTES:
- A. All linear dimensions are in millimeters.
 - B. This drawing is subject to change without notice.
 - C. Publication IPC-7351 is recommended for alternate designs.
 - D. This package is designed to be soldered to a thermal pad on the board. Refer to Application Note, QFN/SON PCB Attachment, Texas Instruments Literature No. SLUA271, and also the Product Data Sheets for specific thermal information, via requirements, and recommended board layout. These documents are available at www.ti.com <<http://www.ti.com>>.
 - E. Laser cutting apertures with trapezoidal walls and also rounding corners will offer better paste release. Customers should contact their board assembly site for stencil design recommendations. Refer to IPC 7525 for stencil design considerations.
 - F. Customers should contact their board fabrication site for minimum solder mask web tolerances between signal pads.

THERMAL PAD MECHANICAL DATA

RGT (S-PVQFN-N16)

PLASTIC QUAD FLATPACK NO-LEAD

THERMAL INFORMATION

This package incorporates an exposed thermal pad that is designed to be attached directly to an external heatsink. The thermal pad must be soldered directly to the printed circuit board (PCB). After soldering, the PCB can be used as a heatsink. In addition, through the use of thermal vias, the thermal pad can be attached directly to the appropriate copper plane shown in the electrical schematic for the device, or alternatively, can be attached to a special heatsink structure designed into the PCB. This design optimizes the heat transfer from the integrated circuit (IC).

For information on the Quad Flatpack No-Lead (QFN) package and its advantages, refer to Application Report, QFN/SON PCB Attachment, Texas Instruments Literature No. SLUA271. This document is available at www.ti.com.

The exposed thermal pad dimensions for this package are shown in the following illustration.

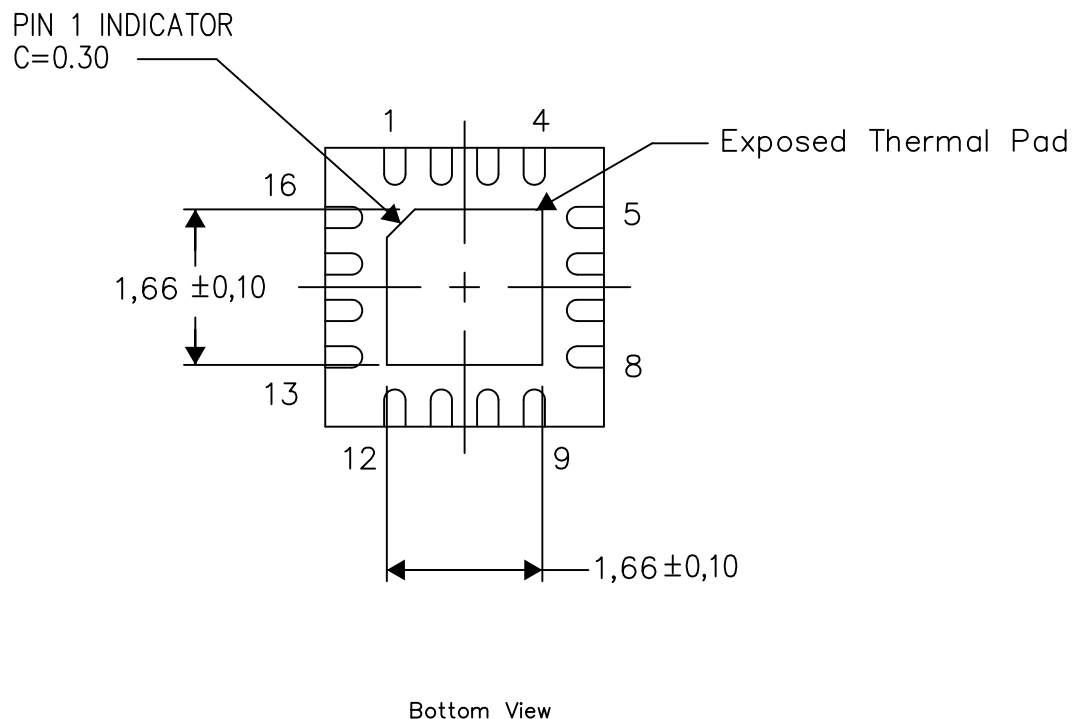

Exposed Thermal Pad Dimensions

4206349-9/T 05/13

NOTE: All linear dimensions are in millimeters

IMPORTANT NOTICE

Texas Instruments Incorporated and its subsidiaries (TI) reserve the right to make corrections, enhancements, improvements and other changes to its semiconductor products and services per JESD46, latest issue, and to discontinue any product or service per JESD48, latest issue. Buyers should obtain the latest relevant information before placing orders and should verify that such information is current and complete. All semiconductor products (also referred to herein as "components") are sold subject to TI's terms and conditions of sale supplied at the time of order acknowledgment.

TI warrants performance of its components to the specifications applicable at the time of sale, in accordance with the warranty in TI's terms and conditions of sale of semiconductor products. Testing and other quality control techniques are used to the extent TI deems necessary to support this warranty. Except where mandated by applicable law, testing of all parameters of each component is not necessarily performed.

TI assumes no liability for applications assistance or the design of Buyers' products. Buyers are responsible for their products and applications using TI components. To minimize the risks associated with Buyers' products and applications, Buyers should provide adequate design and operating safeguards.

TI does not warrant or represent that any license, either express or implied, is granted under any patent right, copyright, mask work right, or other intellectual property right relating to any combination, machine, or process in which TI components or services are used. Information published by TI regarding third-party products or services does not constitute a license to use such products or services or a warranty or endorsement thereof. Use of such information may require a license from a third party under the patents or other intellectual property of the third party, or a license from TI under the patents or other intellectual property of TI.

Reproduction of significant portions of TI information in TI data books or data sheets is permissible only if reproduction is without alteration and is accompanied by all associated warranties, conditions, limitations, and notices. TI is not responsible or liable for such altered documentation. Information of third parties may be subject to additional restrictions.

Resale of TI components or services with statements different from or beyond the parameters stated by TI for that component or service voids all express and any implied warranties for the associated TI component or service and is an unfair and deceptive business practice. TI is not responsible or liable for any such statements.

Buyer acknowledges and agrees that it is solely responsible for compliance with all legal, regulatory and safety-related requirements concerning its products, and any use of TI components in its applications, notwithstanding any applications-related information or support that may be provided by TI. Buyer represents and agrees that it has all the necessary expertise to create and implement safeguards which anticipate dangerous consequences of failures, monitor failures and their consequences, lessen the likelihood of failures that might cause harm and take appropriate remedial actions. Buyer will fully indemnify TI and its representatives against any damages arising out of the use of any TI components in safety-critical applications.

In some cases, TI components may be promoted specifically to facilitate safety-related applications. With such components, TI's goal is to help enable customers to design and create their own end-product solutions that meet applicable functional safety standards and requirements. Nonetheless, such components are subject to these terms.

No TI components are authorized for use in FDA Class III (or similar life-critical medical equipment) unless authorized officers of the parties have executed a special agreement specifically governing such use.

Only those TI components which TI has specifically designated as military grade or "enhanced plastic" are designed and intended for use in military/aerospace applications or environments. Buyer acknowledges and agrees that any military or aerospace use of TI components which have *not* been so designated is solely at the Buyer's risk, and that Buyer is solely responsible for compliance with all legal and regulatory requirements in connection with such use.

TI has specifically designated certain components as meeting ISO/TS16949 requirements, mainly for automotive use. In any case of use of non-designated products, TI will not be responsible for any failure to meet ISO/TS16949.

Products

Audio	www.ti.com/audio
Amplifiers	amplifier.ti.com
Data Converters	dataconverter.ti.com
DLP® Products	www.dlp.com
DSP	dsp.ti.com
Clocks and Timers	www.ti.com/clocks
Interface	interface.ti.com
Logic	logic.ti.com
Power Mgmt	power.ti.com
Microcontrollers	microcontroller.ti.com
RFID	www.ti-rfid.com
OMAP Applications Processors	www.ti.com/omap
Wireless Connectivity	www.ti.com/wirelessconnectivity

Applications

Automotive and Transportation	www.ti.com/automotive
Communications and Telecom	www.ti.com/communications
Computers and Peripherals	www.ti.com/computers
Consumer Electronics	www.ti.com/consumer-apps
Energy and Lighting	www.ti.com/energy
Industrial	www.ti.com/industrial
Medical	www.ti.com/medical
Security	www.ti.com/security
Space, Avionics and Defense	www.ti.com/space-avionics-defense
Video and Imaging	www.ti.com/video

TI E2E Community

e2e.ti.com