



Complete DDR, DDR2 and DDR3 Memory Power Solution Synchronous Buck Controller, 3-A LDO, Buffered Reference for Embedded Computing Systems

 Check for Samples: [TPS59116](#)

FEATURES

- **Synchronous Buck Controller (VDDQ)**
 - **Wide-Input Voltage Range: 3.0-V to 28-V**
 - **D-CAP™ Mode with 100-ns Load Step Response**
 - **Current Mode Option Supports Ceramic Output Capacitors**
 - **Supports Soft-Off in S4/S5 States**
 - **Current Sensing from $R_{DS(on)}$ or Resistor**
 - **2.5-V (DDR), 1.8-V (DDR2), Adjustable to 1.5-V (DDR3) or Output Range 0.75-V to 3.0-V**
 - **Equipped with Power Good, Overvoltage Protection and Undervoltage Protection**
- **3-A LDO (VTT), Buffered Reference (VREF)**
 - **Capable to Sink and Source 3 A**
 - **LDO Input Available to Optimize Power Losses**
 - **Requires Small 20- μ F Ceramic Output Capacitor**
 - **Buffered Low Noise 10-mA VREF Output**
 - **Accuracy ± 20 mV for both VREF and VTT**
 - **Supports High-Z in S3 and Soft-Off in S4/S5**
 - **Thermal Shutdown**

DESCRIPTION

The TPS59116 provides a complete power supply for DDR/SSTL-2, DDR2/SSTL-18, and DDR3 memory systems. It integrates a synchronous buck controller with a 3-A sink/source tracking linear regulator and buffered low noise reference. The TPS59116 offers the lowest total solution cost in systems where space is at a premium. The TPS59116 synchronous controller runs fixed 400-kHz pseudo-constant frequency PWM with an adaptive on-time control that can be configured in D-CAP™ Mode for ease of use and fastest transient response or in current mode to support ceramic output capacitors. The 3-A sink/source LDO maintains fast transient response only requiring 20- μ F ($2 \times 10 \mu\text{F}$) of ceramic output capacitance. In addition, the LDO supply input is available externally to significantly reduce the total power losses. The TPS59116 supports all of the sleep state controls placing VTT at high-Z in S3 (suspend to RAM) and discharging VDDQ, VTT and VTTREF (soft-off) in S4/S5 (suspend to disk). TPS59116 has all of the protection features including thermal shutdown and is offered in a 24-pin 4 mm \times 4mm QFN package.

APPLICATIONS

- **DDR/DDR2/DDR3/LPDDR3 Memory Power Supplies in Embedded Computing System**
- **SSTL-2 SSTL-18 and HSTL Termination**

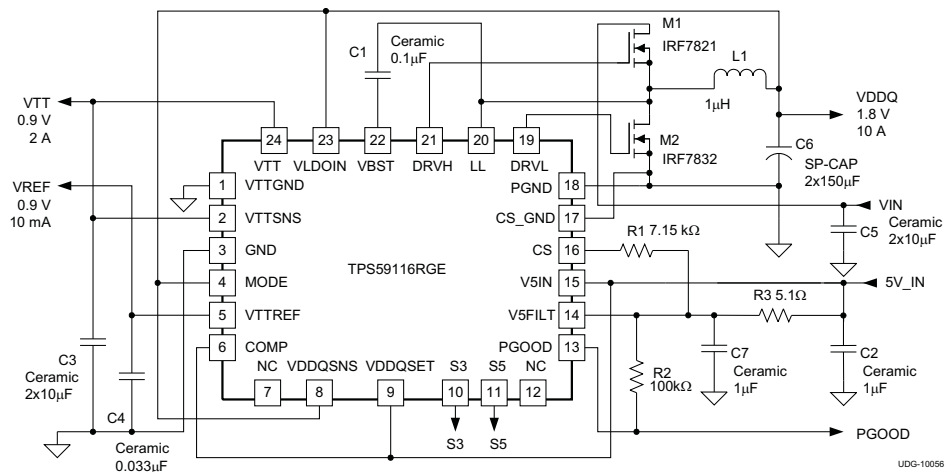

Please be aware that an important notice concerning availability, standard warranty, and use in critical applications of Texas Instruments semiconductor products and disclaimers thereto appears at the end of this data sheet.

D-CAP is a trademark of Texas Instruments.



This integrated circuit can be damaged by ESD. Texas Instruments recommends that all integrated circuits be handled with appropriate precautions. Failure to observe proper handling and installation procedures can cause damage.

ESD damage can range from subtle performance degradation to complete device failure. Precision integrated circuits may be more susceptible to damage because very small parametric changes could cause the device not to meet its published specifications.

ORDERING INFORMATION⁽¹⁾

T _A	PACKAGE	ORDERABLE PART NUMBER	PINS	OUTPUT SUPPLY	MINIMUM ORDER QUANTITY
-40°C to 85°C	Plastic Quad Flat Pack (QFN)	TPS59116RGER	24	Large tape-and-reel	3000
		TPS59116RGET		Small tape-and-reel	250

(1) All packaging options have Cu NIPDAU lead/ball finish.

ABSOLUTE MAXIMUM RATINGS⁽¹⁾

over operating free-air temperature range unless otherwise noted

		TPS59116	UNITS
V _{IN} Input voltage range	VBST	-0.3 to 36	V
	VBST wrt LL	-0.3 to 6	
	CS, MODE, S3, S5, VTTSNS, VDDQSNS, V5IN, VLDOIN, VDDQSET, V5FILT	-0.3 to 6	
	PGND, VTTGND, CS_GND	-0.3 to 0.3	
V _{OUT} Output voltage range	DRVH	-1.0 to 36	V
	LL	-1.0 to 30	
	COMP, DRVL, PGOOD, VTT, VTTREF	-0.3 to 6	
T _A Operating ambient temperature range		-40 to 85	°C
T _{stg} Storage temperature		-55 to 150	

(1) Stresses beyond those listed under "absolute maximum ratings" may cause permanent damage to the device. These are stress ratings only, and functional operation of the device at these or any other conditions beyond those indicated under "recommended operating conditions" is not implied. Exposure to absolute-maximum-rated conditions for extended periods may affect device reliability. All voltage values are with respect to the network ground terminal unless otherwise noted.

RECOMMENDED OPERATING CONDITIONS

		MIN	MAX	UNIT
Supply voltage	V5IN, V5FILT	4.75	5.25	V
Voltage range	VBST, DRVH	-0.1	34	V
	LL	-0.6	28	
	VLDOIN, VTT, VTTSNS, VDDQSNS	-0.1	3.6	
	VTTREF	-0.1	1.8	
	PGND, VTTGND, CS_GND	-0.1	0.1	
	S3, S5, MODE, VDDQSET, CS, COMP, PGOOD, DRVL	-0.1	5.25	
Operating free-air temperature, T _A		-40	85	°C

DISSIPATION RATINGS

PACKAGE	T _A < 25°C POWER RATING (W)	DERATING FACTOR ABOVE T _A = 25°C (mW/°C)	T _A = 85°C POWER RATING (W)
24-pin RGE	2.20	22.0	0.88

ELECTRICAL CHARACTERISTICS

 over operating free-air temperature range, $V_{V5IN} = V_{V5FILT} = 5\text{ V}$, VLDOIN is connected to VDDQ output (unless otherwise noted)

PARAMETER		TEST CONDITIONS	MIN	TYP	MAX	UNIT
SUPPLY CURRENT						
I_{V5IN1}	Supply current 1, V5FILT	$T_A = 25^\circ\text{C}$, No load, $V_{S3} = V_{S5} = 5\text{ V}$, COMP connected to capacitor		0.8	2	mA
I_{V5IN2}	Supply current 2, V5FILT	$T_A = 25^\circ\text{C}$, No load, $V_{S3} = 0\text{ V}$, $V_{S5} = 5\text{ V}$, COMP connected to capacitor		300	600	μA
I_{V5IN3}	Supply current 3, V5FILT	$T_A = 25^\circ\text{C}$, No load, $V_{S3} = 0\text{ V}$, $V_{S5} = 5\text{ V}$, $V_{COMP} = 5\text{ V}$		240	500	
$I_{V5INSDN}$	Shutdown current, V5FILT	$T_A = 25^\circ\text{C}$, No load, $V_{S3} = V_{S5} = 0\text{ V}$		0.1	1.0	μA
$I_{VLDOIN1}$	Supply current 1, VLDOIN	$T_A = 25^\circ\text{C}$, No load, $V_{S3} = V_{S5} = 5\text{ V}$		1	10	
$I_{VLDOIN2}$	Supply current 2, VLDOIN	$T_A = 25^\circ\text{C}$, No load, $V_{S3} = 5\text{ V}$, $V_{S5} = 0\text{ V}$,		0.1	10	
$I_{VLDOINSDN}$	Standby current, VLDOIN	$T_A = 25^\circ\text{C}$, No load, $V_{S3} = V_{S5} = 0\text{ V}$		0.1	1.0	
VTTREF OUTPUT						
V_{VTTREF}	Output voltage, VTTREF		$V_{VDDQSNS}/2$			V
$V_{VTTREFTOL}$	Output voltage tolerance	$-10\text{ mA} < I_{VTTREF} < 10\text{ mA}$, $V_{VDDQSNS} = 2.5\text{ V}$, Tolerance to $V_{VDDQSNS}/2$	-20		20	mV
		$-10\text{ mA} < I_{VTTREF} < 10\text{ mA}$, $V_{VDDQSNS} = 1.8\text{ V}$, Tolerance to $V_{VDDQSNS}/2$	-18		18	
		$-10\text{ mA} < I_{VTTREF} < 10\text{ mA}$, $V_{VDDQSNS} = 1.5\text{ V}$, Tolerance to $V_{VDDQSNS}/2$	-15		15	
		$-10\text{ mA} < I_{VTTREF} < 10\text{ mA}$, $V_{VDDQSNS} = 1.2\text{ V}$, Tolerance to $V_{VDDQSNS}/2$	-12		12	
$V_{VTTREFSRC}$	Source current	$V_{VDDQSNS} = 2.5\text{ V}$, $V_{VTTREF} = 0\text{ V}$	-20	-40	-80	mA
$V_{VTTREFSNK}$	Sink current	$V_{VDDQSNS} = 2.5\text{ V}$, $V_{VTTREF} = 2.5\text{ V}$	20	40	80	
VTT OUTPUT						
$V_{VTTSENS}$	Output voltage, VTT	$V_{S3} = V_{S5} = 5\text{ V}$, $V_{VLDOIN} = V_{VDDQSNS} = 2.5\text{ V}$		1.25		V
		$V_{S3} = V_{S5} = 5\text{ V}$, $V_{VLDOIN} = V_{VDDQSNS} = 1.8\text{ V}$		0.9		
		$V_{S3} = V_{S5} = 5\text{ V}$, $V_{VLDOIN} = V_{VDDQSNS} = 1.5\text{ V}$		0.75		
$V_{VTTTOL25}$	VTT output voltage tolerance to VTTREF	$V_{VDDQSNS} = V_{VLDOIN} = 2.5\text{ V}$, $V_{S3} = V_{S5} = 5\text{ V}$, $I_{VTT} = 0\text{ A}$	-20		20	mV
		$V_{VDDQSNS} = V_{VLDOIN} = 2.5\text{ V}$, $V_{S3} = V_{S5} = 5\text{ V}$, $ I_{VTT} < 1.5\text{ A}$	-30		30	
		$V_{VDDQSNS} = V_{VLDOIN} = 2.5\text{ V}$, $V_{S3} = V_{S5} = 5\text{ V}$, $ I_{VTT} < 3\text{ A}$	-40		40	
$V_{VTTTOL18}$	VTT output voltage tolerance to VTTREF	$V_{VDDQSNS} = V_{VLDOIN} = 1.8\text{ V}$, $V_{S3} = V_{S5} = 5\text{ V}$, $I_{VTT} = 0\text{ A}$	-20		20	
		$V_{VDDQSNS} = V_{VLDOIN} = 1.8\text{ V}$, $V_{S3} = V_{S5} = 5\text{ V}$, $ I_{VTT} < 1\text{ A}$	-30		30	
		$V_{VDDQSNS} = V_{VLDOIN} = 1.8\text{ V}$, $V_{S3} = V_{S5} = 5\text{ V}$, $ I_{VTT} < 2\text{ A}$	-40		40	
$V_{VTTTOL15}$	VTT output voltage tolerance to VTTREF	$V_{VDDQSNS} = V_{VLDOIN} = 1.5\text{ V}$, $V_{S3} = V_{S5} = 5\text{ V}$, $I_{VTT} = 0\text{ A}$	-20		20	
		$V_{VDDQSNS} = V_{VLDOIN} = 1.5\text{ V}$, $V_{S3} = V_{S5} = 5\text{ V}$, $ I_{VTT} < 1\text{ A}$	-30		30	
		$V_{VDDQSNS} = V_{VLDOIN} = 1.5\text{ V}$, $V_{S3} = V_{S5} = 5\text{ V}$, $ I_{VTT} < 2\text{ A}$	-40		40	
$V_{VTTTOL12}$	VTT output voltage tolerance to VTTREF	$V_{VDDQSNS} = V_{VLDOIN} = 1.2\text{ V}$, $V_{S3} = V_{S5} = 5\text{ V}$, $I_{VTT} = 0\text{ A}$	-20		20	
		$V_{VDDQSNS} = V_{VLDOIN} = 1.2\text{ V}$, $V_{S3} = V_{S5} = 5\text{ V}$, $ I_{VTT} < 1\text{ A}$	-30		30	
		$V_{VDDQSNS} = V_{VLDOIN} = 1.2\text{ V}$, $V_{S3} = V_{S5} = 5\text{ V}$, $ I_{VTT} < 1.5\text{ A}$	-40		40	

ELECTRICAL CHARACTERISTICS (continued)

over operating free-air temperature range, $V_{V5IN} = V_{V5FILT} = 5\text{ V}$, VLDOIN is connected to VDDQ output (unless otherwise noted)

PARAMETER		TEST CONDITIONS	MIN	TYP	MAX	UNIT
VTT OUTPUT (continued)						
$I_{VTTCLSRC}$	Source current limit, VTT	$V_{VLDOIN} = V_{VDDQSNS} = 2.5\text{ V}$, $V_{VTT} = V_{VTTSENS} = 1.19\text{ V}$, PGOOD = HI	3.0	3.8	6.0	A
		$V_{VLDOIN} = V_{VDDQSNS} = 2.5\text{ V}$, $V_{VTT} = 0\text{ V}$	1.5	2.2	3.0	
$I_{VTTCLSNK}$	Sink current limit, VTT	$V_{VLDOIN} = V_{VDDQSNS} = 2.5\text{ V}$, $V_{VTT} = V_{VTTSENS} = 1.31\text{ V}$, PGOOD = HI	3.0	3.6	6.0	
		$V_{VLDOIN} = V_{VDDQSNS} = 2.5\text{ V}$, $V_{VTT} = V_{VDDQ}$	1.5	2.2	3.0	
I_{VTTLK}	Leakage current, VTT	$V_{S3} = 0\text{ V}$, $V_{S5} = 5\text{ V}$, $V_{VTT} = V_{VDDQSNS} / 2$	-10		10	μA
$I_{VTTBIAS}$	Input bias current, VTTSENS	$V_{S3} = 5\text{ V}$, $V_{VTTSENS} = V_{VDDQSNS} / 2$	-1	-0.1	1	
$I_{VTTNSLK}$	Leakage current, VTTSENS	$V_{S3} = 0\text{ V}$, $V_{S5} = 5\text{ V}$, $V_{VTT} = V_{VDDQSNS} / 2$	-1		1	
$I_{VTTDisch}$	Discharge current, VTT	$T_A = 25^\circ\text{C}$, $V_{S3} = V_{S5} = V_{VDDQSNS} = 0\text{ V}$, $V_{VTT} = 0.5\text{ V}$	10	17		mA
VDDQ OUTPUT						
V_{VDDQ}	Output voltage, VDDQ	$T_A = 25^\circ\text{C}$, $V_{VDDQSET} = 0\text{ V}$, No load	2.465	2.500	2.535	V
		$0^\circ\text{C} \leq T_A \leq 85^\circ\text{C}$, $V_{VDDQSET} = 0\text{ V}$, No load ⁽¹⁾	2.457	2.500	2.543	
		$-40^\circ\text{C} \leq T_A \leq 85^\circ\text{C}$, $V_{VDDQSET} = 0\text{ V}$, No load ⁽¹⁾	2.440	2.500	2.550	
		$T_A = 25^\circ\text{C}$, $V_{VDDQSET} = 5\text{ V}$, No load ⁽¹⁾	1.776	1.800	1.824	
		$0^\circ\text{C} \leq T_A \leq 85^\circ\text{C}$, $V_{VDDQSET} = 5\text{ V}$, No load ⁽¹⁾	1.769	1.800	1.831	
		$-40^\circ\text{C} \leq T_A \leq 85^\circ\text{C}$, $V_{VDDQSET} = 5\text{ V}$, No load ⁽¹⁾	1.764	1.800	1.836	
		$-40^\circ\text{C} \leq T_A \leq 85^\circ\text{C}$, Adjustable mode, No load ⁽¹⁾	0.75		3.0	
$V_{VDDQSET}$	VDDQSET regulation voltage	$T_A = 25^\circ\text{C}$, Adjustable mode	742.5	750.0	757.5	mV
		$0^\circ\text{C} \leq T_A \leq 85^\circ\text{C}$, Adjustable mode	740.2	750.0	759.8	
		$-40^\circ\text{C} \leq T_A \leq 85^\circ\text{C}$, Adjustable mode	738.0	750.0	762.0	
$R_{VDDQSNS}$	Input impedance, VDDQSNS	$V_{VDDQSET} = 0\text{ V}$		215		k Ω
		$V_{VDDQSET} = 5\text{ V}$		180		
		Adjustable mode		460		
$I_{VDDQSET}$	Input current, VDDQSET	$V_{VDDQSET} = 0.78\text{ V}$, COMP = Open		-0.04		μA
		$V_{VDDQSET} = 0.78\text{ V}$, COMP = 5 V		-0.06		
$I_{VDDQDisch}$	Discharge current, VDDQ	$V_{S3} = V_{S5} = 0\text{ V}$, $V_{VDDQSNS} = 0.5\text{ V}$, $V_{MODE} = 0\text{ V}$	10	40		mA
$I_{VLDOINDisch}$	Discharge current, VLDOIN	$V_{S3} = V_{S5} = 0\text{ V}$, $V_{VDDQSNS} = 0.5\text{ V}$, $V_{MODE} = 0.5\text{ V}$		700		
TRANSCONDUCTANCE AMPLIFIER						
g_M	Gain	$T_A = 25^\circ\text{C}$	240	300	360	μS
$I_{COMPSNK}$	COMP maximum sink current	$V_{S3} = 0\text{ V}$, $V_{S5} = 5\text{ V}$, $V_{VDDQSET} = 0\text{ V}$, $V_{VDDQSNS} = 2.7\text{ V}$, $V_{COMP} = 1.28\text{ V}$		13		μA
$I_{COMPSRC}$	COMP maximum source current	$V_{S3} = 0\text{ V}$, $V_{S5} = 5\text{ V}$, $V_{VDDQSET} = 0\text{ V}$, $V_{VDDQSNS} = 2.3\text{ V}$, $V_{COMP} = 1.28\text{ V}$		-13		
V_{COMPHI}	COMP high clamp voltage	$V_{S3} = 0\text{ V}$, $V_{S5} = 5\text{ V}$, $V_{VDDQSET} = 0\text{ V}$, $V_{VDDQSNS} = 2.3\text{ V}$, $V_{CS} = 0\text{ V}$	1.31	1.34	1.37	V
V_{COMPLO}	COMP low clamp voltage	$V_{S3} = 0\text{ V}$, $V_{S5} = 5\text{ V}$, $V_{VDDQSET} = 0\text{ V}$, $V_{VDDQSNS} = 2.7\text{ V}$, $V_{CS} = 0\text{ V}$	1.18	1.21	1.24	
DUTY CONTROL						
t_{ON}	Operating on-time	$V_{IN} = 12\text{ V}$, $V_{VDDQSET} = 0\text{ V}$		520		ns
t_{ON0}	Startup on-time	$V_{IN} = 12\text{ V}$, $V_{VDDQSNS} = 0\text{ V}$		125		
$t_{ON(min)}$	Minimum on-time	$T_A = 25^\circ\text{C}$ ⁽¹⁾		100		
$t_{OFF(min)}$	Minimum off-time	$T_A = 25^\circ\text{C}$ ⁽¹⁾		350		

(1) Ensured by design. Not production tested.

ELECTRICAL CHARACTERISTICS (continued)

 over operating free-air temperature range, $V_{V5IN} = V_{V5FILT} = 5\text{ V}$, VLDOIN is connected to VDDQ output (unless otherwise noted)

PARAMETER		TEST CONDITIONS	MIN	TYP	MAX	UNIT
ZERO CURRENT COMPARATOR						
V_{ZC}	Zero current comparator offset		-6	0	6	mV
OUTPUT DRIVERS						
R_{DRVH}	DRVH resistance	Source, $I_{DRVH} = -100\text{ mA}$		3	6	Ω
		Sink, $I_{DRVH} = 100\text{ mA}$		0.9	3	
R_{DRVL}	DRVL resistance	Source, $I_{DRVL} = -100\text{ mA}$		3	6	
		Sink, $I_{DRVL} = 100\text{ mA}$		0.9	3	
t_D	Dead time	LL-low to DRVL-on ⁽¹⁾		10		ns
		DRVL-off to DRVH-on ⁽¹⁾		20		
INTERNAL BST DIODE						
V_{FBST}	Forward voltage	$V_{V5IN-VBST}$, $I_F = 10\text{ mA}$, $T_A = 25^\circ\text{C}$	0.7	0.8	0.9	V
I_{VBSTLK}	VBST leakage current	$V_{VBST} = 34\text{ V}$, $V_{LL} = 28\text{ V}$, $V_{VDDQ} = 2.6\text{ V}$, $T_A = 25^\circ\text{C}$		0.1	1.0	μA
PROTECTIONS						
V_{OCL}	Current limit threshold	$V_{PGND-CS}$, PGOOD = HI, $V_{CS} < 0.5\text{ V}$	50	60	70	mV
		$V_{PGND-CS}$, PGOOD = LO, $V_{CS} < 0.5\text{ V}$	20	30	40	
I_{TRIP}	Current sense sink current	$T_A = 25^\circ\text{C}$, $V_{CS} > 4.5\text{ V}$, PGOOD = HI	9	10	11	μA
		$T_A = 25^\circ\text{C}$, $V_{CS} > 4.5\text{ V}$, PGOOD = LO	4	5	6	
T_{CITRIP}	TRIP current temperature coefficient	$R_{DS(on)}$ sense scheme, On the basis of $T_A = 25^\circ\text{C}$ ⁽²⁾		4500		ppm/ $^\circ\text{C}$
$V_{OCL(off)}$	Overcurrent protection COMP offset	$(V_{V5IN-CS} - V_{PGND-LL})$, $V_{V5IN-CS} = 60\text{ mV}$, $V_{CS} > 4.5\text{ V}$ ⁽²⁾	-5	0	5	mV
$V_{R(trip)}$	Current limit threshold setting range	$V_{V5IN-CS}$ ⁽²⁾	30		150	
POWERGOOD COMPARATOR						
$V_{TVDDQPG}$	VDDQ powergood threshold	PG in from lower	92.5%	95.0%	97.5%	
		PG in from higher	102.5%	105.0%	107.5%	
		PG hysteresis		5%		
$I_{PG(max)}$	PGOOD sink current	$V_{VTT} = 0\text{ V}$, $V_{PGOOD} = 0.5\text{ V}$	2.5	7.5		mA
$t_{PG(del)}$	PGOOD delay time	Delay for PG in	80	130	200	μs
UNDERVOLTAGE LOCKOUT/LOGIC THRESHOLD						
V_{UVV5IN}	V5IN UVLO threshold voltage	Wake up	3.7	4.0	4.3	V
		Hysteresis	0.2	0.3	0.4	
V_{THMODE}	MODE threshold	No discharge	4.7			
		Non-tracking discharge			0.1	
$V_{THVDDQSET}$	VDDQSET threshold voltage	2.5 V output	0.08	0.15	0.25	
		1.8 V output	3.5	4.0	4.5	
V_{IH}	High-level input voltage	S3, S5	2.2			
V_{IL}	Low-level input voltage	S3, S5			0.3	
V_{IHYST}	Hysteresis voltage	S3, S5		0.2		
V_{INLEAK}	Logic input leakage current	S3, S5, MODE	-1		1	
$V_{INVDDQSET}$	Input leakage/ bias current	VDDQSET	-1		1	

(2) Ensured by design. Not production tested.

ELECTRICAL CHARACTERISTICS (continued)

over operating free-air temperature range, $V_{V5IN} = V_{V5FILT} = 5\text{ V}$, VLDOIN is connected to VDDQ output (unless otherwise noted)

PARAMETER		TEST CONDITIONS	MIN	TYP	MAX	UNIT
UNDERVOLTAGE AND OVERVOLTAGE PROTECTION						
V_{OVP}	VDDQ OVP trip threshold voltage	OVP detect	110%	115%	120%	
		Hysteresis		5%		
T_{OVPDEL}	VDDQ OVP propagation delay ⁽³⁾			1.5		μs
V_{UVP}	Output UVP trip threshold	UVP detect		70%		
		Hysteresis		10%		
t_{UVPDEL}	Output UVP propagation delay ⁽³⁾			32		cycle
t_{UVPEN}	Output UVP enable delay ⁽³⁾			1007		
THERMAL SHUTDOWN						
T_{SDN}	Thermal SDN threshold ⁽³⁾	Shutdown temperature		160		°C
		Hysteresis		10		

(3) Ensured by design. Not production tested.

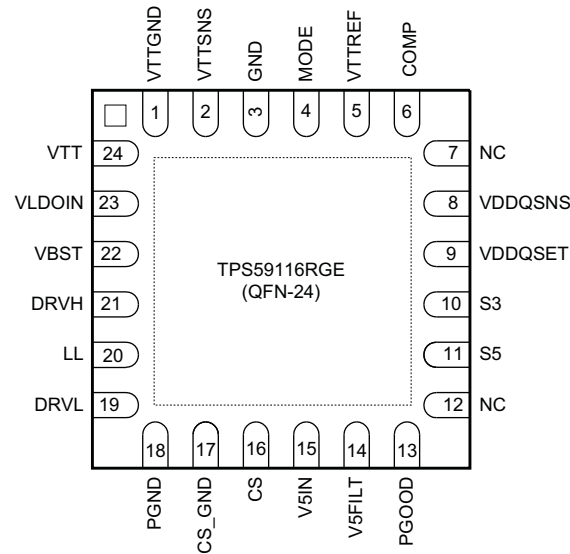
DEVICE INFORMATION

TERMINAL FUNCTIONS

TERMINAL		I/O	DESCRIPTION
NAME	NO.		
COMP	6	I/O	Output of the transconductance amplifier for phase compensation. Connect to V5IN to disable gm amplifier and use D-CAP™ mode.
CS	16	I/O	Current sense comparator input (-) for resistor current sense scheme. Or overcurrent trip voltage setting input for $R_{DS(on)}$ current sense scheme if connected to V5FILT through the voltage setting resistor.
DRVH	21	O	Switching (top) MOSFET gate drive output.
DRVL	19	O	Rectifying (bottom) MOSFET gate drive output.
GND	3	-	Signal ground. Connect to minus terminal of the VTT LDO output capacitor.
CS_GND	17		Current sense comparator input (+) and ground for powergood circuit.
LL	20	I/O	Switching (top) MOSFET gate driver return. Current sense comparator input (-) for $R_{DS(on)}$ current sense.
MODE	4	I	Discharge mode setting pin. See <i>VDDQ and VTT Discharge Control</i> section.
NC	7,12		No connect.
PGND	18	-	Ground for rectifying (bottom) MOSFET gate driver.
PGOOD	13	O	Powergood signal open drain output, In HIGH state when VDDQ output voltage is within the target range.
S3	10	I	S3 signal input.
S5	11	I	S5 signal input.
V5IN	15	I	5-V power supply input for MOSFET gate drivers.
V5FILT	14	I	Filtered 5-V power supply input for internal circuits. Connect R-C network from V5IN to V5FILT.
VBST	22	I/O	Switching (top) MOSFET driver bootstrap voltage input.
VDDQSET	9	I	VDDQ output voltage setting pin. See <i>VDDQ Output Voltage Selection</i> section.
VDDQSNS	8	I/O	VDDQ reference input for VTT and VTTREF. Power supply for the VTTREF. Discharge current sinking terminal for VDDQ Non-tracking discharge. Output voltage feedback input for VDDQ output if VDDQSET pin is connected to V5IN or GND.
VLDIOIN	23	I	Power supply for the VTT LDO.
VTT	24	O	Power output for the VTT LDO.
VTTGND	1	-	Power ground output for the VTT LDO.
VTTREF	5	O	VTTREF buffered reference output.
VTTSENS	2	I	Voltage sense input for the VTT LDO. Connect to plus terminal of the VTT LDO output capacitor.

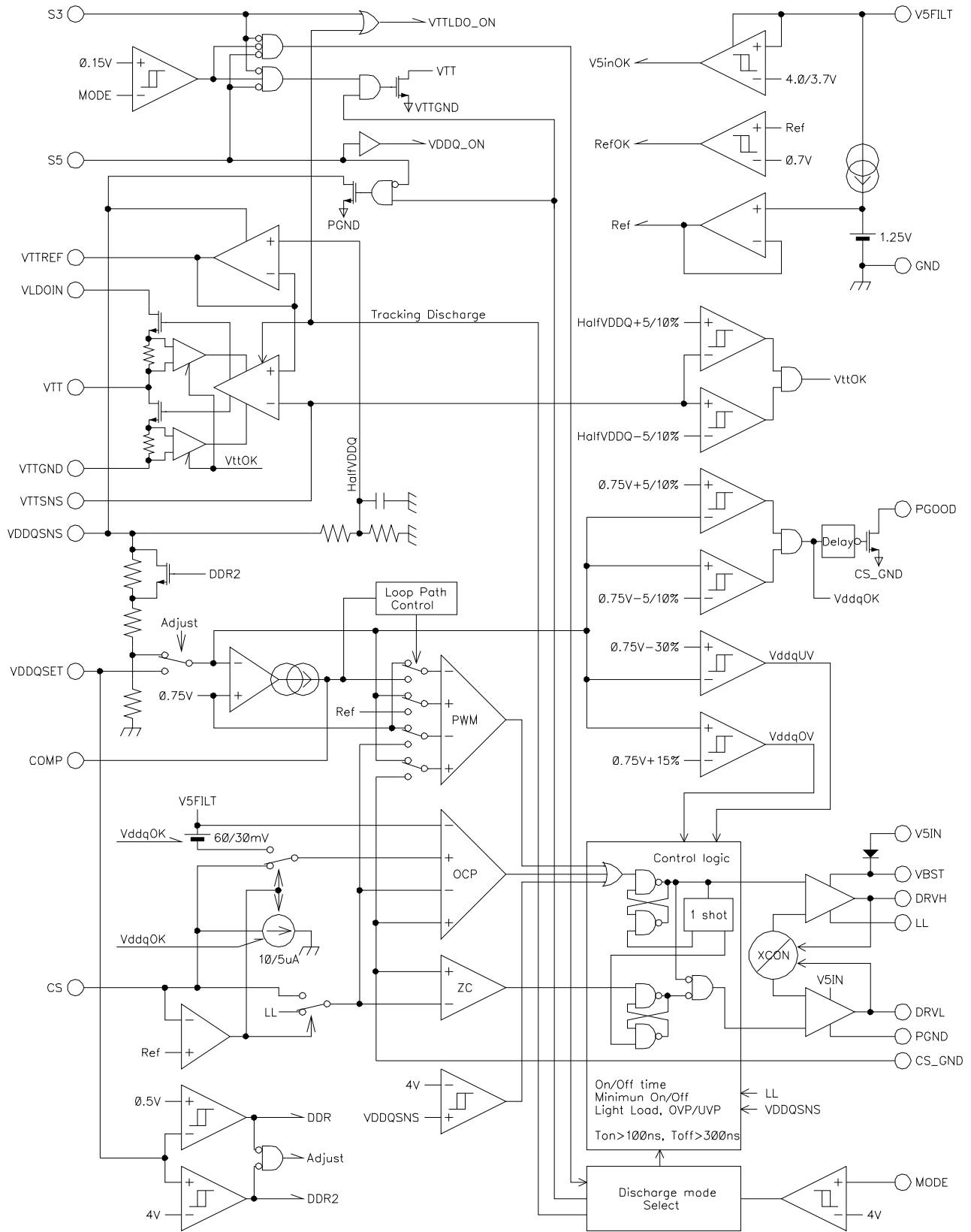
FUNCTIONAL BLOCK DIAGRAM (RGE)



DETAILED DESCRIPTION

The TPS59116 is an integrated power management solution which combines a synchronous buck controller, a 10-mA buffered reference and a high-current sink/source low-dropout linear regulator (LDO) in a small 20-pin HTSSOP package or a 24-pin QFN package. Each of these rails generates VDDQ, VTTREF and VTT that required with DDR/DDR2/DDR3 memory systems. The switch mode power supply (SMPS) portion employs external N-channel MOSFETs to support high current for DDR/DDR2/DDR3 memory's VDD/VDDQ. The preset output voltage is selectable from 2.5 V or 1.8 V. User defined output voltage is also possible and can be adjustable from 0.75 V to 3 V. Input voltage range of the SMPS is 3 V to 28 V. The SMPS runs an adaptive on-time PWM operation at high-load condition and automatically reduces frequency to keep excellent efficiency down to several mA. Current sensing scheme uses either $R_{DS(on)}$ of the external rectifying MOSFET for a low-cost, loss-less solution, or an optional sense resistor placed in series to the rectifying MOSFET for more accurate current limit. The output of the switcher is sensed by VDDQSNS pin to generate one-half VDDQ for the 10-mA buffered reference (VTTREF) and the VTT active termination supply. The VTT LDO can source and sink up to 3-A peak current with only 20- μ F (two 10- μ F in parallel) ceramic output capacitors. VTTREF tracks VDDQ/2 within $\pm 1\%$ of VDDQ. VTT output tracks VTTREF within ± 20 mV at no load condition while ± 40 mV at full load. The LDO input can be separated from VDDQ and optionally connected to a lower voltage by using VLDOIN pin. This helps reducing power dissipation in sourcing phase. The TPS59116 is fully compatible to JEDEC DDR/DDR2 specifications at S3/S5 sleep state (see [Table 2](#)). The part has two options of output discharge function when both VTT and VDDQ are disabled. The tracking discharge mode discharges VDDQ and VTT outputs through the internal LDO transistors and then VTT output tracks half of VDDQ voltage during discharge. The non-tracking discharge mode discharges outputs using internal discharge MOSFETs which are connected to VDDQSNS and VTT. The current capability of these discharge FETs are limited and discharge occurs more slowly than the tracking discharge. These discharge functions can be disabled by selecting non-discharge mode.

VDDQ SMPS, Dual PWM Operation Modes

The main control loop of the SMPS is designed as an adaptive on-time pulse width modulation (PWM) controller. It supports two control schemes which are a current mode and a proprietary D-CAP™ mode. D-CAP™ mode uses internal compensation circuit and is suitable for low external component count configuration with an appropriate amount of ESR at the output capacitor(s). Current mode control has more flexibility, using external compensation network, and can be used to achieve stable operation with very low ESR capacitor(s) such as ceramic or specialty polymer capacitors.

These control modes are selected by the COMP terminal connection. If the COMP pin is connected to V5IN, TPS59116 works in the D-CAP™ mode, otherwise it works in the current mode. VDDQ output voltage is monitored at a feedback point voltage. If VDDQSET is connected to V5IN or GND, this feedback point is the output of the internal resistor divider inside VDDQSNS pin. If an external resistor divider is connected to VDDQSET pin, VDDQSET pin itself becomes the feedback point (see *VDDQ Output Voltage Selection* section).

At the beginning of each cycle, the synchronous top MOSFET is turned on, or becomes ON state. This MOSFET is turned off, or becomes OFF state, after internal one shot timer expires. This one shot is determined by V_{IN} and V_{OUT} to keep frequency fairly constant over input voltage range, hence it is called adaptive on-time control (see *PWM Frequency and Adaptive On-Time Control* section). The MOSFET is turned on again when feedback information indicates insufficient output voltage and inductor current information indicates below the overcurrent limit. Repeating operation in this manner, the controller regulates the output voltage. The synchronous bottom or the *rectifying* MOSFET is turned on each OFF state to keep the conduction loss minimum. The rectifying MOSFET is turned off when inductor current information detects zero level. This enables seamless transition to the reduced frequency operation at light load condition so that high efficiency is kept over broad range of load current.

In the current mode control scheme, the transconductance amplifier generates a target current level corresponding to the voltage difference between the feedback point and the internal 750 mV reference. During the OFF state, the PWM comparator monitors the inductor current signal as well as this target current level, and when the inductor current signal comes lower than the target current level, the comparator provides SET signal to initiate the next ON state. The voltage feedback gain is adjustable outside the controller device to support various types of output MOSFETs and capacitors. In the D-CAP™ mode, the transconductance amplifier is disabled and the PWM comparator compares the feedback point voltage and the internal 750 mV reference during the OFF state. When the feedback point comes lower than the reference voltage, the comparator provides SET signal to initiate the next ON state.

VDDQ SMPS, Light Load Condition

TPS59116 automatically reduces switching frequency at light load condition to maintain high efficiency. This reduction of frequency is achieved smoothly and without increase of V_{OUT} ripple or load regulation. Detail operation is described as follows. As the output current decreases from heavy load condition, the inductor current is also reduced and eventually comes to the point that its *valley* touches zero current, which is the boundary between continuous conduction and discontinuous conduction modes. The rectifying MOSFET is turned off when this zero inductor current is detected. As the load current further decreased, the converter runs in discontinuous conduction mode and it takes longer and longer to discharge the output capacitor to the level that requires next *ON* cycle. The *ON*-time is kept the same as that in the heavy load condition. In reverse, when the output current increase from light load to heavy load, switching frequency increases to the constant 400 kHz as the inductor current reaches to the continuous conduction. The transition load point to the light load operation $I_{OUT(LL)}$ (i.e. the threshold between continuous and discontinuous conduction mode) can be calculated in [Equation 1](#):

$$I_{OUT(LL)} = \frac{1}{2 \times L \times f} \times \frac{(V_{IN} - V_{OUT}) \times V_{OUT}}{V_{IN}}$$

where

- f is the PWM switching frequency (400 kHz) (1)

Switching frequency versus output current in the light load condition is a function of L , f , V_{IN} and V_{OUT} , but it decreases almost proportional to the output current from the $I_{OUT(LL)}$ given above. For example, it is 40 kHz at $I_{OUT(LL)}/10$ and 4 kHz at $I_{OUT(LL)}/100$.

Low-Side Driver

The low-side driver is designed to drive high-current, low- $R_{DS(on)}$, N-channel MOSFET(s). The drive capability is represented by its internal resistance, which are 3 Ω for $V5IN$ to DRV_L and 0.9 Ω for DRV_L to $PGND$. A dead-time to prevent shoot through is internally generated between top MOSFET off to bottom MOSFET on, and bottom MOSFET off to top MOSFET on. 5-V bias voltage is delivered from $V5IN$ supply. The instantaneous drive current is supplied by an input capacitor connected between $V5IN$ and GND . The average drive current is equal to the gate charge at $V_{GS} = 5$ V times switching frequency. This gate drive current as well as the high-side gate drive current times 5 V makes the driving power which needs to be dissipated from TPS59116 package.

High-Side Driver

The high-side driver is designed to drive high-current, low- $R_{DS(on)}$ N-channel MOSFET(s). When configured as a floating driver, 5-V bias voltage is delivered from $V5IN$ supply. The average drive current is also calculated by the gate charge at $V_{GS} = 5$ V times switching frequency. The instantaneous drive current is supplied by the flying capacitor between $VBST$ and LL pins. The drive capability is represented by its internal resistance, which are 3 Ω for $VBST$ to DRV_H and 0.9 Ω for DRV_H to LL .

Current Sensing Scheme

In order to provide both good accuracy and cost effective solution, TPS59116 supports both of external resistor sensing and MOSFET $R_{DS(on)}$ sensing. For resistor sensing scheme, an appropriate current sensing resistor should be connected between the source terminal of the bottom MOSFET and $PGND$. CS pin is connected to the MOSFET source terminal node. The inductor current is monitored by the voltage between $PGND$ pin and CS pin. For $R_{DS(on)}$ sensing scheme, CS pin should be connected to $V5FILT$ through the trip voltage setting resistor, R_{TRIP} . In this scheme, CS terminal sinks 10- μA I_{TRIP} current and the trip level is set to the voltage across the R_{TRIP} . The inductor current is monitored by the voltage between $PGND$ pin and LL pin so that LL pin should be connected to the drain terminal of the bottom MOSFET. I_{TRIP} has 4500ppm/ $^{\circ}C$ temperature slope to compensate the temperature dependency of the $R_{DS(on)}$. In either scheme, $PGND$ is used as the positive current sensing node so that $PGND$ should be connected to the proper current sensing device, i.e. the sense resistor or the source terminal of the bottom MOSFET.

PWM Frequency and Adaptive On-Time Control

TPS59116 employs adaptive on-time control scheme and does not have a dedicated oscillator on board. However, the device runs with fixed 400-kHz pseudo-constant frequency by feed-forwarding the input and output voltage into the on-time one-shot timer. The on-time is controlled inverse proportional to the input voltage and proportional to the output voltage so that the duty ratio is kept as V_{OUT}/V_{IN} technically with the same cycle time. Although the TPS59116 does not have a pin connected to VIN, the input voltage is monitored at LL pin during the ON state. This helps pin count reduction to make the part compact without sacrificing its performance. In order to secure minimum ON-time during startup, feed-forward from the output voltage is enabled after the output becomes 750 mV or larger.

VDDQ Output Voltage Selection

TPS59116 can be used for both of DDR ($V_{VDDQ} = 2.5\text{ V}$) and DDR2 ($V_{VDDQ} = 1.8\text{ V}$) power supply and adjustable output voltage ($0.75\text{ V} < V_{VDDQ} < 3\text{ V}$) by connecting VDDQSET pin as shown in [Table 1](#). Use adjustable output voltage scheme for DDR3 application.

Table 1. VDDQSET and Output Voltages

VDDQSET	VDDQ (V)	VTTREF and VTT	NOTE
GND	2.5	$V_{VDDQSNS}/2$	DDR
V5IN	1.8	$V_{VDDQSNS}/2$	DDR2
FB Resistors $R_{UP} = R_{DOWN} = 75\text{ k}\Omega$	1.5	$V_{VDDQSNS}/2$	DDR3
FB Resistors	Adjustable	$V_{VDDQSNS}/2$	$0.75\text{ V} < V_{VDDQ} < 3\text{ V}^{(1)}$

VTT Linear Regulator and VTTREF

TPS59116 integrates high performance low-dropout linear regulator that is capable of sourcing and sinking current up to 3 A. This VTT linear regulator employs ultimate fast response feedback loop so that small ceramic capacitors are enough to keep tracking the VTTREF within $\pm 40\text{ mV}$ at all conditions including fast load transient. To achieve tight regulation with minimum effect of wiring resistance, a remote sensing terminal, VTTSENS, should be connected to the positive node of VTT output capacitor(s) as a separate trace from VTT pin. For stable operation, total capacitance of the VTT output terminal can be equal to or greater than $20\text{ }\mu\text{F}$. It is recommended to attach two $10\text{-}\mu\text{F}$ ceramic capacitors in parallel to minimize the effect of ESR and ESL. If ESR of the output capacitor is greater than $2\text{ m}\Omega$, insert an RC filter between the output and the VTTSENS input to achieve loop stability. The RC filter time constant should be almost the same or slightly lower than the time constant made by the output capacitor and its ESR. VTTREF block consists of on-chip 1/2 divider, LPF and buffer. This regulator also has sink and source capability up to 10 mA. Bypass VTTREF to GND by a $0.033\text{-}\mu\text{F}$ ceramic capacitor for stable operation.

Outputs Management by S3, S5 Control

In the DDR/DDR2/DDR3 memory applications, it is important to keep VDDQ always higher than VTT/VTTREF including both start-up and shutdown. TPS59116 provides this management by simply connecting both S3 and S5 terminals to the sleep-mode signals such as SLP_S3 and SLP_S5 in the notebook PC system. All of VDDQ, VTTREF and VTT are turned on at S0 state ($S3 = S5 = \text{high}$). In S3 state ($S3 = \text{low}, S5 = \text{high}$), VDDQ and VTTREF voltages are kept on while VTT is turned off and left at high impedance (high-Z) state. The VTT output is floated and does not sink or source current in this state. In S4/S5 states ($S3 = S5 = \text{low}$), all of the three outputs are disabled. Outputs are discharged to ground according to the discharge mode selected by MODE pin (see *VDDQ and VTT Discharge Control* section). Each state code represents as follow; S0 = full ON, S3 = suspend to RAM (STR), S4 = suspend to disk (STD), S5 = soft OFF. (See [Table 2](#))

Table 2. S3 and S5 Control

STATE	S3	S5	VDDQ	VTTREF	VTT
S0	HI	HI	On	On	On
S3	LO	HI	On	On	Off (Hi-Z)
S4/S5	LO	LO	Off (Discharge)	Off (Discharge)	Off (Discharge)

(1) $V_{VDDQ} \geq 1.2\text{ V}$ when used as VLDOIN.

Soft-Start and Powergood

The soft start function of the SMPS is achieved by ramping up reference voltage and two-stage current clamp. At the starting point, the reference voltage is set to 650 mV (87% of its target value) and the overcurrent threshold is set half of the nominal value. When UVP comparator detects VDDQ become greater than 80% of the target, the reference voltage is raised toward 750 mV using internal 4-bit DAC. This takes approximately 85 μ s. The overcurrent threshold is released to nominal value at the end of this period. The powergood signal waits another 45 μ s after the reference voltage reaches 750 mV and the VDDQ voltage becomes good (above 95% of the target voltage), then turns off powergood open-drain MOSFET.

The soft-start function of the VTT LDO is achieved by current clamp. The current limit threshold is also changed in two stages using an internal powergood signal dedicated for LDO. During VTT is below the powergood threshold, the current limit level is cut into 60% (2.2 A). This allows the output capacitors to be charged with low and constant current that gives linear ramp up of the output. When the output comes up to the good state, the overcurrent limit level is released to normal value (3.8 A). TPS59116 has an independent counter for each output, but the PGOOD signal indicates only the status of VDDQ and does not indicate VTT powergood externally. See [Figure 1](#).

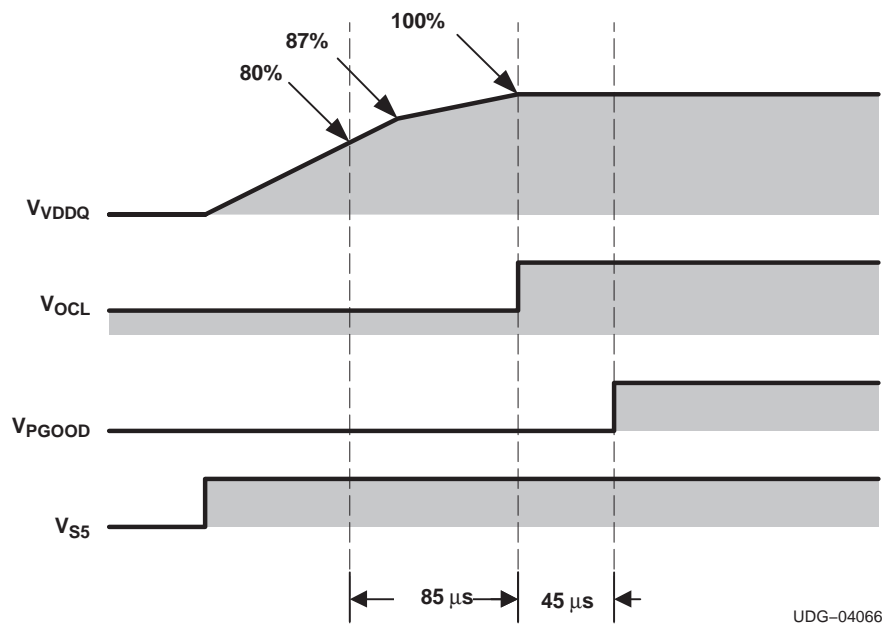

Figure 1. VDDQ Soft-Start and Powergood Timing

Soft-start duration, T_{VDDQSS} , T_{VTTSS} are functions of output capacitances.

$$t_{VDDQSS} = \frac{2 \times C_{VDDQ} \times V_{VDDQ} \times 0.8}{I_{VDDQOCP}} + 85 \mu\text{s}$$

where

- $I_{VDDQOCP}$ is the current limit value for VDDQ switcher calculated by [Equation 5](#) (2)

$$t_{VTTSS} = \frac{C_{VTT} \times V_{VTT}}{I_{VTTOCL}}$$

where

- $I_{VTTOCL} = 2.2 \text{ A (typ)}$ (3)

In each of the two previous calculations, no load current during start-up are assumed. Note that both switchers and the LDO do not start up with full load condition.

Pre-Biased Start-up

The TPS59116 allows pre-biased start-up of the VDDQ and VTT outputs without causing any undershoot or ringing in all three discharge modes. The high-side and low-side MOSFETs are kept in the turned-off condition till the internal soft-start reference increases beyond the feedback voltage at the VDDQSNS pin. The soft-start operation after this point is the same as the regular startup from a 0 V output.

If the TPS59116 is programmed to operate in no-discharge mode, the VDDQ and VTT outputs do not discharge any pre-bias voltage, but in non-tracking discharge mode there exist a slow discharge from both VDDQ as well as VTT outputs. If programmed to operate in tracking discharge mode, the VTT pin has a low impedance path that forces the voltage at VTT to half the voltage at VDDQ. Normally this creates a low-impedance pull-down from VTT to GND, if VDDQ is at 0 V.

VDDQ and VTT Discharge Control

TPS59116 discharges VDDQ, VTTREF and VTT outputs during S3 and S5 are both low. There are two different discharge modes. The discharge mode can be set by connecting MODE pin as shown in [Table 3](#).

Table 3. Discharge Selection

MODE	DISCHARGE MODE
V5IN	No discharge
VDDQ	Tracking discharge
GND	Non-tracking discharge

When in tracking-discharge mode, TPS59116 discharges outputs through the internal VTT regulator transistors and VTT output tracks half of VDDQ voltage during this discharge. Note that VDDQ discharge current flows via VLDOIN to LDOGND thus VLDOIN must be connected to VDDQ output in this mode. The internal LDO can handle up to 3 A and discharge quickly. After VDDQ is discharged down to 0.2 V, the internal LDO is turned off and the operation mode is changed to the non-tracking-discharge mode.

When in non-tracking-discharge mode, TPS59116 discharges outputs using internal MOSFETs which are connected to VDDQSNS and VTT. The current capability of these MOSFETs are limited to discharge slowly. Note that VDDQ discharge current flows from VDDQSNS to PGND in this mode. In case of no discharge mode, TPS59116 does not discharge output charge at all.

Current Protection for VDDQ

The SMPS has cycle-by-cycle overcurrent limiting control. The inductor current is monitored during the *OFF* state and the controller keeps the *OFF* state during the inductor current is larger than the overcurrent trip level. The trip level and current sense scheme are determined by CS pin connection (see *Current Sensing Scheme* section). For resistor sensing scheme, the trip level, V_{TRIP} , is fixed value of 60 mV.

For $R_{DS(on)}$ sensing scheme, CS terminal sinks 10 μ A and the trip level is set to the voltage across this R_{TRIP} resistor.

$$V_{TRIP} \text{ (mV)} = R_{TRIP} \text{ (k}\Omega\text{)} \times 10 \text{ (}\mu\text{A)} \quad (4)$$

As the comparison is done during the *OFF* state, V_{TRIP} sets valley level of the inductor current. Thus, the load current at overcurrent threshold, I_{OCP} , can be calculated as shown in [Equation 5](#).

$$I_{OCP} = \frac{V_{TRIP}}{R_{DS(on)}} + \frac{I_{RIPPLE}}{2} = \frac{V_{TRIP}}{R_{DS(on)}} + \frac{1}{2 \times L \times f} \times \frac{(V_{IN} - V_{OUT}) \times V_{OUT}}{V_{IN}} \quad (5)$$

In an overcurrent condition, the current to the load exceeds the current to the output capacitor thus the output voltage tends to fall down. If the output voltage becomes less than Powergood level, the V_{TRIP} is cut into half and the output voltage tends to be even lower. Eventually, it crosses the undervoltage protection threshold and shutdown.

Current Protection for VTT

The LDO has an internally fixed constant overcurrent limiting of 3.8 A while operating at normal condition. This trip point is reduced to 2.2 A before the output voltage comes within $\pm 5\%$ of the target voltage or goes outside of $\pm 10\%$ of the target voltage.

Overvoltage and Undervoltage Protection for VDDQ

TPS59116 monitors a resistor divided feedback voltage to detect overvoltage and undervoltage. If VDDQSET is connected to V5IN or GND, the feedback voltage is made by an internal resistor divider inside VDDQSNS pin. If an external resistor divider is connected to VDDQSET pin, the feedback voltage is VDDQSET voltage itself. When the feedback voltage becomes higher than 115% of the target voltage, the OVP comparator output goes high and the circuit latches as the top MOSFET driver OFF and the bottom MOSFET driver ON.

Also, TPS59116 monitors VDDQSNS voltage directly and if it becomes greater than 4 V TPS59116 turns off the top MOSFET driver. When the feedback voltage becomes lower than 70% of the target voltage, the UVP comparator output goes high and an internal UVP delay counter begins counting. After 32 cycles, TPS59116 latches OFF both top and bottom MOSFETs. This function is enabled after 1007 cycles of SMPS operation to ensure startup.

V5FILT Undervoltage Lockout (UVLO) Protection

TPS59116 has 5-V supply undervoltage lockout protection (UVLO). When the V5FILT voltage is lower than UVLO threshold voltage, SMPS, VTTLDO and VTTREF are shut off. This is a non-latch protection.

V5FILT Input Capacitor

Add a ceramic capacitor with a value between 1.0 μF and 4.7 μF placed close to the V5FILT pin to stabilize the 5-V input from any parasitic impedance.

Thermal Shutdown

TPS59116 monitors the temperature of itself. If the temperature exceeds the threshold value, 160°C (typ), SMPS, VTTLDO and VTTREF are shut off. This is a non-latch protection and the operation is resumed when the device is cooled down by about 10°C.

APPLICATION INFORMATION

Loop Compensation and External Parts Selection

Current Mode Operation

A buck converter using TPS59116 current mode operation can be partitioned into three portions, a voltage divider, an error amplifier and a switching modulator. By linearizing the switching modulator, we can derive the transfer function of the whole system. Since current mode scheme directly controls the inductor current, the modulator can be linearized as shown in Figure 2.

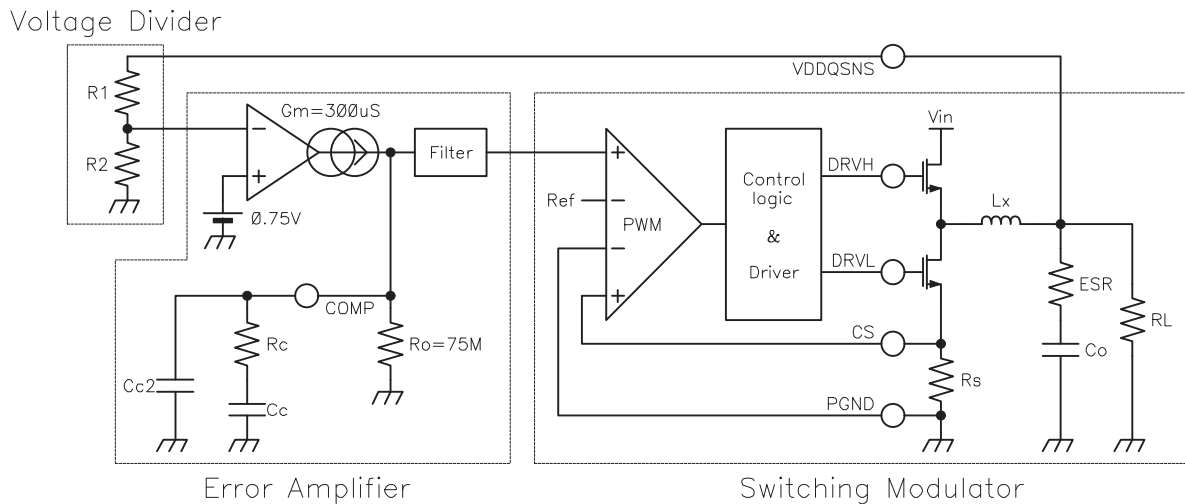

Figure 2. Linearizing the Modulator

Here, the inductor is located inside the local feedback loop and the inductance does not appear in the small signal model. As a result, a modulated current source including the power inductor can be modeled as a current source with its transconductance of $1/R_S$ and the output capacitor represent the modulator portion. This simplified model is applicable in the frequency space up to approximately a half of the switching frequency. One note is, although the inductance has no influence to small signal model, it has influence to the large signal model as it limits slew rate of the current source. This means the buck converter's load transient response, one of the large signal behaviors, can be improved by using smaller inductance without affecting the loop stability.

Total open loop transfer function of the whole system is given by Equation 6.

$$H(s) = H_1(s) \times H_2(s) \times H_3(s) \quad (6)$$

Assuming $R_L \gg ESR$, $R_O \gg R_C$ and $C_C \gg C_{C2}$, each transfer function of the three blocks is shown starting with Equation 7.

$$H_1(s) = \frac{R_2}{(R_2 + R_1)} \quad (7)$$

$$H_2(s) = -gm \times \frac{R_O (1 + s \times C_C \times R_C)}{(1 + s \times C_C \times R_O)(1 + s \times C_{C2} \times R_C)} \quad (8)$$

$$H_3(s) = \frac{(1 + s \times C_O \times ESR)}{(1 + s \times C_O \times R_L)} \times \frac{R_L}{R_S} \quad (9)$$

There are three poles and two zeros in $H(s)$. Each pole and zero is given by the following five equations.

$$\omega_{P1} = \frac{1}{(C_C \times R_O)} \quad (10)$$

$$\omega_{P2} = \frac{1}{(C_O \times R_L)} \quad (11)$$

$$\omega_{P3} = \frac{1}{(C_{C2} \times R_C)} \quad (12)$$

$$\omega_{Z1} = \frac{1}{(C_C \times R_C)} \quad (13)$$

$$\omega_{Z2} = \frac{1}{(C_O \times ESR)} \quad (14)$$

Usually, each frequency of those poles and zeros is lower than the 0 dB frequency, f_0 . However, the f_0 should be kept under 1/3 of the switching frequency to avoid effect of switching circuit delay. The f_0 is given by [Equation 15](#).

$$f_0 = \frac{1}{2\pi} \times \frac{R_2}{(R_1 + R_2)} \times \frac{g_M}{C_O} \times \frac{R_C}{R_S} = \frac{1}{2\pi} \times \frac{0.75}{V_{OUT}} \times \frac{g_M}{C_O} \times \frac{R_C}{R_S} \quad (15)$$

Based on small signal analysis above, the external components can be selected by following manner.

1. **Choose the inductor.** The inductance value should be determined to give the ripple current of approximately 1/4 to 1/2 of maximum output current.

$$L = \frac{1}{I_{IND(ripple)} \times f} \times \frac{(V_{IN(max)} - V_{OUT}) \times V_{OUT}}{V_{IN(max)}} = \frac{2}{I_{OUT(max)} \times f} \times \frac{(V_{IN(max)} - V_{OUT}) \times V_{OUT}}{V_{IN(max)}} \quad (16)$$

The inductor also needs to have low DCR to achieve good efficiency, as well as enough room above peak inductor current before saturation. The peak inductor current can be estimated as shown in [Equation 17](#).

$$I_{IND(peak)} = \frac{V_{TRIP}}{R_{DS(on)}} + \frac{1}{L \times f} \times \frac{(V_{IN(max)} - V_{OUT}) \times V_{OUT}}{V_{IN(max)}} \quad (17)$$

2. **Choose rectifying (bottom) MOSFET.** When $R_{DS(on)}$ sensing scheme is selected, the rectifying MOSFET's on-resistance is used as this R_S so that lower $R_{DS(on)}$ does not always promise better performance. In order to clearly detect inductor current, minimum R_S recommended is to give 15 mV or larger ripple voltage with the inductor ripple current. This promises smooth transition from CCM to DCM or vice versa. Upper side of the $R_{DS(on)}$ is of course restricted by the efficiency requirement, and usually this resistance affects efficiency more at high-load conditions. When using external resistor current sensing, there is no restriction for low $R_{DS(on)}$. However, the current sensing resistance R_S itself affects the efficiency.
3. **Choose output capacitor(s).** In cases of organic semiconductor capacitors (OS-CON) or specialty polymer capacitors (SP-CAP), ESR to achieve required ripple value at stable state or transient load conditions determines the amount of capacitor(s) need, and capacitance is then enough to satisfy stable operation. The peak-to-peak ripple value can be estimated by ESR times the inductor ripple current for stable state, or ESR times the load current step for a fast transient load response. In case of ceramic capacitor(s), usually ESR is small enough to meet ripple requirement. On the other hand, transient undershoot and overshoot driven by output capacitance becomes the key factor to determine the capacitor(s).
4. **Determine f_0 and calculate R_C** using [Equation 18](#). Note that higher R_C shows faster transient response in cost of unstableness. If the transient response is not enough even with high R_C value, try increasing the output capacitance. Recommended f_0 is $f_{OSC}/4$. Then R_C can be derived by [Equation 19](#).

$$R_C \leq 2\pi \times f_0 \times \frac{V_{OUT}}{0.75} \times \frac{C_O}{g_M} \times R_S \quad (18)$$

$$R_C = 2.8 \times V_{OUT} \times C_O [\mu F] \times R_S [m\Omega] \quad (19)$$

5. **Calculate C_{C2}** . This capacitance cancels the zero caused by ESR of the output capacitor. When using ceramic capacitor(s), there is no need for C_{C2} .

$$\omega_{Z2} = \frac{1}{(C_O \times ESR)} = \omega_{P3} = \frac{1}{(C_{C2} \times R_C)} \quad (20)$$

$$C_{C2} = \frac{(C_O \times ESR)}{R_C} \quad (21)$$

6. **Calculate C_C .** The purpose of C_C is to reduce the DC component to obtain high DC feedback gain. However, as it causes phase delay, another zero is needed to cancel this effect. This zero, ω_{z1} , is determined by C_C and R_C . It is recommended that ω_{z1} be 10 times lower than the f_0 frequency.

$$f_{z1} = \frac{1}{2\pi \times C_C \times R_C} = \frac{f_0}{10} \quad (22)$$

7. **When using adjustable mode, determine the value of R1 and R2.**

$$R1 = \frac{V_{OUT} - 0.75}{0.75} \times R2 \quad (23)$$

D-CAP™ Mode Operation

A buck converter system using D-CAP™ Mode can be simplified as below.

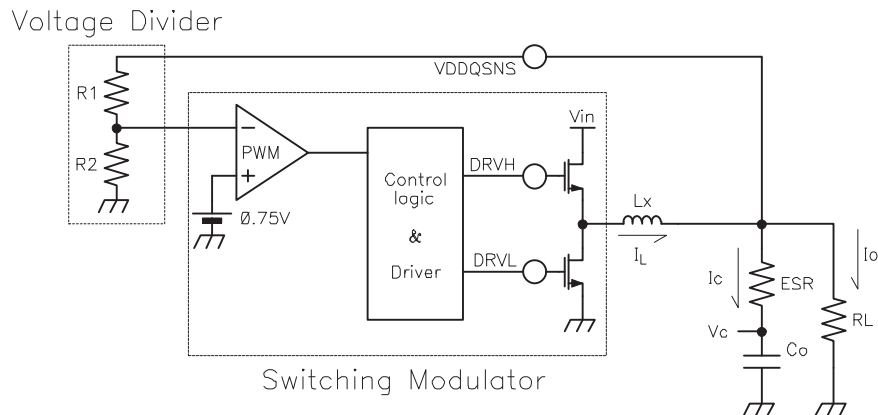

Figure 3. Linearizing the Modulator

The VDDQSNS voltage is compared to the internal reference voltage after divider resistors. The PWM comparator determines the time to turn-on the top MOSFET. The gain and speed of the comparator is high enough to keep the voltage at the beginning of each on cycle (or the end of each off cycle) substantially constant. The DC output voltage may have line regulation due to ripple amplitude that slightly increases as the input voltage increase.

For loop stability, the 0-dB frequency, f_0 , defined in Equation 24 needs to be lower than 1/3 of the switching frequency.

$$f_0 = \frac{1}{2\pi \times ESR \times C_O} \leq \frac{f_{SW}}{3} \quad (24)$$

As f_0 is determined solely by the output capacitor characteristics, loop stability of D-CAP™ mode is determined by the capacitor chemistry. For example, specialty polymer capacitors (SP-CAP) have C_O in the order of several 100 μ F and have an ESR in the range of 10 m Ω . This makes f_0 on the order of 100 kHz or less and the loop is then stable. However, ceramic capacitors have an f_0 of more than 700 kHz, which is not suitable for this operational mode.

Although D-CAP™ mode provides many advantages such as ease-of-use, minimum external components configuration and extremely short response time, because there is no error amplifier in the loop, a sufficient amount of feedback signal needs to be provided by an external circuit to reduce jitter level.

The required signal level is approximately 15 mV at the comparing point. This gives $V_{RIPPLE} = (V_{OUT}/0.75) \times 15$ (mV) at the output node. The output capacitor ESR should meet this requirement.

The external components selection is much more simple in D-CAP™ mode.

1. **Choose inductor.** This section is the same as the current mode. Please refer to the instructions in the *Current Mode Operation* section.
2. **Choose output capacitor(s).** Organic semiconductor capacitor(s) or specialty polymer capacitor(s) are recommended. Determine an ESR to meet the required ripple voltage. A quick approximation is shown in [Equation 25](#).

$$\text{ESR} = \frac{V_{\text{OUT}} \times 0.015}{I_{\text{RIPPLE}} \times 0.75} \approx \frac{V_{\text{OUT}}}{I_{\text{OUT(max)}}} \times 60 \text{ [m}\Omega\text{]} \quad (25)$$

Thermal Design

Primary power dissipation of the TPS59116 is generated from the VTT regulator. The VTT current flow in both source and sink directions generates power dissipation from the device. In the source phase, the potential difference between VLDOIN and VTT times VTT current becomes the power dissipation, W_{DSRC} .

$$W_{\text{DSRC}} = (V_{\text{VLDOIN}} - V_{\text{VTT}}) \times I_{\text{VTT}} \quad (26)$$

In this case, if VLDOIN is connected to an alternative power supply lower than VDDQ voltage, power loss can be decreased.

For the sink phase, VTT voltage is applied across the internal LDO regulator, and the power dissipation, W_{DSNK} , is calculated by [Equation 27](#):

$$W_{\text{DSNK}} = V_{\text{VTT}} \times I_{\text{VTT}} \quad (27)$$

Because this device does not sink AND source the current at the same time and I_{VTT} varies rapidly with time, the actual power dissipation that must be considered for thermal design is an average of W_{DSNK} . Another power consumption is the current used for internal control circuitry from V5IN supply and VLDOIN supply. V5IN supports both the internal circuit and external MOSFETs drive current. The former current is in the VLDOIN supply can be estimated as 1.5 mA or less at normal operational conditions.

These powers need to be effectively dissipated from the package. Maximum power dissipation allowed to the package is calculated by [Equation 28](#),

$$W_{\text{PKG}} = \frac{T_{\text{J(max)}} - T_{\text{A(max)}}}{\theta_{\text{JA}}} \quad (28)$$

where

- $T_{\text{J(max)}}$ is 125°C
- $T_{\text{A(max)}}$ is the maximum ambient temperature in the system
- θ_{JA} is the thermal resistance from the silicon junction to the ambient

This thermal resistance strongly depends on the board layout. TPS59116 is assembled in a thermally enhanced PowerPAD™ package that has exposed die pad underneath the body. For improved thermal performance, this die pad needs to be attached to ground trace via thermal land on the PCB. This ground trace acts as a heat sink/spread. The typical thermal resistance, 39.6°C/W, is achieved based on a 6.5 mm × 3.4 mm thermal land with eight vias without air flow. It can be improved by using larger thermal land and/or increasing vias number. Further information about PowerPAD™ and its recommended board layout is described in (SLMA002). This document is available at <http://www.ti.com>.

Layout Considerations

Certain points must be considered before designing a layout using the TPS59116.

- The PCB trace is defined as LL node, which connects to the source of the switching MOSFET, the drain of the rectifying MOSFET and the high-voltage side of the inductor, should be as short and wide as possible.
- Consider adding a small snubber circuit, consisting of 3 Ω and 1 nF, between LL and PGND in case a high-frequency ringing is observed on the LL voltage waveform.
- All sensitive analog traces such as VDDQSNS, VTTSNS and CS should be placed away from high-voltage switching nodes such as LL, DRVL or DRVH nodes to avoid coupling.
- VLDOIN should be connected to VDDQ output with a short and wide trace. If a different power source is used for VLDOIN, an input bypass capacitor should be placed to the pin as close as possible with a short and wide connection.
- The output capacitor for VTT should be placed as close as possible to the pin with a short and wide connection in order to avoid additional ESR and/or ESL of the trace.
- VTTSNS should be connected to the positive node of VTT output capacitor(s) as a separate trace from the high-current power line and is strongly recommended to avoid additional ESR and/or ESL. If it is needed to sense the voltage of the point of the load, it is recommended to attach the output capacitor(s) at that point. Also, it is recommended to minimize any additional ESR and/or ESL of ground trace between GND pin and the output capacitor(s).
- Consider adding LPF at VTTSNS in case ESR of the VTT output capacitor(s) is larger than 2 mΩ.
- VDDQSNS can be connected separately from VLDOIN. Remember that this sensing potential is the reference voltage of VTTREF. Avoid any noise generative lines.
- Negative node of VTT output capacitor(s) and VTTREF capacitor should be tied together by avoiding common impedance to the high current path of the VTT source/sink current.
- GND (Signal GND) pin node represents the reference potential for VTTREF and VTT outputs. Connect GND to negative nodes of VTT capacitor(s), VTTREF capacitor and VDDQ capacitor(s) with care to avoid additional ESR and/or ESL. GND and PGND (power ground) should be connected together at a single point.
- Connect CS_GND (RGE) to source of rectifying MOSFET using Kevin connection. Avoid common trace for high-current paths such as the MOSFET to the output capacitors or the PGND to the MOSFET trace. In case of using external current sense resistor, apply the same care and connect it to the positive side (ground side) of the resistor.
- PGND is the return path for rectifying MOSFET gate drive. Use 0.65 mm (25mil) or wider trace. Connect to source of rectifying MOSFET with shortest possible path.
- Place a V5FILT filter capacitor (RGE) close to the TPS59116, within 12 mm (0.5 inches) if possible.
- The trace from the CS pin should avoid high-voltage switching nodes such as those for LL, VBST, DRVH, DRVL or PGOOD.
- In order to effectively remove heat from the package, prepare thermal land and solder to the package's thermal pad. Wide trace of the component-side copper, connected to this thermal land, helps heat spreading. Numerous vias with a 0.33-mm diameter connected from the thermal land to the internal/solder-side ground plane(s) should be used to help dissipation. **Do NOT connect PGND to this thermal land pad underneath the package.**

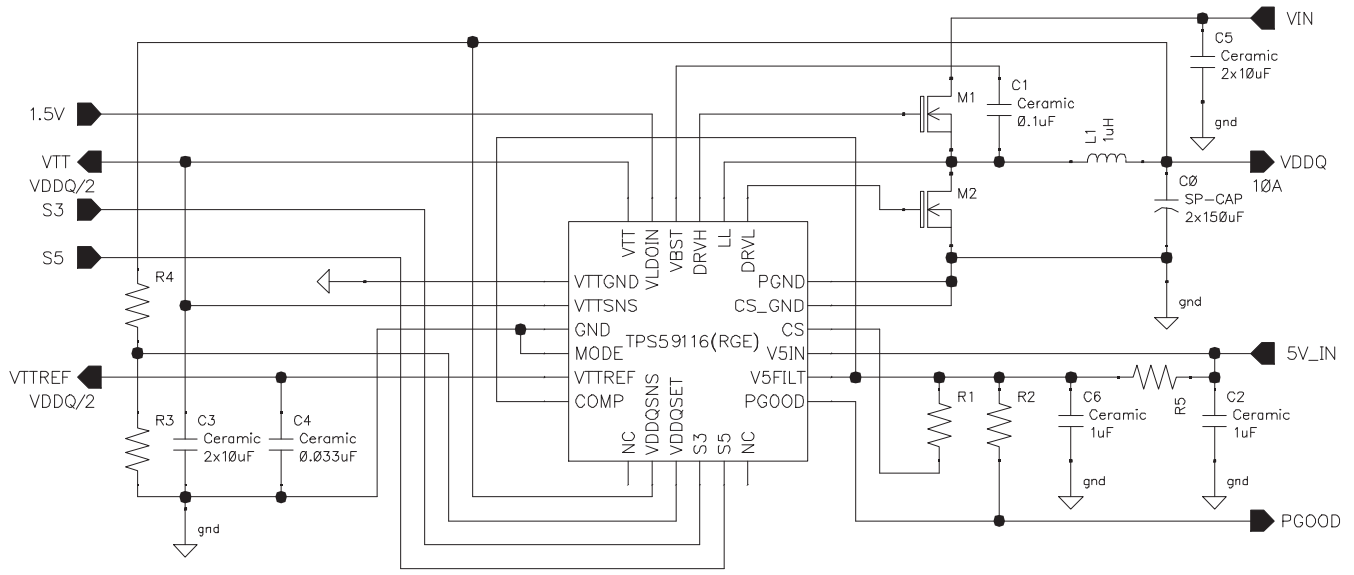

DCAP mode, VDDQ=adjustable, Rds(on) Sense, External LDOIN, Non-tracking Discharge

Figure 4. D-CAP™ Mode

Table 4. D-CAP™ Mode Schematic Components

SYMBOL	SPECIFICATION	MANUFACTURER	PART NUMBER
R1	5.1 kΩ	-	
R2	100 kΩ	-	
R3	75 kΩ	-	
R4	$(100 \times V_{DDQ} - 75) \text{ k}\Omega$	-	
R5	5.1 Ω		
M1	30 V, 13 mΩ	International Rectifier	IRF7821
M2	30 V, 5 mΩ	International Rectifier	IRF7832

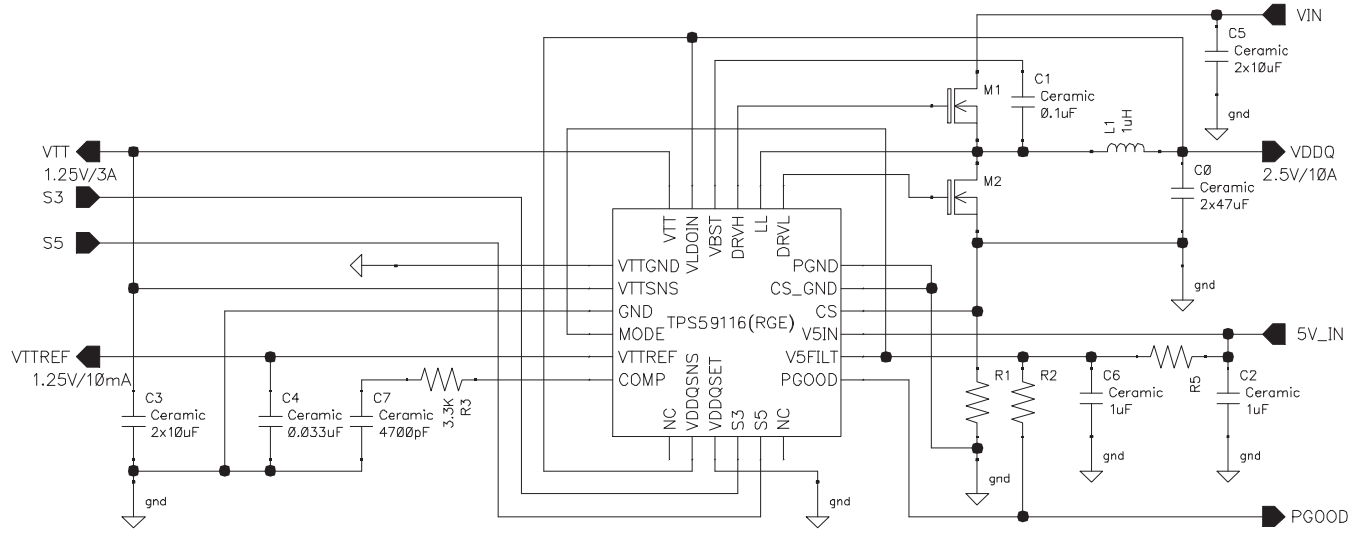

VDDQ=2.5V (DDR), Current mode, Rsense, No Discharge

Figure 5. Current Mode

Table 5. Current Mode Schematic Components

SYMBOL	SPECIFICATION	MANUFACTURER	PART NUMBER
R1	6 mΩ, 1%	Vishay	WSL-2521 0.006
R2	100 kΩ	-	-
R5	5.1 Ω		
M0	30 V, 13 mΩ	International Rectifier	IRF7821
M1	30 V, 5 mΩ	International Rectifier	IRF7832

TYPICAL CHARACTERISTICS

**V5IN+V5FILT SUPPLY CURRENT
vs
JUNCTION TEMPERATURE**

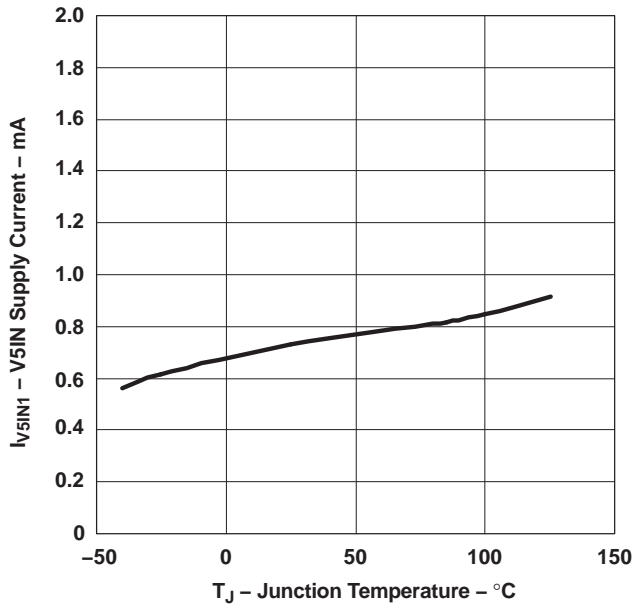

Figure 6.

**V5IN+V5FILT SHUTDOWN CURRENT
vs
JUNCTION TEMPERATURE**

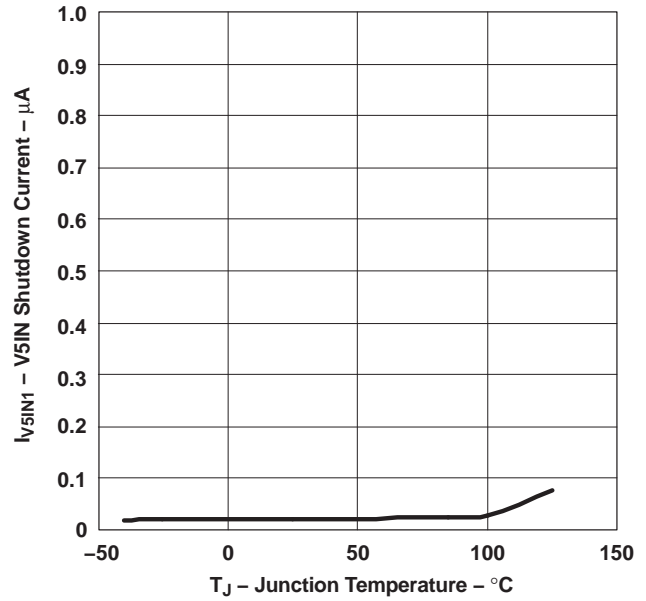

Figure 7.

**V5IN+V5FILT SUPPLY CURRENT
vs
LOAD CURRENT**

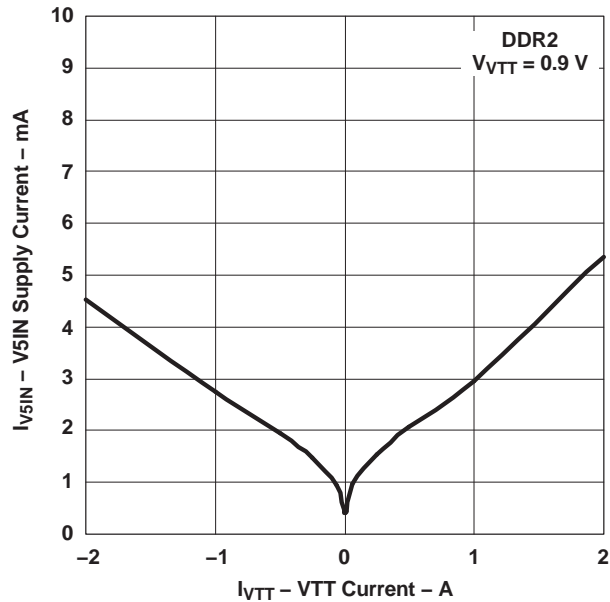

Figure 8.

**VLDOIN SUPPLY CURRENT
vs
TEMPERATURE**

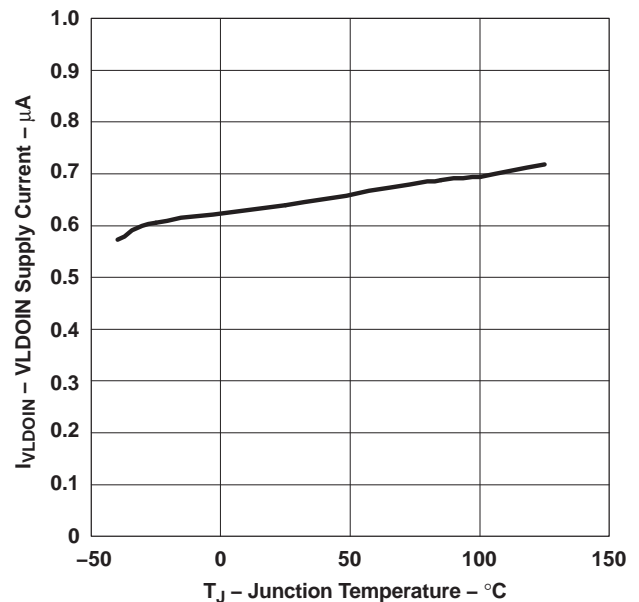

Figure 9.

TYPICAL CHARACTERISTICS (continued)

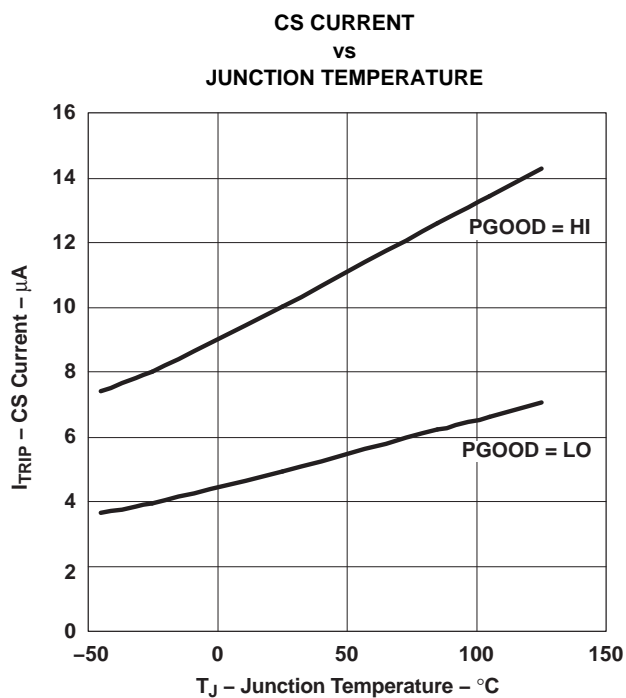

Figure 10.

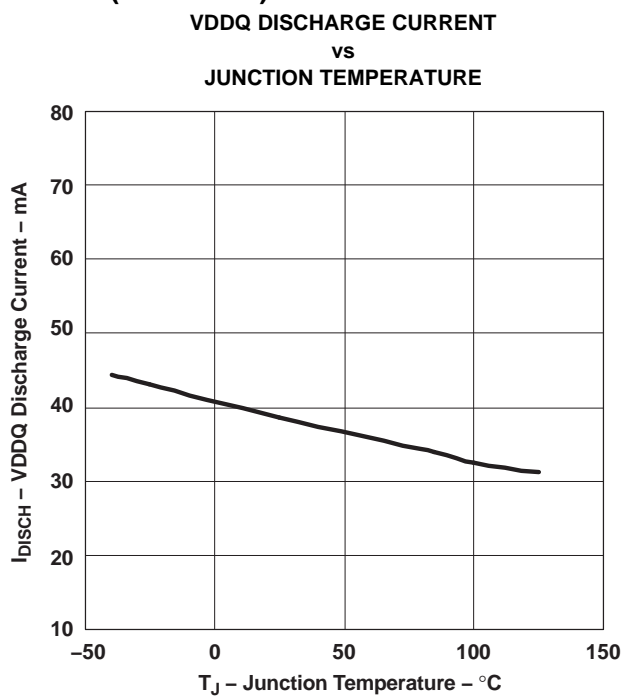

Figure 11.

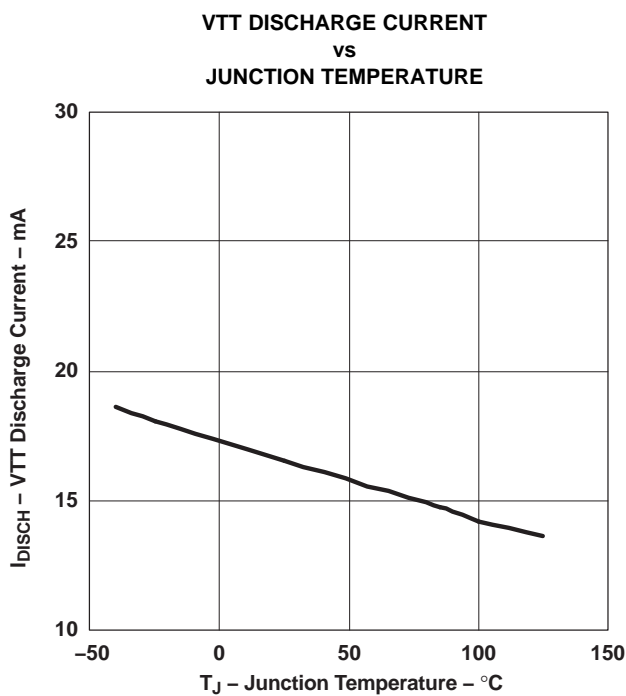

Figure 12.

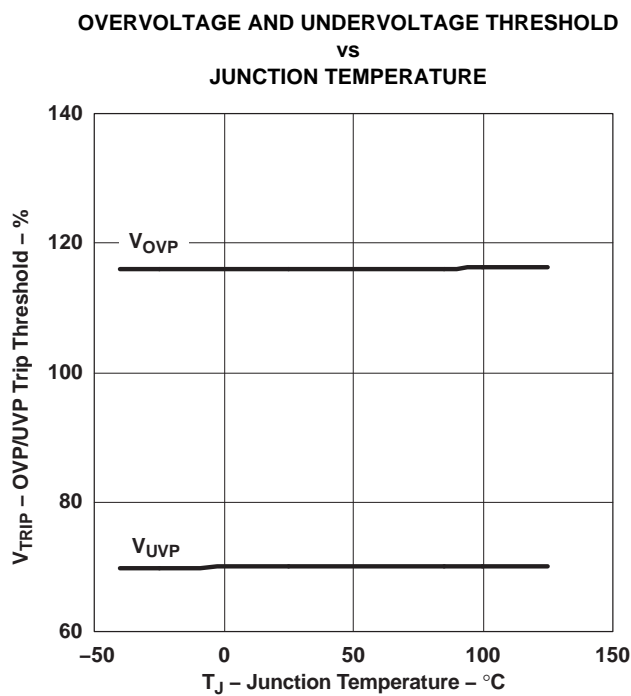

Figure 13.

TYPICAL CHARACTERISTICS (continued)

**SWITCHING FREQUENCY
vs
INPUT VOLTAGE**

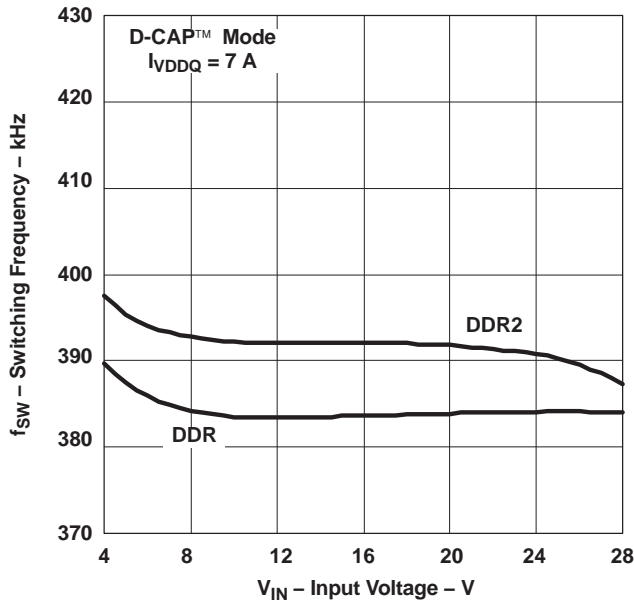

Figure 14.

**SWITCHING FREQUENCY
vs
OUTPUT CURRENT**

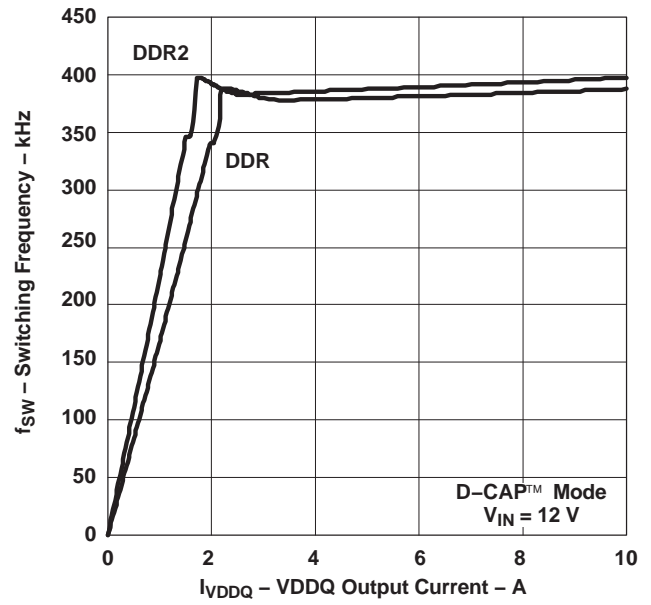

Figure 15.

**VDDQ OUTPUT VOLTAGE
vs
OUTPUT CURRENT (DDR)**

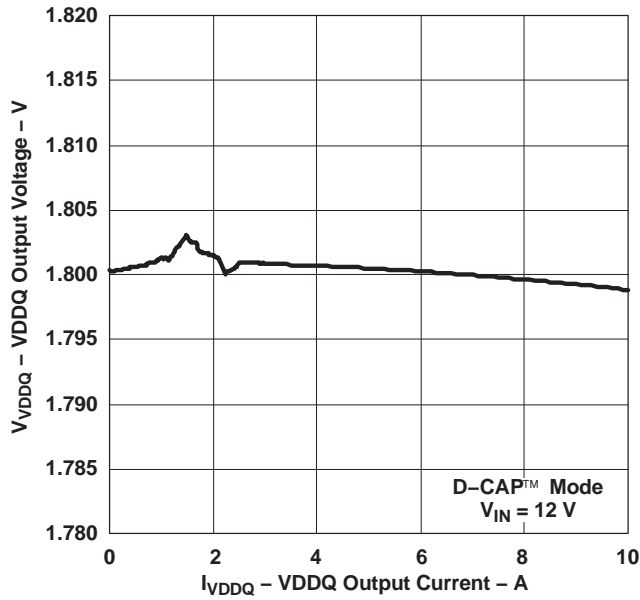

Figure 16.

**VDDQ OUTPUT VOLTAGE
vs
INPUT VOLTAGE (DDR2)**

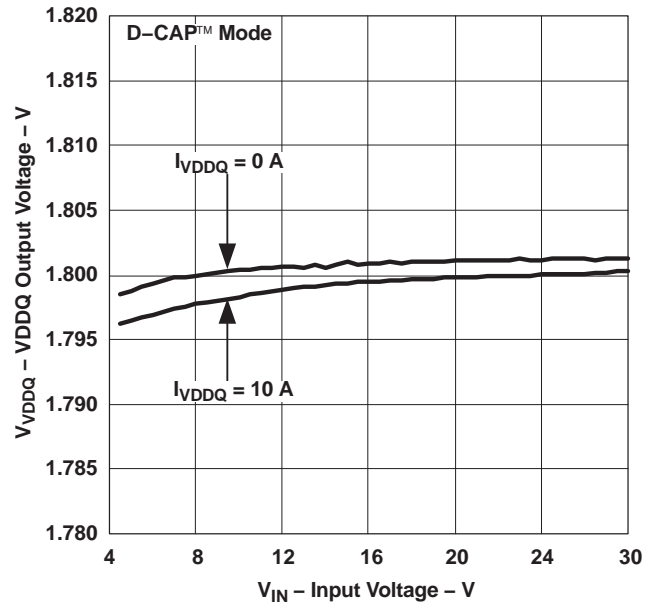

Figure 17.

TYPICAL CHARACTERISTICS (continued)

VTT OUTPUT VOLTAGE
vs
OUTPUT CURRENT (DDR)

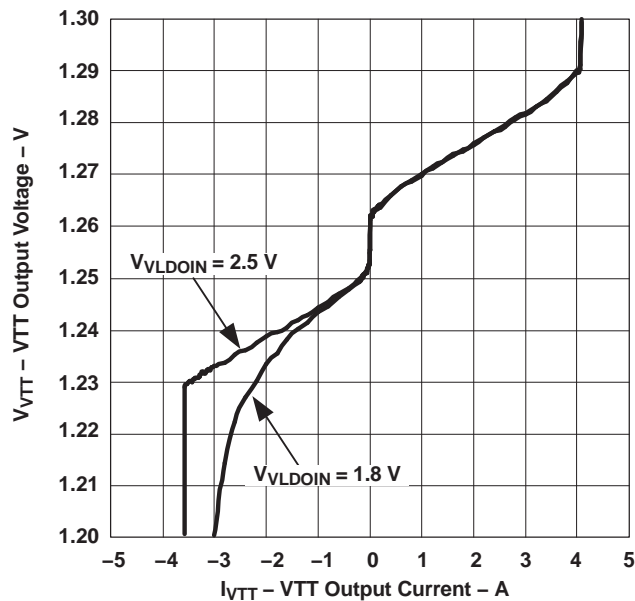

Figure 18.

VTT OUTPUT VOLTAGE
vs
OUTPUT CURRENT (DDR2)

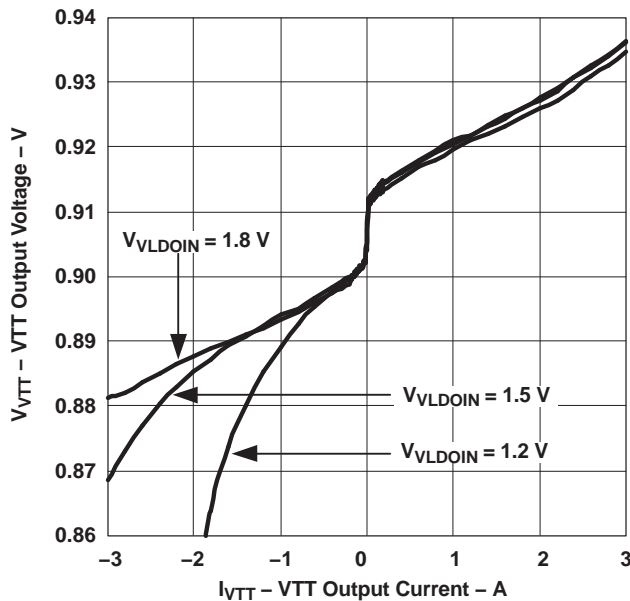

Figure 19.

VTTREF OUTPUT VOLTAGE
vs
OUTPUT CURRENT (DDR)

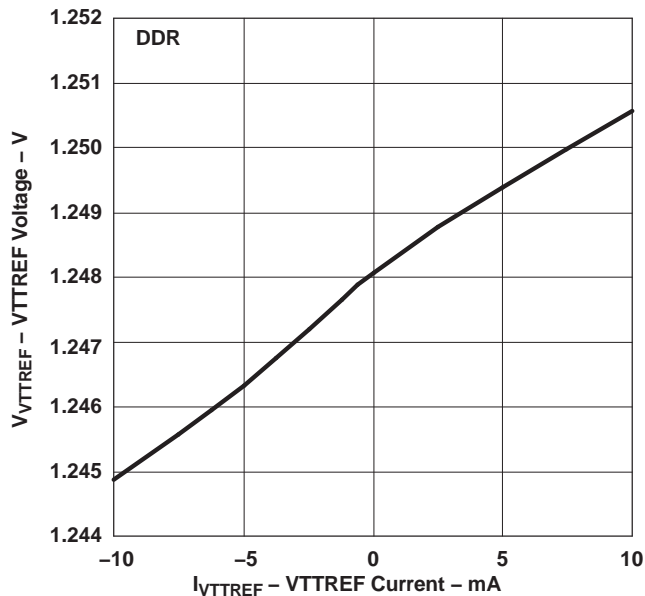

Figure 20.

VTTREF OUTPUT VOLTAGE
vs
OUTPUT CURRENT (DDR2)

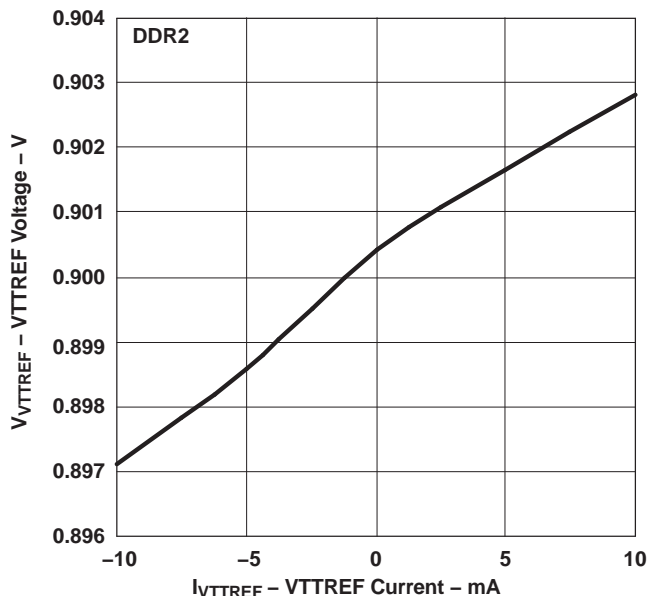

Figure 21.

TYPICAL CHARACTERISTICS (continued)

**VTTREF OUTPUT VOLTAGE
vs
OUTPUT CURRENT (DDR3)**

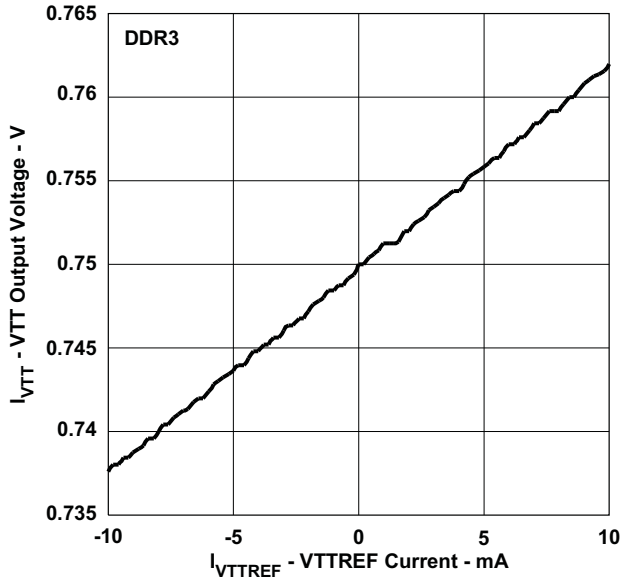

Figure 22.

**VTT OUTPUT VOLTAGE
vs
OUTPUT CURRENT (DDR3)**

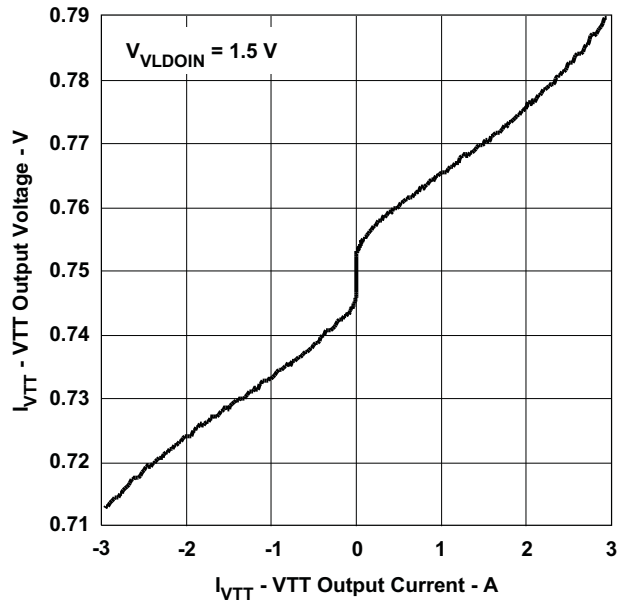

Figure 23.

**VDDQ EFFICIENCY (DDR)
vs
VDDQ CURRENT**

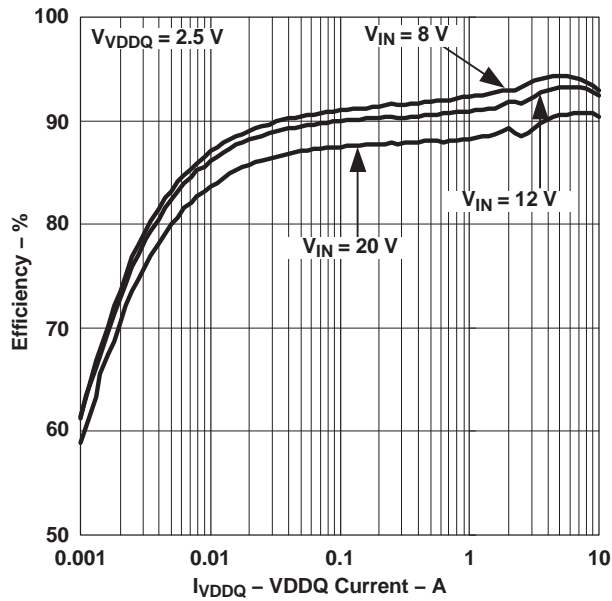

Figure 24.

**VDDQ EFFICIENCY (DDR2)
vs
VDDQ CURRENT**

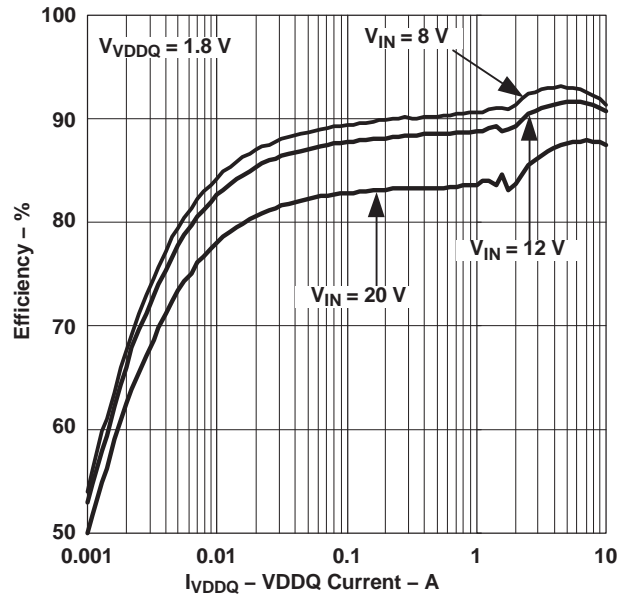
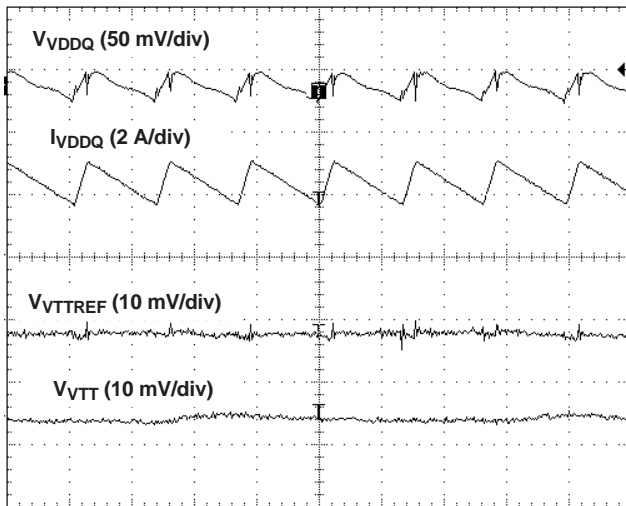

Figure 25.

TYPICAL CHARACTERISTICS (continued)



t – Time – 2 μ s/div

Figure 26. Ripple Waveforms - Heavy Load Condition

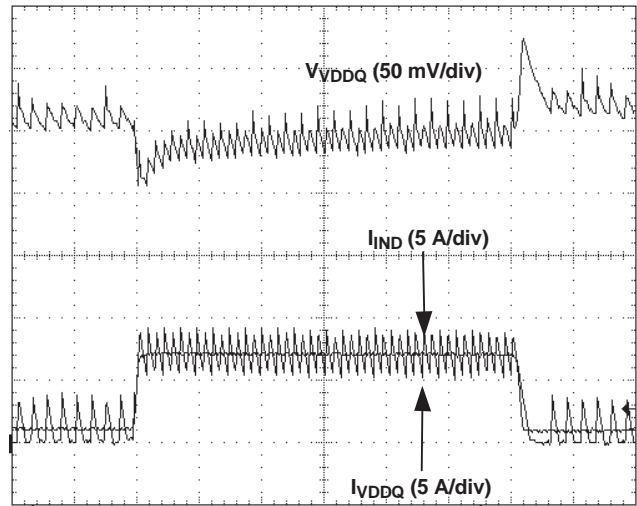

t – Time – 20 μ s/div

Figure 27. VDDQ Load Transient Response

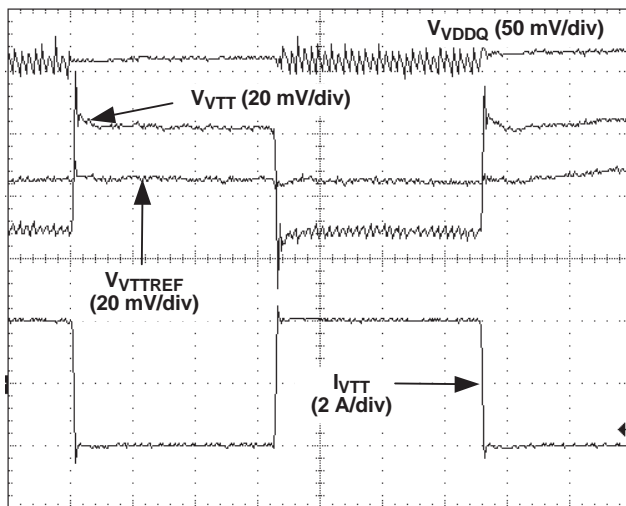

t – Time – 20 μ s/div

Figure 28. VTT Load Transient Response

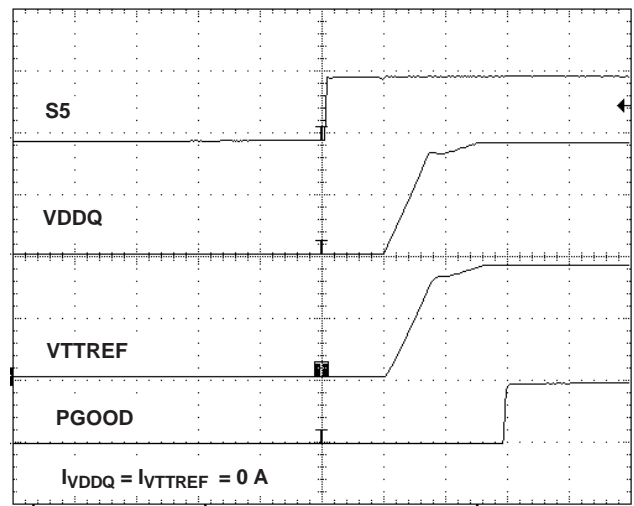

t – Time – 100 μ s/div

Figure 29. VDDQ, VTT, and VTTREF Start-Up Waveforms

TYPICAL CHARACTERISTICS (continued)

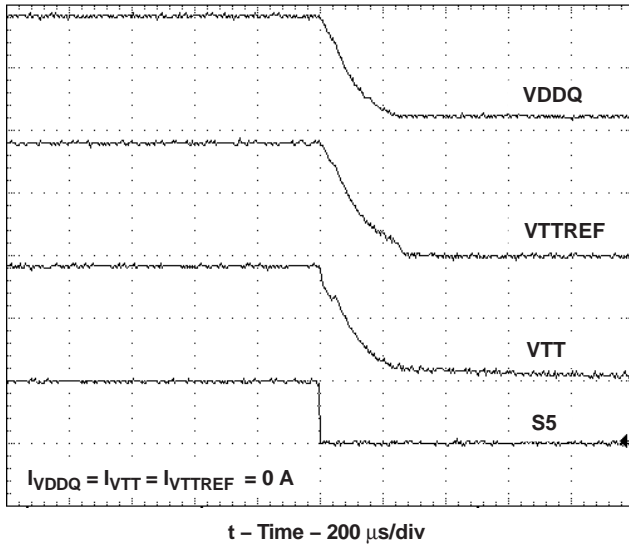

Figure 30. Soft-Start Waveforms Tracking Discharge

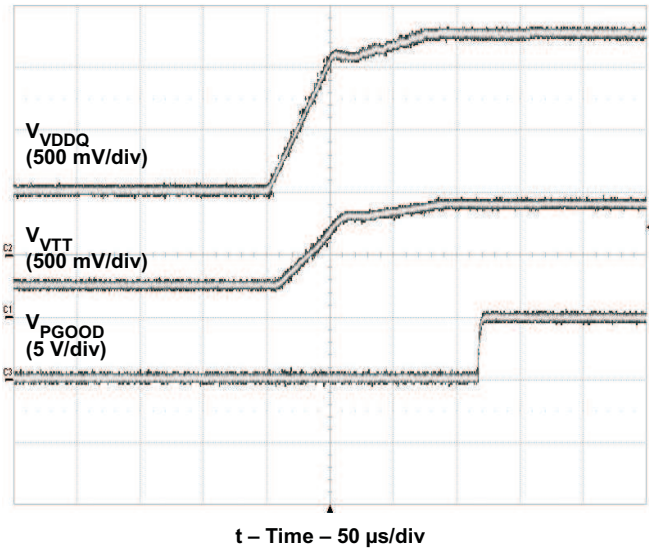

Figure 31. Pre-Biased Start-Up: VDDQ, VTT, and PGOOD

VDDQ BODE PLOT (CURRENT MODE)
GAIN AND PHASE
vs
FREQUENCY

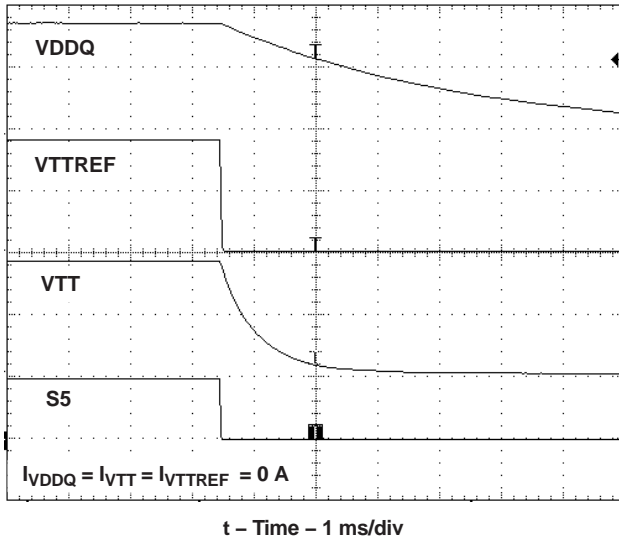

Figure 32. Soft-Stop Waveforms Non-Tracking Discharge

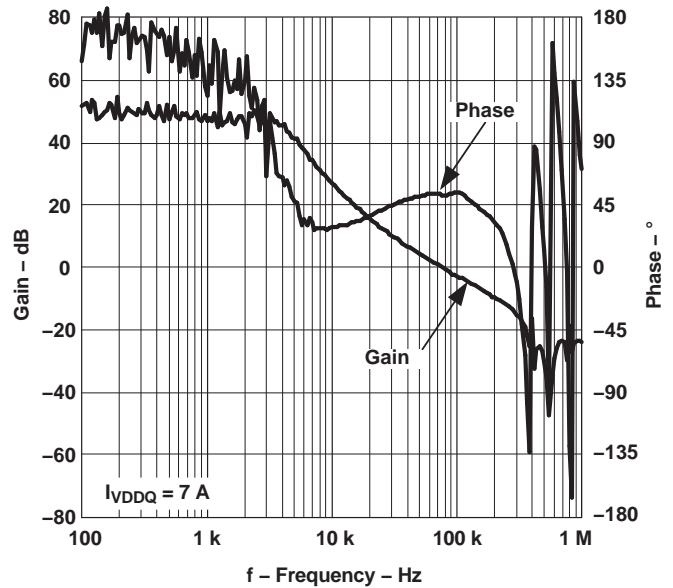

Figure 33.

TYPICAL CHARACTERISTICS (continued)

VTT BODE PLOT, SOURCE (DDR2)
GAIN AND PHASE
vs
FREQUENCY

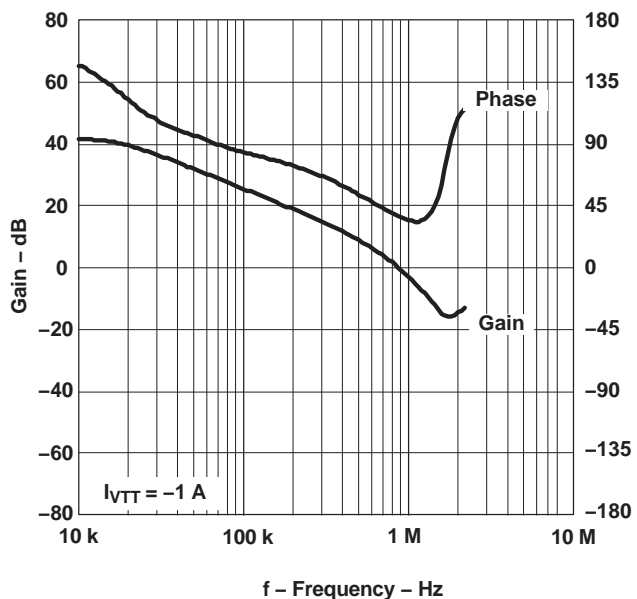

Figure 34.

VTT BODE PLOT, SINK (DDR2)
GAIN AND PHASE
vs
FREQUENCY

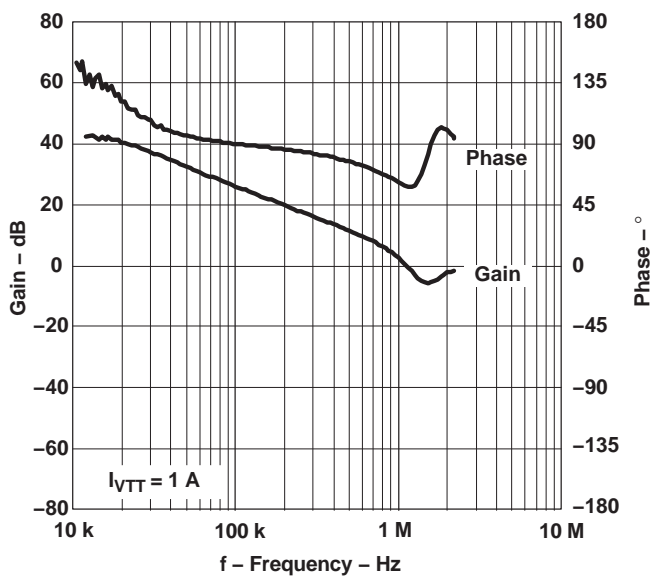

Figure 35.

PACKAGING INFORMATION

Orderable Device	Status (1)	Package Type	Package Drawing	Pins	Package Qty	Eco Plan (2)	Lead/Ball Finish	MSL Peak Temp (3)	Op Temp (°C)	Top-Side Markings (4)	Samples
TPS59116RGER	ACTIVE	VQFN	RGE	24	3000	Green (RoHS & no Sb/Br)	CU NIPDAU	Level-2-260C-1 YEAR	-40 to 85	TPS 59116	Samples
TPS59116RGET	ACTIVE	VQFN	RGE	24	250	Green (RoHS & no Sb/Br)	CU NIPDAU	Level-2-260C-1 YEAR	-40 to 85	TPS 59116	Samples

(1) The marketing status values are defined as follows:

ACTIVE: Product device recommended for new designs.

LIFEBUY: TI has announced that the device will be discontinued, and a lifetime-buy period is in effect.

NRND: Not recommended for new designs. Device is in production to support existing customers, but TI does not recommend using this part in a new design.

PREVIEW: Device has been announced but is not in production. Samples may or may not be available.

OBSOLETE: TI has discontinued the production of the device.

(2) Eco Plan - The planned eco-friendly classification: Pb-Free (RoHS), Pb-Free (RoHS Exempt), or Green (RoHS & no Sb/Br) - please check <http://www.ti.com/productcontent> for the latest availability information and additional product content details.

TBD: The Pb-Free/Green conversion plan has not been defined.

Pb-Free (RoHS): TI's terms "Lead-Free" or "Pb-Free" mean semiconductor products that are compatible with the current RoHS requirements for all 6 substances, including the requirement that lead not exceed 0.1% by weight in homogeneous materials. Where designed to be soldered at high temperatures, TI Pb-Free products are suitable for use in specified lead-free processes.

Pb-Free (RoHS Exempt): This component has a RoHS exemption for either 1) lead-based flip-chip solder bumps used between the die and package, or 2) lead-based die adhesive used between the die and leadframe. The component is otherwise considered Pb-Free (RoHS compatible) as defined above.

Green (RoHS & no Sb/Br): TI defines "Green" to mean Pb-Free (RoHS compatible), and free of Bromine (Br) and Antimony (Sb) based flame retardants (Br or Sb do not exceed 0.1% by weight in homogeneous material)

(3) MSL, Peak Temp. -- The Moisture Sensitivity Level rating according to the JEDEC industry standard classifications, and peak solder temperature.

(4) Multiple Top-Side Markings will be inside parentheses. Only one Top-Side Marking contained in parentheses and separated by a "~" will appear on a device. If a line is indented then it is a continuation of the previous line and the two combined represent the entire Top-Side Marking for that device.

Important Information and Disclaimer: The information provided on this page represents TI's knowledge and belief as of the date that it is provided. TI bases its knowledge and belief on information provided by third parties, and makes no representation or warranty as to the accuracy of such information. Efforts are underway to better integrate information from third parties. TI has taken and continues to take reasonable steps to provide representative and accurate information but may not have conducted destructive testing or chemical analysis on incoming materials and chemicals. TI and TI suppliers consider certain information to be proprietary, and thus CAS numbers and other limited information may not be available for release.

In no event shall TI's liability arising out of such information exceed the total purchase price of the TI part(s) at issue in this document sold by TI to Customer on an annual basis.

TAPE AND REEL INFORMATION



QUADRANT ASSIGNMENTS FOR PIN 1 ORIENTATION IN TAPE



*All dimensions are nominal

Device	Package Type	Package Drawing	Pins	SPQ	Reel Diameter (mm)	Reel Width W1 (mm)	A0 (mm)	B0 (mm)	K0 (mm)	P1 (mm)	W (mm)	Pin1 Quadrant
TPS59116RGER	VQFN	RGE	24	3000	330.0	12.4	4.25	4.25	1.15	8.0	12.0	Q2
TPS59116RGET	VQFN	RGE	24	250	180.0	12.4	4.25	4.25	1.15	8.0	12.0	Q2

TAPE AND REEL BOX DIMENSIONS

*All dimensions are nominal

Device	Package Type	Package Drawing	Pins	SPQ	Length (mm)	Width (mm)	Height (mm)
TPS59116RGER	VQFN	RGE	24	3000	367.0	367.0	35.0
TPS59116RGET	VQFN	RGE	24	250	210.0	185.0	35.0

RGE (S-PVQFN-N24)

PLASTIC QUAD FLATPACK NO-LEAD

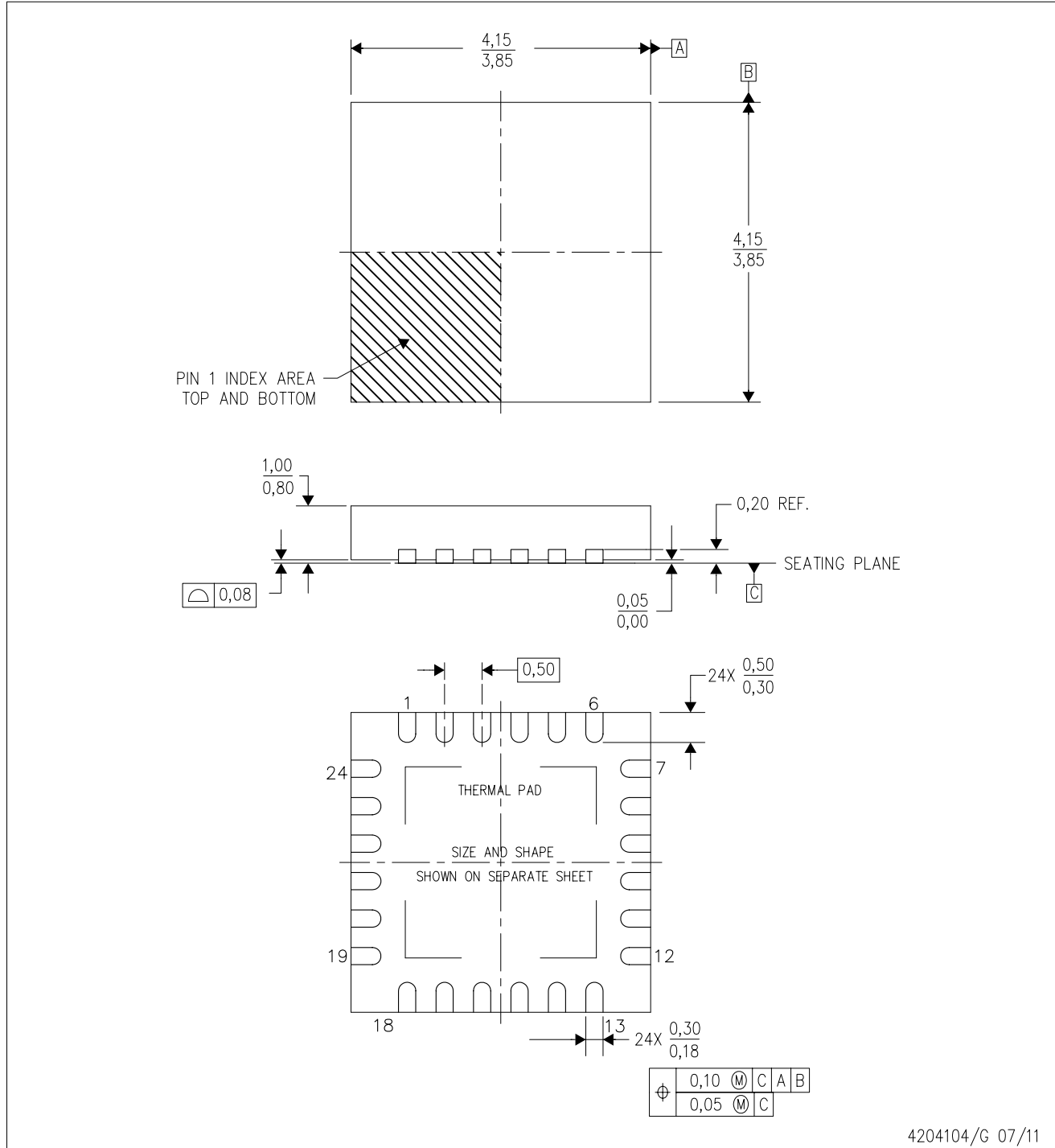

4204104/G 07/11

- NOTES:
- All linear dimensions are in millimeters. Dimensioning and tolerancing per ASME Y14.5M-1994.
 - This drawing is subject to change without notice.
 - Quad Flatpack, No-Leads (QFN) package configuration.
 - The package thermal pad must be soldered to the board for thermal and mechanical performance.
 - See the additional figure in the Product Data Sheet for details regarding the exposed thermal pad features and dimensions.
 - Falls within JEDEC MO-220.

THERMAL PAD MECHANICAL DATA

RGE (S-PVQFN-N24)

PLASTIC QUAD FLATPACK NO-LEAD

THERMAL INFORMATION

This package incorporates an exposed thermal pad that is designed to be attached directly to an external heatsink. The thermal pad must be soldered directly to the printed circuit board (PCB). After soldering, the PCB can be used as a heatsink. In addition, through the use of thermal vias, the thermal pad can be attached directly to the appropriate copper plane shown in the electrical schematic for the device, or alternatively, can be attached to a special heatsink structure designed into the PCB. This design optimizes the heat transfer from the integrated circuit (IC).

For information on the Quad Flatpack No-Lead (QFN) package and its advantages, refer to Application Report, QFN/SON PCB Attachment, Texas Instruments Literature No. SLUA271. This document is available at www.ti.com.

The exposed thermal pad dimensions for this package are shown in the following illustration.

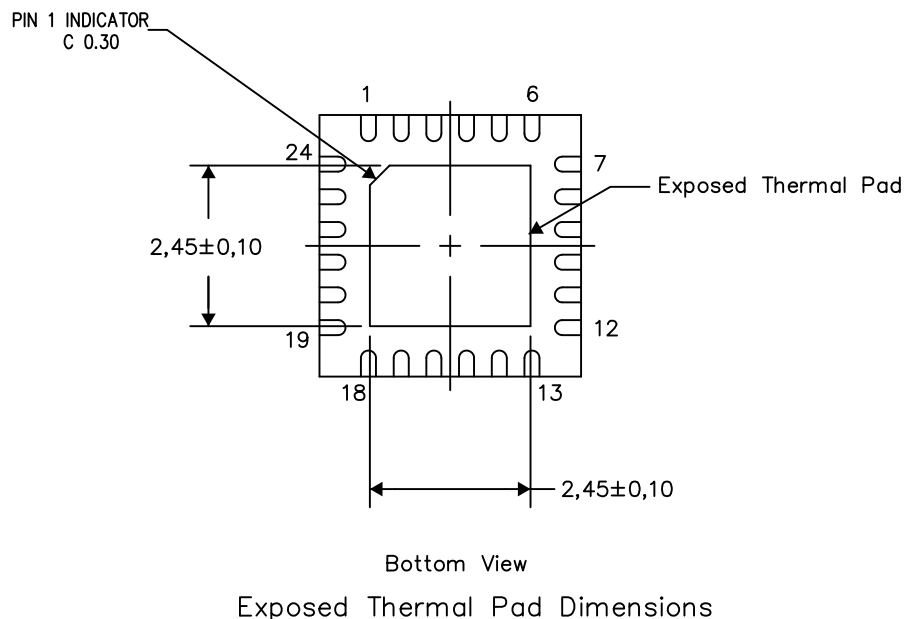

4206344-3/AC 03/13

NOTES: A. All linear dimensions are in millimeters

RGE (S-PVQFN-N24)

PLASTIC QUAD FLATPACK NO-LEAD

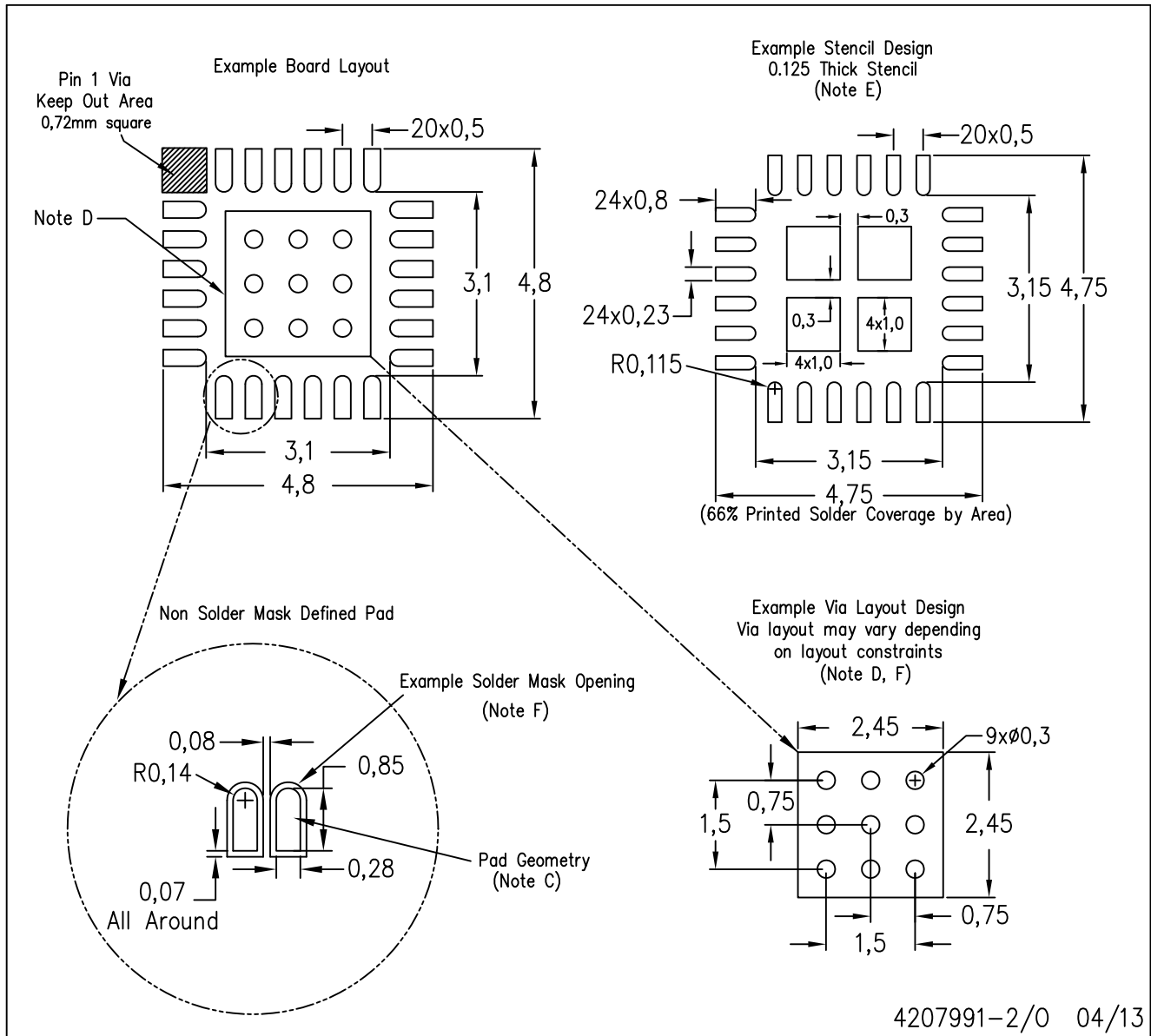

- NOTES:
- All linear dimensions are in millimeters.
 - This drawing is subject to change without notice.
 - Publication IPC-7351 is recommended for alternate designs.
 - This package is designed to be soldered to a thermal pad on the board. Refer to Application Note, Quad Flat-Pack Packages, Texas Instruments Literature No. SLUA271, and also the Product Data Sheets for specific thermal information, via requirements, and recommended board layout. These documents are available at www.ti.com <<http://www.ti.com>>.
 - Laser cutting apertures with trapezoidal walls and also rounding corners will offer better paste release. Customers should contact their board assembly site for stencil design recommendations. Refer to IPC 7525 for stencil design considerations.
 - Customers should contact their board fabrication site for recommended solder mask tolerances and via tenting recommendations for vias placed in the thermal pad.

IMPORTANT NOTICE

Texas Instruments Incorporated and its subsidiaries (TI) reserve the right to make corrections, enhancements, improvements and other changes to its semiconductor products and services per JESD46, latest issue, and to discontinue any product or service per JESD48, latest issue. Buyers should obtain the latest relevant information before placing orders and should verify that such information is current and complete. All semiconductor products (also referred to herein as "components") are sold subject to TI's terms and conditions of sale supplied at the time of order acknowledgment.

TI warrants performance of its components to the specifications applicable at the time of sale, in accordance with the warranty in TI's terms and conditions of sale of semiconductor products. Testing and other quality control techniques are used to the extent TI deems necessary to support this warranty. Except where mandated by applicable law, testing of all parameters of each component is not necessarily performed.

TI assumes no liability for applications assistance or the design of Buyers' products. Buyers are responsible for their products and applications using TI components. To minimize the risks associated with Buyers' products and applications, Buyers should provide adequate design and operating safeguards.

TI does not warrant or represent that any license, either express or implied, is granted under any patent right, copyright, mask work right, or other intellectual property right relating to any combination, machine, or process in which TI components or services are used. Information published by TI regarding third-party products or services does not constitute a license to use such products or services or a warranty or endorsement thereof. Use of such information may require a license from a third party under the patents or other intellectual property of the third party, or a license from TI under the patents or other intellectual property of TI.

Reproduction of significant portions of TI information in TI data books or data sheets is permissible only if reproduction is without alteration and is accompanied by all associated warranties, conditions, limitations, and notices. TI is not responsible or liable for such altered documentation. Information of third parties may be subject to additional restrictions.

Resale of TI components or services with statements different from or beyond the parameters stated by TI for that component or service voids all express and any implied warranties for the associated TI component or service and is an unfair and deceptive business practice. TI is not responsible or liable for any such statements.

Buyer acknowledges and agrees that it is solely responsible for compliance with all legal, regulatory and safety-related requirements concerning its products, and any use of TI components in its applications, notwithstanding any applications-related information or support that may be provided by TI. Buyer represents and agrees that it has all the necessary expertise to create and implement safeguards which anticipate dangerous consequences of failures, monitor failures and their consequences, lessen the likelihood of failures that might cause harm and take appropriate remedial actions. Buyer will fully indemnify TI and its representatives against any damages arising out of the use of any TI components in safety-critical applications.

In some cases, TI components may be promoted specifically to facilitate safety-related applications. With such components, TI's goal is to help enable customers to design and create their own end-product solutions that meet applicable functional safety standards and requirements. Nonetheless, such components are subject to these terms.

No TI components are authorized for use in FDA Class III (or similar life-critical medical equipment) unless authorized officers of the parties have executed a special agreement specifically governing such use.

Only those TI components which TI has specifically designated as military grade or "enhanced plastic" are designed and intended for use in military/aerospace applications or environments. Buyer acknowledges and agrees that any military or aerospace use of TI components which have **not** been so designated is solely at the Buyer's risk, and that Buyer is solely responsible for compliance with all legal and regulatory requirements in connection with such use.

TI has specifically designated certain components as meeting ISO/TS16949 requirements, mainly for automotive use. In any case of use of non-designated products, TI will not be responsible for any failure to meet ISO/TS16949.

Products

Audio	www.ti.com/audio
Amplifiers	amplifier.ti.com
Data Converters	dataconverter.ti.com
DLP® Products	www.dlp.com
DSP	dsp.ti.com
Clocks and Timers	www.ti.com/clocks
Interface	interface.ti.com
Logic	logic.ti.com
Power Mgmt	power.ti.com
Microcontrollers	microcontroller.ti.com
RFID	www.ti-rfid.com
OMAP Applications Processors	www.ti.com/omap
Wireless Connectivity	www.ti.com/wirelessconnectivity

Applications

Automotive and Transportation	www.ti.com/automotive
Communications and Telecom	www.ti.com/communications
Computers and Peripherals	www.ti.com/computers
Consumer Electronics	www.ti.com/consumer-apps
Energy and Lighting	www.ti.com/energy
Industrial	www.ti.com/industrial
Medical	www.ti.com/medical
Security	www.ti.com/security
Space, Avionics and Defense	www.ti.com/space-avionics-defense
Video and Imaging	www.ti.com/video

TI E2E Community

e2e.ti.com