

System-Side Impedance Track™ Fuel Gauge With Integrated LDO

Check for Samples: [bq27520-G4](#)

FEATURES

- **Single series cell Li-Ion battery fuel gauge resides on system board**
 - **Integrated 2.5 VDC LDO**
 - **External low-value 10 mΩ sense resistor**
- **Patented Impedance Track™ technology**
 - **Adjusts for battery aging, self-discharge, temperature, and rate changes**
 - **Reports Remaining Capacity, State of Charge (SOC), and Time-to-Empty**
 - **Optional Smoothing Filter**
 - **Battery State of Health (aging) estimation**
 - **Supports embedded or removable packs with up to 32Ahr capacity**
 - **Accommodates pack swapping with 2 separate battery profiles**
- **Microcontroller peripheral supports:**
 - **400-kHz I²C™ serial interface**
 - **32 Bytes of Scratch-Pad FLASH NVM**
 - **Battery Low digital output warning**
 - **Configurable SOC Interrupts**
 - **External thermistor, internal sensor, or host reported temperature options**
- **Tiny 15-pin 2610 × 1956 μm, 0.5 mm pitch NanoFree™ (CSP) package**

APPLICATIONS

- **Smartphones, Feature phones and Tablets**
- **Digital Still and Video Cameras**
- **Handheld Terminals**
- **MP3 or Multimedia Players**

DESCRIPTION

The Texas Instruments bq27520-G4 system-side Li-Ion battery fuel gauge is a microcontroller peripheral that provides fuel gauging for single-cell Li-Ion battery packs. The device requires little system microcontroller firmware development. The bq27520-G4 resides on the system's main board and manages an embedded battery (non-removable) or a removable battery pack.

The bq27520-G4 uses the patented Impedance Track™ algorithm for fuel gauging, and provides information such as remaining battery capacity (mAh), state-of-charge (%), run-time to empty (min), battery voltage (mV), temperature (°C) and state of health (%).

Battery fuel gauging with the bq27520-G4 requires only PACK+ (P+), PACK- (P-), and optional Thermistor (T) connections to a removable battery pack or embedded battery circuit. The device uses a 15-ball NanoFree™ (CSP) package in the nominal dimensions of 2610 × 1956 μm with 0,5 mm lead pitch. It is ideal for space constrained applications.

TYPICAL APPLICATION

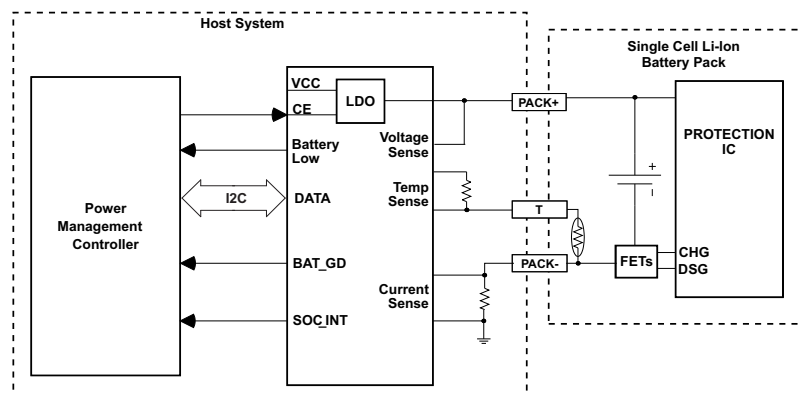

Please be aware that an important notice concerning availability, standard warranty, and use in critical applications of Texas Instruments semiconductor products and disclaimers thereto appears at the end of this data sheet.

Impedance Track, NanoFree are trademarks of Texas Instruments.
is a trademark of ~NXP B.V. Corp Netherlands.



These devices have limited built-in ESD protection. The leads should be shorted together or the device placed in conductive foam during storage or handling to prevent electrostatic damage to the MOS gates.

DEVICE INFORMATION

AVAILABLE OPTIONS

PART NUMBER	FIRMWARE VERSION ⁽¹⁾	PACKAGE ⁽²⁾	T _A	COMMUNICATION FORMAT	TAPE and REEL QUANTITY
bq27520YZFR-G4	3.29 (0x0329)	CSP-15	–40°C to 85°C	I ² C	3000
bq27520YZFT-G4					250

- (1) Refer to the *FW_VERSION* subcommand to confirm the firmware version.
 (2) For the most current package and ordering information, see the Package Option Addendum at the end of this document, or see the TI website at www.ti.com.

THERMAL INFORMATION

THERMAL METRIC ⁽¹⁾		bq27520-G4	UNITS
		YZF(15 PINS)	
θ_{JA}	Junction-to-ambient thermal resistance	70	°C/W
θ_{JCTop}	Junction-to-case (top) thermal resistance	17	
θ_{JB}	Junction-to-board thermal resistance	20	
Ψ_{JT}	Junction-to-top characterization parameter	1	
Ψ_{JB}	Junction-to-board characterization parameter	18	
θ_{JCbott}	Junction-to-case (bottom) thermal resistance	n/a	

- (1) For more information about traditional and new thermal metrics, see the IC Package Thermal Metrics application report, [SPRA953](#)

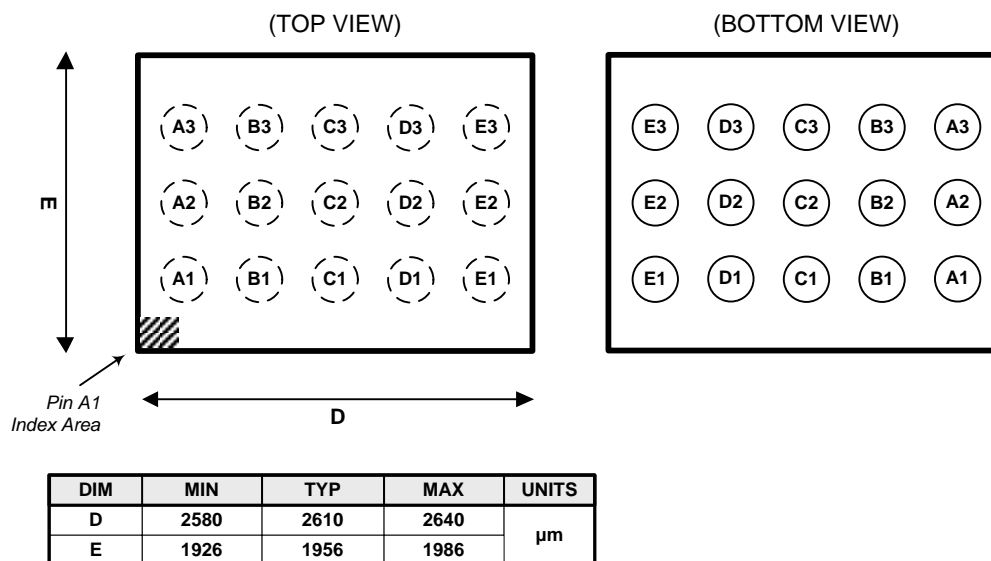
PIN ASSIGNMENT AND PACKAGE DIMENSIONS

Table 1. PIN FUNCTIONS

PIN		TYPE ⁽¹⁾	DESCRIPTION
NAME	NO.		
SRP	A1	IA	Analog input pin connected to the internal coulomb counter with a Kelvin connection where SRP is nearest the PACK– connection. Connect to 5-mΩ to 20-mΩ sense resistor.
SRN	B1	IA	Analog input pin connected to the internal coulomb counter with a Kelvin connection where SRN is nearest the V _{SS} connection. Connect to 5-mΩ to 20-mΩ sense resistor.
V _{SS}	C1, C2	P	Device ground
V _{CC}	D1	P	Regulator output and bq27520-G4 processor power. Decouple with 1μF ceramic capacitor to V _{SS} .
REGIN	E1	P	Regulator input. Decouple with 0.1μF ceramic capacitor to V _{SS} .
SOC_INT	A2	O	SOC state interrupts output. Generates a pulse under the conditions specified by ⁽¹⁾ . Open drain output.
BAT_GD	B2	O	Battery Good push-pull indicator output. Active-low and output disabled by default. Polarity is configured via Op Config [BATG_POL] and the output is enabled via OpConfig C [BATGSPUEN] .
CE	D2	I	Chip Enable. Internal LDO is disconnected from REGIN when driven low. Note: CE has an internal ESD protection diode connected to REGIN. Recommend maintaining V _{CE} ≤ V _{REGIN} under all conditions.
BAT	E2	I	Cell-voltage measurement input. ADC input. Recommend 4.8V maximum for conversion accuracy.
SCL	A3	I	Slave I ² C serial communications clock input line for communication with system (Master). Open-drain I/O. Use with 10kΩ pull-up resistor (typical).
SDA	B3	I/O	Slave I ² C serial communications data line for communication with system (Master). Open-drain I/O. Use with 10kΩ pull-up resistor (typical).
BAT_LOW	C3	O	Battery Low push-pull output indicator. Active high and output enabled by default. Polarity is configured via Op Config [BATL_POL] and the output is enabled via OpConfig C [BATLSPUEN] .
TS	D3	IA	Pack thermistor voltage sense (use 103AT-type thermistor). ADC input.
BI/TOUT	E3	I/O	Battery-insertion detection input. Power pin for pack thermistor network. Thermistor-multiplexer control pin. Use with pull-up resistor >1MΩ (1.8 MΩ typical).

(1) I/O = Digital input/output, IA = Analog input, P = Power connection

ELECTRICAL SPECIFICATIONS

ABSOLUTE MAXIMUM RATINGS

 over operating free-air temperature range (unless otherwise noted)⁽¹⁾

PARAMETER		VALUE	UNIT
V _{REGIN}	Regulator input range	-0.3 to 5.5	V
		-0.3 to 6.0 ⁽²⁾	V
V _{CE}	CE input pin	-0.3 to V _{REGIN} + 0.3	V
V _{CC}	Supply voltage range	-0.3 to 2.75	V
V _{IOD}	Open-drain I/O pins (SDA, SCL, SOC_INT)	-0.3 to 5.5	V
V _{BAT}	BAT input pin	-0.3 to 5.5	V
		-0.3 to 6.0 ⁽²⁾	V
V _I	Input voltage range to all other pins (BI/TOUT , TS , SRP, SRN, BAT_GD)	-0.3 to V _{CC} + 0.3	V
ESD	Human-body model (HBM), BAT pin	1.5	kV
	Human-body model (HBM), all other pins	2	
T _A	Operating free-air temperature range	-40 to 85	°C
T _{stg}	Storage temperature range	-65 to 150	°C

- (1) Stresses beyond those listed under "absolute maximum ratings" may cause permanent damage to the device. These are stress ratings only, and functional operation of the device at these or any other conditions beyond those indicated under "recommended operating conditions" is not implied. Exposure to absolute-maximum-rated conditions for extended periods may affect device reliability.
- (2) Condition not to exceed 100 hours at 25 °C lifetime.

RECOMMENDED OPERATING CONDITIONS

 T_A = -40°C to 85°C, V_{REGIN} = V_{BAT} = 3.6V (unless otherwise noted)

PARAMETER	TEST CONDITIONS	MIN	TYP	MAX	UNIT
V _{REGIN}	Supply voltage				V
	No operating restrictions	2.8		4.5	
	No FLASH writes	2.45		2.8	
C _{REGIN}	External input capacitor for internal LDO between REGIN and V _{SS}		0.1		μF
C _{LDO25}	External output capacitor for internal LDO between V _{CC} and V _{SS}	0.47	1		μF
t _{PUCD}	Power-up communication delay		250		ms

SUPPLY CURRENT

 T_A = 25°C and V_{REGIN} = V_{BAT} = 3.6V (unless otherwise noted)

PARAMETER	TEST CONDITIONS	MIN	TYP	MAX	UNIT
I _{CC} ⁽¹⁾	Normal operating-mode current Fuel gauge in NORMAL mode. I _{LOAD} > Sleep Current		118		μA
I _{SLEEP+} ⁽¹⁾	Sleep+ operating mode current Fuel gauge in SLEEP+ mode. I _{LOAD} < Sleep Current		62		μA
I _{SLEEP} ⁽¹⁾	Low-power storage-mode current Fuel gauge in SLEEP mode. I _{LOAD} < Sleep Current		23		μA
I _{HIB} ⁽¹⁾	Hibernate operating-mode current Fuel gauge in HIBERNATE mode. I _{LOAD} < Hibernate Current		8		μA

- (1) Specified by design. Not production tested.

DIGITAL INPUT AND OUTPUT DC CHARACTERISTICS

$T_A = -40^{\circ}\text{C}$ to 85°C , typical values at $T_A = 25^{\circ}\text{C}$ and $V_{\text{REGIN}} = 3.6\text{ V}$ (unless otherwise noted)

PARAMETER	TEST CONDITIONS	MIN	TYP	MAX	UNIT
V_{OL}	Output voltage, low (SCL, SDA, SOC_INT, BAT_LOW, BAT_GD) $I_{\text{OL}} = 3\text{ mA}$			0.4	V
$V_{\text{OH(PP)}}$	Output voltage, high (BAT_LOW, BAT_GD) $I_{\text{OH}} = -1\text{ mA}$	$V_{\text{CC}} - 0.5$			V
$V_{\text{OH(OD)}}$	Output voltage, high (SDA, SCL, SOC_INT) External pullup resistor connected to V_{CC}	$V_{\text{CC}} - 0.5$			
V_{IL}	Input voltage, low (SDA, SCL)	-0.3		0.6	V
	Input voltage, low (BI/TOUT)	BAT INSERT CHECK MODE active	-0.3	0.6	
V_{IH}	Input voltage, high (SDA, SCL)	1.2			V
	Input voltage, high (BI/TOUT)	BAT INSERT CHECK MODE active	1.2	$V_{\text{CC}} + 0.3$	
$V_{\text{IL(CE)}}$	Input voltage, low (CE)			0.8	V
$V_{\text{IH(CE)}}$	Input voltage, high (CE)	$V_{\text{REGIN}} = 2.8$ to 4.5 V	2.65		
$I_{\text{IKg}}^{(1)}$	Input leakage current (I/O pins)			0.3	μA

(1) Specified by design. Not production tested.

POWER-ON RESET

$T_A = -40^{\circ}\text{C}$ to 85°C , typical values at $T_A = 25^{\circ}\text{C}$ and $V_{\text{REGIN}} = 3.6\text{ V}$ (unless otherwise noted)

PARAMETER	TEST CONDITIONS	MIN	TYP	MAX	UNIT
$V_{\text{IT+}}$	Positive-going battery voltage input at V_{CC}	2.05	2.15	2.20	V
V_{HYS}	Power-on reset hysteresis	45	115	185	mV

2.5V LDO REGULATOR

$T_A = -40^{\circ}\text{C}$ to 85°C , $C_{\text{LDO25}} = 1\mu\text{F}$, $V_{\text{REGIN}} = 3.6\text{ V}$ (unless otherwise noted)

PARAMETER	TEST CONDITION	MIN	NOM	MAX	UNIT
V_{REG25}	Regulator output voltage (V_{CC}) $2.8\text{ V} \leq V_{\text{REGIN}} \leq 4.5\text{ V}$, $I_{\text{OUT}} \leq 16\text{ mA}$	2.3	2.5	2.6	V
	$2.45\text{ V} \leq V_{\text{REGIN}} < 2.8\text{ V}$ (low battery), $I_{\text{OUT}} \leq 3\text{ mA}$	2.3			V

INTERNAL CLOCK OSCILLATORS

$T_A = -40^{\circ}\text{C}$ to 85°C , $2.4\text{ V} < V_{\text{CC}} < 2.6\text{ V}$; typical values at $T_A = 25^{\circ}\text{C}$ and $V_{\text{CC}} = 2.5\text{ V}$ (unless otherwise noted)

PARAMETER	TEST CONDITIONS	MIN	TYP	MAX	UNIT
f_{OSC}	High Frequency Oscillator		2.097		MHz
f_{LOSC}	Low Frequency Oscillator		32.768		kHz

ADC (TEMPERATURE AND CELL MEASUREMENT) CHARACTERISTICS

 $T_A = -40^{\circ}\text{C}$ to 85°C , $2.4\text{ V} < V_{CC} < 2.6\text{ V}$; typical values at $T_A = 25^{\circ}\text{C}$ and $V_{CC} = 2.5\text{ V}$ (unless otherwise noted)

PARAMETER	TEST CONDITIONS	MIN	TYP	MAX	UNIT
V_{A1}	Input voltage range (TS)	$V_{SS} - 0.125$		2	V
V_{A2}	Input voltage range (BAT)	$V_{SS} - 0.125$		5	V
$V_{IN(ADC)}$	Input voltage range	0.05		1	V
G_{TEMP}	Internal temperature sensor voltage gain		-2		mV/°C
t_{ADC_CONV}	Conversion time			125	ms
	Resolution	14		15	bits
$V_{OS(ADC)}$	Input offset		1		mV
$Z_{ADC1}^{(1)}$	Effective input resistance (TS)	8			MΩ
$Z_{ADC2}^{(1)}$	Effective input resistance (BAT)	bq27520-G4 not measuring cell voltage			MΩ
		bq27520-G4 measuring cell voltage		100	kΩ
$I_{lkq(ADC)}^{(1)}$	Input leakage current			0.3	μA

(1) Specified by design. Not tested in production.

INTEGRATING ADC (COULOMB COUNTER) CHARACTERISTICS

 $T_A = -40^{\circ}\text{C}$ to 85°C , $2.4\text{ V} < V_{CC} < 2.6\text{ V}$; typical values at $T_A = 25^{\circ}\text{C}$ and $V_{CC} = 2.5\text{ V}$ (unless otherwise noted)

PARAMETER	TEST CONDITIONS	MIN	TYP	MAX	UNIT	
V_{SR}	Input voltage range, $V_{(SRN)}$ and $V_{(SRP)}$	$V_{SR} = V_{(SRN)} - V_{(SRP)}$		-0.125	0.125	V
t_{SR_CONV}	Conversion time	Single conversion				
	Resolution	14	1	15	s	
$V_{OS(SR)}$	Input offset		10		μV	
INL	Integral nonlinearity error		±0.007	±0.034	% FSR	
$Z_{IN(SR)}^{(1)}$	Effective input resistance	2.5			MΩ	
$I_{lkq(SR)}^{(1)}$	Input leakage current			0.3	μA	

(1) Specified by design. Not tested in production.

DATA FLASH MEMORY CHARACTERISTICS

$T_A = -40^{\circ}\text{C}$ to 85°C , $2.4\text{ V} < V_{CC} < 2.6\text{ V}$; typical values at $T_A = 25^{\circ}\text{C}$ and $V_{CC} = 2.5\text{ V}$ (unless otherwise noted)

PARAMETER	TEST CONDITIONS	MIN	TYP	MAX	UNIT
$t_{DR}^{(1)}$	Data retention	10			Years
	Flash-programming write cycles ⁽¹⁾	20,000			Cycles
$t_{WORDPROG}^{(1)}$	Word programming time			2	ms
$I_{CCPROG}^{(1)}$	Flash-write supply current		5	10	mA
$t_{DFERASE}^{(1)}$	Data flash master erase time	200			ms
$t_{IFERASE}^{(1)}$	Instruction flash master erase time	200			ms
$t_{PGERASE}^{(1)}$	Flash page erase time	20			ms

(1) Specified by design. Not production tested

I²C-COMPATIBLE INTERFACE COMMUNICATION TIMING CHARACTERISTICS

$T_A = -40^{\circ}\text{C}$ to 85°C , $2.4\text{ V} < V_{CC} < 2.6\text{ V}$; typical values at $T_A = 25^{\circ}\text{C}$ and $V_{CC} = 2.5\text{ V}$ (unless otherwise noted)

PARAMETER	TEST CONDITIONS	MIN	TYP	MAX	UNIT
t_r	SCL/SDA rise time			300	ns
t_f	SCL/SDA fall time			300	ns
$t_{w(H)}$	SCL pulse duration (high)	600			ns
$t_{w(L)}$	SCL pulse duration (low)	1.3			μs
$t_{su(STA)}$	Setup for repeated start	600			ns
$t_{d(STA)}$	Start to first falling edge of SCL	600			ns
$t_{su(DAT)}$	Data setup time	100			ns
$t_{h(DAT)}$	Data hold time	0			ns
$t_{su(STOP)}$	Setup time for stop	600			ns
$t_{(BUF)}$	Bus free time between stop and start	66			μs
f_{SCL}	Clock frequency ⁽¹⁾			400	kHz

(1) If the clock frequency (f_{SCL}) is $> 100\text{ kHz}$, use 1-byte write commands for proper operation. All other transactions types are supported at 400 kHz. (Refer to [I²C INTERFACE](#) and [I²C Command Waiting Time](#))

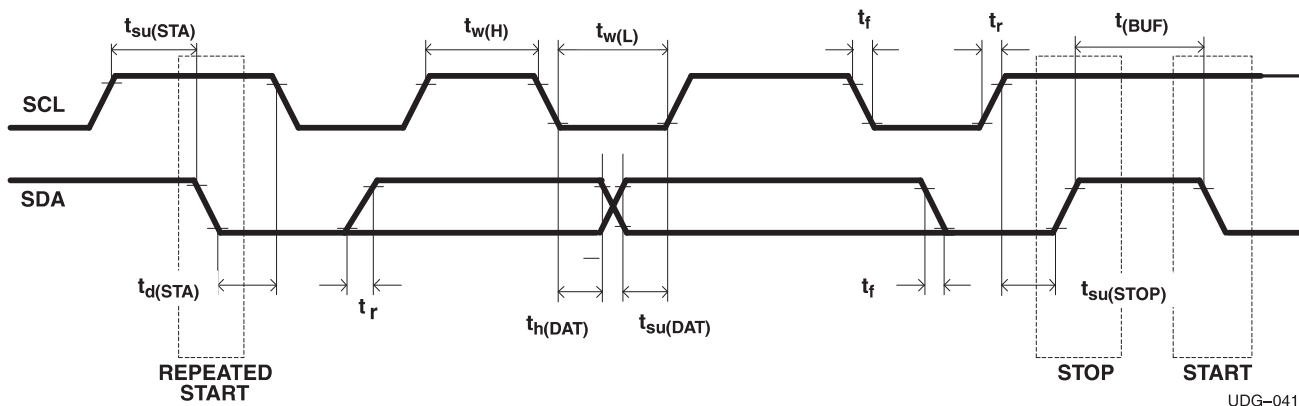

Figure 1. I²C-Compatible Interface Timing Diagrams

GENERAL DESCRIPTION

The bq27520-G4 accurately predicts the battery capacity and other operational characteristics of a single Li-based rechargeable cell. It can be interrogated by a system processor to provide cell information, such as time-to-empty (TTE) and state-of-charge (SOC) as well as SOC interrupt signal to the host.

Information is accessed through a series of commands, called *Standard Commands*. Further capabilities are provided by the additional *Extended Commands* set. Both sets of commands, indicated by the general format *Command()*, are used to read and write information contained within the device control and status registers, as well as its data flash locations. Commands are sent from system to gauge using the bq27520-G4's I²C serial communications engine, and can be executed during application development, system manufacture, or end-equipment operation.

Cell information is stored in the device in non-volatile flash memory. Many of these data flash locations are accessible during application development. They cannot, generally, be accessed directly during end-equipment operation. Access to these locations is achieved by either use of the bq27520-G4's companion evaluation software, through individual commands, or through a sequence of data-flash-access commands. To access a desired data flash location, the correct data flash subclass and offset must be known.

The key to the bq27520-G4's high-accuracy gas gauging prediction is Texas Instrument's proprietary Impedance Track™ algorithm. This algorithm uses cell measurements, characteristics, and properties to create state-of-charge predictions that can achieve less than 1% error across a wide variety of operating conditions and over the lifetime of the battery.

The device measures charge/discharge activity by monitoring the voltage across a small-value series sense resistor (5 mΩ to 20 mΩ typ.) located between the system's Vss and the battery's PACK- terminal. When a cell is attached to the device, cell impedance is learned, based on cell current, cell open-circuit voltage (OCV), and cell voltage under loading conditions.

The device external temperature sensing is optimized with the use of a high accuracy negative temperature coefficient (NTC) thermistor with R25 = 10.0kΩ ±1%. B25/85 = 3435K ± 1% (such as Semitec NTC 103AT). Alternatively, the bq27520-G4 can also be configured to use its internal temperature sensor or receive temperature data from the host processor. When an external thermistor is used, a 18.2k pull up resistor between BI/TOUT and TS pins is also required. The bq27520-G4 uses temperature to monitor the battery-pack environment, which is used for fuel gauging and cell protection functionality.

To minimize power consumption, the device has different power modes: NORMAL, SLEEP+, SLEEP, HIBERNATE, and BAT INSERT CHECK. The bq27520-G4 passes automatically between these modes, depending upon the occurrence of specific events, though a system processor can initiate some of these modes directly.

For complete operational details, refer to [bq27520-G4 Technical Reference Manual](#).

NOTE

FORMATTING CONVENTIONS IN THIS DOCUMENT:

Commands: *italics* with *parentheses* and no breaking spaces, e.g. *RemainingCapacity()*.

NVM Data: *italics*, **bold**, and *breaking spaces*, e.g. **Design Capacity**.

Register bits and flags: *brackets* and *italics*, e.g. *[TDA]*

NVM Data bits: *brackets*, *italics* and **bold**, e.g. **[LED1]**

Modes and states: ALL CAPITALS, e.g. UNSEALED mode.

DATA COMMANDS

STANDARD DATA COMMANDS

The bq27520-G4 uses a series of 2-byte standard commands to enable system reading and writing of battery information. Each standard command has an associated command-code pair, as indicated in [Table 2](#). Because each command consists of two bytes of data, two consecutive I²C transmissions must be executed both to initiate the command function, and to read or write the corresponding two bytes of data. Additional details are found in the [bq27520-G4 Technical Reference Manual](#).

Table 2. Standard Commands

NAME		COMMAND CODE	UNITS	SEALED ACCESS
<i>Control()</i>	CNTL	0x00 / 0x01	N/A	R/W
<i>AtRate()</i>		0x02 / 0x03	mA	R/W
<i>AtRateTimeToEmpty()</i>		0x04 / 0x05	Minutes	R
<i>Temperature()</i>	TEMP	0x06 / 0x07	0.1 K	R/W
<i>Voltage()</i>	VOLT	0x08 / 0x09	mV	R
<i>Flags()</i>	FLAGS	0x0a / 0x0b	N/A	R
<i>NominalAvailableCapacity()</i>	NAC	0x0c / 0x0d	mAh	R
<i>FullAvailableCapacity()</i>	FAC	0x0e / 0x0f	mAh	R
<i>RemainingCapacity()</i>	RM	0x10 / 0x11	mAh	R
<i>FullChargeCapacity()</i>	FCC	0x12 / 0x13	mAh	R
<i>AverageCurrent()</i>		0x14 / 0x15	mA	R
<i>TimeToEmpty()</i>	TTE	0x16 / 0x17	Minutes	R
<i>StandbyCurrent()</i>		0x18 / 0x19	mA	R
<i>StandbyTimeToEmpty()</i>		0x1a / 0x1b	Minutes	R
<i>StateOfHealth()</i>	SOH	0x1c / 0x1d	% / num	R
<i>CycleCount()</i>		0x1e / 0x1f	num	R
<i>StateOfCharge()</i>	SOC	0x20 / 0x21	%	R
<i>InstantaneousCurrent()</i>		0x22 / 0x23	mA	R
<i>InternalTemperature()</i>		0x28 / 0x29	0.1 K	R
<i>ResistanceScale()</i>		0x2a / 0x2b		R
<i>OperationConfiguration()</i>	Op Config	0x2c / 0x2d	N/A	R
<i>DesignCapacity()</i>		0x2e / 0x2f	mAh	R

Control(): 0x00/0x01

Issuing a *Control()* command requires a subsequent 2-byte subcommand. These additional bytes specify the particular control function desired. The *Control()* command allows the system to control specific features of the bq27520-G4 during normal operation and additional features when the device is in different access modes, as described in [Table 3](#). Additional details are found in the [bq27520-G4 Technical Reference Manual](#).

Table 3. Control() Subcommands

CNTL FUNCTION	CNTL DATA	SEALED ACCESS	DESCRIPTION
CONTROL_STATUS	0x0000	Yes	Reports the status of DF checksum, hibernate, IT, etc.
DEVICE_TYPE	0x0001	Yes	Reports the device type (eg: 0x0520)
FW_VERSION	0x0002	Yes	Reports the firmware version on the device type
PREV_MACWRITE	0x0007	Yes	Returns previous <i>Control()</i> subcommand code
CHEM_ID	0x0008	Yes	Reports the chemical identifier of the Impedance Track™ configuration
OCV_CMD	0x000c	Yes	Request the gauge to take a OCV measurement
BAT_INSERT	0x000d	Yes	Forces <i>Flags() [BAT_DET]</i> bit set when OpConfig B [BIE] = 0
BAT_REMOVE	0x000e	Yes	Forces <i>Flags() [BAT_DET]</i> bit clear when OpConfig B [BIE] = 0
SET_HIBERNATE	0x0011	Yes	Forces <i>CONTROL_STATUS [HIBERNATE]</i> to 1
CLEAR_HIBERNATE	0x0012	Yes	Forces <i>CONTROL_STATUS [HIBERNATE]</i> to 0
SET_SLEEP+	0x0013	Yes	Forces <i>CONTROL_STATUS [SNOOZE]</i> to 1
CLEAR_SLEEP+	0x0014	Yes	Forces <i>CONTROL_STATUS [SNOOZE]</i> to 0
DF_VERSION	0x001F	Yes	Returns the Data Flash Version code
SEALED	0x0020	No	Places the bq27520-G4 in SEALED access mode
IT_ENABLE	0x0021	No	Enables the Impedance Track™ (IT) algorithm
RESET	0x0041	No	Forces a full reset of the bq27520-G4

FUNCTIONAL DESCRIPTION

The bq27520-G4 measures the voltage, temperature, and current to determine battery capacity and state of charge (SOC) based on the patented Impedance Track™ algorithm (Refer to Application Report [SLUA450, Theory and Implementation of Impedance Track Battery Fuel-Gauging Algorithm](#) for more information). The bq27520-G4 monitors charge and discharge activity by sensing the voltage across a small-value resistor (5 mΩ to 20 mΩ typ.) between the SRP and SRN pins and in series with the battery. By integrating charge passing through the battery, the battery's SOC is adjusted during battery charge or discharge.

Battery capacity is found by comparing states of charge before and after applying the load with the amount of charge passed. When a system load is applied, the impedance of the battery is measured by comparing the open circuit voltage (OCV) obtained from a predefined function for present SOC with the measured voltage under load. Measurements of OCV and charge integration determine chemical state of charge and chemical capacity (Qmax). The initial Qmax values are taken from a cell manufacturers' data sheet multiplied by the number of parallel cells. It is also used for the value in **Design Capacity**. The bq27520-G4 acquires and updates the battery-impedance profile during normal battery usage. It uses this profile, along with SOC and the Qmax value, to determine *FullChargeCapacity*() and *StateOfCharge*(), specifically for the present load and temperature. *FullChargeCapacity*() is reported as capacity available from a fully charged battery under the present load and temperature until *Voltage*() reaches the **Terminate Voltage**. *NominalAvailableCapacity*() and *FullAvailableCapacity*() are the uncompensated (no or light load) versions of *RemainingCapacity*() and *FullChargeCapacity*() respectively.

The bq27520-G4 has two *Flags*() bits and two pins to warn the host if the battery's SOC has fallen to critical levels. If *RemainingCapacity*() falls below the first capacity threshold specified by **SOC1 Set Threshold**, the *Flags*() [SOC1] bit is set and is cleared if *RemainingCapacity*() rises above the **SOC1 Clear Threshold**. If enabled via **OpConfig C [BATLSPUEN]**, the BAT_LOW pin reflects the status of the [SOC1] flag bit. Also, if enabled by **OpConfig B [BL_INT]**, the SOC_INT will toggle upon a state change of the [SOC1] flag bit.

As *Voltage*() falls below the **SysDown Set Volt Threshold**, the *Flags*() [SYSDOWN] bit is set and SOC_INT will toggle once to provide a final warning to shut down the system. As *Voltage*() rises above **SysDown Clear Voltage** the [SYSDOWN] bit is cleared and SOC_INT will toggle once to signal the status change.

Additional details are found in the [bq27520-G4 Technical Reference Manual](#).

COMMUNICATIONS

I²C INTERFACE

The bq27520-G4 supports the standard I²C read, incremental read, quick read, one byte write, and incremental write functions. The 7 bit device address (ADDR) is the most significant 7 bits of the hex address and is fixed as 1010101. The first 8-bits of the I²C protocol will; therefore, be 0xAA or 0xAB for write or read, respectively.

Host generated Gauge generated

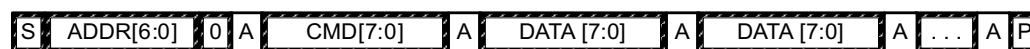
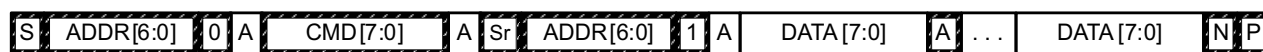
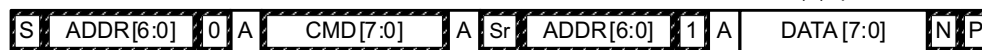

(S = Start, Sr = Repeated Start, A = Acknowledge, N = No Acknowledge, and P = Stop).

The “quick read” returns data at the address indicated by the address pointer. The address pointer, a register internal to the I²C communication engine, will increment whenever data is acknowledged by the bq27520-G4 or the I²C master. “Quick writes” function in the same manner and are a convenient means of sending multiple bytes to consecutive command locations (such as two-byte commands that require two bytes of data)

The following command sequences are not supported:

Attempt to write a read-only address (NACK after data sent by master):

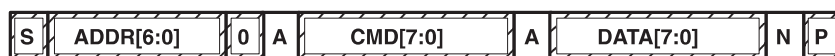

Attempt to read an address above 0x6B (NACK command):



I²C Time Out

The I²C engine will release both SDA and SCL if the I²C bus is held low for 2 seconds. If the bq27520-G4 was holding the lines, releasing them will free them for the master to drive the lines. If an external condition is holding either of the lines low, the I²C engine will enter the low power sleep mode.

I²C Command Waiting Time

To ensure proper operation at 400 kHz, a $t_{(BUF)} \geq 66 \mu s$ bus free waiting time should be inserted between all packets addressed to the bq27520-G4. In addition, if the SCL clock frequency (f_{SCL}) is > 100 kHz, use individual 1-byte write commands for proper data flow control. The following diagram shows the standard waiting time required between issuing the control subcommand the reading the status result. An OCV_CMD subcommand requires 1.2 seconds prior to reading the result. For read-write standard command, a minimum of 2 seconds is required to get the result updated. For read-only standard commands, there is no waiting time required, but the host should not issue all standard commands more than two times per second. Otherwise, the gauge could result in a reset issue due to the expiration of the watchdog timer.

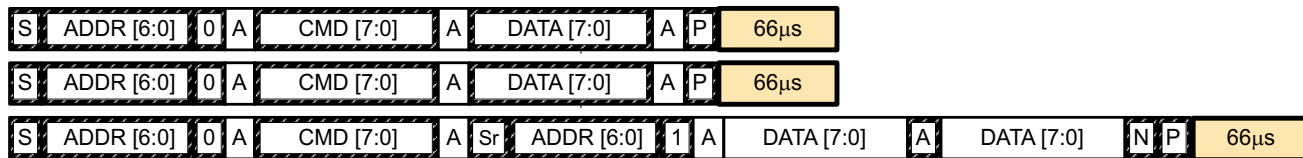

Waiting time inserted between two 1-byte write packets for a subcommand and reading results (required for $100 \text{ kHz} < f_{SCL} \leq 400 \text{ kHz}$)

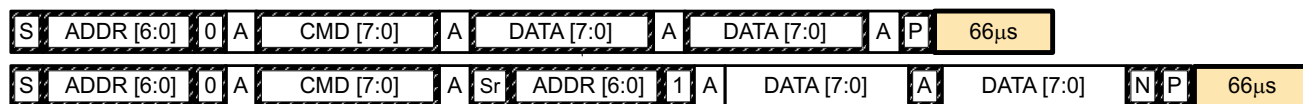

Waiting time inserted between incremental 2-byte write packet for a subcommand and reading results (acceptable for $f_{SCL} \leq 100 \text{ kHz}$)

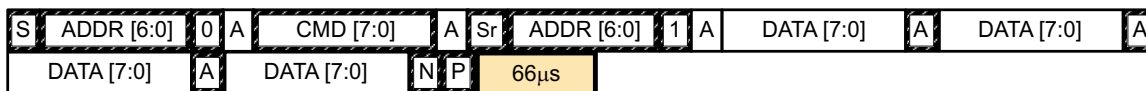

Waiting time inserted after incremental read

I²C Clock Stretching

A clock stretch can occur during all modes of fuel gauge operation. In SLEEP and HIBERNATE modes, a short clock stretch will occur on all I²C traffic as the device must wake-up to process the packet. In the other modes (BAT INSERT CHECK , NORMAL, SLEEP+) clock stretching will only occur for packets addressed for the fuel gauge. The majority of clock stretch periods are small as the I²C interface performs normal data flow control. However, less frequent yet more significant clock stretch periods may occur as blocks of Data Flash are updated. The following table summarizes the approximate clock stretch duration for various fuel gauge operating conditions.

Gauging Mode	Operating Condition / Comment	Approximate Duration
SLEEP HIBERNATE	Clock stretch occurs at the beginning of all traffic as the device wakes up.	$\leq 4 \text{ ms}$
BAT INSERT CHECK NORMAL SLEEP+	Clock stretch occurs within the packet for flow control. (after a start bit, ACK or first data bit)	$\leq 4 \text{ ms}$
	Normal Ra table Data Flash updates.	24 ms
	Data Flash block writes.	72 ms
	Restored Data Flash block write after loss of power.	116 ms
	End of discharge Ra table Data Flash update.	144 ms

PACKAGING INFORMATION

Orderable Device	Status (1)	Package Type	Package Drawing	Pins	Package Qty	Eco Plan (2)	Lead/Ball Finish	MSL Peak Temp (3)	Op Temp (°C)	Device Marking (4/5)	Samples
BQ27520YZFR-G4	ACTIVE	DSBGA	YZF	15	3000	Green (RoHS & no Sb/Br)	SNAGCU	Level-1-260C-UNLIM	-40 to 85	BQ27520	Samples
BQ27520YZFT-G4	ACTIVE	DSBGA	YZF	15	250	Green (RoHS & no Sb/Br)	SNAGCU	Level-1-260C-UNLIM	-40 to 85	BQ27520	Samples

(1) The marketing status values are defined as follows:

ACTIVE: Product device recommended for new designs.

LIFEBUY: TI has announced that the device will be discontinued, and a lifetime-buy period is in effect.

NRND: Not recommended for new designs. Device is in production to support existing customers, but TI does not recommend using this part in a new design.

PREVIEW: Device has been announced but is not in production. Samples may or may not be available.

OBSELETE: TI has discontinued the production of the device.

(2) Eco Plan - The planned eco-friendly classification: Pb-Free (RoHS), Pb-Free (RoHS Exempt), or Green (RoHS & no Sb/Br) - please check <http://www.ti.com/productcontent> for the latest availability information and additional product content details.

TBD: The Pb-Free/Green conversion plan has not been defined.

Pb-Free (RoHS): TI's terms "Lead-Free" or "Pb-Free" mean semiconductor products that are compatible with the current RoHS requirements for all 6 substances, including the requirement that lead not exceed 0.1% by weight in homogeneous materials. Where designed to be soldered at high temperatures, TI Pb-Free products are suitable for use in specified lead-free processes.

Pb-Free (RoHS Exempt): This component has a RoHS exemption for either 1) lead-based flip-chip solder bumps used between the die and package, or 2) lead-based die adhesive used between the die and leadframe. The component is otherwise considered Pb-Free (RoHS compatible) as defined above.

Green (RoHS & no Sb/Br): TI defines "Green" to mean Pb-Free (RoHS compatible), and free of Bromine (Br) and Antimony (Sb) based flame retardants (Br or Sb do not exceed 0.1% by weight in homogeneous material)

(3) MSL, Peak Temp. -- The Moisture Sensitivity Level rating according to the JEDEC industry standard classifications, and peak solder temperature.

(4) There may be additional marking, which relates to the logo, the lot trace code information, or the environmental category on the device.

(5) Multiple Device Markings will be inside parentheses. Only one Device Marking contained in parentheses and separated by a "~" will appear on a device. If a line is indented then it is a continuation of the previous line and the two combined represent the entire Device Marking for that device.

Important Information and Disclaimer:The information provided on this page represents TI's knowledge and belief as of the date that it is provided. TI bases its knowledge and belief on information provided by third parties, and makes no representation or warranty as to the accuracy of such information. Efforts are underway to better integrate information from third parties. TI has taken and continues to take reasonable steps to provide representative and accurate information but may not have conducted destructive testing or chemical analysis on incoming materials and chemicals. TI and TI suppliers consider certain information to be proprietary, and thus CAS numbers and other limited information may not be available for release.

In no event shall TI's liability arising out of such information exceed the total purchase price of the TI part(s) at issue in this document sold by TI to Customer on an annual basis.

TAPE AND REEL INFORMATION



QUADRANT ASSIGNMENTS FOR PIN 1 ORIENTATION IN TAPE



*All dimensions are nominal

Device	Package Type	Package Drawing	Pins	SPQ	Reel Diameter (mm)	Reel Width W1 (mm)	A0 (mm)	B0 (mm)	K0 (mm)	P1 (mm)	W (mm)	Pin1 Quadrant
BQ27520YZFT-G4	DSBGA	YZF	15	250	180.0	8.4	2.1	2.76	0.81	4.0	8.0	Q1

TAPE AND REEL BOX DIMENSIONS



*All dimensions are nominal

Device	Package Type	Package Drawing	Pins	SPQ	Length (mm)	Width (mm)	Height (mm)
BQ27520YZFT-G4	DSBGA	YZF	15	250	210.0	185.0	35.0

YZF (R-XBGA-N15)

DIE-SIZE BALL GRID ARRAY

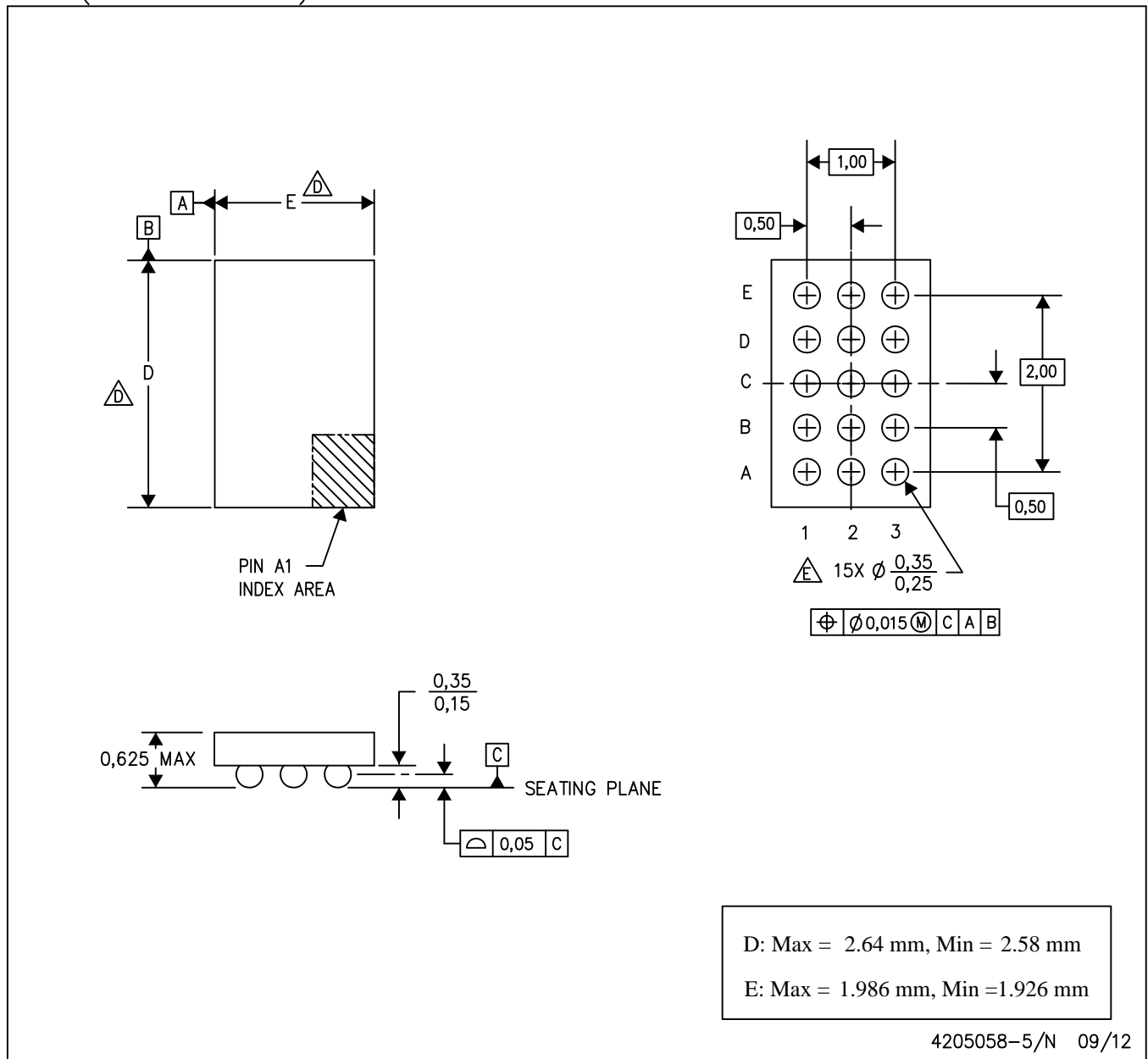

- NOTES:
- A. All linear dimensions are in millimeters. Dimensioning and tolerancing per ASME Y14.5M-1994.
 - B. This drawing is subject to change without notice.
 - C. NanoFree™ package configuration.
 - \triangle The package size (Dimension D and E) of a particular device is specified in the device Product Data Sheet version of this drawing, in case it cannot be found in the product data sheet please contact a local TI representative.
 - \triangle Reference Product Data Sheet for array population.
3 x 5 matrix pattern is shown for illustration only.
 - F. This package contains Pb-free balls.

NanoFree is a trademark of Texas Instruments.

IMPORTANT NOTICE

Texas Instruments Incorporated and its subsidiaries (TI) reserve the right to make corrections, enhancements, improvements and other changes to its semiconductor products and services per JESD46, latest issue, and to discontinue any product or service per JESD48, latest issue. Buyers should obtain the latest relevant information before placing orders and should verify that such information is current and complete. All semiconductor products (also referred to herein as "components") are sold subject to TI's terms and conditions of sale supplied at the time of order acknowledgment.

TI warrants performance of its components to the specifications applicable at the time of sale, in accordance with the warranty in TI's terms and conditions of sale of semiconductor products. Testing and other quality control techniques are used to the extent TI deems necessary to support this warranty. Except where mandated by applicable law, testing of all parameters of each component is not necessarily performed.

TI assumes no liability for applications assistance or the design of Buyers' products. Buyers are responsible for their products and applications using TI components. To minimize the risks associated with Buyers' products and applications, Buyers should provide adequate design and operating safeguards.

TI does not warrant or represent that any license, either express or implied, is granted under any patent right, copyright, mask work right, or other intellectual property right relating to any combination, machine, or process in which TI components or services are used. Information published by TI regarding third-party products or services does not constitute a license to use such products or services or a warranty or endorsement thereof. Use of such information may require a license from a third party under the patents or other intellectual property of the third party, or a license from TI under the patents or other intellectual property of TI.

Reproduction of significant portions of TI information in TI data books or data sheets is permissible only if reproduction is without alteration and is accompanied by all associated warranties, conditions, limitations, and notices. TI is not responsible or liable for such altered documentation. Information of third parties may be subject to additional restrictions.

Resale of TI components or services with statements different from or beyond the parameters stated by TI for that component or service voids all express and any implied warranties for the associated TI component or service and is an unfair and deceptive business practice. TI is not responsible or liable for any such statements.

Buyer acknowledges and agrees that it is solely responsible for compliance with all legal, regulatory and safety-related requirements concerning its products, and any use of TI components in its applications, notwithstanding any applications-related information or support that may be provided by TI. Buyer represents and agrees that it has all the necessary expertise to create and implement safeguards which anticipate dangerous consequences of failures, monitor failures and their consequences, lessen the likelihood of failures that might cause harm and take appropriate remedial actions. Buyer will fully indemnify TI and its representatives against any damages arising out of the use of any TI components in safety-critical applications.

In some cases, TI components may be promoted specifically to facilitate safety-related applications. With such components, TI's goal is to help enable customers to design and create their own end-product solutions that meet applicable functional safety standards and requirements. Nonetheless, such components are subject to these terms.

No TI components are authorized for use in FDA Class III (or similar life-critical medical equipment) unless authorized officers of the parties have executed a special agreement specifically governing such use.

Only those TI components which TI has specifically designated as military grade or "enhanced plastic" are designed and intended for use in military/aerospace applications or environments. Buyer acknowledges and agrees that any military or aerospace use of TI components which have **not** been so designated is solely at the Buyer's risk, and that Buyer is solely responsible for compliance with all legal and regulatory requirements in connection with such use.

TI has specifically designated certain components as meeting ISO/TS16949 requirements, mainly for automotive use. In any case of use of non-designated products, TI will not be responsible for any failure to meet ISO/TS16949.

Products

Audio	www.ti.com/audio
Amplifiers	amplifier.ti.com
Data Converters	dataconverter.ti.com
DLP® Products	www.dlp.com
DSP	dsp.ti.com
Clocks and Timers	www.ti.com/clocks
Interface	interface.ti.com
Logic	logic.ti.com
Power Mgmt	power.ti.com
Microcontrollers	microcontroller.ti.com
RFID	www.ti-rfid.com
OMAP Applications Processors	www.ti.com/omap
Wireless Connectivity	www.ti.com/wirelessconnectivity

Applications

Automotive and Transportation	www.ti.com/automotive
Communications and Telecom	www.ti.com/communications
Computers and Peripherals	www.ti.com/computers
Consumer Electronics	www.ti.com/consumer-apps
Energy and Lighting	www.ti.com/energy
Industrial	www.ti.com/industrial
Medical	www.ti.com/medical
Security	www.ti.com/security
Space, Avionics and Defense	www.ti.com/space-avionics-defense
Video and Imaging	www.ti.com/video

TI E2E Community

e2e.ti.com