

LOW INPUT VOLTAGE, ULTRA-LOW r_{ON} LOAD SWITCHES

Check for Samples: [TPS22921](#), [TPS22922](#), [TPS22922B](#)

FEATURES

- **Input Voltage: 0.9 V to 3.6 V**
- **Ultra-Low ON Resistance (Typical Values)**
 - $r_{ON} = 14\text{ m}\Omega$ at $V_{IN} = 3.6\text{ V}$
 - $r_{ON} = 20\text{ m}\Omega$ at $V_{IN} = 2.5\text{ V}$
 - $r_{ON} = 33\text{ m}\Omega$ at $V_{IN} = 1.8\text{ V}$
 - $r_{ON} = 67\text{ m}\Omega$ at $V_{IN} = 1.2\text{ V}$
 - $r_{ON} = 116\text{ m}\Omega$ at $V_{IN} = 1.0\text{ V}$
- **2-A Maximum Continuous Switch Current**
- **Ultra-Low Quiescent Current:**
 - Typical 78 nA at 1.8 V
- **Ultra-Low Shutdown Current:**
 - Typical 35 nA at 1.8 V
- **Low Threshold Control Input Enable the use of 1.2 V, 1.8 V, 2.5 V, or 3.3 V Logic**
- **Controlled Slew Rate to Avoid Inrush Currents**
- **Typical Rise Times at $V_{IN} = 1.8\text{ V}$**
 - TPS22921 and TPS22922: 30 μs
 - TPS22922B: 200 μs
- **ESD Performance Tested Per JESD 22**
 - 3000-V Human-Body Model (A114-B, Class II)
 - 1000-V Charged-Device Model (C101)
- **Six Terminal Wafer-Chip-Scale Package (nominal dimensions shown - see addendum for details)**
 - 0.9 mm \times 1.4 mm, 0.5-mm Pitch, 0.5-mm Height (YZP)
 - 0.9 mm \times 1.4 mm, 0.5-mm Pitch, 0.625-mm Height (YZT)
 - 0.8 mm \times 1.2 mm, 0.4-mm Pitch, 0.5-mm Height (YFP)

APPLICATIONS

- PDAs
- Cell Phones
- GPS Devices
- MP3 Players
- Peripheral Ports
- Portable Media Players
- RF Modules

DESCRIPTION

TPS22921, TPS22922, and TPS22922B are ultra-low r_{ON} load switches with controlled turn on. TPS22921/2/2B contain an ultra-low r_{ON} P-channel MOSFET that can operate over an input voltage range of 0.9 V to 3.6 V. The switch is controlled by an on/off input (ON), which is capable of interfacing directly with low-voltage control signals. In TPS22922 and in TPS22922B, a 120- Ω on-chip load resistor is added for output quick discharge when switch is turned off. The rise time (slew rate) of the device is internally controlled in order to avoid inrush current: TPS22921 and TPS22922 feature a 30 μs rise time whereas TPS22922B is 200 μs .

TPS22921, TPS22922, and TPS22922B feature ultra-low quiescent and shutdown current and are available in space-saving 6-terminals wafer-chip-scale packages (WCSP: YZP and YZT with 0.5-mm pitch and YFP with 0.4-mm pitch) which make them ideal for portable electronics. The devices are characterized for operation over the free-air temperature range of -40°C to 85°C .

YFP, YZP, AND YZT PACKAGES

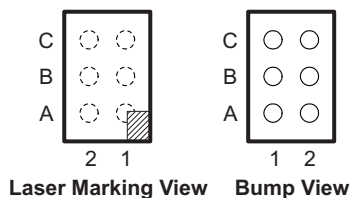

TERMINAL ASSIGNMENTS

C	ON	GND
B	V_{IN}	V_{OUT}
A	V_{IN}	V_{OUT}
	2	1



Please be aware that an important notice concerning availability, standard warranty, and use in critical applications of Texas Instruments semiconductor products and disclaimers thereto appears at the end of this data sheet.



These devices have limited built-in ESD protection. The leads should be shorted together or the device placed in conductive foam during storage or handling to prevent electrostatic damage to the MOS gates.

	r _{ON} AT 1.8 V (TYP)	SLEW RATE (TYP at 1.8 V)	QUICK OUTPUT DISCHARGE ⁽¹⁾	MAX OUTPUT CURRENT	ENABLE
TPS22921	33 mΩ	30 μs	No	2 A	active high
TPS22922	33 mΩ	30 μs	Yes	2 A	active high
TPS22922B	33 mΩ	200 μs	Yes	2 A	active high

(1) This feature discharges the output of the switch to ground through a 120-Ω resistor, preventing the output from floating.

ORDERING INFORMATION

For package and ordering information, see the Package Option Addendum at the end of this document.

TYPICAL APPLICATION

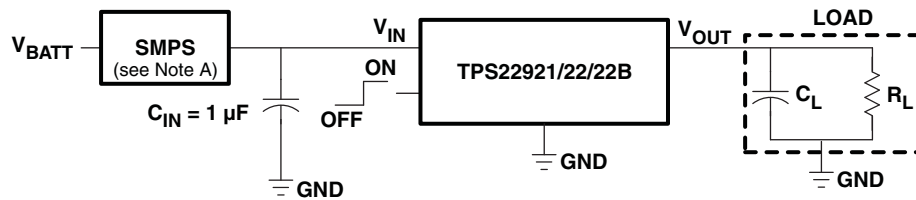

A. Switched mode power supply

APPLICATION BLOCK DIAGRAM

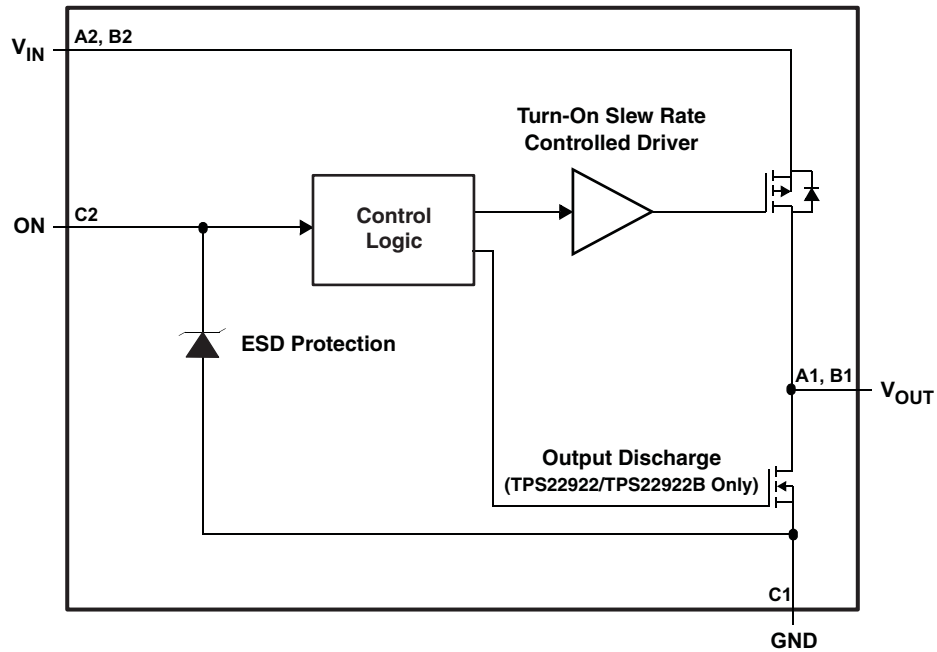

Figure 1. Functional Block Diagram

FUNCTION TABLE

ON	V _{IN} TO V _{OUT}	V _{OUT} TO GND ⁽¹⁾
L	OFF	ON
H	ON	OFF

(1) TPS22922/TPS22922B only

TERMINAL FUNCTIONS

TERMINAL		DESCRIPTION
NO.	NAME	
A1, B1	V _{OUT}	Switch output
A2, B2	V _{IN}	Switch input
C1	GND	Ground
C2	ON	Switch control input, active high. Do not leave floating

ABSOLUTE MAXIMUM RATINGS⁽¹⁾

		MIN	MAX	UNIT
V _{IN}	Input voltage range	-0.3	4	V
V _{OUT}	Output voltage range		V _{IN} + 0.3	V
V _{ON}	Input voltage range	-0.3	4	V
P	Power dissipation at T _A = 25°C		0.645	W
I _{MAX}	Maximum continuous switch current		2	A
T _A	Operating free-air temperature range	-40	85	°C
T _{stg}	Storage temperature range	-65	150	°C
T _{lead}	Maximum lead temperature (10-s soldering time)		300	°C
ESD	Electrostatic discharge protection	Human-Body Model (HBM)	3000	V
		Charged Device Model (CDM)	1000	
		Machine Model (MM)	300	

(1) Stresses beyond those listed under absolute maximum ratings may cause permanent damage to the device. These are stress ratings only, and functional operation of the device at these or any other conditions beyond those indicated under *Recommended Operating Conditions* is not implied. Exposure to absolute-maximum-rated conditions for extended periods may affect device reliability.

THERMAL IMPEDANCE RATINGS

			UNIT
θ _{JA}	Package thermal impedance ⁽¹⁾	YFP package	155
		YZP/YZT package	123

(1) The package thermal impedance is calculated in accordance with JESD 51-7.

RECOMMENDED OPERATING CONDITIONS

		MIN	MAX	UNIT
V _{IN}	Input voltage range	0.9	3.6	V
V _{OUT}	Output voltage range		V _{IN}	
V _{IH}	High-level input voltage, ON	0.85	3.6	V
V _{IL}	Low-level input voltage, ON		0.4	V
C _{IN}	Input capacitor	1 ⁽¹⁾		µF

(1) Refer to [Application Information](#).

ELECTRICAL CHARACTERISTICS

 $V_{IN} = 0.9\text{ V to }3.6\text{ V}$, $T_A = -40^\circ\text{C to }85^\circ\text{C}$ (unless otherwise noted)

PARAMETER	TEST CONDITIONS	T_A	MIN TYP ⁽¹⁾ MAX		UNIT	
			MIN	TYP		MAX
I_{IN} Quiescent current	$I_{OUT} = 0\text{ mA}$	$V_{IN} = 1\text{ V}$	Full	30	120	nA
		$V_{IN} = 1.8\text{ V}$	Full	78	235	
		$V_{IN} = 3.6\text{ V}$	Full	200	880	
$I_{IN(OFF)}$ OFF-state supply current	$V_{ON} = \text{GND}$, $V_{OUT} = \text{Open}$	$V_{IN} = 1\text{ V}$	Full	10	210	nA
		$V_{IN} = 1.8\text{ V}$	Full	35	260	
		$V_{IN} = 3.6\text{ V}$	Full	120	700	
$I_{IN(LEAKAGE)}$ OFF-state switch current	$V_{ON} = \text{GND}$, $V_{OUT} = 0\text{ V}$	$V_{IN} = 1\text{ V}$	Full	12	140	nA
		$V_{IN} = 1.8\text{ V}$	Full	50	230	
		$V_{IN} = 3.6\text{ V}$	Full	130	610	
r_{ON} ON-state resistance	$I_{OUT} = -200\text{ mA}$	$V_{IN} = 3.6\text{ V}$	25°C	14	45	mΩ
			Full		50	
		$V_{IN} = 2.5\text{ V}$	25°C	20	55	
			Full		60	
		$V_{IN} = 1.8\text{ V}$	25°C	33	65	
			Full		75	
		$V_{IN} = 1.2\text{ V}$	25°C	67	100	
			Full		120	
		$V_{IN} = 1.1\text{ V}$	25°C	82	150	
			Full		160	
		$V_{IN} = 1\text{ V}$	25°C	116	160	
			Full		170	
r_{PD} Output pulldown resistance	$V_{IN} = 3.3\text{ V}$, $V_{ON} = 0\text{ V}$, $I_{OUT} = 30\text{ mA}$ (TPS22922 and TPS22922B only)	25°C	65	120	Ω	
I_{ON} ON input leakage current	$V_{ON} = 1.1\text{ V to }3.6\text{ V or GND}$	Full		25	nA	

 (1) Typical values are at the specified V_{IN} and $T_A = 25^\circ\text{C}$.

SWITCHING CHARACTERISTICS

 $V_{IN} = 0.9\text{ V}$, $T_A = 25^\circ\text{C}$ (unless otherwise noted)

PARAMETER	TEST CONDITIONS	TPS22921			TPS22922			TPS22922B			UNIT
		MIN	TYP	MAX	MIN	TYP	MAX	MIN	TYP	MAX	
t_{ON} Turn-ON time	$R_L = 500\ \Omega$,	$C_L = 0.1\ \mu\text{F}$		121		121		638			μs
		$C_L = 1\ \mu\text{F}$		160		160		712			
		$C_L = 3\ \mu\text{F}$		188		188		799			
t_{OFF} Turn-OFF time	$R_L = 500\ \Omega$,	$C_L = 0.1\ \mu\text{F}$		46		40		40			μs
		$C_L = 1\ \mu\text{F}$		308		279		279			
		$C_L = 3\ \mu\text{F}$		975		807		807			
t_r V_{OUT} rise time	$R_L = 500\ \Omega$,	$C_L = 0.1\ \mu\text{F}$		60		60		462			μs
		$C_L = 1\ \mu\text{F}$		85		85		465			
		$C_L = 3\ \mu\text{F}$		107		107		507			
t_f V_{OUT} fall time	$R_L = 500\ \Omega$,	$C_L = 0.1\ \mu\text{F}$		119		51		51			μs
		$C_L = 1\ \mu\text{F}$		969		434		434			
		$C_L = 3\ \mu\text{F}$		3174		1264		1264			

SWITCHING CHARACTERISTICS

V_{IN} = 1.0 V, T_A = 25°C (unless otherwise noted)

PARAMETER	TEST CONDITIONS	TPS22921			TPS22922			TPS22922B			UNIT	
		MIN	TYP	MAX	MIN	TYP	MAX	MIN	TYP	MAX		
t _{ON} Turn-ON time	R _L = 500 Ω,	C _L = 0.1 μF	105			105			549			μs
		C _L = 1 μF	136			136			613			
		C _L = 3 μF	157			157			683			
t _{OFF} Turn-OFF time	R _L = 500 Ω,	C _L = 0.1 μF	46			28			28			μs
		C _L = 1 μF	309			186			186			
		C _L = 3 μF	983			511			511			
t _r V _{OUT} rise time	R _L = 500 Ω,	C _L = 0.1 μF	51			51			386			μs
		C _L = 1 μF	78			78			388			
		C _L = 3 μF	88			88			419			
t _f V _{OUT} fall time	R _L = 500 Ω,	C _L = 0.1 μF	121			34			34			μs
		C _L = 1 μF	986			306			306			
		C _L = 3 μF	3300			908			908			

SWITCHING CHARACTERISTICS

V_{IN} = 1.1 V, T_A = 25°C (unless otherwise noted)

PARAMETER	TEST CONDITIONS	TPS22921			TPS22922			TPS22922B			UNIT	
		MIN	TYP	MAX	MIN	TYP	MAX	MIN	TYP	MAX		
t _{ON} Turn-ON time	R _L = 500 Ω,	C _L = 0.1 μF	91			93			484			μs
		C _L = 1 μF	118			118			540			
		C _L = 3 μF	137			137			599			
t _{OFF} Turn-OFF time	R _L = 500 Ω,	C _L = 0.1 μF	44			21			21			μs
		C _L = 1 μF	311			144			144			
		C _L = 3 μF	99			383			383			
t _r V _{OUT} rise time	R _L = 500 Ω,	C _L = 0.1 μF	46			46			335			μs
		C _L = 1 μF	60			60			336			
		C _L = 3 μF	76			76			363			
t _f V _{OUT} fall time	R _L = 500 Ω,	C _L = 0.1 μF	122			29			29			μs
		C _L = 1 μF	1000			224			224			
		C _L = 3 μF	3300			732			732			

SWITCHING CHARACTERISTICS
 $V_{IN} = 1.2\text{ V}$, $T_A = 25^\circ\text{C}$ (unless otherwise noted)

PARAMETER	TEST CONDITIONS	TPS22921			TPS22922			TPS22922B			UNIT	
		MIN	TYP	MAX	MIN	TYP	MAX	MIN	TYP	MAX		
t_{ON} Turn-ON time	$R_L = 500\ \Omega$,	$C_L = 0.1\ \mu\text{F}$	83			83			435			μs
		$C_L = 1\ \mu\text{F}$	103			103			485			
		$C_L = 3\ \mu\text{F}$	122			122			536			
t_{OFF} Turn-OFF time	$R_L = 500\ \Omega$,	$C_L = 0.1\ \mu\text{F}$	44			17			17			μs
		$C_L = 1\ \mu\text{F}$	312			117			117			
		$C_L = 3\ \mu\text{F}$	1000			319			319			
t_r V_{OUT} rise time	$R_L = 500\ \Omega$,	$C_L = 0.1\ \mu\text{F}$	41			41			301			μs
		$C_L = 1\ \mu\text{F}$	54			54			302			
		$C_L = 3\ \mu\text{F}$	67			67			325			
t_f V_{OUT} fall time	$R_L = 500\ \Omega$,	$C_L = 0.1\ \mu\text{F}$	123			25			25			μs
		$C_L = 1\ \mu\text{F}$	1000			214			214			
		$C_L = 3\ \mu\text{F}$	3400			632			632			

SWITCHING CHARACTERISTICS
 $V_{IN} = 1.8\text{ V}$, $T_A = 25^\circ\text{C}$ (unless otherwise noted)

PARAMETER	TEST CONDITIONS	TPS22921			TPS22922			TPS22922B			UNIT	
		MIN	TYP	MAX	MIN	TYP	MAX	MIN	TYP	MAX		
t_{ON} Turn-ON time	$R_L = 500\ \Omega$,	$C_L = 0.1\ \mu\text{F}$	54			54			282			μs
		$C_L = 1\ \mu\text{F}$	67			67			314			
		$C_L = 3\ \mu\text{F}$	78			78			344			
t_{OFF} Turn-OFF time	$R_L = 500\ \Omega$,	$C_L = 0.1\ \mu\text{F}$	41			10			10			μs
		$C_L = 1\ \mu\text{F}$	312			67			67			
		$C_L = 3\ \mu\text{F}$	1000			181			181			
t_r V_{OUT} rise time	$R_L = 500\ \Omega$,	$C_L = 0.1\ \mu\text{F}$	30			30			200			μs
		$C_L = 1\ \mu\text{F}$	37			37			202			
		$C_L = 3\ \mu\text{F}$	47			47			219			
t_f V_{OUT} fall time	$R_L = 500\ \Omega$,	$C_L = 0.1\ \mu\text{F}$	121			17			17			μs
		$C_L = 1\ \mu\text{F}$	1000			158			158			
		$C_L = 3\ \mu\text{F}$	3450			461			461			

SWITCHING CHARACTERISTICS

$V_{IN} = 2.5\text{ V}$, $T_A = 25^\circ\text{C}$ (unless otherwise noted)

PARAMETER	TEST CONDITIONS	TPS22921			TPS22922			TPS22922B			UNIT	
		MIN	TYP	MAX	MIN	TYP	MAX	MIN	TYP	MAX		
t_{ON} Turn-ON time	$R_L = 500\ \Omega$,	$C_L = 0.1\ \mu\text{F}$	40			40			211			μs
		$C_L = 1\ \mu\text{F}$	50			50			233			
		$C_L = 3\ \mu\text{F}$	59			59			256			
t_{OFF} Turn-OFF time	$R_L = 500\ \Omega$,	$C_L = 0.1\ \mu\text{F}$	41			10			10			μs
		$C_L = 1\ \mu\text{F}$	316			56			56			
		$C_L = 3\ \mu\text{F}$	1000			153			153			
t_r V_{OUT} rise time	$R_L = 500\ \Omega$,	$C_L = 0.1\ \mu\text{F}$	23			23			164			μs
		$C_L = 1\ \mu\text{F}$	29			29			165			
		$C_L = 3\ \mu\text{F}$	38			38			177			
t_f V_{OUT} fall time	$R_L = 500\ \Omega$,	$C_L = 0.1\ \mu\text{F}$	122			16			16			μs
		$C_L = 1\ \mu\text{F}$	1086			147			147			
		$C_L = 3\ \mu\text{F}$	3600			430			430			

SWITCHING CHARACTERISTICS

$V_{IN} = 3\text{ V}$, $T_A = 25^\circ\text{C}$ (unless otherwise noted)

PARAMETER	TEST CONDITIONS	TPS22921			TPS22922			TPS22922B			UNIT	
		MIN	TYP	MAX	MIN	TYP	MAX	MIN	TYP	MAX		
t_{ON} Turn-ON time	$R_L = 500\ \Omega$,	$C_L = 0.1\ \mu\text{F}$	30			30			182			μs
		$C_L = 1\ \mu\text{F}$	38			38			201			
		$C_L = 3\ \mu\text{F}$	45			45			221			
t_{OFF} Turn-OFF time	$R_L = 500\ \Omega$,	$C_L = 0.1\ \mu\text{F}$	40			10			10			μs
		$C_L = 1\ \mu\text{F}$	353			51			51			
		$C_L = 3\ \mu\text{F}$	1036			139			139			
t_r V_{OUT} rise time	$R_L = 500\ \Omega$,	$C_L = 0.1\ \mu\text{F}$	20			20			149			μs
		$C_L = 1\ \mu\text{F}$	25			25			150			
		$C_L = 3\ \mu\text{F}$	33			33			161			
t_f V_{OUT} fall time	$R_L = 500\ \Omega$,	$C_L = 0.1\ \mu\text{F}$	104			15			15			μs
		$C_L = 1\ \mu\text{F}$	1030			143			143			
		$C_L = 3\ \mu\text{F}$	3230			419			419			

SWITCHING CHARACTERISTICS
 $V_{IN} = 3.6\text{ V}$, $T_A = 25^\circ\text{C}$ (unless otherwise noted)

PARAMETER	TEST CONDITIONS	TPS22921			TPS22922			TPS22922B			UNIT
		MIN	TYP	MAX	MIN	TYP	MAX	MIN	TYP	MAX	
t_{ON} Turn-ON time	$R_L = 500\ \Omega$,	$C_L = 0.1\ \mu\text{F}$		30		30		159		μs	
		$C_L = 1\ \mu\text{F}$		38		38		175			
		$C_L = 3\ \mu\text{F}$		45		45		193			
t_{OFF} Turn-OFF time	$R_L = 500\ \Omega$,	$C_L = 0.1\ \mu\text{F}$		42		10		10		μs	
		$C_L = 1\ \mu\text{F}$		310		51		51			
		$C_L = 3\ \mu\text{F}$		988		139		139			
t_r V_{OUT} rise time	$R_L = 500\ \Omega$,	$C_L = 0.1\ \mu\text{F}$		20		20		137		μs	
		$C_L = 1\ \mu\text{F}$		25		25		138			
		$C_L = 3\ \mu\text{F}$		33		33		148			
t_f V_{OUT} fall time	$R_L = 500\ \Omega$,	$C_L = 0.1\ \mu\text{F}$		120		15		15		μs	
		$C_L = 1\ \mu\text{F}$		1100		143		143			
		$C_L = 3\ \mu\text{F}$		3600		419		419			

TYPICAL CHARACTERISTICS

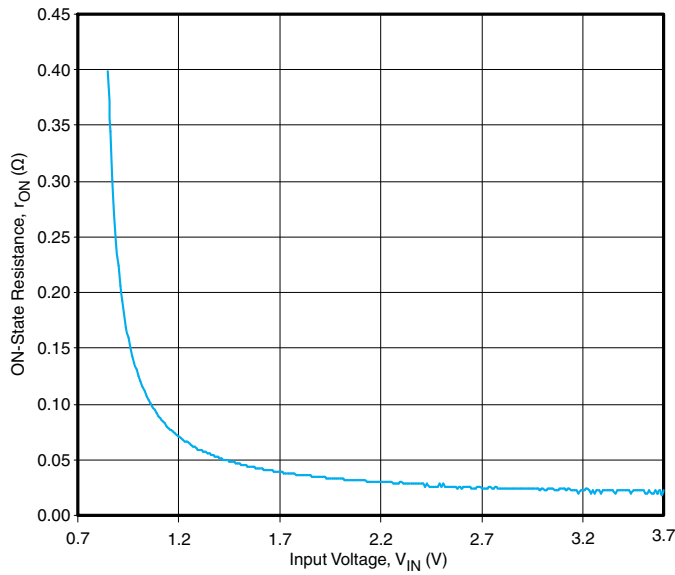

Figure 2. r_{ON} vs. V_{IN}

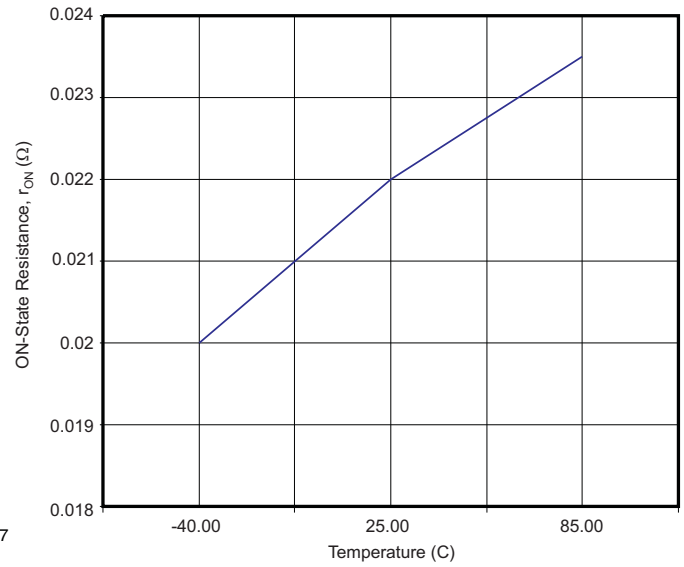

Figure 3. r_{ON} vs. Temperature ($V_{IN} = 3.3\text{ V}$)

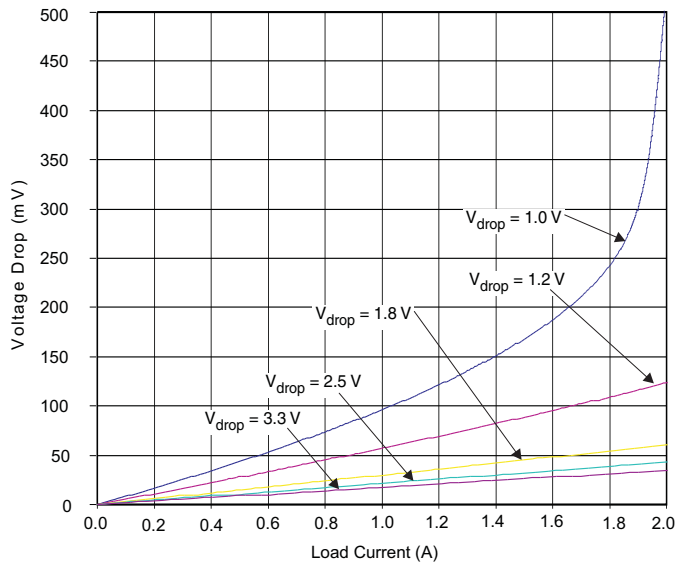

Figure 4. Voltage Drop vs Load Current

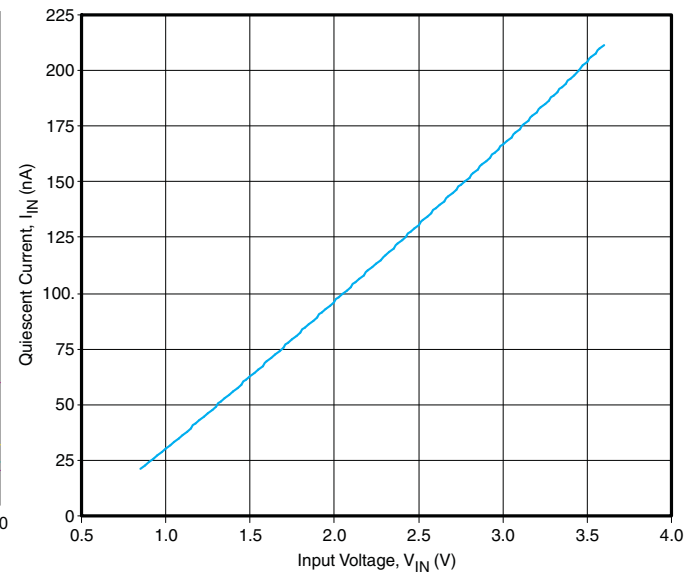

Figure 5. Quiescent Current vs. V_{IN} ($V_{ON} = V_{IN}$)

TYPICAL CHARACTERISTICS (continued)

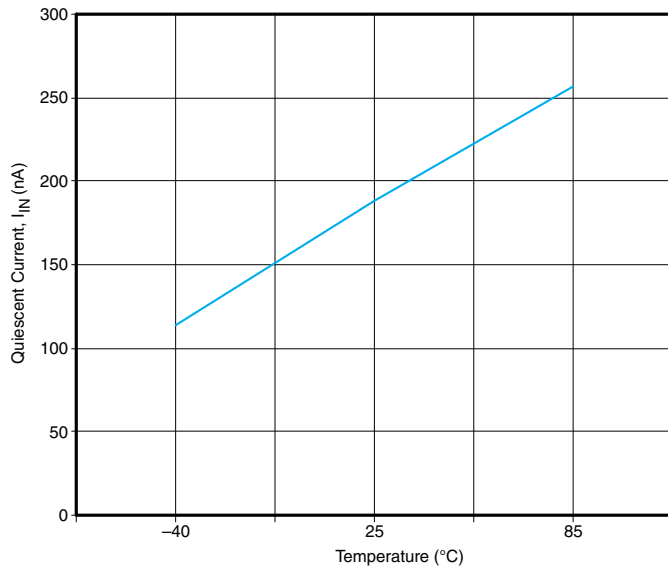

Figure 6. Quiescent Current vs. Temperature ($V_{IN} = 3.3\text{ V}$, $I_{OUT} = 0\text{ mA}$)

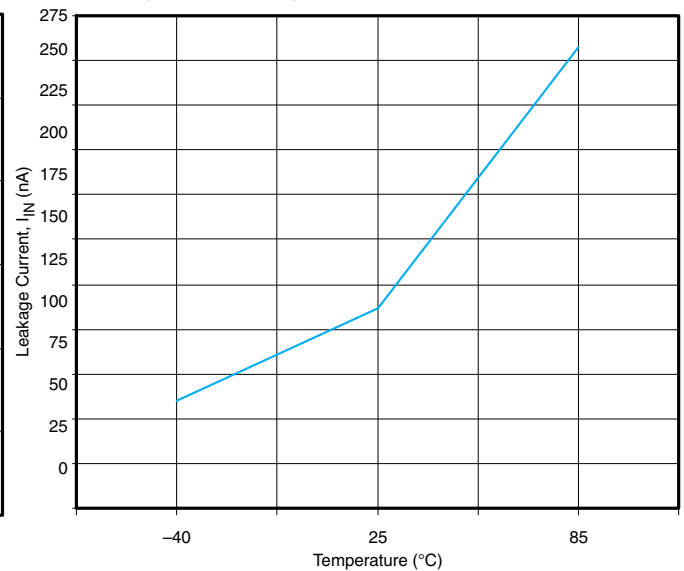

Figure 7. I_{IN} Leakage Current vs. Temperature ($V_{IN} = 3.3\text{ V}$)

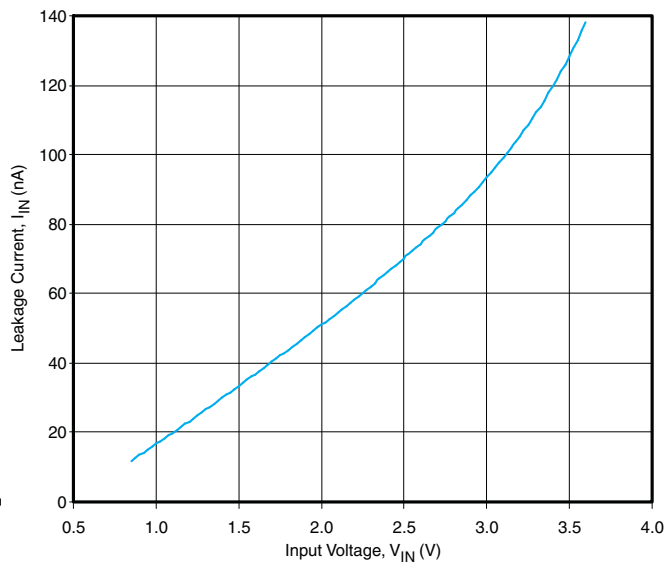

Figure 8. Leakage Current vs V_{IN}

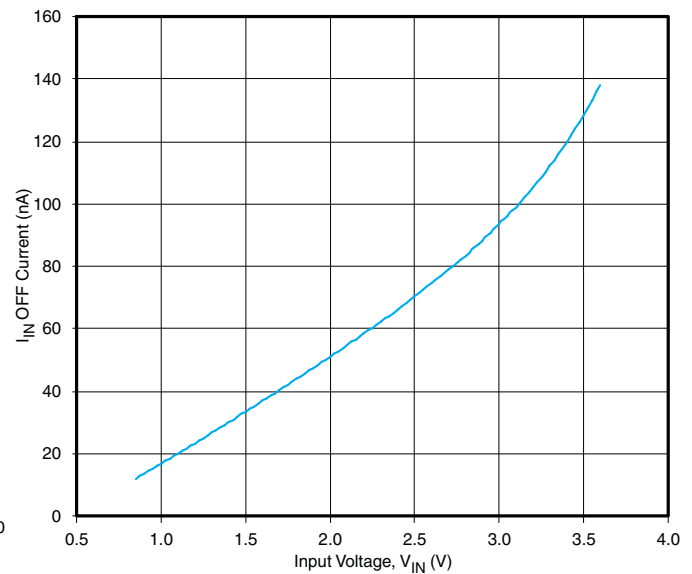

Figure 9. I_{IN} (OFF) vs V_{IN} ($V_{ON} = 0\text{ V}$)

TYPICAL CHARACTERISTICS (continued)

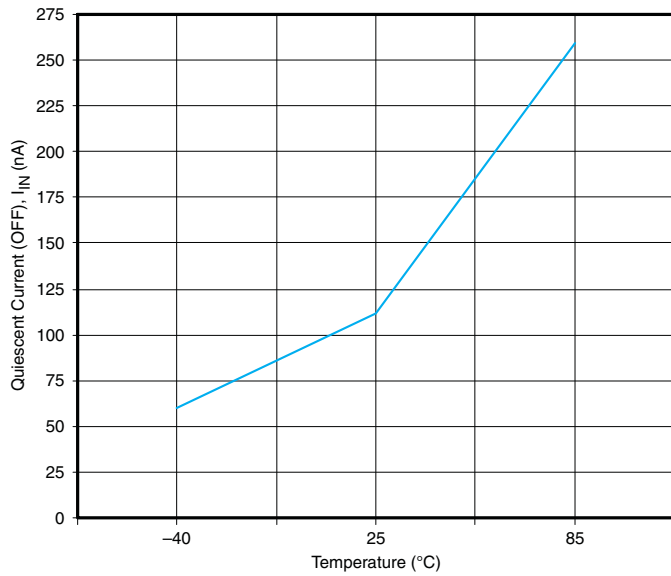

Figure 10. I_{IN} (OFF) vs Temperature ($V_{IN} = 3.3$ V)

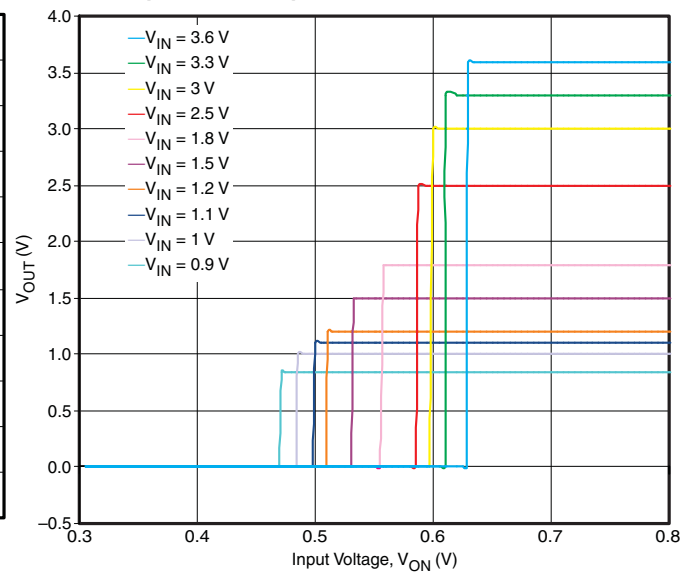

Figure 11. ON-Input Threshold

TPS22921

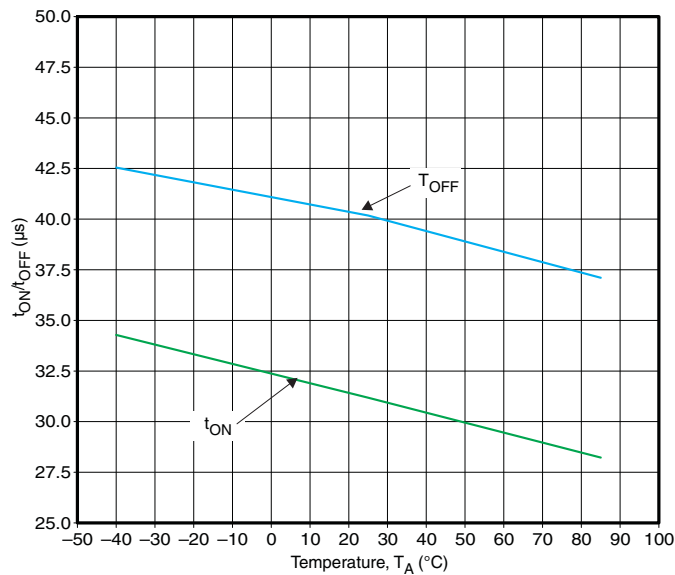

Figure 12. t_{ON}/t_{OFF} vs Temperature ($V_{IN} = 3.3$ V)

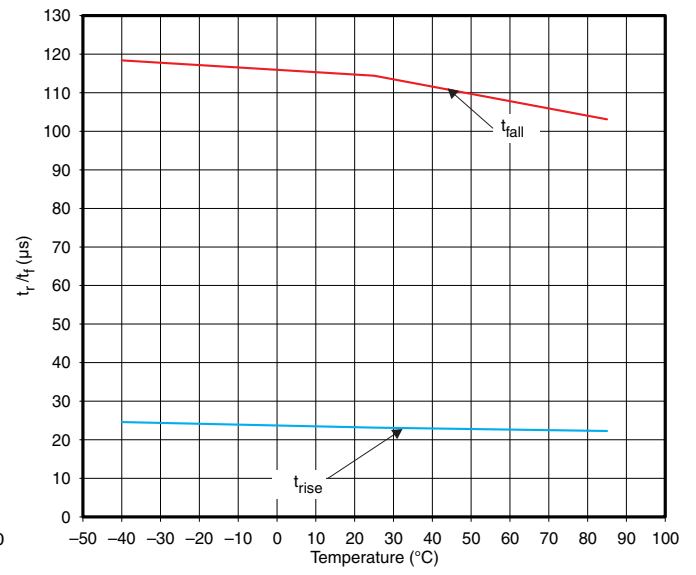

Figure 13. t_{rise}/t_{fall} vs Temperature ($V_{IN} = 3.3$ V)

TPS22922

TYPICAL CHARACTERISTICS (continued)

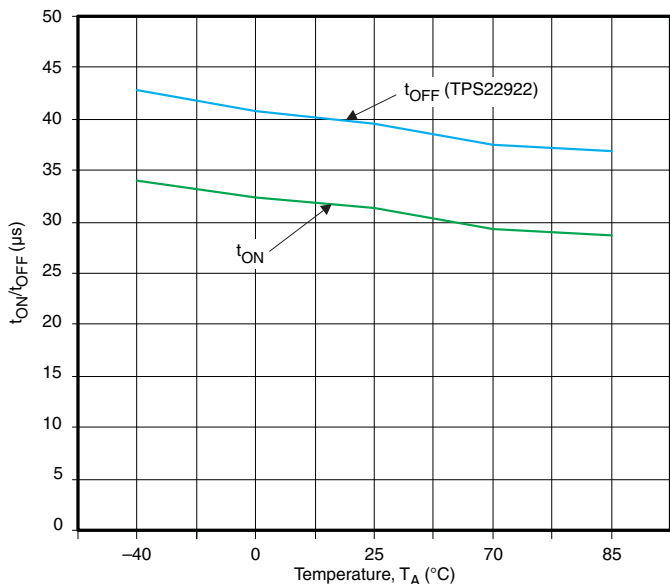

Figure 14. t_{ON}/t_{OFF} vs Temperature (V_{IN} = 3.3 V)

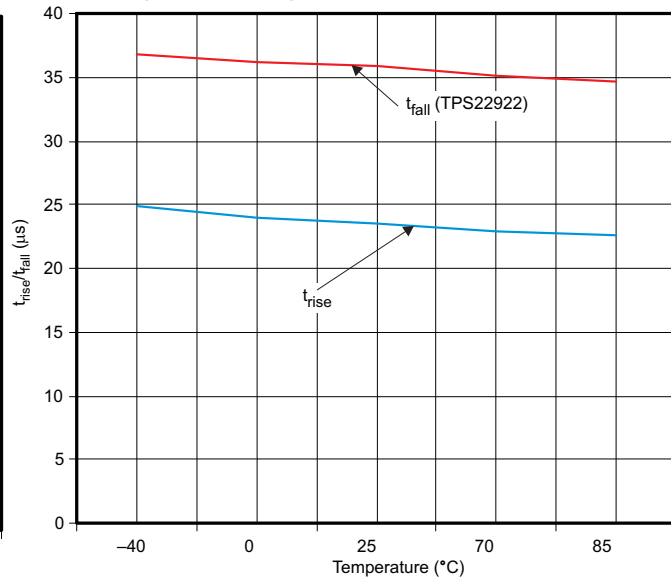

Figure 15. t_{rise}/t_{fall} vs Temperature (V_{IN} = 3.3 V)

TPS22922B

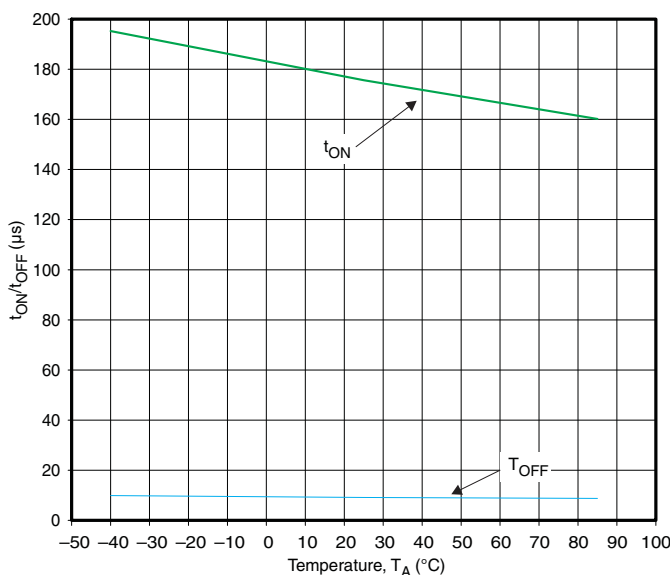

Figure 16. t_{ON}/t_{OFF} vs Temperature (V_{IN} = 3.3 V)

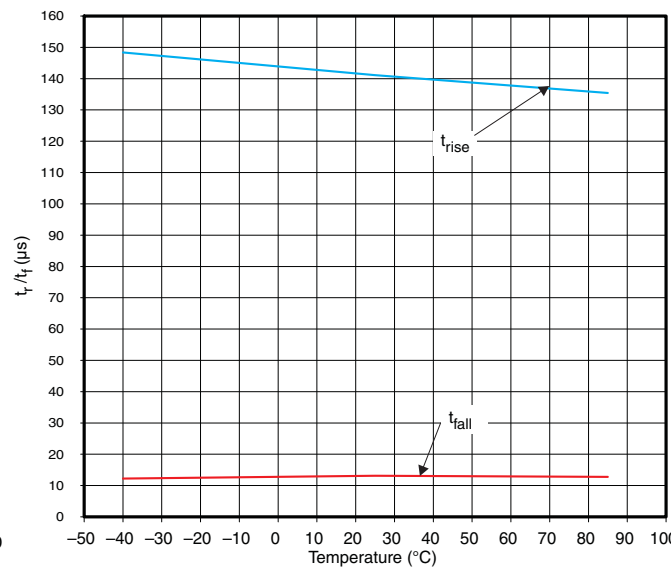

Figure 17. t_{rise}/t_{fall} vs Temperature (V_{IN} = 3.3 V)

TPS22921 and TPS22922

TYPICAL CHARACTERISTICS (continued)

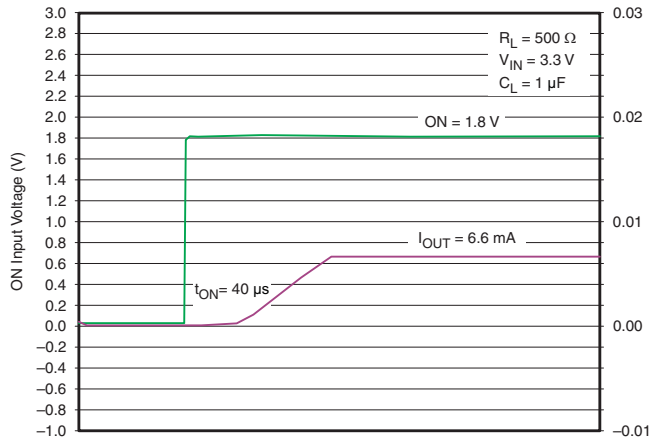

Figure 18. t_{ON} Response

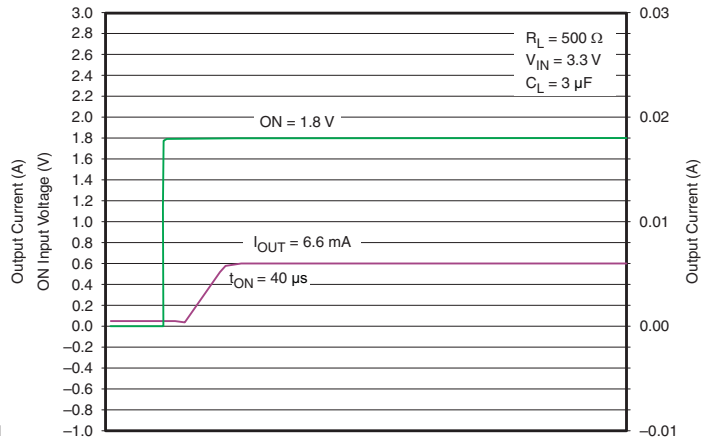

Figure 19. t_{ON} Response

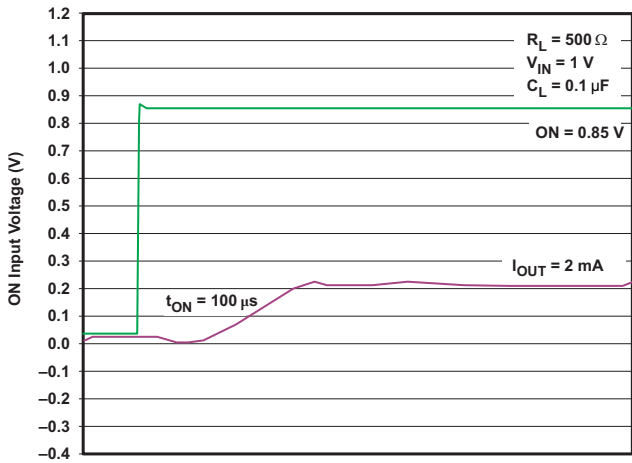

Figure 20. t_{ON} Response

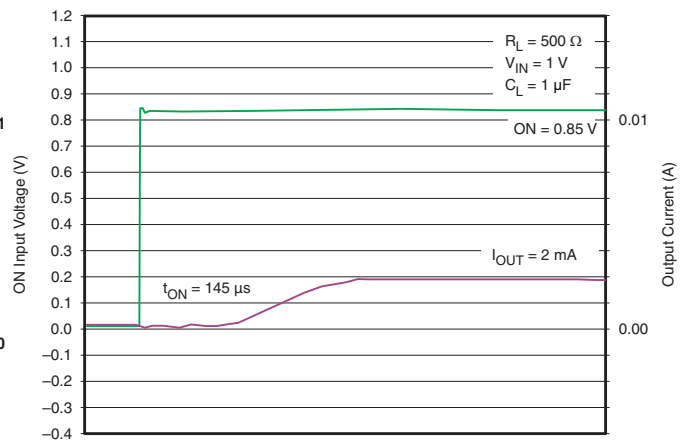

Figure 21. t_{ON} Response

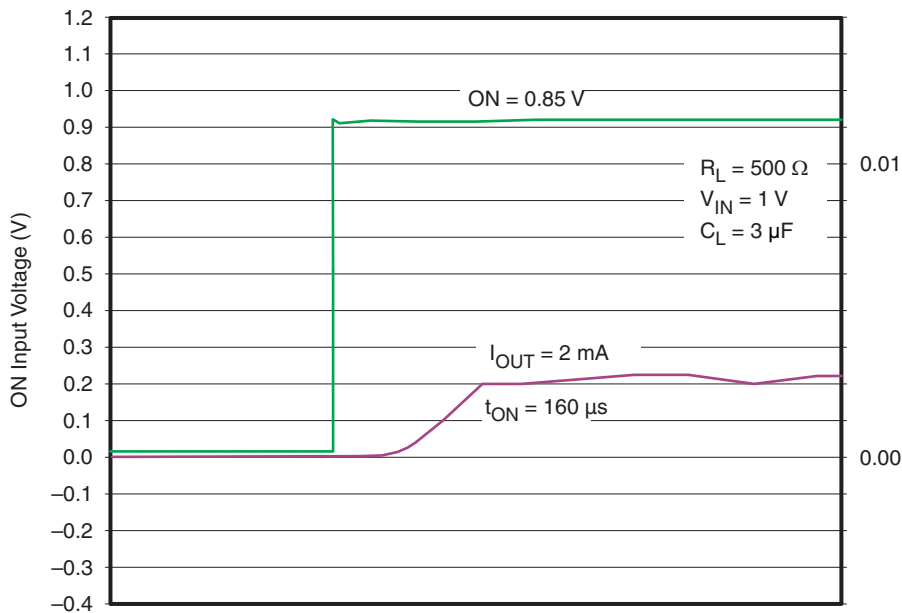

Figure 22. t_{ON} Response

TYPICAL CHARACTERISTICS (continued)

TPS22921

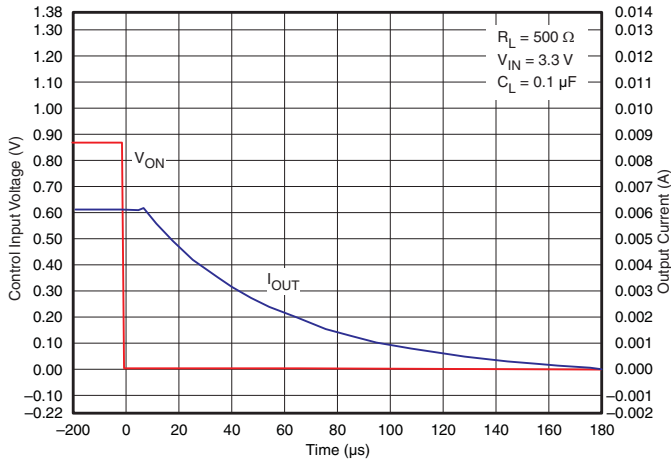

Figure 23. t_{OFF} Response

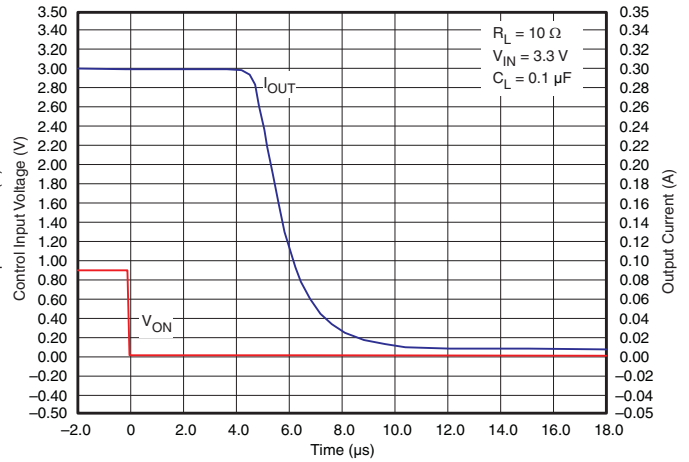

Figure 24. t_{OFF} Response

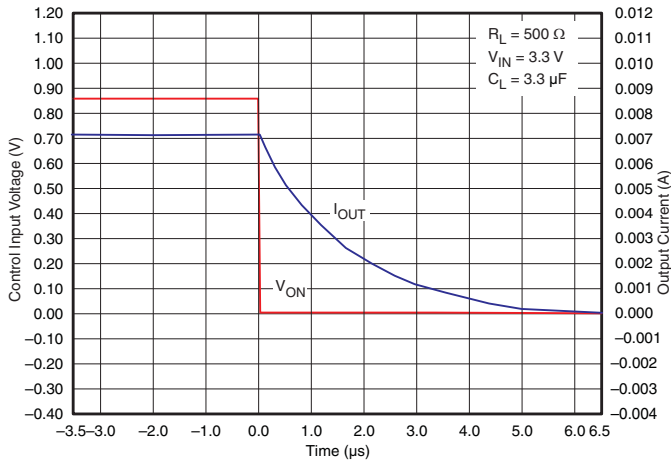

Figure 25. t_{OFF} Response

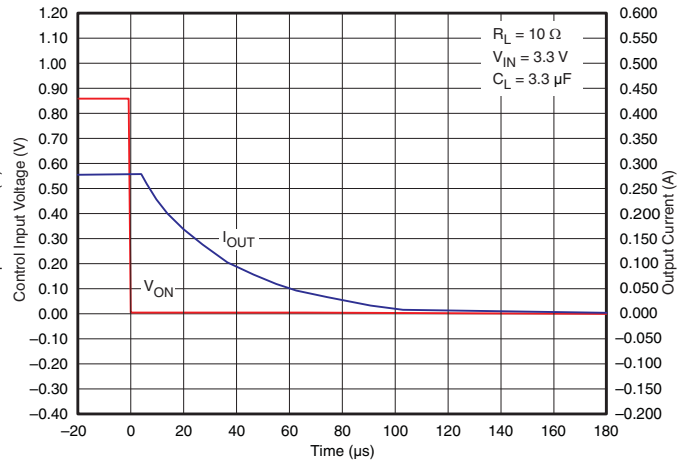

Figure 26. t_{OFF} Response

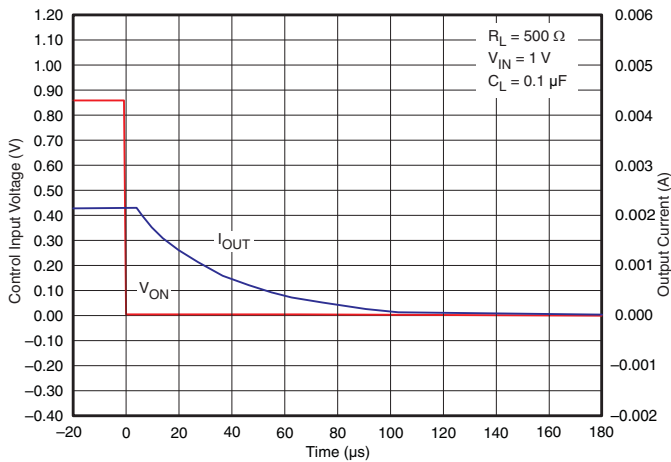

Figure 27. t_{OFF} Response

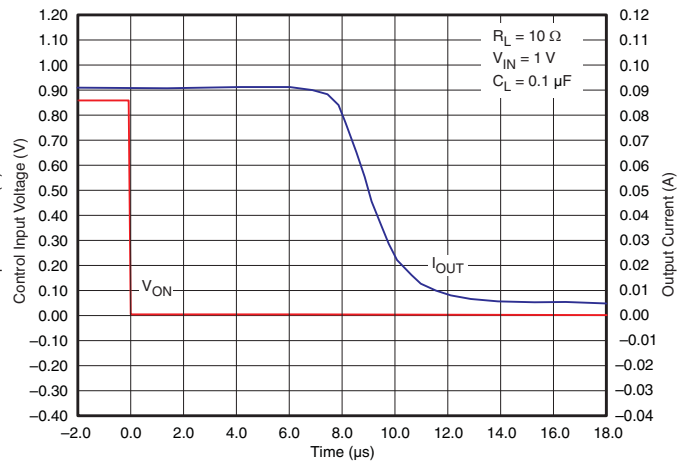

Figure 28. t_{OFF} Response

TYPICAL CHARACTERISTICS (continued)

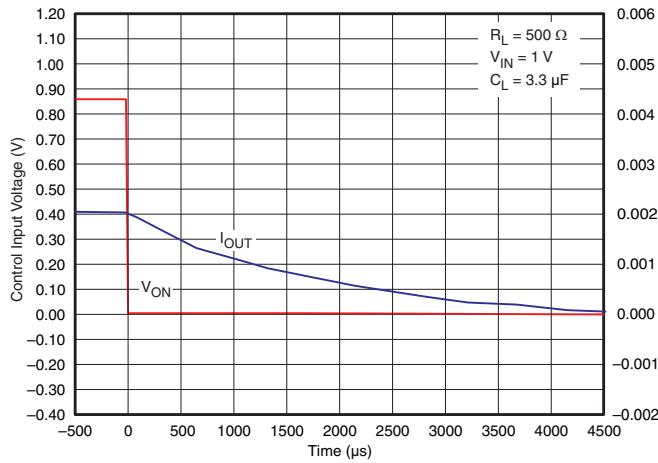

Figure 29. t_{OFF} Response

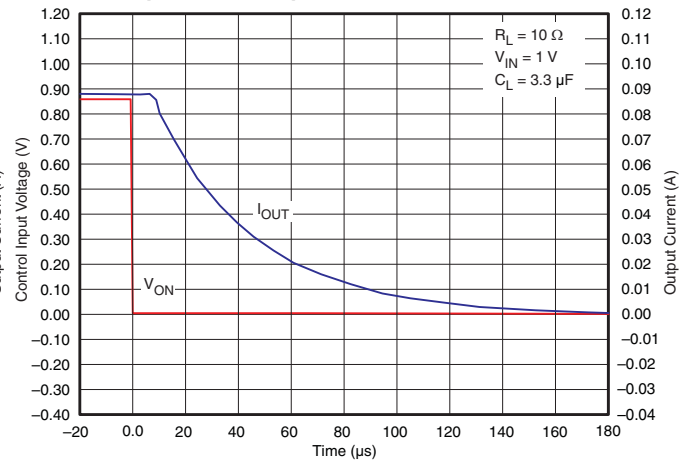

Figure 30. t_{OFF} Response

TPS22922

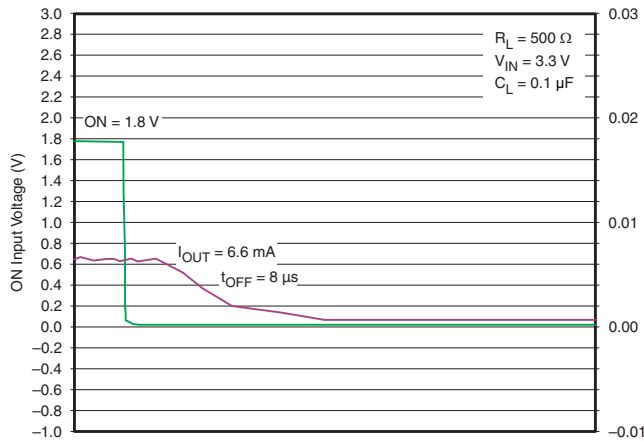

Figure 31. t_{OFF} Response

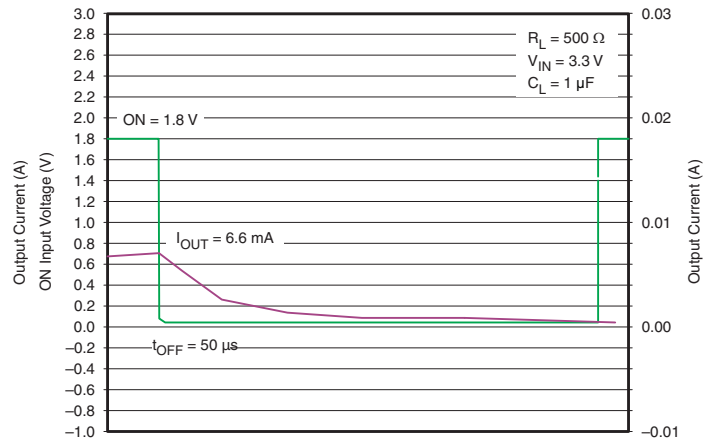

Figure 32. t_{OFF} Response

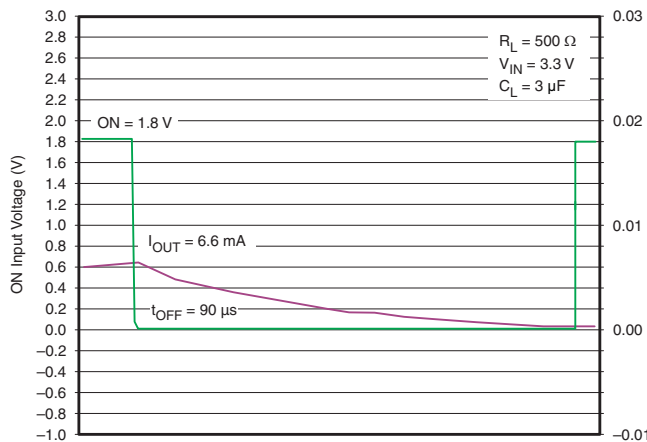

Figure 33. t_{OFF} Response

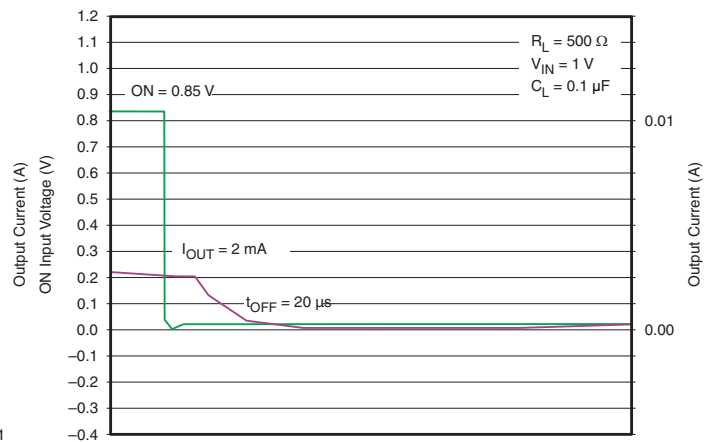

Figure 34. t_{OFF} Response

TYPICAL CHARACTERISTICS (continued)

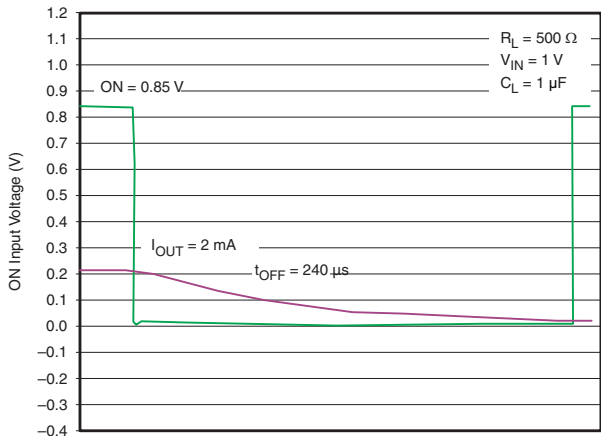

Figure 35. t_{OFF} Response

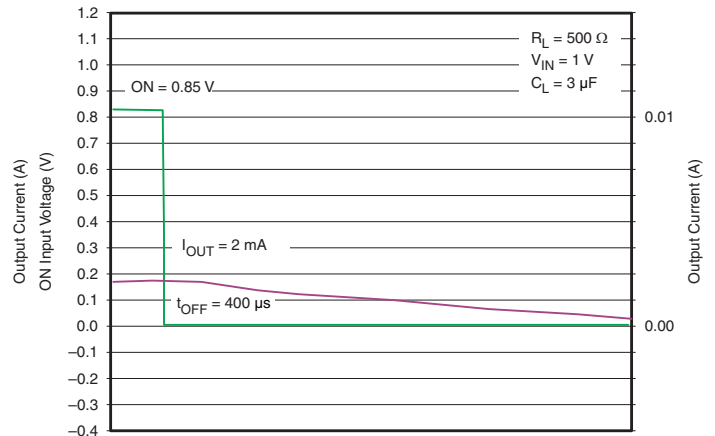

Figure 36. t_{OFF} Response

TPS22922B

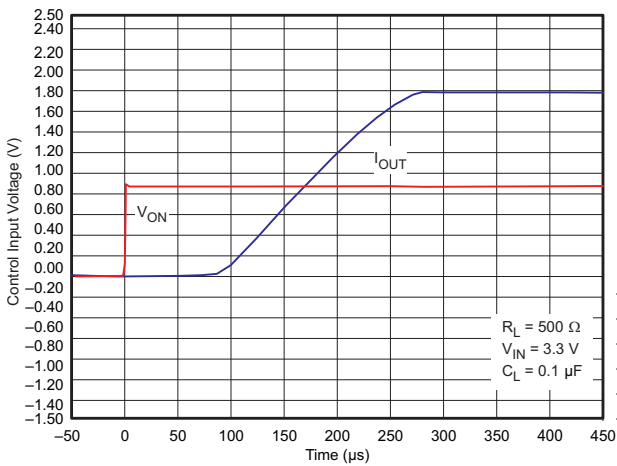

Figure 37. t_{ON} Response

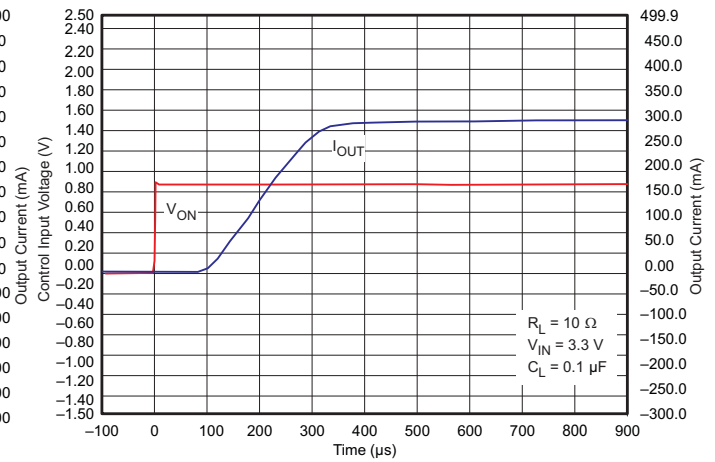

Figure 38. t_{ON} Response

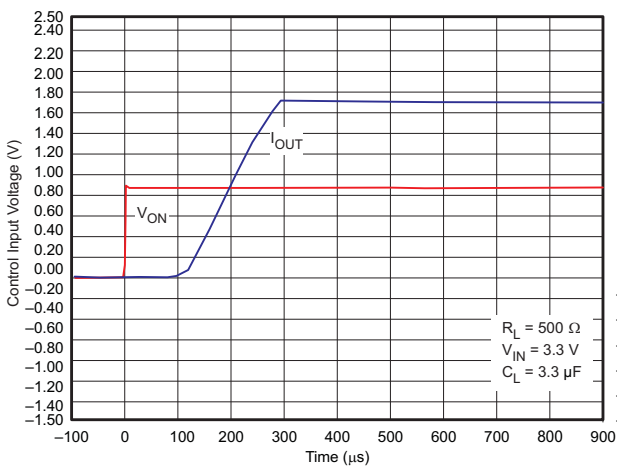

Figure 39. t_{ON} Response

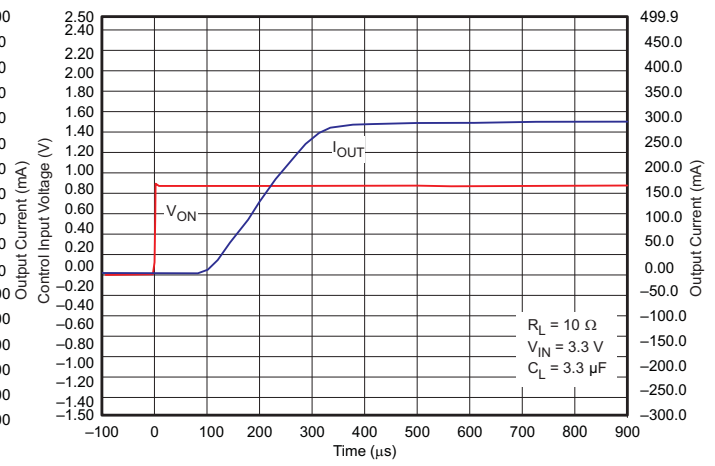

Figure 40. t_{ON} Response

TYPICAL CHARACTERISTICS (continued)

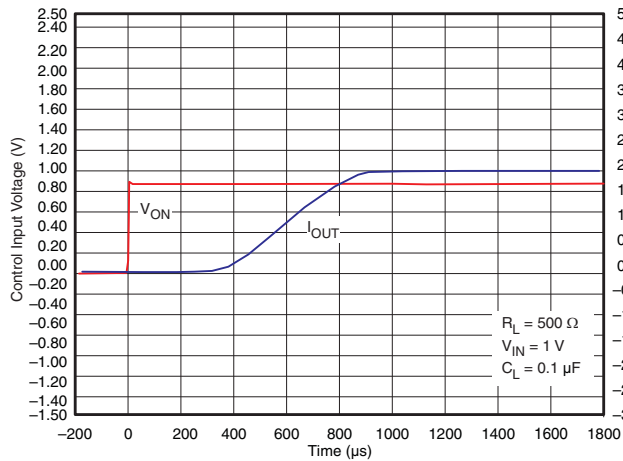

Figure 41. t_{ON} Response

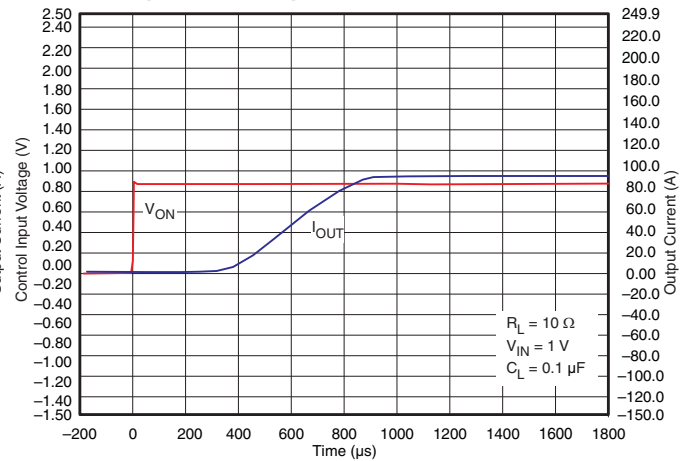

Figure 42. t_{ON} Response

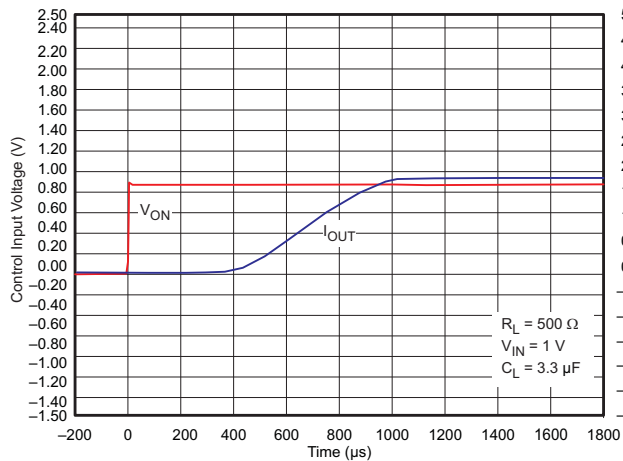

Figure 43. t_{ON} Response

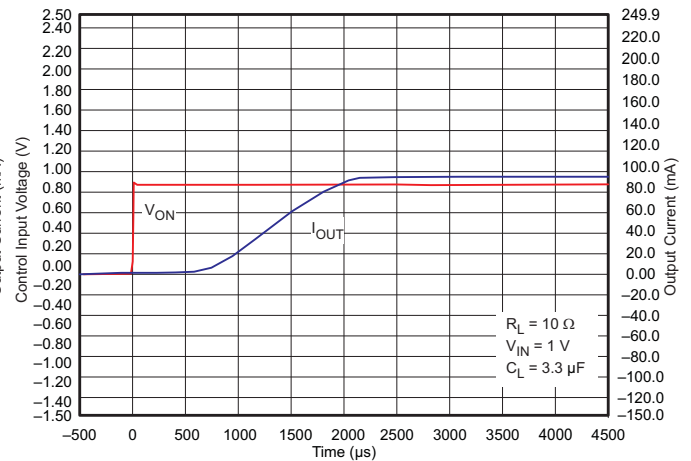

Figure 44. t_{ON} Response

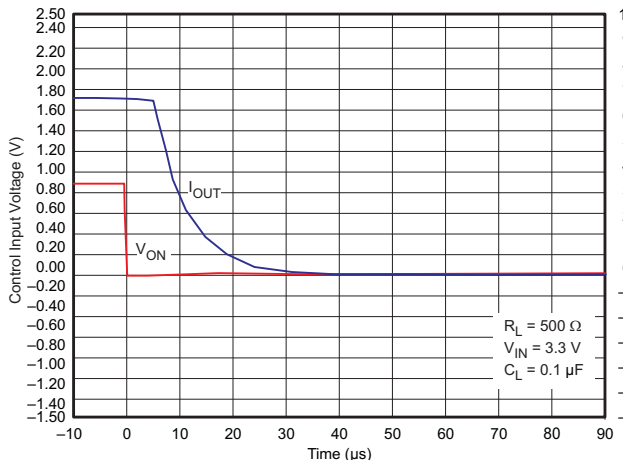

Figure 45. t_{OFF} Response

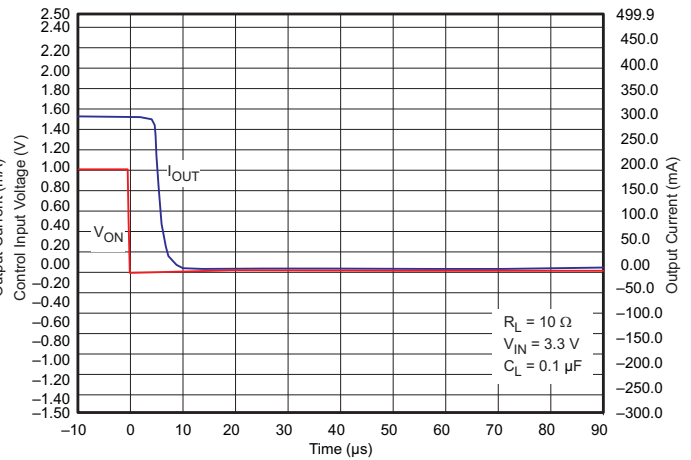

Figure 46. t_{OFF} Response

TYPICAL CHARACTERISTICS (continued)

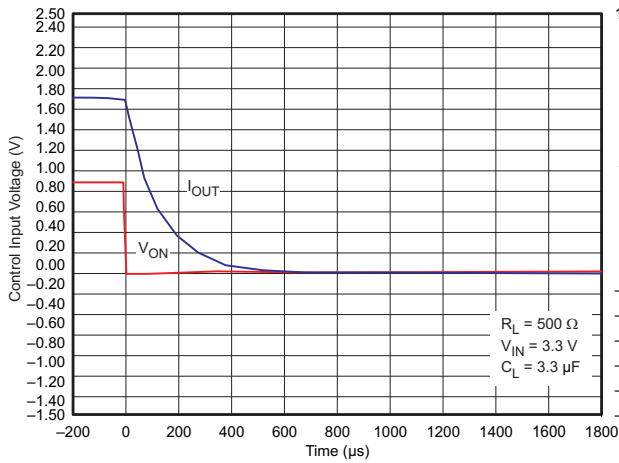

Figure 47. t_{OFF} Response

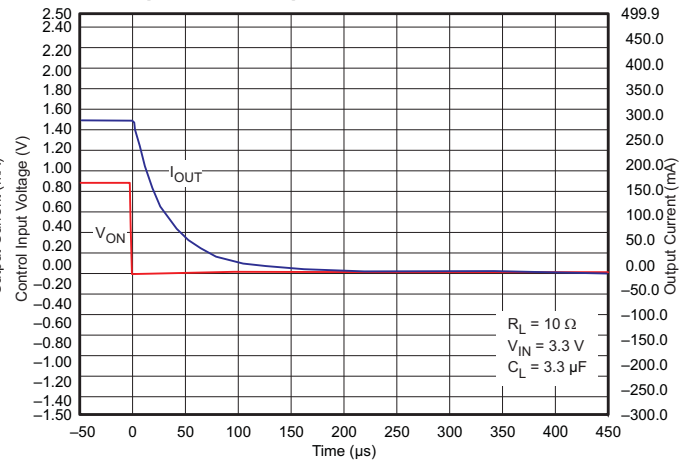

Figure 48. t_{OFF} Response

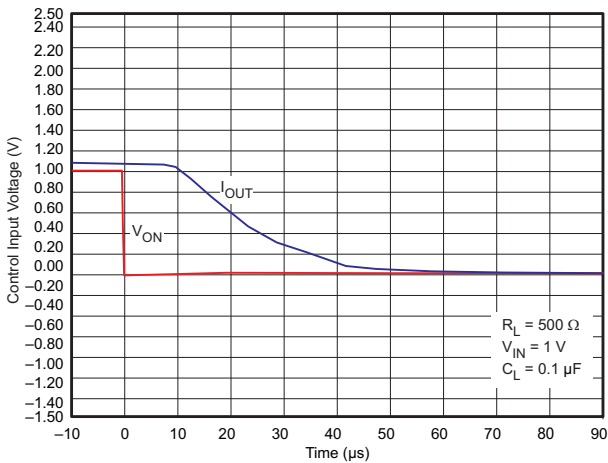

Figure 49. t_{OFF} Response

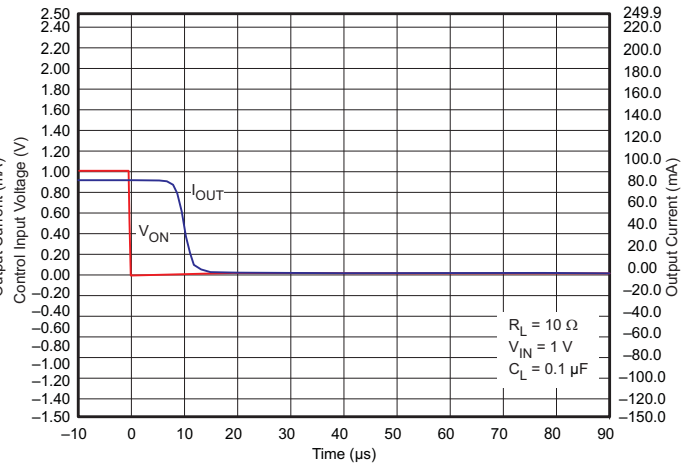

Figure 50. t_{OFF} Response

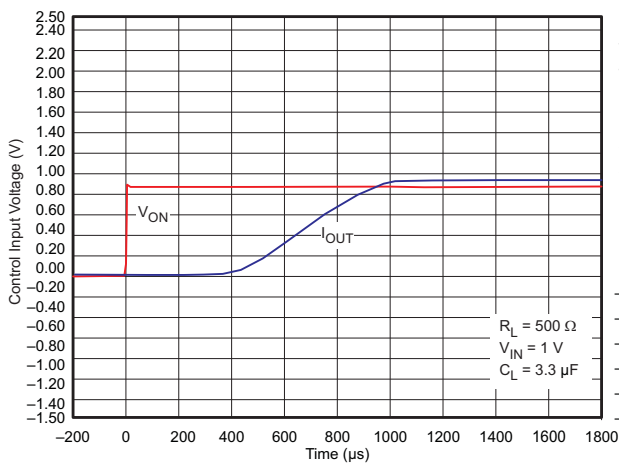

Figure 51. t_{ON} Response

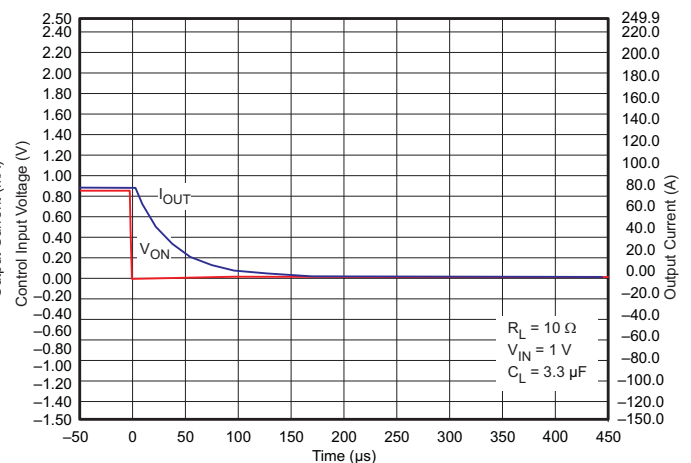

Figure 52. t_{OFF} Response

PARAMETER MEASUREMENT INFORMATION

A. t_{rise} and t_{fall} of the control signal is 100 ns.

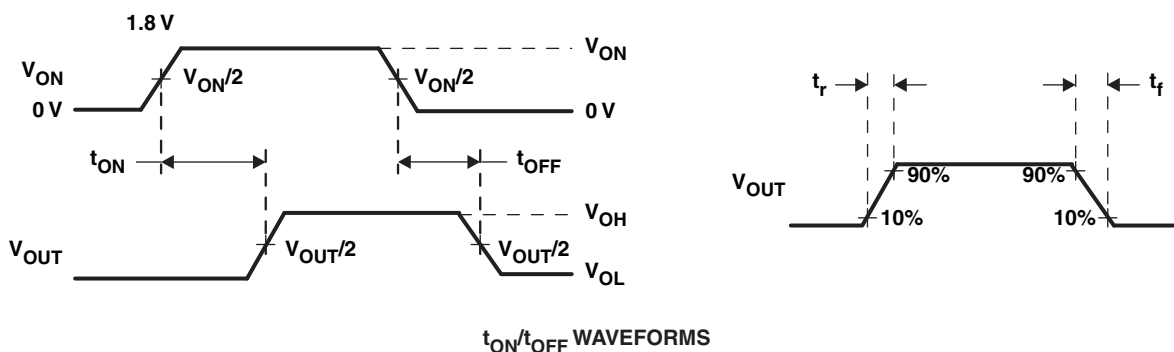
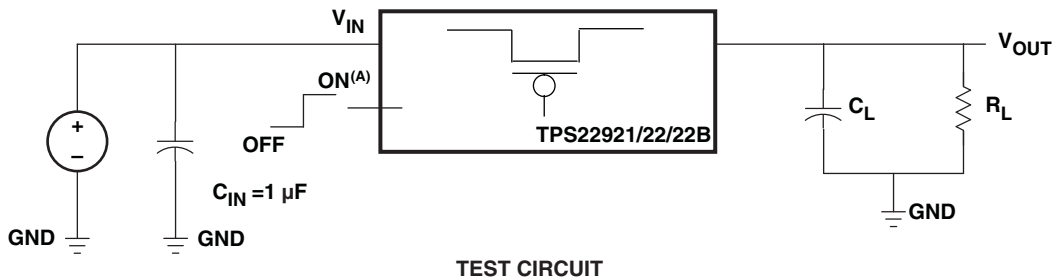

Figure 53. Test Circuit and t_{ON}/t_{OFF} Waveforms

APPLICATION INFORMATION

ON/OFF Control

The ON pin controls the state of the switch. Activating ON continuously holds the switch in the on state. ON is active high and has a low threshold making it capable of interfacing with low voltage signals. The ON pin is compatible with standard GPIO logic threshold. It can be used with any microcontroller with 1.2-V, 1.8-V, 2.5-V or 3.3-V GPIOs.

Input Capacitor

To limit the voltage drop on the input supply caused by transient inrush currents when the switch turns on into a discharged load capacitor or short-circuit, a capacitor must be placed between V_{IN} and GND. A 1- μ F ceramic capacitor, C_{IN} , placed close to the pins is usually sufficient. Higher values of C_{IN} can be used to further reduce the voltage drop during higher current application. When switching a heavy load, it is recommended to have an input capacitor about 10 or more times higher than the output capacitor in order to avoid any supply drop.

Output Capacitor

Due to the integral body diode in the PMOS switch, a C_{IN} greater than C_L is highly recommended. A C_L greater than C_{IN} can cause V_{OUT} to exceed V_{IN} when the system supply is removed. This could result in current flow through the body diode from V_{OUT} to V_{IN} .

Board Layout

For best performance, all traces should be as short as possible. To be most effective, the input and output capacitors should be placed close to the device to minimize the effects that parasitic trace inductances may have on normal and short-circuit operation. Using wide traces for V_{IN} , V_{OUT} , and GND will help minimize the parasitic electrical effects along with minimizing the case to ambient thermal impedance.

REVISION HISTORY

Changes from Original (November 2008) to Revision A	Page
• Added Note A to the TYPICAL APPLICATION circuit	2
• Changed text in the ON/OFF Control section, deleted sentence: "When the MOSFET is off, the body diode is disabled so no current can flow through it."	21
Changes from Revision A (December 2008) to Revision B	
• Changed Feature From: Ultra-Low Quiescent Current: 78 nA at 1.8 V To: Ultra-Low Quiescent Current: Typical 78 nA at 1.8 V	1
• Changed Feature From: Typical 78 nA at 1.8 V To: Ultra-Low Shutdown Current: Typical 35 nA at 1.8 V	1
• Added Feature: Typical Rise Times at $V_{IN} = 1.8\text{ V}$	1
• Changed Feature From: Six Terminal Wafer-Chip-Scale Package To: Six Terminal Wafer-Chip-Scale Package (nominal dimensions shown - see addendum for details)	1
• Changed Feature From: 0.5-mm Height To: 0.5-mm Height (YFP)	1
• Changed TPS22921 QUICK OUTPUT DISCHARGE From: - To: No	2
• Changed the format of the ELECTRICAL CHARACTERISTICS Test Conditions From: $V_{IN} = 1\text{-V}$ to $V_{IN} = 1\text{ V}$	5
• Deleted Note 1 - $RL_{CHIP} = 120\ \Omega$ from all SWITCHING CHARACTERISTICS tables	5
• Changed Figure 51 title From: t_{OFF} Response To: t_{ON} Response	19
• Changed text in the ON/OFF Control section From: "Activating ON continuously holds the switch in the on state so long as there is no fault." To: "Activating ON continuously holds the switch in the on state."	21

YZP (R-XBGA-N6)

DIE-SIZE BALL GRID ARRAY

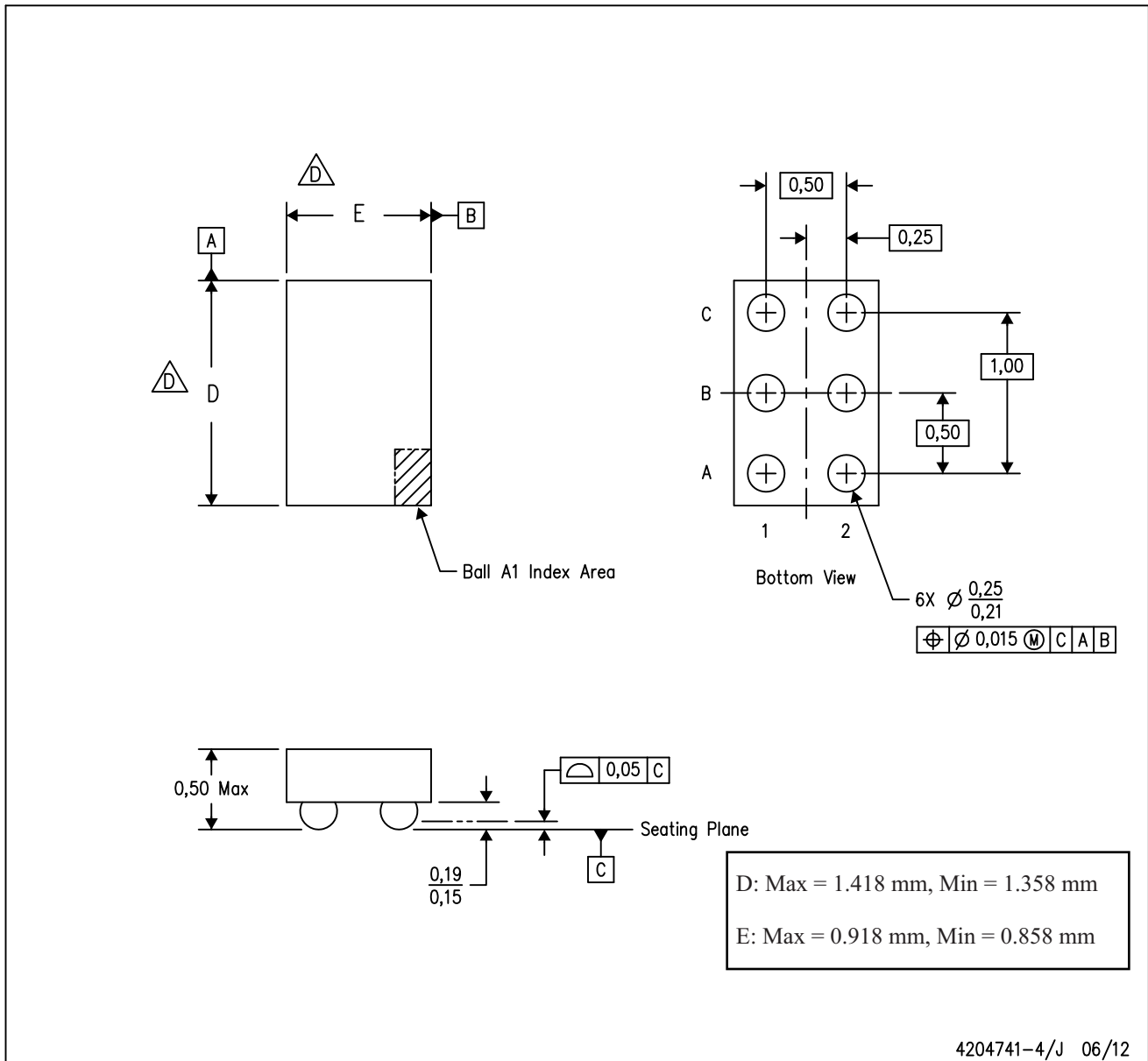



- NOTES:
- A. All linear dimensions are in millimeters. Dimensioning and tolerancing per ASME Y14.5M-1994.
 - B. This drawing is subject to change without notice.
 - C. NanoFree™ package configuration.
 - The package size (Dimension D and E) of a particular device is specified in the device Product Data Sheet version of this drawing, in case it cannot be found in the product data sheet please contact a local TI representative.
 - E. This package is a Pb-free solder ball design. Refer to the 6 YEP package (drawing 4204725) for tin-lead (SnPb).

NanoFree is a trademark of Texas Instruments.

YZT (R-XBGA-N6)

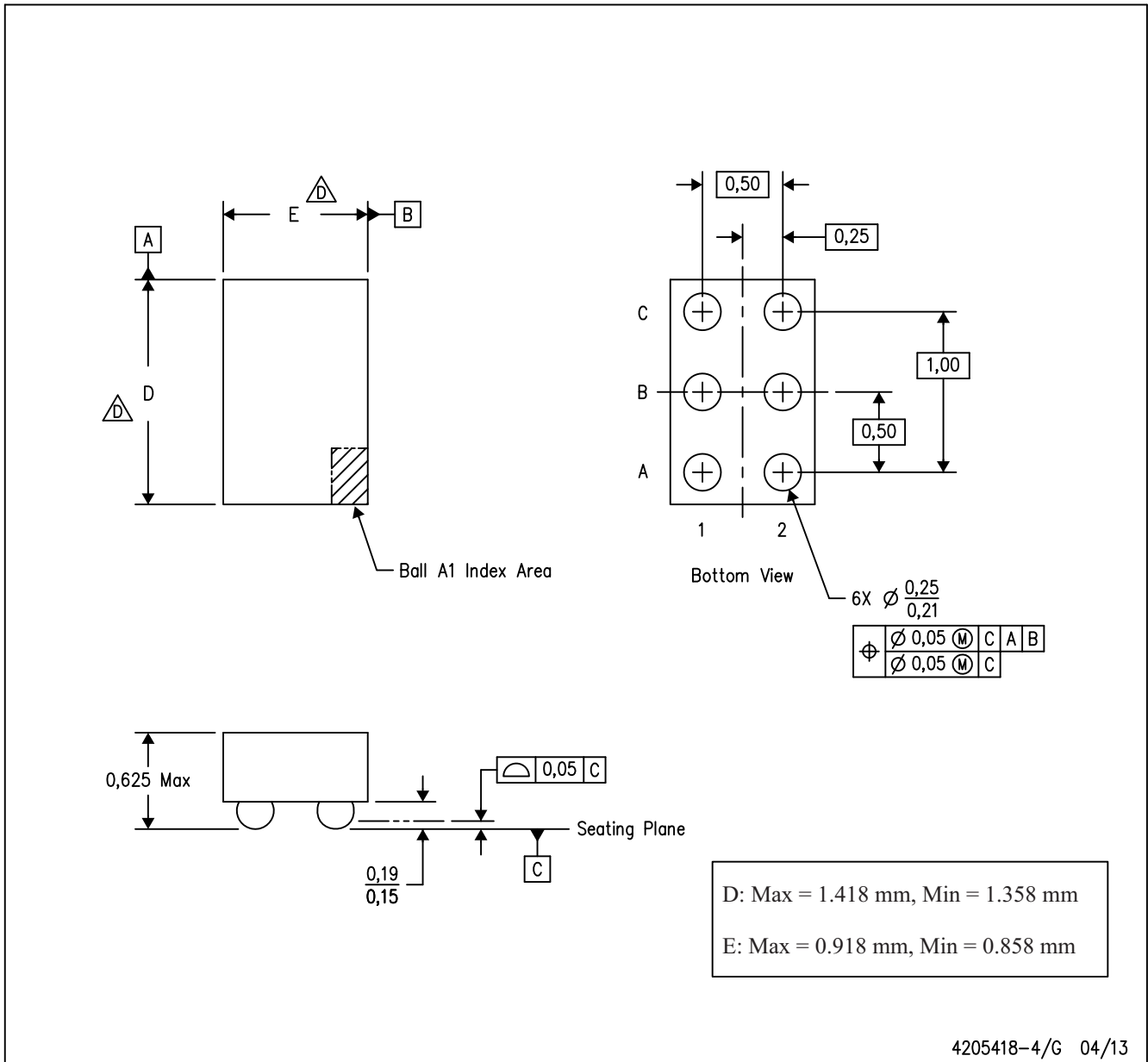
DIE-SIZE BALL GRID ARRAY



- NOTES:
- A. All linear dimensions are in millimeters.
 - B. This drawing is subject to change without notice.
 - C. NanoFree™ package configuration.
 -  The package size (Dimension D and E) of a particular device is specified in the device Product Data Sheet version of this drawing, in case it cannot be found in the product data sheet please contact a local TI representative.
 - E. Reference Product Data Sheet for array population.
2 x 3 matrix pattern is shown for illustration only.
 - F. This package contains Pb-free balls. Refer to the 4 YET package (drawing 4205421) for tin-lead (SnPb).

NanoFree is a trademark of Texas Instruments.

YFP (R-XBGA-N6)

DIE-SIZE BALL GRID ARRAY

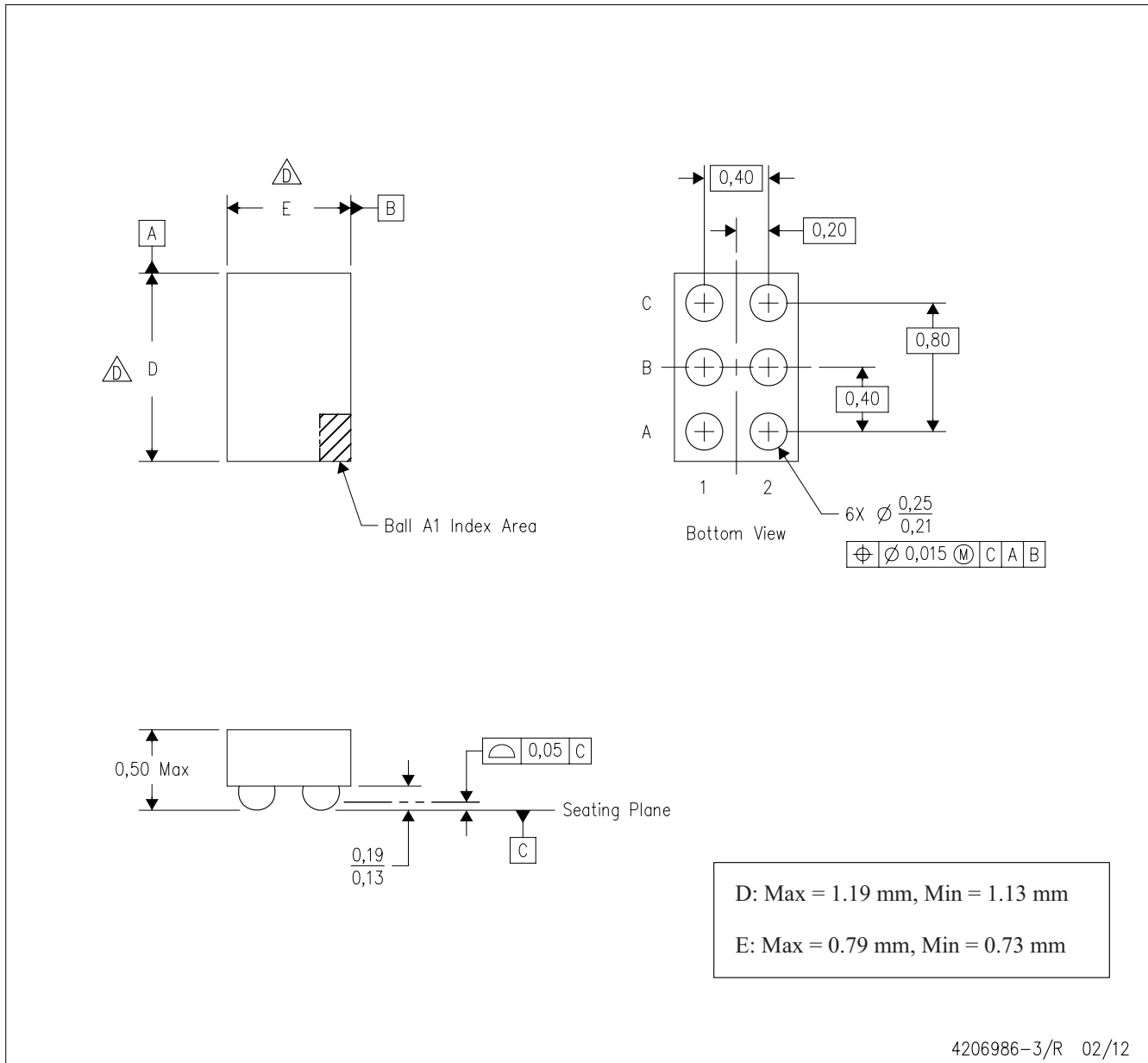

- NOTES:
- A. All linear dimensions are in millimeters. Dimensioning and tolerancing per ASME Y14.5M-1994.
 - B. This drawing is subject to change without notice.
 - C. NanoFree™ package configuration.
 - \triangle The package size (Dimension D and E) of a particular device is specified in the device Product Data Sheet version of this drawing, in case it cannot be found in the product data sheet please contact a local TI representative.
 - E. Reference Product Data Sheet for array population.
2 x 3 matrix pattern is shown for illustration only.
 - F. This package contains Pb-free balls.

NanoFree is a trademark of Texas Instruments

PACKAGING INFORMATION

Orderable Device	Status (1)	Package Type	Package Drawing	Pins	Package Qty	Eco Plan (2)	Lead/Ball Finish	MSL Peak Temp (3)	Op Temp (°C)	Top-Side Markings (4)	Samples
TPS22921YFPR	ACTIVE	DSBGA	YFP	6	3000	Green (RoHS & no Sb/Br)	SNAGCU	Level-1-260C-UNLIM	-40 to 85	(3Y ~ 3Y3)	Samples
TPS22921YZPR	ACTIVE	DSBGA	YZP	6	3000	Green (RoHS & no Sb/Br)	SNAGCU	Level-1-260C-UNLIM	-40 to 85	3Y3	Samples
TPS22921YZTR	ACTIVE	DSBGA	YZT	6	3000	Green (RoHS & no Sb/Br)	SNAGCU	Level-1-260C-UNLIM	-40 to 85	(3Y3 ~ 3Y5)	Samples
TPS22922BYFPR	ACTIVE	DSBGA	YFP	6	3000	Green (RoHS & no Sb/Br)	SNAGCU	Level-1-260C-UNLIM		3Z3	Samples
TPS22922BYZPR	ACTIVE	DSBGA	YZP	6	3000	Green (RoHS & no Sb/Br)	SNAGCU	Level-1-260C-UNLIM	-40 to 85	3Z3	Samples
TPS22922YFPR	ACTIVE	DSBGA	YFP	6	3000	Green (RoHS & no Sb/Br)	SNAGCU	Level-1-260C-UNLIM		(2Z ~ 2Z3)	Samples
TPS22922YZPR	ACTIVE	DSBGA	YZP	6	3000	Green (RoHS & no Sb/Br)	SNAGCU	Level-1-260C-UNLIM	-40 to 85	2Z3	Samples

(1) The marketing status values are defined as follows:

ACTIVE: Product device recommended for new designs.

LIFEBUY: TI has announced that the device will be discontinued, and a lifetime-buy period is in effect.

NRND: Not recommended for new designs. Device is in production to support existing customers, but TI does not recommend using this part in a new design.

PREVIEW: Device has been announced but is not in production. Samples may or may not be available.

OBSOLETE: TI has discontinued the production of the device.

(2) Eco Plan - The planned eco-friendly classification: Pb-Free (RoHS), Pb-Free (RoHS Exempt), or Green (RoHS & no Sb/Br) - please check <http://www.ti.com/productcontent> for the latest availability information and additional product content details.

TBD: The Pb-Free/Green conversion plan has not been defined.

Pb-Free (RoHS): TI's terms "Lead-Free" or "Pb-Free" mean semiconductor products that are compatible with the current RoHS requirements for all 6 substances, including the requirement that lead not exceed 0.1% by weight in homogeneous materials. Where designed to be soldered at high temperatures, TI Pb-Free products are suitable for use in specified lead-free processes.

Pb-Free (RoHS Exempt): This component has a RoHS exemption for either 1) lead-based flip-chip solder bumps used between the die and package, or 2) lead-based die adhesive used between the die and leadframe. The component is otherwise considered Pb-Free (RoHS compatible) as defined above.

Green (RoHS & no Sb/Br): TI defines "Green" to mean Pb-Free (RoHS compatible), and free of Bromine (Br) and Antimony (Sb) based flame retardants (Br or Sb do not exceed 0.1% by weight in homogeneous material)

(3) MSL, Peak Temp. -- The Moisture Sensitivity Level rating according to the JEDEC industry standard classifications, and peak solder temperature.

(4) Multiple Top-Side Markings will be inside parentheses. Only one Top-Side Marking contained in parentheses and separated by a "~" will appear on a device. If a line is indented then it is a continuation of the previous line and the two combined represent the entire Top-Side Marking for that device.

Important Information and Disclaimer: The information provided on this page represents TI's knowledge and belief as of the date that it is provided. TI bases its knowledge and belief on information provided by third parties, and makes no representation or warranty as to the accuracy of such information. Efforts are underway to better integrate information from third parties. TI has taken and continues to take reasonable steps to provide representative and accurate information but may not have conducted destructive testing or chemical analysis on incoming materials and chemicals. TI and TI suppliers consider certain information to be proprietary, and thus CAS numbers and other limited information may not be available for release.

In no event shall TI's liability arising out of such information exceed the total purchase price of the TI part(s) at issue in this document sold by TI to Customer on an annual basis.

TAPE AND REEL INFORMATION



QUADRANT ASSIGNMENTS FOR PIN 1 ORIENTATION IN TAPE



*All dimensions are nominal

Device	Package Type	Package Drawing	Pins	SPQ	Reel Diameter (mm)	Reel Width W1 (mm)	A0 (mm)	B0 (mm)	K0 (mm)	P1 (mm)	W (mm)	Pin1 Quadrant
TPS22921YFPR	DSBGA	YFP	6	3000	180.0	8.4	0.89	1.29	0.62	4.0	8.0	Q1
TPS22921YZPR	DSBGA	YZP	6	3000	180.0	8.4	1.02	1.52	0.63	4.0	8.0	Q1
TPS22921YZTR	DSBGA	YZT	6	3000	178.0	9.2	1.02	1.52	0.75	4.0	8.0	Q1
TPS22922BYFPR	DSBGA	YFP	6	3000	180.0	8.4	0.89	1.29	0.62	4.0	8.0	Q1
TPS22922BYZPR	DSBGA	YZP	6	3000	180.0	8.4	1.02	1.52	0.63	4.0	8.0	Q1
TPS22922YFPR	DSBGA	YFP	6	3000	178.0	9.2	0.89	1.29	0.62	4.0	8.0	Q1
TPS22922YFPR	DSBGA	YFP	6	3000	180.0	8.4	0.89	1.29	0.62	4.0	8.0	Q1
TPS22922YZPR	DSBGA	YZP	6	3000	180.0	8.4	1.02	1.52	0.63	4.0	8.0	Q1

TAPE AND REEL BOX DIMENSIONS

*All dimensions are nominal

Device	Package Type	Package Drawing	Pins	SPQ	Length (mm)	Width (mm)	Height (mm)
TPS22921YFPR	DSBGA	YFP	6	3000	210.0	185.0	35.0
TPS22921YZPR	DSBGA	YZP	6	3000	220.0	220.0	34.0
TPS22921YZTR	DSBGA	YZT	6	3000	220.0	220.0	35.0
TPS22922BYFPR	DSBGA	YFP	6	3000	220.0	220.0	34.0
TPS22922BYZPR	DSBGA	YZP	6	3000	220.0	220.0	34.0
TPS22922YFPR	DSBGA	YFP	6	3000	220.0	220.0	35.0
TPS22922YFPR	DSBGA	YFP	6	3000	210.0	185.0	35.0
TPS22922YZPR	DSBGA	YZP	6	3000	220.0	220.0	34.0

IMPORTANT NOTICE

Texas Instruments Incorporated and its subsidiaries (TI) reserve the right to make corrections, enhancements, improvements and other changes to its semiconductor products and services per JESD46, latest issue, and to discontinue any product or service per JESD48, latest issue. Buyers should obtain the latest relevant information before placing orders and should verify that such information is current and complete. All semiconductor products (also referred to herein as "components") are sold subject to TI's terms and conditions of sale supplied at the time of order acknowledgment.

TI warrants performance of its components to the specifications applicable at the time of sale, in accordance with the warranty in TI's terms and conditions of sale of semiconductor products. Testing and other quality control techniques are used to the extent TI deems necessary to support this warranty. Except where mandated by applicable law, testing of all parameters of each component is not necessarily performed.

TI assumes no liability for applications assistance or the design of Buyers' products. Buyers are responsible for their products and applications using TI components. To minimize the risks associated with Buyers' products and applications, Buyers should provide adequate design and operating safeguards.

TI does not warrant or represent that any license, either express or implied, is granted under any patent right, copyright, mask work right, or other intellectual property right relating to any combination, machine, or process in which TI components or services are used. Information published by TI regarding third-party products or services does not constitute a license to use such products or services or a warranty or endorsement thereof. Use of such information may require a license from a third party under the patents or other intellectual property of the third party, or a license from TI under the patents or other intellectual property of TI.

Reproduction of significant portions of TI information in TI data books or data sheets is permissible only if reproduction is without alteration and is accompanied by all associated warranties, conditions, limitations, and notices. TI is not responsible or liable for such altered documentation. Information of third parties may be subject to additional restrictions.

Resale of TI components or services with statements different from or beyond the parameters stated by TI for that component or service voids all express and any implied warranties for the associated TI component or service and is an unfair and deceptive business practice. TI is not responsible or liable for any such statements.

Buyer acknowledges and agrees that it is solely responsible for compliance with all legal, regulatory and safety-related requirements concerning its products, and any use of TI components in its applications, notwithstanding any applications-related information or support that may be provided by TI. Buyer represents and agrees that it has all the necessary expertise to create and implement safeguards which anticipate dangerous consequences of failures, monitor failures and their consequences, lessen the likelihood of failures that might cause harm and take appropriate remedial actions. Buyer will fully indemnify TI and its representatives against any damages arising out of the use of any TI components in safety-critical applications.

In some cases, TI components may be promoted specifically to facilitate safety-related applications. With such components, TI's goal is to help enable customers to design and create their own end-product solutions that meet applicable functional safety standards and requirements. Nonetheless, such components are subject to these terms.

No TI components are authorized for use in FDA Class III (or similar life-critical medical equipment) unless authorized officers of the parties have executed a special agreement specifically governing such use.

Only those TI components which TI has specifically designated as military grade or "enhanced plastic" are designed and intended for use in military/aerospace applications or environments. Buyer acknowledges and agrees that any military or aerospace use of TI components which have **not** been so designated is solely at the Buyer's risk, and that Buyer is solely responsible for compliance with all legal and regulatory requirements in connection with such use.

TI has specifically designated certain components as meeting ISO/TS16949 requirements, mainly for automotive use. In any case of use of non-designated products, TI will not be responsible for any failure to meet ISO/TS16949.

Products

Audio	www.ti.com/audio
Amplifiers	amplifier.ti.com
Data Converters	dataconverter.ti.com
DLP® Products	www.dlp.com
DSP	dsp.ti.com
Clocks and Timers	www.ti.com/clocks
Interface	interface.ti.com
Logic	logic.ti.com
Power Mgmt	power.ti.com
Microcontrollers	microcontroller.ti.com
RFID	www.ti-rfid.com
OMAP Applications Processors	www.ti.com/omap
Wireless Connectivity	www.ti.com/wirelessconnectivity

Applications

Automotive and Transportation	www.ti.com/automotive
Communications and Telecom	www.ti.com/communications
Computers and Peripherals	www.ti.com/computers
Consumer Electronics	www.ti.com/consumer-apps
Energy and Lighting	www.ti.com/energy
Industrial	www.ti.com/industrial
Medical	www.ti.com/medical
Security	www.ti.com/security
Space, Avionics and Defense	www.ti.com/space-avionics-defense
Video and Imaging	www.ti.com/video

TI E2E Community

e2e.ti.com