

2.25 MHz 400-mA Step Down Converter With Selectable VOUT

FEATURES

- High Efficiency Step Down Converter
- Output Current up to 400 mA
- V_{IN} Range From 2V to 6V for Li-Ion Batteries With Extended Voltage Range
- 2.25 MHz Fixed Frequency Operation
- Pin-Selectable Fixed Output Voltage
- Power Save Mode for Highest Efficiency
- Automatic transition between PFM and PWM Mode
- Voltage Positioning in PFM Mode
- Typical 15- μ A Quiescent Current
- 100% Duty Cycle for Lowest Dropout
- Available in 2x2x0,8 mm SON Package
- Allows <1 mm Solution Height

APPLICATIONS

- Low Power Processor Supply
- Cell Phones, Smart-phones
- Navigation Systems
- Low Power DSP Supply
- Portable Media Players
- Digital Cameras

DESCRIPTION

The TPS62270 device is a high efficiency synchronous step down DC-DC converter optimized for battery powered portable applications. It provides up to 400 mA output current from a single Li-Ion cell.

With an input voltage range of 2 V to 6 V the device supports Li-Ion batteries with extended voltage range, and is ideal to power portable applications like mobile phones and other portable equipment.

The TPS62270 operates at 2.25 MHz fixed switching frequency and enters Power Save Mode operation at light load currents to maintain high efficiency over the entire load current range. The Power Save Mode is optimized for low output voltage ripple.

With the VSEL pin, two different fixed output voltages can be selected. This function features a dynamic voltage scaling for low power processor cores.

In the shutdown mode, the current consumption is reduced to less than 1 μ A. TPS62270 allows the use of small inductors and capacitors to achieve a small solution size.

The TPS62270 is available in a 2 mm \times 2 mm, 6-pin SON package.

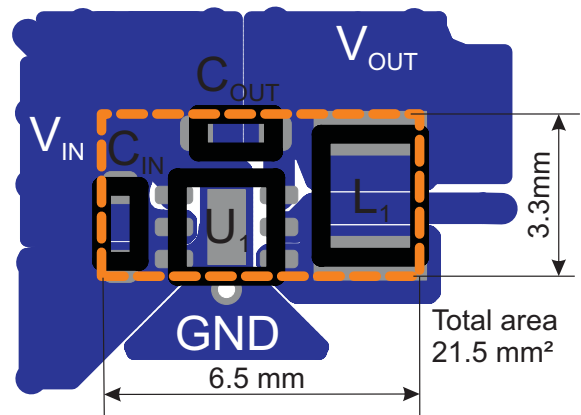
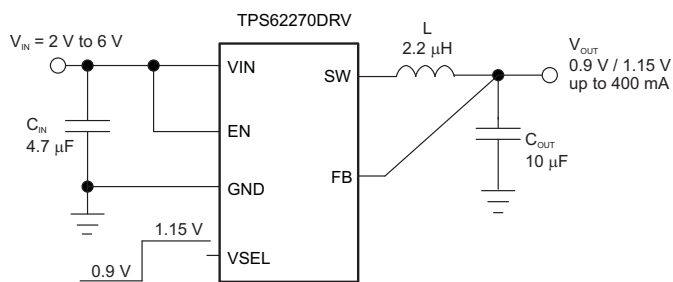

Please be aware that an important notice concerning availability, standard warranty, and use in critical applications of Texas Instruments semiconductor products and disclaimers thereto appears at the end of this data sheet.

PowerPad is a trademark of Texas Instruments.



These devices have limited built-in ESD protection. The leads should be shorted together or the device placed in conductive foam during storage or handling to prevent electrostatic damage to the MOS gates.

ORDERING INFORMATION

T _A	PART NUMBER ⁽¹⁾	OUTPUT VOLTAGE ⁽²⁾		PACKAGE DESIGNATOR	ORDERING ⁽¹⁾	PACKAGE MARKING
		VSEL = 1	VSEL = 0			
–40°C to 85°C	TPS62270	1.15 V	0.9 V	DRV	TPS62270DRV	CCX
	TPS62272	3.3V	2.1V	DRV	TPS62272DRV	OAM
	TPS62273	3.3V	2.5V	DRV	TPS62273DRV	CGW

- (1) The DRV (SON2x2) package is available in tape on reel. Add R suffix to order quantities of 3000 parts per reel, add T suffix to order quantities of 250 parts per reel.
 (2) contact TI for other fixed output voltage options.

ABSOLUTE MAXIMUM RATINGS

over operating free-air temperature range (unless otherwise noted) ⁽¹⁾

		VALUE	UNIT
	Input voltage range ⁽²⁾	–0.3 to 7	V
	Voltage range at EN, VSEL	–0.3 to VIN +0.3, ≤7	V
	Voltage on SW	–0.3 to 7	V
	Peak output current	Internally limited	A
ESD rating ⁽³⁾	HBM Human body model	2	kV
	CDM Charge device model	1	
	Machine model	200	V
T _J	Maximum operating junction temperature	–40 to 125	°C
T _{stg}	Storage temperature range	–65 to 150	°C

- (1) Stresses beyond those listed under *absolute maximum ratings* may cause permanent damage to the device. These are stress ratings only and functional operation of the device at these or any other conditions beyond those indicated under *recommended operating conditions* is not implied. Exposure to absolute–maximum–rated conditions for extended periods may affect device reliability.
 (2) All voltage values are with respect to network ground terminal.
 (3) The human body model is a 100 pF capacitor discharged through a 1.5kΩ resistor into each pin. The machine model is a 200 pF capacitor discharged directly into each pin.

DISSIPATION RATINGS

PACKAGE	R _{θJA}	POWER RATING FOR T _A ≤ 25°C	DERATING FACTOR ABOVE T _A = 25°C
DRV	76°C/W	1300 mW	13 mW/°C

RECOMMENDED OPERATING CONDITIONS

over operating free-air temperature range (unless otherwise noted)

		MIN	NOM	MAX	UNIT
V _{IN}	Supply Voltage	2		6	V
T _A	Operating ambient temperature	–40		85	°C
T _J	Operating junction temperature	–40		125	°C

ELECTRICAL CHARACTERISTICS

Over full operating ambient temperature range, typical values are at $T_A = 25^\circ\text{C}$. Unless otherwise noted, specifications apply for condition $V_{IN} = EN = 3.6\text{V}$. External components $C_{IN} = 4.7\mu\text{F}$ 0603, $C_{OUT} = 10\mu\text{F}$ 0603, $L = 2\mu\text{H}$, see the parameter measurement information.

PARAMETER		TEST CONDITIONS	MIN	TYP	MAX	UNIT		
SUPPLY								
V_{IN}	Input voltage range		2		6	V		
I_{OUT}	Output current	$2.5\text{ V} \leq V_{IN} \leq 6\text{ V}$			400	mA		
		$2\text{ V} \leq V_{IN} \leq 2.5\text{ V}$			150			
I_Q	Operating quiescent current	$I_{OUT} = 0\text{ mA}$, device not switching		15		μA		
		$I_{OUT} = 0\text{ mA}$, device switching with no load, $V_{OUT} = 1.15\text{V}$		18				
I_{SD}	Shutdown current	$EN = \text{GND}$		0.1	1	μA		
UVLO	Undervoltage lockout threshold	Falling		1.85		V		
		Rising		1.95				
ENABLE, VSEL								
V_{IH}	High level input voltage, EN, VSEL	$2\text{ V} \leq V_{IN} \leq 6\text{ V}$	1		V_{IN}	V		
V_{IL}	Low Level Input Voltage, EN, VSEL	$2\text{ V} \leq V_{IN} \leq 6\text{ V}$	0		0.4	V		
I_{IN}	Input bias Current, EN, VSEL	$EN, VSEL = \text{GND or } V_{IN}$		0.01	1.0	μA		
POWER SWITCH								
$R_{DS(on)}$	High side MOSFET on-resistance	$V_{IN} = V_{GS} = 3.6\text{V}$, $T_A = 25^\circ\text{C}$		240	480	m Ω		
	Low side MOSFET on-resistance	$V_{IN} = V_{GS} = 3.6\text{V}$, $T_A = 25^\circ\text{C}$		180	380			
I_{LIMF}	Forward current limit MOSFET high-side and low side	$V_{IN} = V_{GS} = 3.6\text{ V}$	0.56	0.7	0.84	A		
T_{SD}	Thermal shutdown	Increasing junction temperature		140		$^\circ\text{C}$		
	Thermal shutdown hysteresis	Decreasing junction temperature		20				
OSCILLATOR								
f_{SW}	Oscillator frequency	$2\text{ V} \leq V_{IN} \leq 6\text{ V}$	2	2.25	2.5	MHz		
OUTPUT								
V_{OUT}	Output voltage PWM	TPS62270	PWM operation, $2\text{ V} \leq V_{IN} \leq 6\text{ V}$, FB pin connected to $V_{OUT}^{(1)}$	VSEL = 1	1.13	1.15	1.16 7	V
				VSEL = 0	0.88 6	0.9	0.91 4	
		TPS62272	PWM operation, $2\text{ V} \leq V_{IN} \leq 6\text{ V}$, FB pin connected to $V_{OUT}^{(1)}$	VSEL = 1	3.23	3.3	3.37	
				VSEL = 0	2.06	2.1	2.14	
		TPS62273	PWM operation, FB pin connected to $V_{OUT}^{(1)}$	VSEL = 1	3.23	3.3	3.37	
				VSEL = 0	2.45	2.5	2.55	
V_{OUT}	Output voltage in PFM mode, voltage positioning	TPS62270		VSEL = 1		1.16	V	
				VSEL = 0		0.91		
		TS62272		VSEL = 1		3.34		
				VSEL = 0		2.12		
		TPS62273		VSEL = 1		3.34		
				VSEL = 0		2.53		
t_{Start}	Start-up time	Time from active EN to reach 95% of V_{OUT}		500		μs		
t_{Ramp}	V_{OUT} ramp up time	Time to ramp from 5% to 95% of V_{OUT}		250		μs		
I_{lkg}	Leakage Current into SW pin	$V_{IN} = 3.6\text{ V}$, $V_{IN} = V_{OUT} = V_{SW}$, $EN = \text{GND}^{(2)}$		0.1	1	μA		

(1) For $V_{IN} = V_{OUT} + 0.6\text{ V}$

(2) In fixed output voltage versions, the internal resistor divider network is disconnected from FB pin.

PIN ASSIGNMENTS

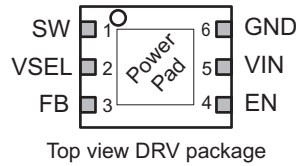

TERMINAL FUNCTIONS

TERMINAL		I/O	DESCRIPTION
NAME	NO. (SON)		
V _{IN}	5	PWR	V _{IN} power supply pin.
GND	6	PWR	GND supply pin
EN	4	I	This is the enable pin of the device. Pulling this pin to low forces the device into shutdown mode. Pulling this pin to high enables the device. This pin must be terminated.
SW	1	OUT	This is the switch pin and is connected to the internal MOSFET switches. Connect the inductor to this terminal
FB	3	I	Feedback Pin for the internal regulation loop. Connect the external resistor divider to this pin. In case of fixed output voltage option, connect this pin directly to the output capacitor
VSEL	2	I	Voltage Select input. Please refer to table ordering information for available output voltage selections.

FUNCTIONAL BLOCK DIAGRAM

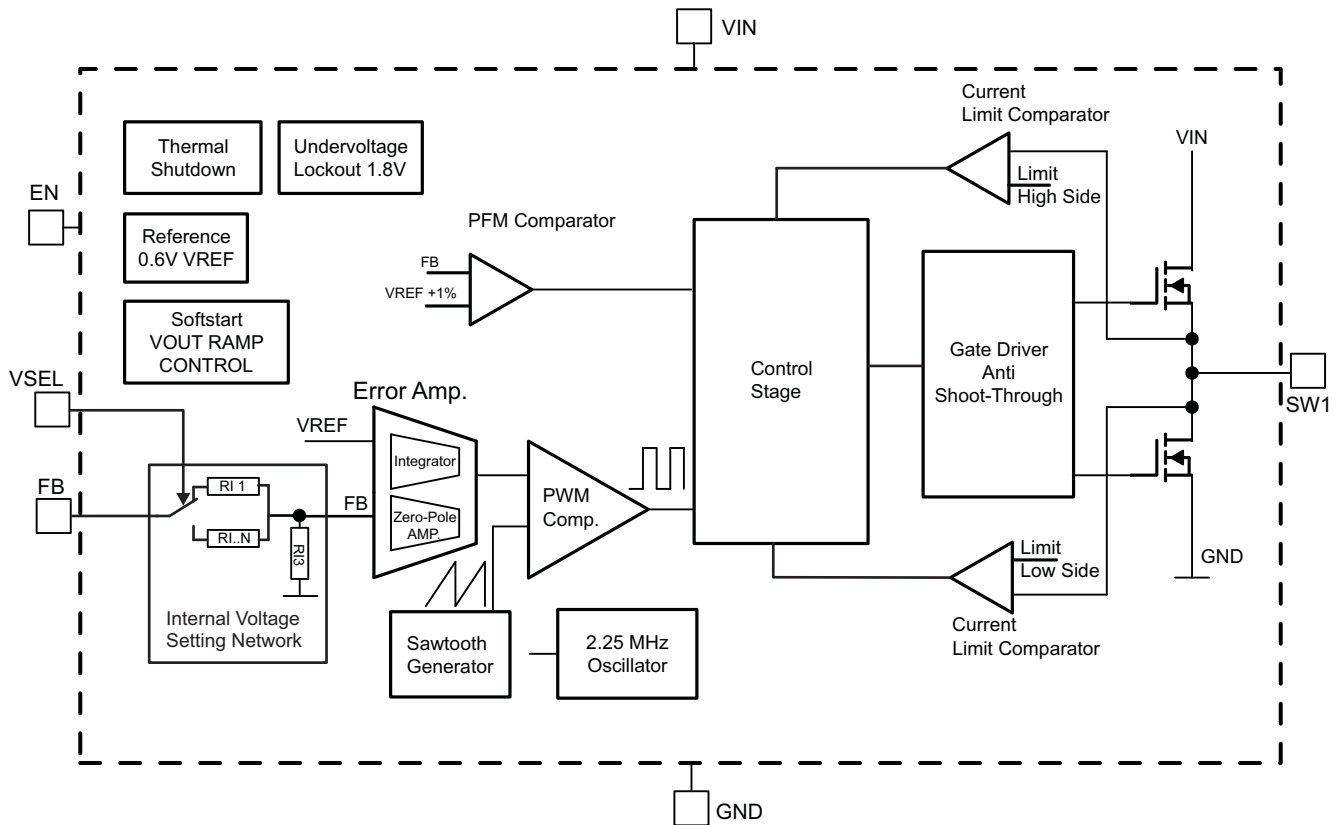

PARAMETER MEASUREMENT INFORMATION

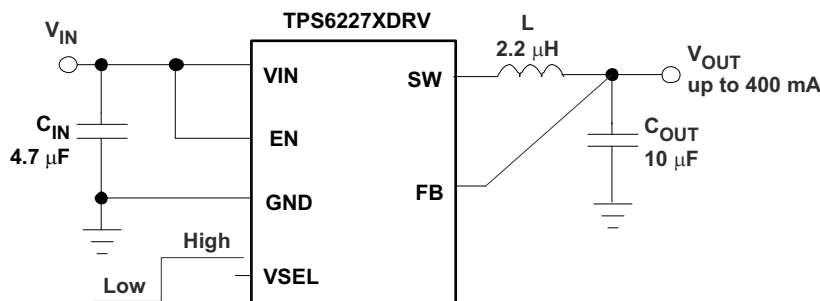

L: MIPS2520D2R2 2.0 μ H
 C_{IN} : GRM188R60J106M 4.7 μ F
 C_{OUT} : GRM188R60J106M 10 μ F

TYPICAL CHARACTERISTICS

Table of Graphs

		Figure
Efficiency	vs Output Current	Figure 1
Efficiency	vs Output Current	Figure 2
Efficiency	vs Output Current	Figure 3
Output voltage	vs Output Current	Figure 4
Output Voltage	vs Output Current	Figure 5
Output Voltage	vs Output Current	Figure 6
Output Voltage	vs Output Current	Figure 7
Output Voltage	vs Output Current	Figure 8
Output Voltage	vs Output Current	Figure 9
PWM Mode Operation		Figure 10
PFM Mode Operation		Figure 11
Load Transient Response	PFM Mode	Figure 12
Load Transient Response	PFM/PWM Mode	Figure 13
Load Transient Response	PFM/PWM Mode	Figure 14
VSEL Output Voltage Response		Figure 15
Startup in 10 Ω Load	at 1.15 V Output Voltage	Figure 16
Startup in 100 Ω Load	at 0.9 V Output Voltage	Figure 17
Startup in 220 Ω Load	at 2.1 V Output Voltage	Figure 18
Startup in 220 Ω Load	at 3.3 V Output Voltage	Figure 19
Quiescent Current	vs Input Voltage	Figure 20
Shutdown Current	vs Input Voltage	Figure 21
Static Drain Source On-state Resistance	vs Input Voltage	Figure 22
Static Drain Source On-state Resistance	vs Input Voltage	Figure 23

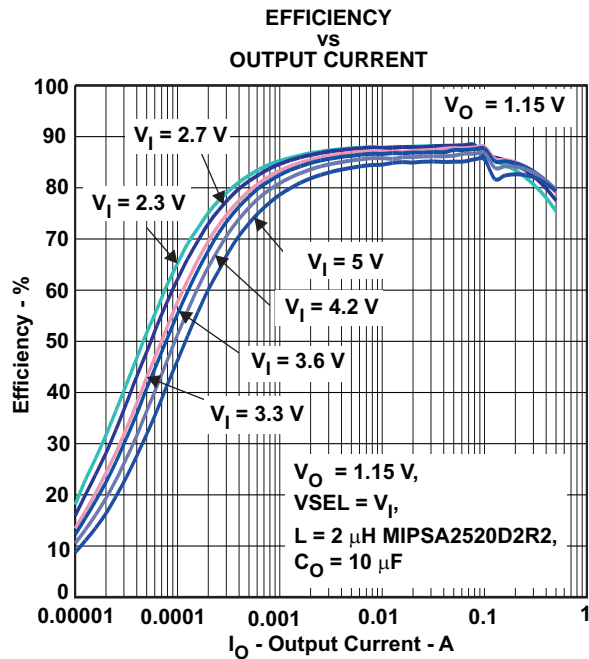

Figure 1.

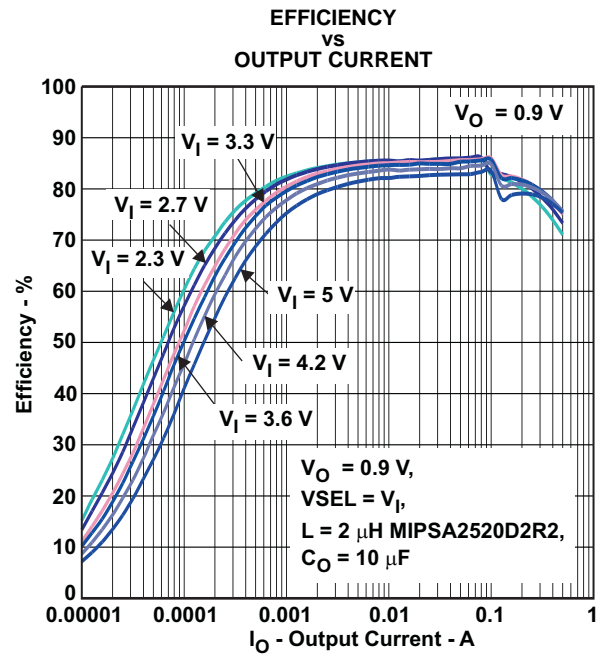

Figure 2.

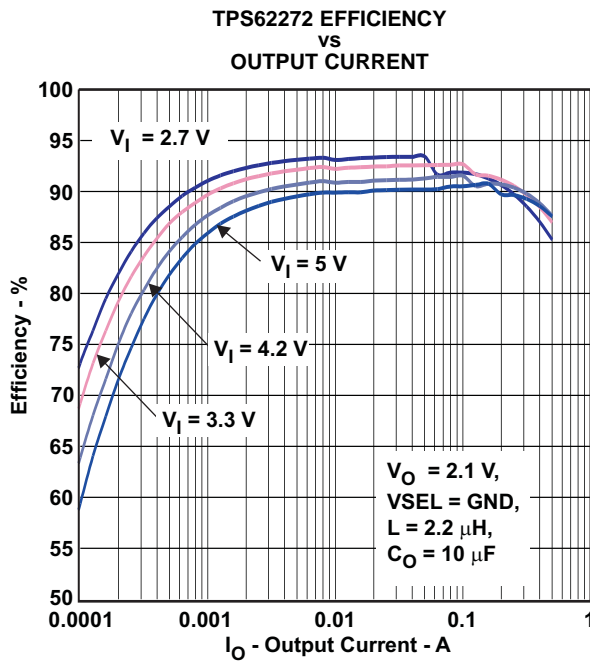

Figure 3.

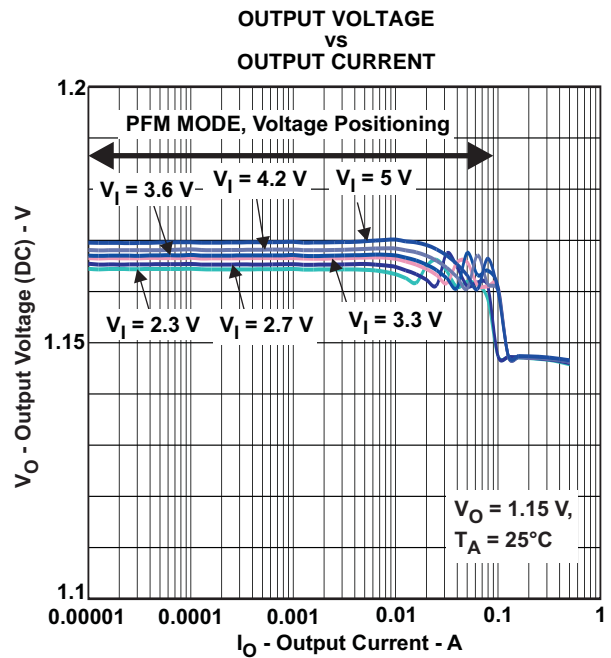

Figure 4.

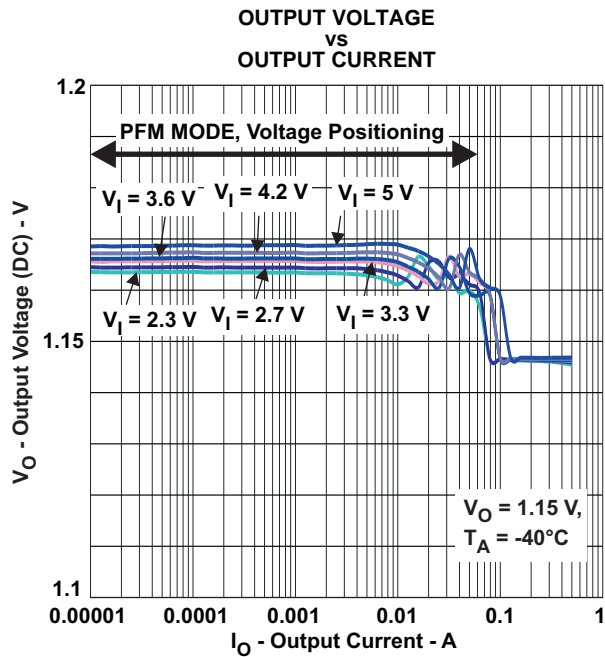

Figure 5.

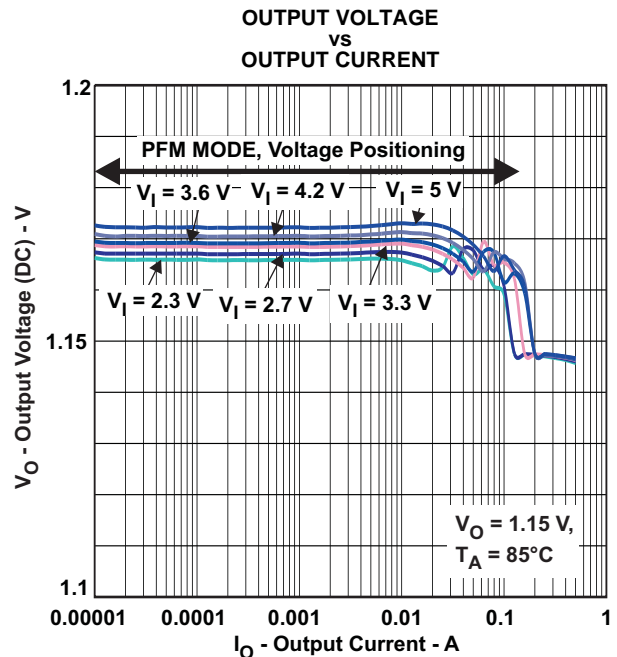

Figure 6.

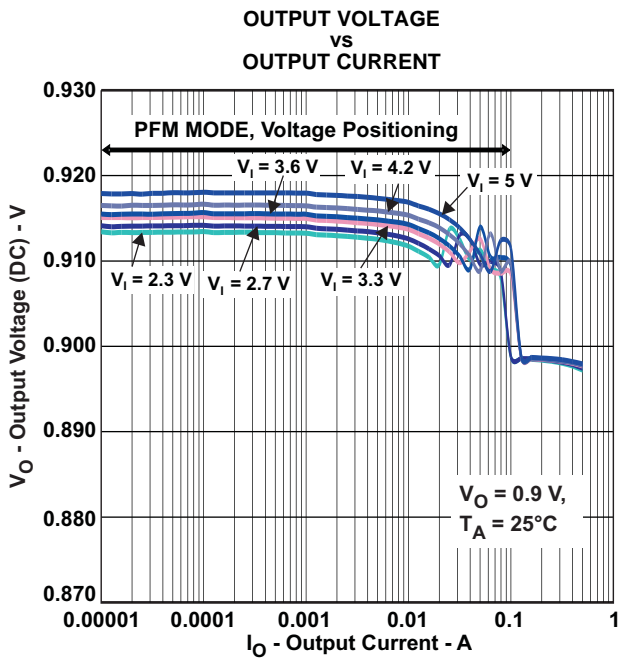

Figure 7.

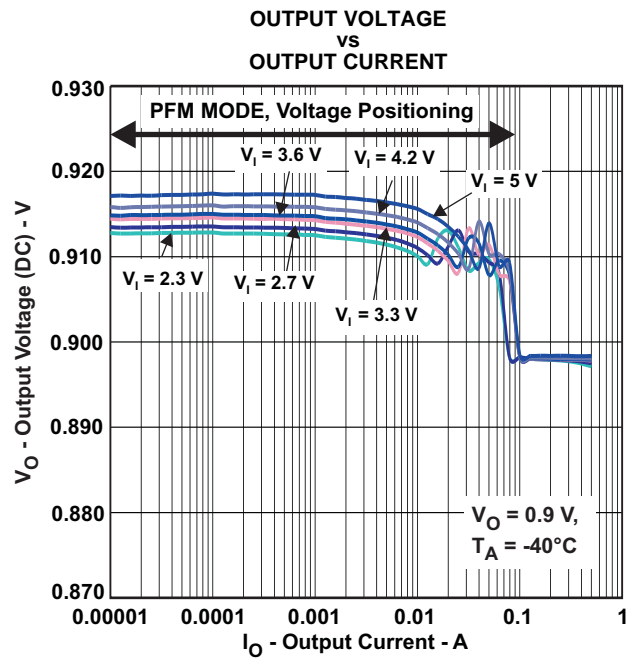

Figure 8.

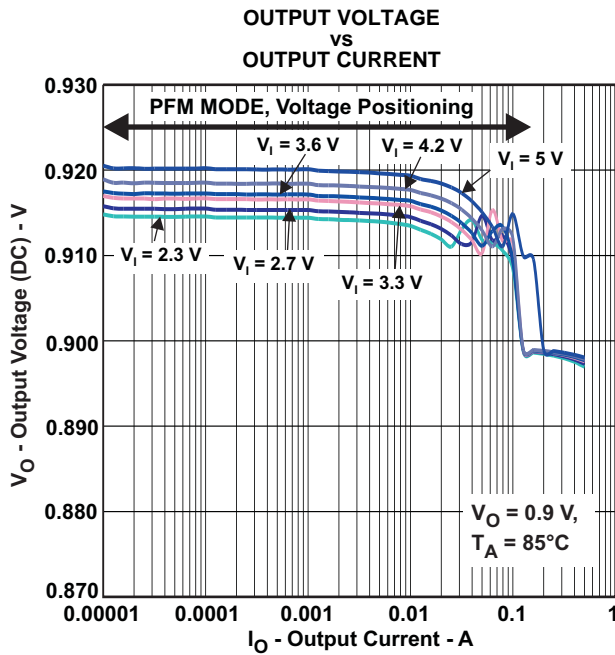

Figure 9.

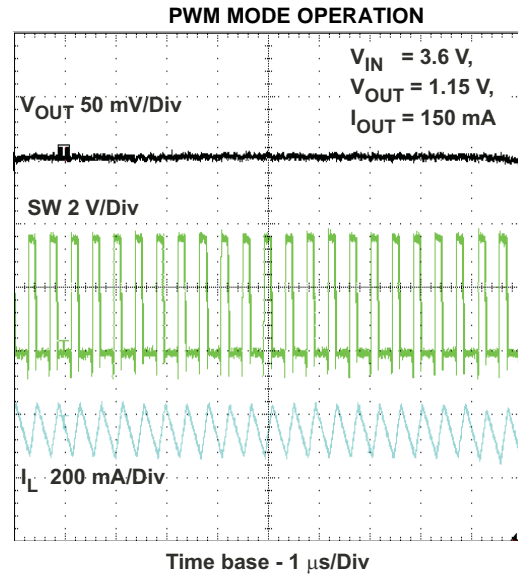

Figure 10.

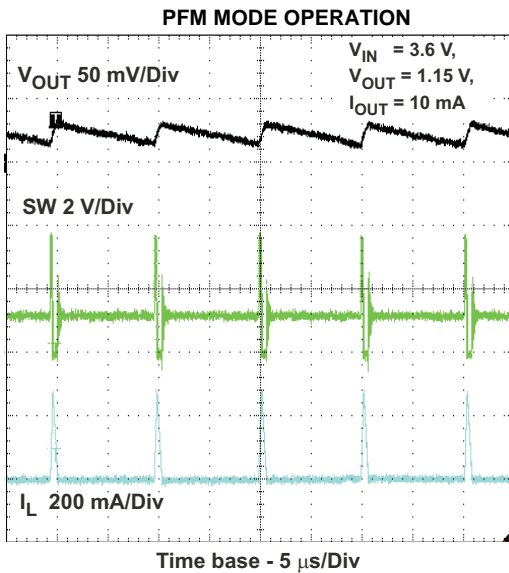

Figure 11.

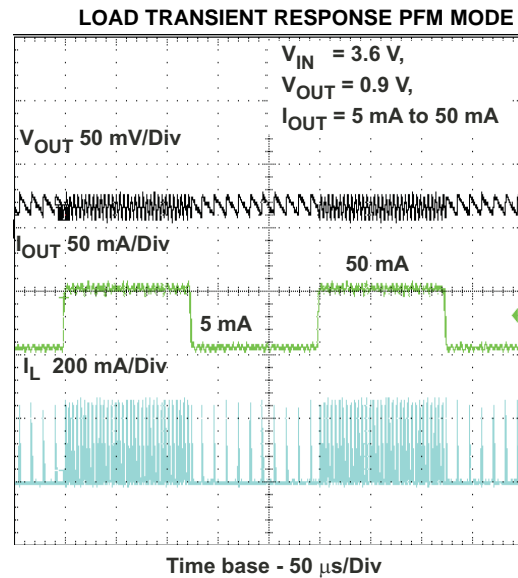
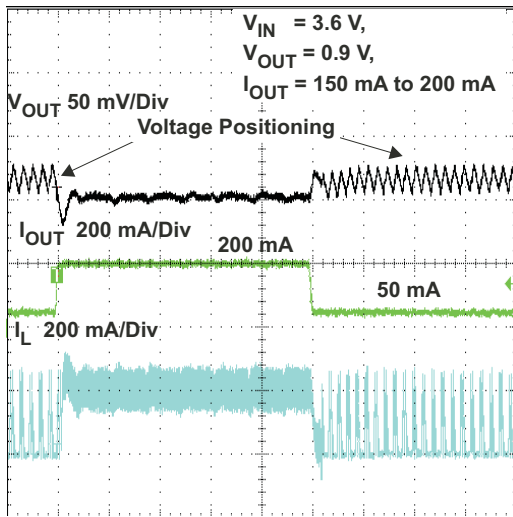

Figure 12.

LOAD TRANSIENT RESPONSE PFM/PWM MODE



Time base - 20 μ s/Div

Figure 13.

LOAD TRANSIENT RESPONSE PFM/PWM MODE

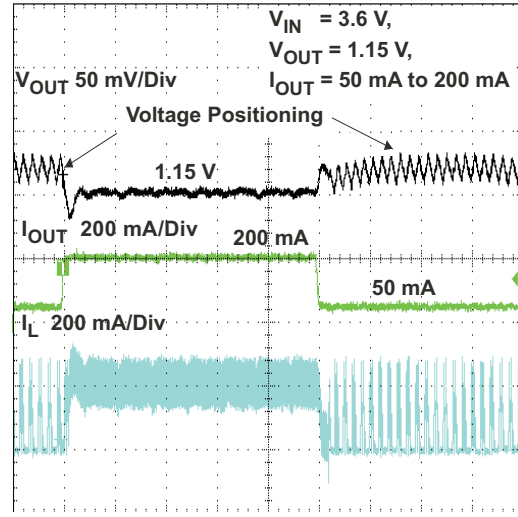

Time base - 20 μ s/Div

Figure 14.

VSEL OUTPUT VOLTAGE RESPONSE

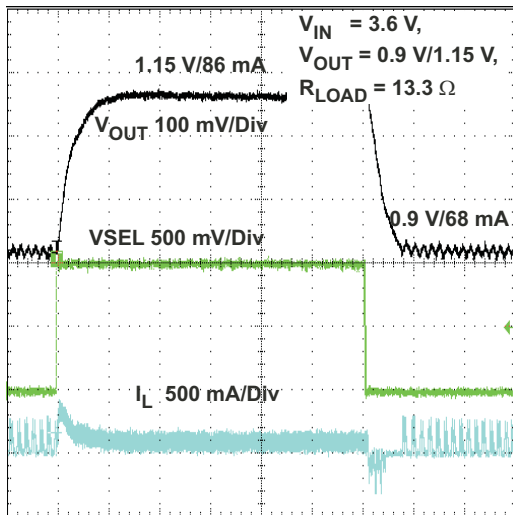

Time base - 20 μ s/Div

Figure 15.

STARTUP IN 10 Ω LOAD
AT 1.15 V OUTPUT VOLTAGE

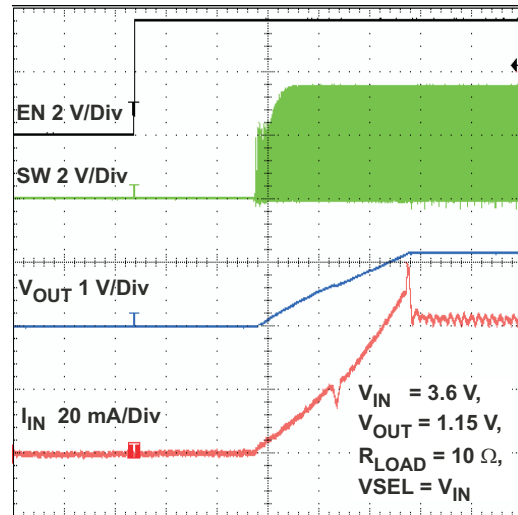

Time base - 100 μ s/Div

Figure 16.

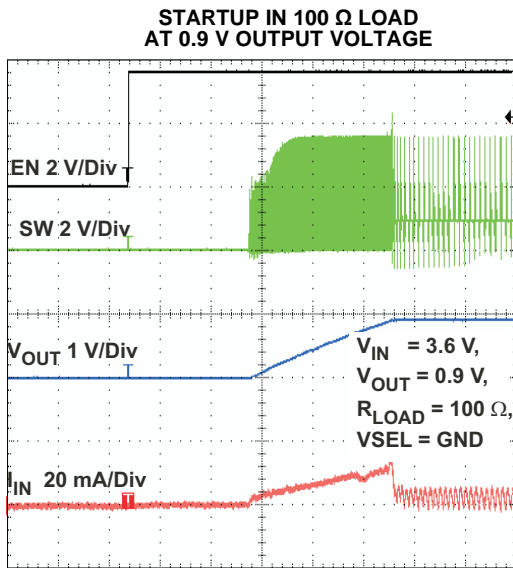

Figure 17.

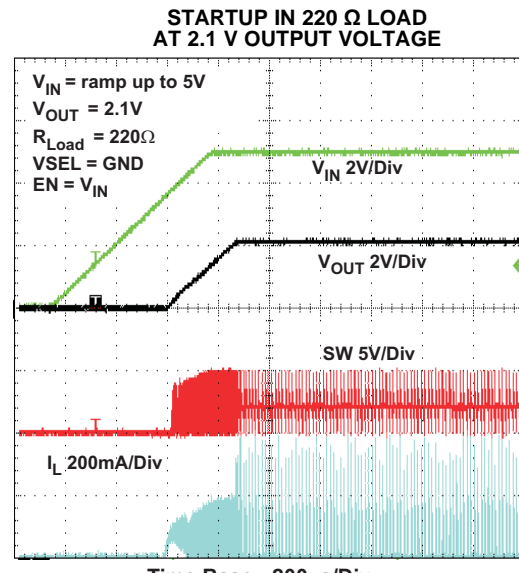

Figure 18.

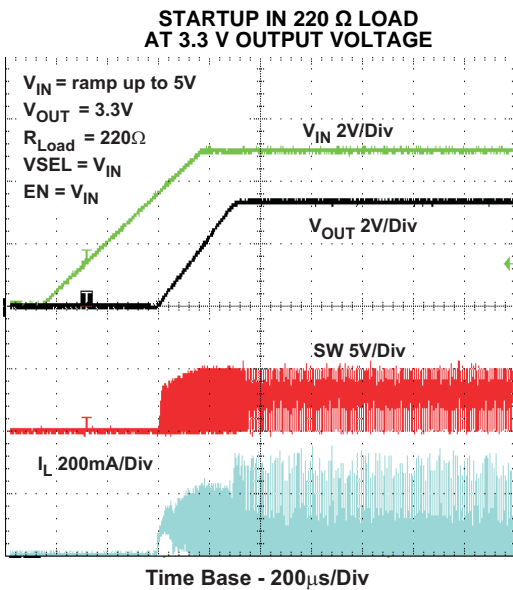
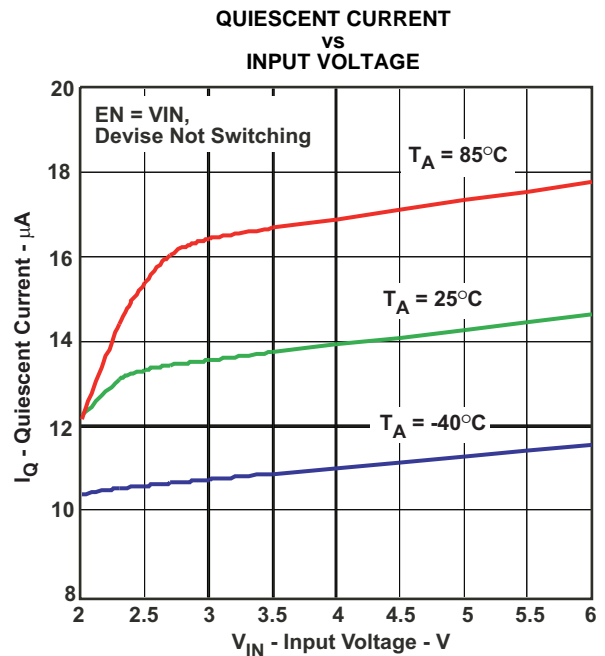

Figure 19.



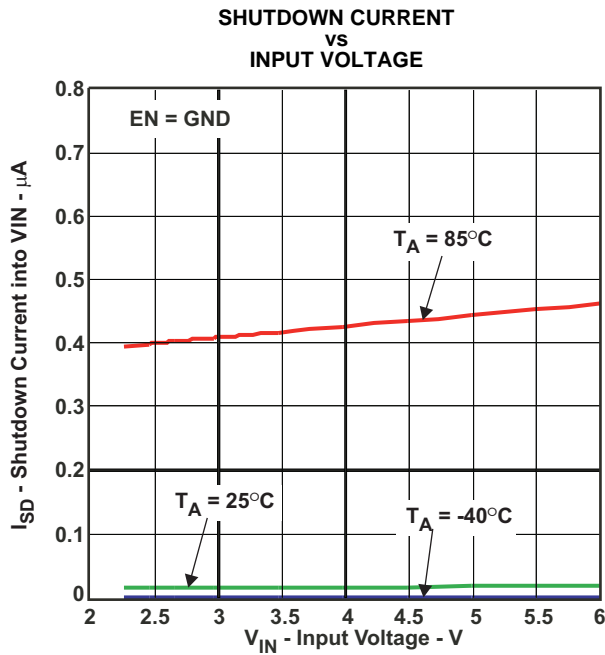

Figure 21.

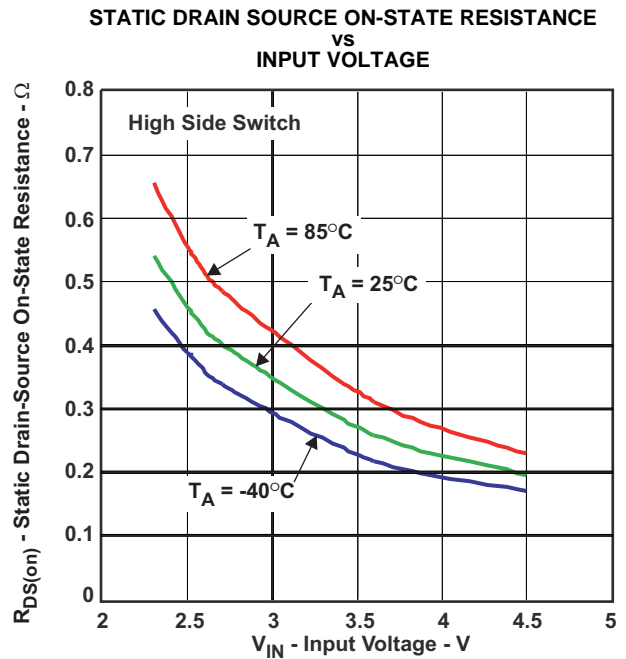

Figure 22.

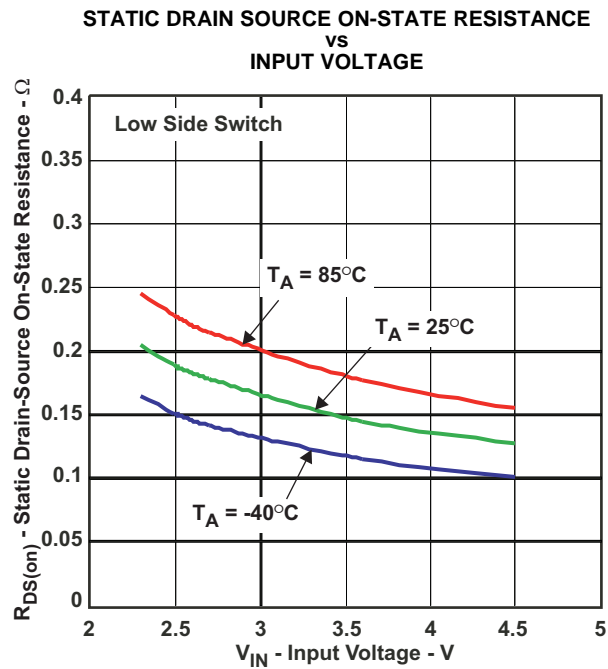

Figure 23.

DETAILED DESCRIPTION

OPERATION

The TPS62270 step down converter operates with typically 2.25 MHz fixed frequency pulse width modulation (PWM) at moderate to heavy load currents. At light load currents the converter automatically enters Power Save Mode and operates then in PFM mode.

During PWM operation the converter use a unique fast response voltage mode controller scheme with input voltage feed-forward to achieve good line and load regulation allowing the use of small ceramic input and output capacitors. At the beginning of each clock cycle initiated by the clock signal, the High Side MOSFET switch is turned on. The current flows now from the input capacitor via the High Side MOSFET switch through the inductor to the output capacitor and load. During this phase, the current ramps up until the PWM comparator trips and the control logic will turn off the switch. The current limit comparator will also turn off the switch in case the current limit of the High Side MOSFET switch is exceeded. After a dead time preventing shoot through current, the Low Side MOSFET rectifier is turned on and the inductor current will ramp down. The current flows now from the inductor to the output capacitor and to the load. It returns back to the inductor through the Low Side MOSFET rectifier.

The next cycle will be initiated by the clock signal again turning off the Low Side MOSFET rectifier and turning on the on the High Side MOSFET switch.

Power Save Mode

If the load current decreases, the converter will enter Power Save Mode operation automatically. During Power Save Mode the converter skips switching and operates with reduced frequency in PFM mode with a minimum quiescent current to maintain high efficiency.

The transition from PWM mode to PFM mode occurs once the inductor current in the Low Side MOSFET switch becomes zero, which indicates discontinuous conduction mode.

During the Power Save Mode the output voltage is monitored with a PFM comparator. As the output voltage falls below the PFM comparator threshold of $V_{OUT} + 1\%$, the device starts a PFM current pulse. For this the High Side MOSFET switch will turn on and the inductor current ramps up. After the On-time expires the switch will be turned off and the Low Side MOSFET switch will be turned on until the inductor current becomes zero.

The converter effectively delivers a current to the output capacitor and the load. If the load is below the delivered current the output voltage will rise. If the output voltage is equal or higher than the PFM comparator threshold, the device stops switching and enters a sleep mode with typical $15\mu A$ current consumption.

In case the output voltage is still below the PFM comparator threshold, further PFM current pulses will be generated until the PFM comparator threshold is reached. The converter starts switching again once the output voltage drops below the PFM comparator threshold.

With a fast single threshold comparator, the output voltage ripple during PFM mode operation can be kept very small. The PFM Pulse is timing controlled, which allows to modify the charge transferred to the output capacitor by the value of the inductor. The resulting PFM output voltage ripple depends in first order on the size of the output capacitor and the inductor value. Increasing output capacitor values and/or inductor values will minimize the output ripple.

The PFM mode is left and PWM mode entered in case the output current can not longer be supported in PFM mode.

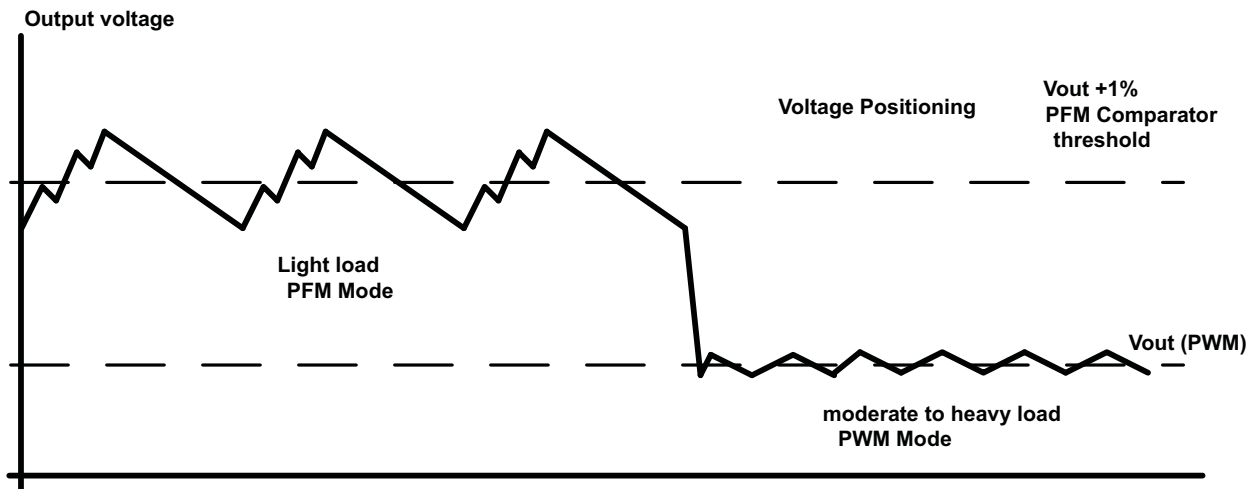

Figure 24. Power Save Mode

100% Duty Cycle Low Dropout Operation

The device starts to enter 100% duty cycle Mode once the input voltage comes close the nominal output voltage. In order to maintain the output voltage, the High Side MOSFET switch is turned on 100% for one or more cycles.

With further decreasing VIN the High Side MOSFET switch is turned on completely. In this case the converter offers a low input-to-output voltage difference. This is particularly useful in battery-powered applications to achieve longest operation time by taking full advantage of the whole battery voltage range.

The minimum input voltage to maintain regulation depends on the load current and output voltage, and can be calculated as:

$$V_{in_{min}} = V_{out_{max}} + I_{out_{max}} \times (R_{DS(on)_{max}} + R_L)$$

With

$I_{out_{max}}$ = maximum output current plus inductor ripple current

$R_{DS(on)_{max}}$ = maximum P-channel switch $R_{DS(on)}$.

R_L = DC resistance of the inductor

$V_{out_{max}}$ = nominal output voltage plus maximum output voltage tolerance

Undervoltage Lockout

The undervoltage lockout circuit prevents the device from malfunctioning at low input voltages and from excessive discharge of the battery and disables the output stage of the converter. The undervoltage lockout threshold is typically 1.85V with falling VIN.

Output Voltage Selection VSEL

The VSEL pin features output voltage selection. The output voltages are set with an internal high precision feedback divider network. No further external components for output voltage setting or compensation are required. This features smallest solution size.

Connecting the VSEL pin to an external logic control signal allows simple dynamic voltage scaling for low power processors cores. During operation of the device, the output voltage can be changed with VSEL pin.

This allows setting the core voltage of an processor according to its operating mode and helps to optimize power consumption. [Table 1](#) shows an overview of the selectable output voltages.

Table 1. VSEL Output Voltage Selection

DEVICE	OUTPUT VOLTAGE VOUT	
	VSEL = low	VSEL = high
TPS62270	0.9 V	1.15 V
TPS62272	2.1V	3.3V
TPS62273	2.5V	3.3V

Enable

The device is enabled setting EN pin to high. During the start up time $t_{\text{Start up}}$ the internal circuits are settled. Afterwards the device activates the soft start circuit. The EN input can be used to control power sequencing in a system with various DC/DC converters. The EN pin can be connected to the output of another converter, to drive the EN pin high and getting a sequencing of supply rails.

Soft Start

The TPS62270 has an internal soft start circuit that controls the ramp up of the output voltage. The output voltage ramps up from 5% to 95% of its nominal value within typ. 250 μ s. This limits the inrush current in the converter during start up and prevents possible input voltage drops when a battery or high impedance power source is used. The Soft start circuit is enabled after the start up time $t_{\text{Start up}}$ has expired.

Short-Circuit Protection

The High Side and Low Side MOSFET switches are short-circuit protected with maximum output current = I_{LIMF} . Once the High Side MOSFET switch reaches its current limit, it is turned off and the Low Side MOSFET switch is turned on. The High Side MOSFET switch can only turn on again, once the current in the Low Side MOSFET switch decreases below its current limit.

Thermal Shutdown

As soon as the junction temperature, T_J , exceeds 150°C (typical) the device goes into thermal shutdown. In this mode, the High Side and Low Side MOSFETs are turned-off. The device continues its operation when the junction temperature falls below the thermal shutdown hysteresis.

APPLICATION INFORMATION

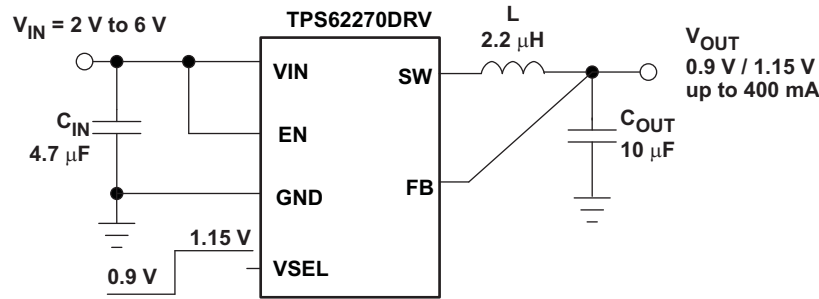

Figure 25. TPS62270DRV Application Circuit

OUTPUT FILTER DESIGN (INDUCTOR AND OUTPUT CAPACITOR)

The TPS62270 is designed to operate with inductors in the range of 1.5µH to 4.7µH and with output capacitors in the range of 4.7µF to 22µF. The part is optimized for operation with a 2.2µH inductor and 10µF output capacitor. Larger or smaller inductor values can be used to optimize the performance of the device for specific operation conditions. For stable operation, the L and C values of the output filter may not fall below 1µH effective inductance and 3.5µF effective capacitance.

Inductor Selection

The inductor value has a direct effect on the ripple current. The selected inductor has to be rated for its dc resistance and saturation current. The inductor ripple current (ΔI_L) decreases with higher inductance and increases with higher V_I or V_O .

The inductor selection has also impact on the output voltage ripple in PFM mode. Higher inductor values will lead to lower output voltage ripple and higher PFM frequency, lower inductor values will lead to a higher output voltage ripple but lower PFM frequency.

[Equation 1](#) calculates the maximum inductor current under static load conditions. The saturation current of the inductor should be rated higher than the maximum inductor current as calculated with [Equation 2](#). This is recommended because during heavy load transient the inductor current will rise above the calculated value.

$$\Delta I_L = V_{out} \times \frac{1 - \frac{V_{out}}{V_{in}}}{L \times f} \quad (1)$$

$$I_{Lmax} = I_{outmax} + \frac{\Delta I_L}{2} \quad (2)$$

With:

f = Switching Frequency (2.25 MHz typical)

L = Inductor Value

ΔI_L = Peak to Peak inductor ripple current

I_{Lmax} = Maximum Inductor current

A more conservative approach is to select the inductor current rating just for the maximum switch current of the corresponding converter.

Accepting larger values of ripple current allows the use of low inductance values, but results in higher output voltage ripple, greater core losses, and lower output current capability.

The total losses of the coil have a strong impact on the efficiency of the DC/DC conversion and consist of both the losses in the dc resistance ($R_{(DC)}$) and the following frequency-dependent components:

- The losses in the core material (magnetic hysteresis loss, especially at high switching frequencies)
- Additional losses in the conductor from the skin effect (current displacement at high frequencies)
- Magnetic field losses of the neighboring windings (proximity effect)
- Radiation losses

Table 2. List of Inductors

DIMENSIONS [mm ³]	INDUCTOR TYPE	SUPPLIER
2.5 × 2.0 × 1.0	MIPS2520	FDK
2.5 × 2.0 × 1.2	MIPSA2520	FDK
2.5 × 2.0 × 1.0	KSLI-252010AG2R2	Hitachi Metals
2.5 × 2.0 × 1.2	LQM2HPN2R2MJ0L	Murata

Output Capacitor Selection

The advanced fast-response voltage mode control scheme of the TPS62270 allows the use of tiny ceramic capacitors. Ceramic capacitors with low ESR values have the lowest output voltage ripple and are recommended. The output capacitor requires either an X7R or X5R dielectric. Y5V and Z5U dielectric capacitors, aside from their wide variation in capacitance over temperature, become resistive at high frequencies.

At nominal load current, the device operates in PWM mode and the RMS ripple current is calculated as:

$$I_{\text{RMS}C_{\text{out}}} = V_{\text{out}} \times \frac{1 - \frac{V_{\text{out}}}{V_{\text{in}}}}{L \times f} \times \frac{1}{2 \times \sqrt{3}} \quad (3)$$

At nominal load current, the device operates in PWM mode and the overall output voltage ripple is the sum of the voltage spike caused by the output capacitor ESR plus the voltage ripple caused by charging and discharging the output capacitor:

$$\Delta V_{\text{out}} = V_{\text{out}} \times \frac{1 - \frac{V_{\text{out}}}{V_{\text{in}}}}{L \times f} \times \left(\frac{1}{8 \times C_{\text{out}} \times f} + \text{ESR} \right) \quad (4)$$

At light load currents the converter operates in Power Save Mode and the output voltage ripple is dependent on the output capacitor and inductor value. Larger output capacitor and inductor values minimize the voltage ripple in PFM mode and tighten DC output accuracy in PFM mode.

Input Capacitor Selection

An input capacitor is required for best input voltage filtering, and minimizing the interference with other circuits caused by high input voltage spikes. For most applications, a 4.7µF to 10µF ceramic capacitor is recommended. Because ceramic capacitor loses up to 80% of its initial capacitance at 5 V, it is recommended that 10µF input capacitors be used for input voltages >4.5V. The input capacitor can be increased without any limit for better input voltage filtering. Take care when using only small ceramic input capacitors. When a ceramic capacitor is used at the input and the power is being supplied through long wires, such as from a wall adapter, a load step at the output or VIN step on the input can induce ringing at the VIN pin. This ringing can couple to the output and be mistaken as loop instability or could even damage the part by exceeding the maximum ratings.

Table 3. List of Capacitors

CAPACITANCE	TYPE	SIZE mm ³	SUPPLIER
4.7 µF	GRM188R60J475K	0603: 1.6 × 0.8 × 0.8 mm ³	Murata
10 µF	GRM188R60J106M69D	0603: 1.6 × 0.8 × 0.8 mm ³	Murata

LAYOUT CONSIDERATIONS

As for all switching power supplies, the layout is an important step in the design. Proper function of the device demands careful attention to PCB layout. Care must be taken in board layout to get the specified performance. If the layout is not carefully done, the regulator could show poor line and/or load regulation, stability issues as well as EMI problems. It is critical to provide a low inductance, impedance ground path. Therefore, use wide and short traces for the main current paths. The input capacitor should be placed as close as possible to the IC pins as well as the inductor and output capacitor.

Connect the GND Pin of the device to the PowerPad™ of the PCB and use this pad as a star point. Use a common Power GND node and a different node for the Signal GND to minimize the effects of ground noise. Connect these ground nodes together to the PowerPad™ (star point) underneath the IC. Keep the common path to the GND PIN, which returns the small signal components and the high current of the output capacitors as short as possible to avoid ground noise. The FB line should be connected right to the output capacitor and routed away from noisy components and traces (e.g., SW line).

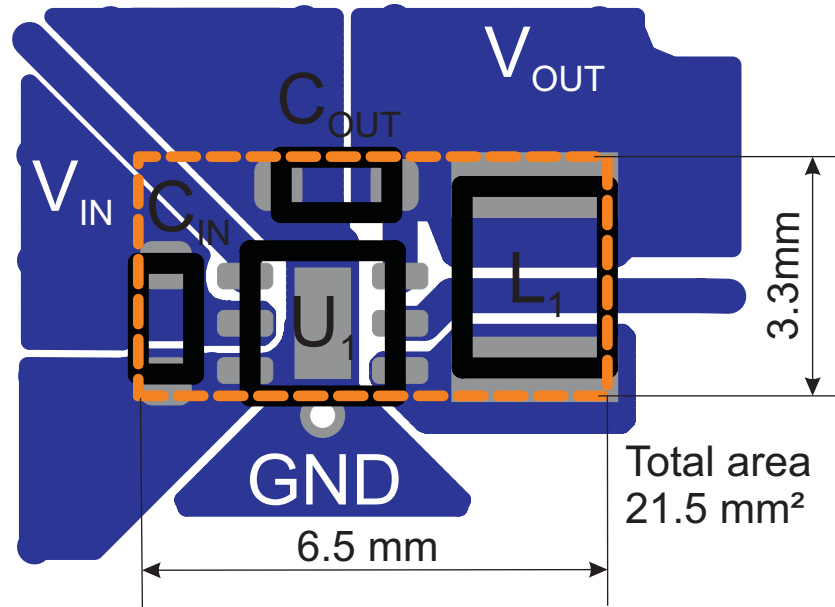

Figure 26. Suggested Board Layout

PACKAGING INFORMATION

Orderable Device	Status (1)	Package Type	Package Drawing	Pins	Package Qty	Eco Plan (2)	Lead/Ball Finish	MSL Peak Temp (3)	Op Temp (°C)	Top-Side Markings (4)	Samples
TPS62270DRVR	ACTIVE	SON	DRV	6	3000	Green (RoHS & no Sb/Br)	CU NIPDAU	Level-1-260C-UNLIM	-40 to 85	CCX	Samples
TPS62270DRVRG4	ACTIVE	SON	DRV	6	3000	Green (RoHS & no Sb/Br)	CU NIPDAU	Level-1-260C-UNLIM	-40 to 85	CCX	Samples
TPS62270DRVT	ACTIVE	SON	DRV	6	250	Green (RoHS & no Sb/Br)	CU NIPDAU	Level-1-260C-UNLIM	-40 to 85	CCX	Samples
TPS62270DRVTG4	ACTIVE	SON	DRV	6	250	Green (RoHS & no Sb/Br)	CU NIPDAU	Level-1-260C-UNLIM	-40 to 85	CCX	Samples
TPS62272DRVR	ACTIVE	SON	DRV	6	3000	Green (RoHS & no Sb/Br)	CU NIPDAU	Level-1-260C-UNLIM	-40 to 85	OAM	Samples
TPS62272DRVT	ACTIVE	SON	DRV	6	250	Green (RoHS & no Sb/Br)	CU NIPDAU	Level-1-260C-UNLIM	-40 to 85	OAM	Samples
TPS62273DRVR	ACTIVE	SON	DRV	6	3000	Green (RoHS & no Sb/Br)	CU NIPDAU	Level-1-260C-UNLIM	-40 to 85	CGW	Samples
TPS62273DRVRG4	ACTIVE	SON	DRV	6	3000	Green (RoHS & no Sb/Br)	CU NIPDAU	Level-1-260C-UNLIM	-40 to 85	CGW	Samples
TPS62273DRVT	ACTIVE	SON	DRV	6	250	Green (RoHS & no Sb/Br)	CU NIPDAU	Level-1-260C-UNLIM	-40 to 85	CGW	Samples
TPS62273DRVTG4	ACTIVE	SON	DRV	6	250	Green (RoHS & no Sb/Br)	CU NIPDAU	Level-1-260C-UNLIM	-40 to 85	CGW	Samples

(1) The marketing status values are defined as follows:

ACTIVE: Product device recommended for new designs.

LIFEBUY: TI has announced that the device will be discontinued, and a lifetime-buy period is in effect.

NRND: Not recommended for new designs. Device is in production to support existing customers, but TI does not recommend using this part in a new design.

PREVIEW: Device has been announced but is not in production. Samples may or may not be available.

OBSOLETE: TI has discontinued the production of the device.

(2) Eco Plan - The planned eco-friendly classification: Pb-Free (RoHS), Pb-Free (RoHS Exempt), or Green (RoHS & no Sb/Br) - please check <http://www.ti.com/productcontent> for the latest availability information and additional product content details.

TBD: The Pb-Free/Green conversion plan has not been defined.

Pb-Free (RoHS): TI's terms "Lead-Free" or "Pb-Free" mean semiconductor products that are compatible with the current RoHS requirements for all 6 substances, including the requirement that lead not exceed 0.1% by weight in homogeneous materials. Where designed to be soldered at high temperatures, TI Pb-Free products are suitable for use in specified lead-free processes.

Pb-Free (RoHS Exempt): This component has a RoHS exemption for either 1) lead-based flip-chip solder bumps used between the die and package, or 2) lead-based die adhesive used between the die and leadframe. The component is otherwise considered Pb-Free (RoHS compatible) as defined above.

Green (RoHS & no Sb/Br): TI defines "Green" to mean Pb-Free (RoHS compatible), and free of Bromine (Br) and Antimony (Sb) based flame retardants (Br or Sb do not exceed 0.1% by weight in homogeneous material)

⁽³⁾ MSL, Peak Temp. -- The Moisture Sensitivity Level rating according to the JEDEC industry standard classifications, and peak solder temperature.

⁽⁴⁾ Only one of markings shown within the brackets will appear on the physical device.

Important Information and Disclaimer: The information provided on this page represents TI's knowledge and belief as of the date that it is provided. TI bases its knowledge and belief on information provided by third parties, and makes no representation or warranty as to the accuracy of such information. Efforts are underway to better integrate information from third parties. TI has taken and continues to take reasonable steps to provide representative and accurate information but may not have conducted destructive testing or chemical analysis on incoming materials and chemicals. TI and TI suppliers consider certain information to be proprietary, and thus CAS numbers and other limited information may not be available for release.

In no event shall TI's liability arising out of such information exceed the total purchase price of the TI part(s) at issue in this document sold by TI to Customer on an annual basis.

TAPE AND REEL INFORMATION

QUADRANT ASSIGNMENTS FOR PIN 1 ORIENTATION IN TAPE

*All dimensions are nominal

Device	Package Type	Package Drawing	Pins	SPQ	Reel Diameter (mm)	Reel Width W1 (mm)	A0 (mm)	B0 (mm)	K0 (mm)	P1 (mm)	W (mm)	Pin1 Quadrant
TPS62270DRVR	SON	DRV	6	3000	179.0	8.4	2.2	2.2	1.2	4.0	8.0	Q2
TPS62270DRVT	SON	DRV	6	250	179.0	8.4	2.2	2.2	1.2	4.0	8.0	Q2
TPS62272DRVR	SON	DRV	6	3000	179.0	8.4	2.2	2.2	1.2	4.0	8.0	Q2
TPS62272DRVT	SON	DRV	6	250	179.0	8.4	2.2	2.2	1.2	4.0	8.0	Q2
TPS62273DRVR	SON	DRV	6	3000	179.0	8.4	2.2	2.2	1.2	4.0	8.0	Q2
TPS62273DRVT	SON	DRV	6	250	179.0	8.4	2.2	2.2	1.2	4.0	8.0	Q2

TAPE AND REEL BOX DIMENSIONS



*All dimensions are nominal

Device	Package Type	Package Drawing	Pins	SPQ	Length (mm)	Width (mm)	Height (mm)
TPS62270DRVR	SON	DRV	6	3000	203.0	203.0	35.0
TPS62270DRVT	SON	DRV	6	250	203.0	203.0	35.0
TPS62272DRVR	SON	DRV	6	3000	203.0	203.0	35.0
TPS62272DRVT	SON	DRV	6	250	203.0	203.0	35.0
TPS62273DRVR	SON	DRV	6	3000	203.0	203.0	35.0
TPS62273DRVT	SON	DRV	6	250	203.0	203.0	35.0

MECHANICAL DATA

DRV (S-PWSON-N6)

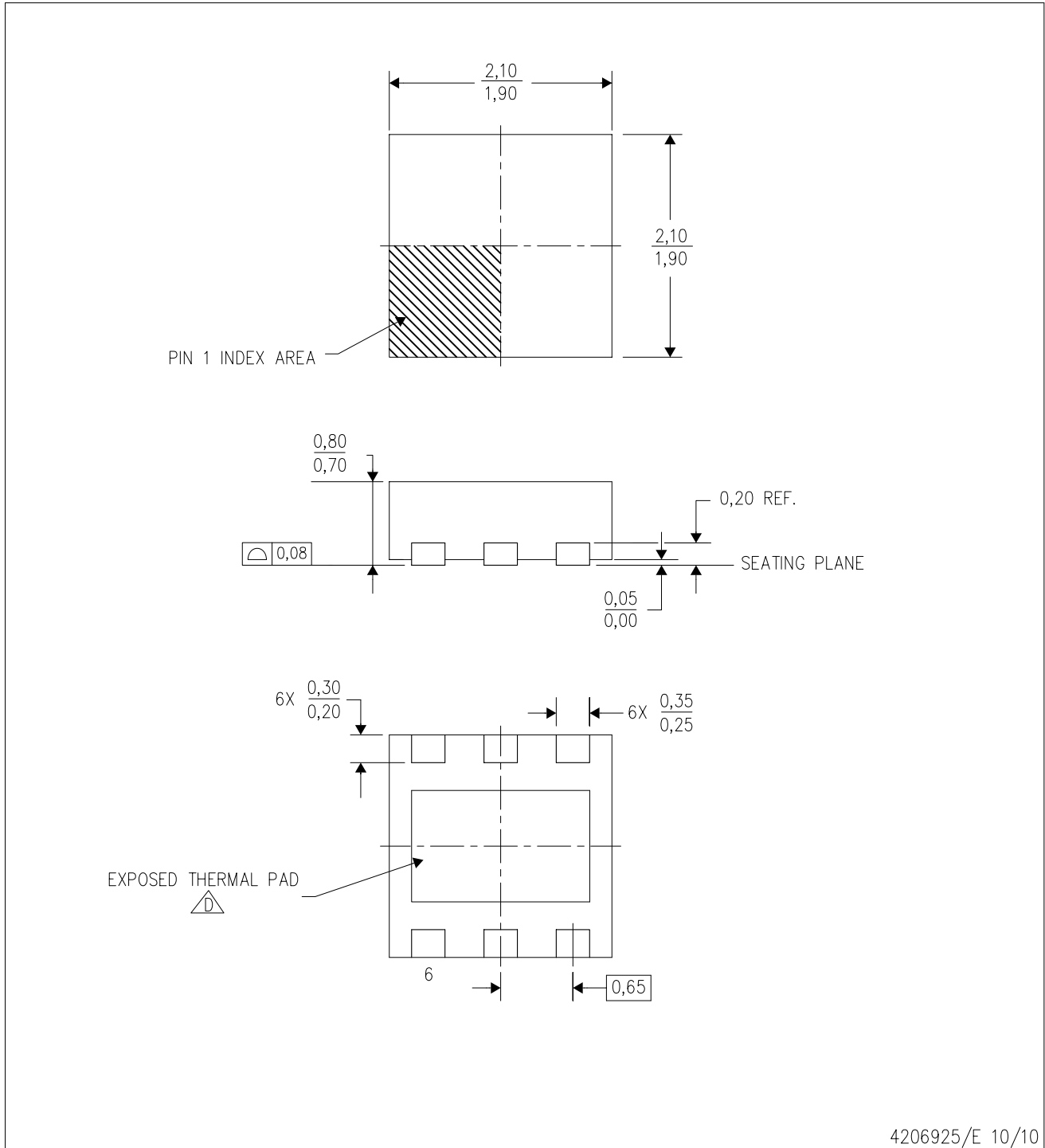
PLASTIC SMALL OUTLINE NO-LEAD



4206925/E 10/10

- NOTES:
- All linear dimensions are in millimeters. Dimensioning and tolerancing per ASME Y14.5M-1994.
 - This drawing is subject to change without notice.
 - Small Outline No-Lead (SON) package configuration.
-  The package thermal pad must be soldered to the board for thermal and mechanical performance. See the Product Data Sheet for details regarding the exposed thermal pad dimensions.

THERMAL PAD MECHANICAL DATA

DRV (S-PWSON-N6)

PLASTIC SMALL OUTLINE NO-LEAD

THERMAL INFORMATION

This package incorporates an exposed thermal pad that is designed to be attached directly to an external heatsink. The thermal pad must be soldered directly to the printed circuit board (PCB). After soldering, the PCB can be used as a heatsink. In addition, through the use of thermal vias, the thermal pad can be attached directly to the appropriate copper plane shown in the electrical schematic for the device, or alternatively, can be attached to a special heatsink structure designed into the PCB. This design optimizes the heat transfer from the integrated circuit (IC).

For information on the Quad Flatpack No-Lead (QFN) package and its advantages, refer to Application Report, QFN/SON PCB Attachment, Texas Instruments Literature No. SLUA271. This document is available at www.ti.com.

The exposed thermal pad dimensions for this package are shown in the following illustration.

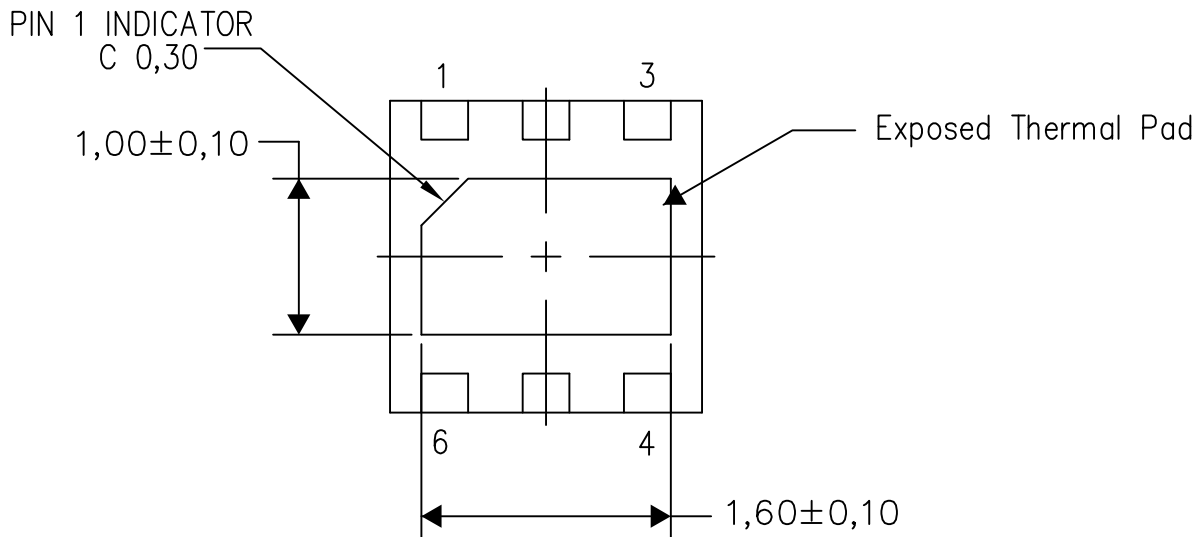

Bottom View

Exposed Thermal Pad Dimensions

4206926/N 03/13

NOTE: All linear dimensions are in millimeters

DRV (S-PWSON-N6)

PLASTIC SMALL OUTLINE NO-LEAD

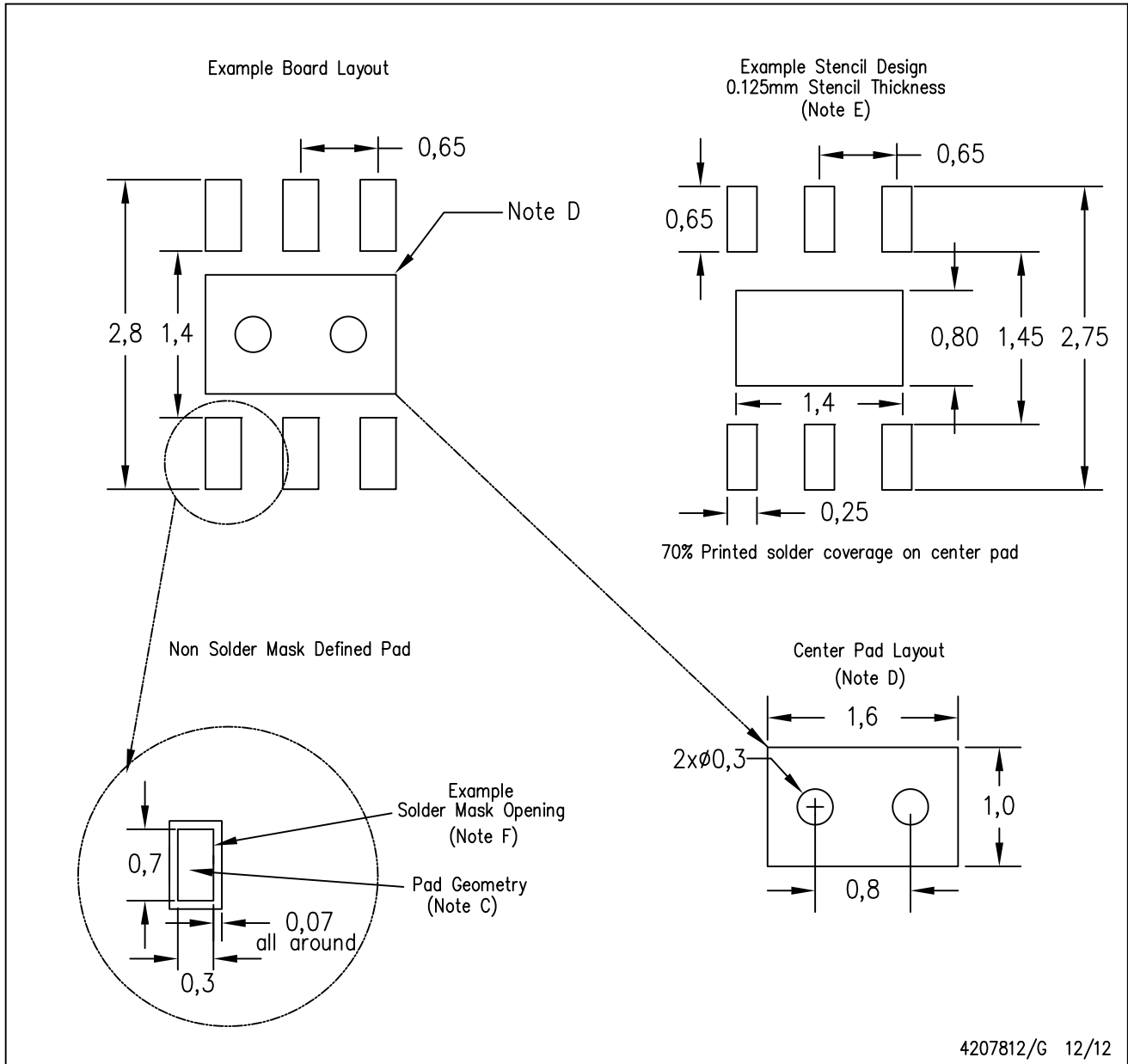

- NOTES:
- A. All linear dimensions are in millimeters.
 - B. This drawing is subject to change without notice.
 - C. Publication IPC-7351 is recommended for alternate designs.
 - D. This package is designed to be soldered to a thermal pad on the board. Refer to Application Note, QFN/SON PCB Attachment, Texas Instruments Literature No. SLUA271, and also the Product Data Sheets for specific thermal information, via requirements, and recommended board layout. These documents are available at www.ti.com <<http://www.ti.com>>.
 - E. Laser cutting apertures with trapezoidal walls and also rounding corners will offer better paste release. Customers should contact their board assembly site for stencil design recommendations. Refer to IPC 7525 for stencil design considerations.
 - F. Customers should contact their board fabrication site for solder mask tolerances.

IMPORTANT NOTICE

Texas Instruments Incorporated and its subsidiaries (TI) reserve the right to make corrections, enhancements, improvements and other changes to its semiconductor products and services per JESD46, latest issue, and to discontinue any product or service per JESD48, latest issue. Buyers should obtain the latest relevant information before placing orders and should verify that such information is current and complete. All semiconductor products (also referred to herein as "components") are sold subject to TI's terms and conditions of sale supplied at the time of order acknowledgment.

TI warrants performance of its components to the specifications applicable at the time of sale, in accordance with the warranty in TI's terms and conditions of sale of semiconductor products. Testing and other quality control techniques are used to the extent TI deems necessary to support this warranty. Except where mandated by applicable law, testing of all parameters of each component is not necessarily performed.

TI assumes no liability for applications assistance or the design of Buyers' products. Buyers are responsible for their products and applications using TI components. To minimize the risks associated with Buyers' products and applications, Buyers should provide adequate design and operating safeguards.

TI does not warrant or represent that any license, either express or implied, is granted under any patent right, copyright, mask work right, or other intellectual property right relating to any combination, machine, or process in which TI components or services are used. Information published by TI regarding third-party products or services does not constitute a license to use such products or services or a warranty or endorsement thereof. Use of such information may require a license from a third party under the patents or other intellectual property of the third party, or a license from TI under the patents or other intellectual property of TI.

Reproduction of significant portions of TI information in TI data books or data sheets is permissible only if reproduction is without alteration and is accompanied by all associated warranties, conditions, limitations, and notices. TI is not responsible or liable for such altered documentation. Information of third parties may be subject to additional restrictions.

Resale of TI components or services with statements different from or beyond the parameters stated by TI for that component or service voids all express and any implied warranties for the associated TI component or service and is an unfair and deceptive business practice. TI is not responsible or liable for any such statements.

Buyer acknowledges and agrees that it is solely responsible for compliance with all legal, regulatory and safety-related requirements concerning its products, and any use of TI components in its applications, notwithstanding any applications-related information or support that may be provided by TI. Buyer represents and agrees that it has all the necessary expertise to create and implement safeguards which anticipate dangerous consequences of failures, monitor failures and their consequences, lessen the likelihood of failures that might cause harm and take appropriate remedial actions. Buyer will fully indemnify TI and its representatives against any damages arising out of the use of any TI components in safety-critical applications.

In some cases, TI components may be promoted specifically to facilitate safety-related applications. With such components, TI's goal is to help enable customers to design and create their own end-product solutions that meet applicable functional safety standards and requirements. Nonetheless, such components are subject to these terms.

No TI components are authorized for use in FDA Class III (or similar life-critical medical equipment) unless authorized officers of the parties have executed a special agreement specifically governing such use.

Only those TI components which TI has specifically designated as military grade or "enhanced plastic" are designed and intended for use in military/aerospace applications or environments. Buyer acknowledges and agrees that any military or aerospace use of TI components which have **not** been so designated is solely at the Buyer's risk, and that Buyer is solely responsible for compliance with all legal and regulatory requirements in connection with such use.

TI has specifically designated certain components as meeting ISO/TS16949 requirements, mainly for automotive use. In any case of use of non-designated products, TI will not be responsible for any failure to meet ISO/TS16949.

Products

Audio	www.ti.com/audio
Amplifiers	amplifier.ti.com
Data Converters	dataconverter.ti.com
DLP® Products	www.dlp.com
DSP	dsp.ti.com
Clocks and Timers	www.ti.com/clocks
Interface	interface.ti.com
Logic	logic.ti.com
Power Mgmt	power.ti.com
Microcontrollers	microcontroller.ti.com
RFID	www.ti-rfid.com
OMAP Applications Processors	www.ti.com/omap
Wireless Connectivity	www.ti.com/wirelessconnectivity

Applications

Automotive and Transportation	www.ti.com/automotive
Communications and Telecom	www.ti.com/communications
Computers and Peripherals	www.ti.com/computers
Consumer Electronics	www.ti.com/consumer-apps
Energy and Lighting	www.ti.com/energy
Industrial	www.ti.com/industrial
Medical	www.ti.com/medical
Security	www.ti.com/security
Space, Avionics and Defense	www.ti.com/space-avionics-defense
Video and Imaging	www.ti.com/video

TI E2E Community

e2e.ti.com