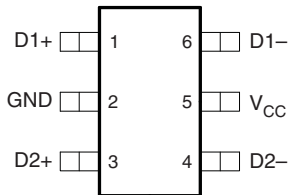
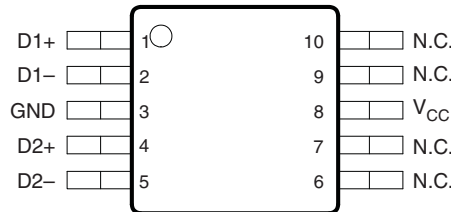
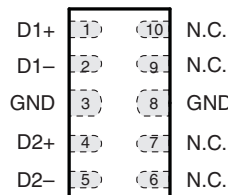
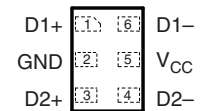

4-CHANNEL ESD SOLUTION FOR HIGH-SPEED DIFFERENTIAL INTERFACE

 Check for Samples: [TPD4S009](#), [TPD4S010](#)

FEATURES

- Supports High-Speed Differential Data Rates (3-dB Bandwidth > 4 GHz)
- Ultra-low Matching Capacitance Between Differential Signal Pairs
- Low 0.8-pF Line Capacitance for Each Data Line to GND
- Flow-Through Single-in-Line Pin Mapping for High-Speed Lines Ensures No Additional Board Layout Burden While Placing ESD Protection Chip Near Connector
- IEC 61000-4-2 (Level 4) System-Level ESD Compliance
- 2.5-A Peak Pulse Current (8/20- μ s Pulse)
- I_{off} Feature for the TPD4S009
- Industrial Temperature Range: -40°C to 85°C
- Space-Saving Package Options

 TPD4S009...DBV OR DCK PACKAGE
(TOP VIEW)

 TPD4S009...DGS PACKAGE
(TOP VIEW)

 TPD4S010...DQA PACKAGE
(TOP VIEW)

 TPD4S009...DRY PACKAGE
(TOP VIEW)

DESCRIPTION/ORDERING INFORMATION

The TPD4S009 and TPD4S010 provide system level electrostatic discharge (ESD) solution for high-speed differential lines. These devices offer four ESD clamp circuits for dual pair differential lines. The TPD4S009 offers an optional V_{CC} supply pin which can be connected to system supply plane. There is a blocking diode at the V_{CC} pin to enable the I_{off} feature for the TPD4S009. The TPD4S009 can handle live signal at the D+, D- pins when the V_{CC} pin is connected to zero volt. The V_{CC} pin allows all the internal circuit nodes of the TPD4S009 to be at known potential during start up time. However, connecting the optional V_{CC} pin to board supply plane doesn't affect the system level ESD performance of the TPD4S009. The TPD4S010 does not offer the V_{CC} pin.

The TPD4S009 is offered in DBV, DCK, DGS, and DRY packages. The TPD4S010 is offered in DQA package. The TPD4S009DRYR is the most space saving package option available for dual pair high-speed differential lines. The TPD4S009DGSR and TPD4S010DQAR offer flow-through board layout option to reduce signal glitches due to mismatch between the D+ and D- signal pair routing.

The monolithic silicon technology allows matching between the differential signal pairs. The excellent matching between the differential pair signal lines (0.05-pF line-line capacitance for the TPD4S009DRY) enables this device to operate at high-speed differential data rates (3-dB bandwidth > 4 GHz). The TPD4S009 and TPD4S010 are suitable for high-speed differential applications, such as high-definition multimedia interface (HDMI), low-voltage differential signaling (LVDS), serial advanced technology attachment (SATA), Ethernet, 1394 (FireWire[®]), etc.

TPD4S009/TPD4S010 comply with IEC 61000-4-2 (Level 4) ESD.

TPD4S009/TPD4S010 are characterized for operation over the ambient air temperature range of -40°C to 85°C .



Please be aware that an important notice concerning availability, standard warranty, and use in critical applications of Texas Instruments semiconductor products and disclaimers thereto appears at the end of this data sheet.

FireWire is a registered trademark of Apple Inc.

ORDERING INFORMATION

T _A	PACKAGE ^{(1) (2)}		NOMINAL DIMENSIONS (mm)	ORDERABLE PART NUMBER	TOP-SIDE MARKING ⁽³⁾
-40°C to 85°C	MSOP – DGS	Reel of 3000	W = 4.9, L = 3, H < 1.1, Pitch = 0.5	TPD4S009DGSR	3HR
	SON – DQA	Reel of 3000	W = 1, L = 2.5, H < 1.1, Pitch = 0.5	TPD4S010DQAR	4U_
	SON – DRY	Reel of 5000	W = 1, L = 1.45, H = 0.55, Pitch = 0.5	TPD4S009DRYR	3H
	SOT (SC-70) – DCK	Reel of 3000	W = 2.1, L = 2, H = 0.95, Pitch = 0.65	TPD4S009DCKR	3H_
	SOT (SOT-23) – DBV	Reel of 3000	W = 2.9, L = 2.8, H < 1.45, Pitch = 0.95	TPD4S009DBVR	NFJK

- (1) Package drawings, thermal data, and symbolization are available at www.ti.com/packaging.
- (2) For the most current package and ordering information, see the Package Option Addendum at the end of this document, or see the TI website at www.ti.com.
- (3) DCK, DQA: The actual top-side marking has one additional character that designates wafer fab/assembly site.

CIRCUIT DIAGRAMS

Figure 1. TPD4S009

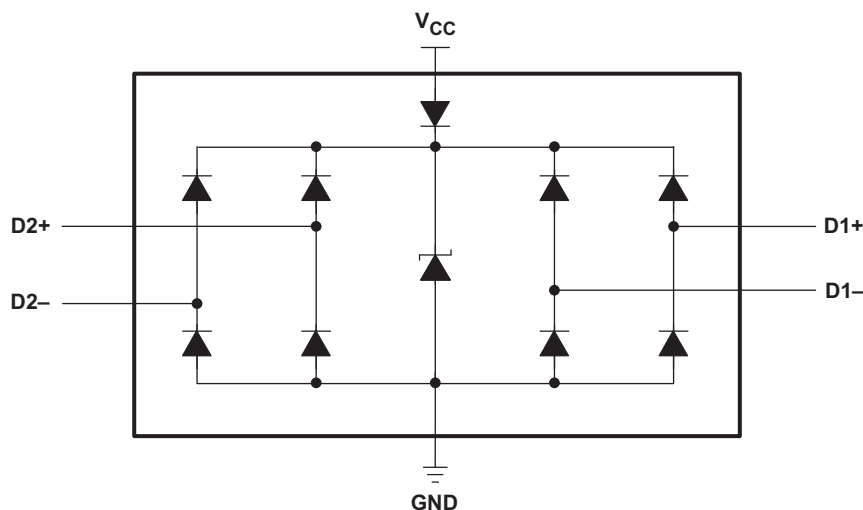
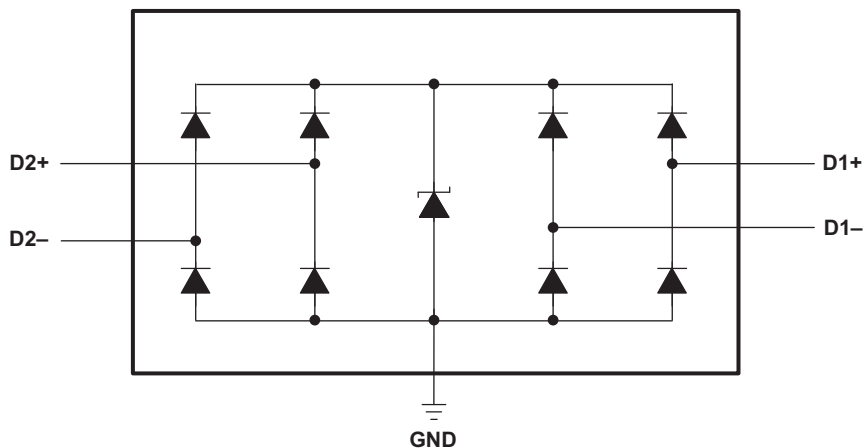

Figure 2. TPD4S010



TERMINAL FUNCTIONS

DBV, DCK, OR DRY PIN NO.	DGS PIN NO.	DQA PIN NO.	NAME	I/O	DESCRIPTION
1, 6, 3, 4	1, 2, 4, 5	1, 2, 4, 5	D1+, D1–, D2+, D2–	ESD port	High-speed ESD clamp provides ESD protection to the high-speed differential data lines.
2	3	3, 8	GND	GND	Ground
–	6, 7, 9, 10	6, 7, 9, 10	N.C.	–	Not internally connected
5	8	–	V _{CC}	Power	Supply

ABSOLUTE MAXIMUM RATINGS

over operating free-air temperature range (unless otherwise noted)

		MIN	MAX	UNIT
V_{CC}	Supply voltage range for TPD4S009	-0.3	6	V
V_{IO}	IO signal voltage range	0	V_{CC}	V
T_{stg}	Storage temperature range	-65	125	°C
T_A	Characterized free-air operating temperature range	-40	85	°C
	Lead temperature, 1.6 mm (1/16 in) from case for 10 s		260	°C
	IEC 61000-4-2 Contact Discharge		±8	kV
	IEC 61000-4-2 Air-Gap Discharge		±9	kV
	Peak pulse power ($t_p = 8/20 \mu s$)		25	W
	Peak pulse current ($t_p = 8/20 \mu s$)		2.5	A

ELECTRICAL CHARACTERISTICS

over operating free-air temperature range (unless otherwise noted)

PARAMETER		TEST CONDITIONS		MIN	TYP	MAX	UNIT
V_{RWM}	Reverse standoff voltage	Any IO pin to ground				5.5	V
V_{BR}	Breakdown voltage	$I_{IO} = 1 \text{ mA}$	Any IO pin to ground	9			V
I_{IO}	IO port current	$V_{IO} = 3.3 \text{ V}, V_{CC} = 5 \text{ V}$	Any IO pin		0.01	0.1	μA
I_{off}	Current from IO port to supply pins	$V_{IO} = 3.3 \text{ V}, V_{CC} = 5 \text{ V}$	Any IO pin		0.01	0.1	μA
V_D	Diode forward voltage	$I_{IO} = 8 \text{ mA}$	Lower clamp diode	0.6	0.8	0.95	V
R_{DYN}	Dynamic resistance	$I = 1 \text{ A}$	Any IO pin		1.1		Ω
C_{IO}	IO capacitance	$V_{CC} = 5 \text{ V}, V_{IO} = 2.5 \text{ V}$	Any IO pin		0.8		pF
I_{CC}	Operating supply current	$V_{IO} = \text{Open}, V_{CC} = 5 \text{ V}$	V_{CC} pin		0.1	1	μA

TYPICAL CHARACTERISTICS

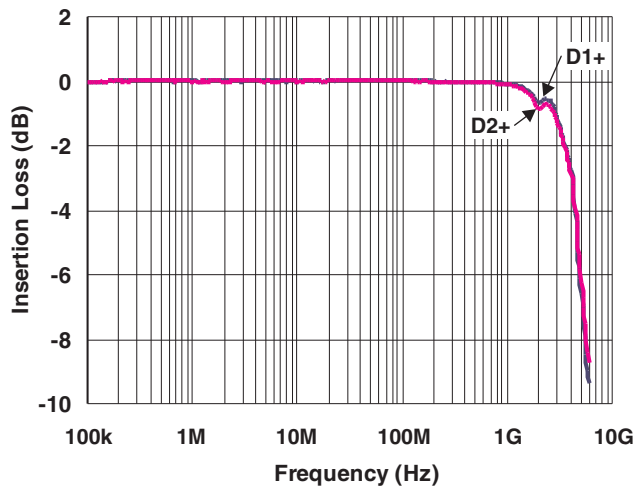

Figure 3. Insertion Loss S21 – I/O to GND

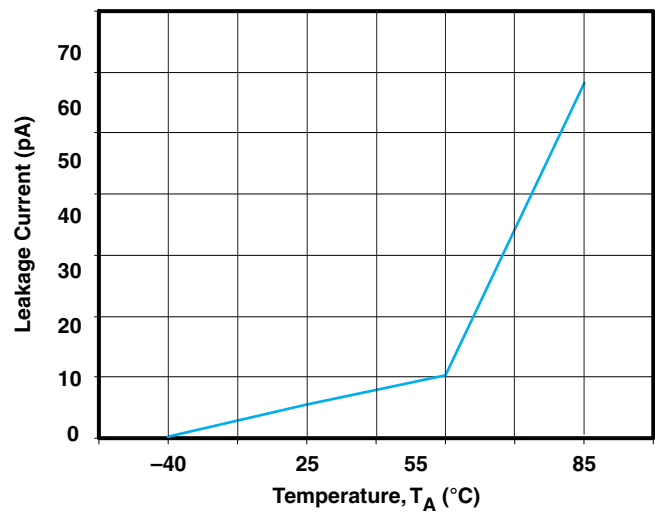

Figure 4. Leakage Current vs Temperature ($V_{IO} = 2.5\text{ V}$)

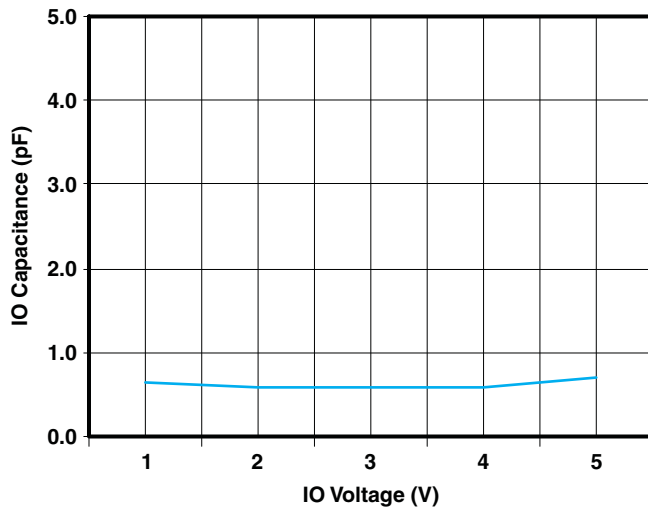

Figure 5. IO Capacitance vs Input Voltage ($V_{CC} = 5\text{ V}$)

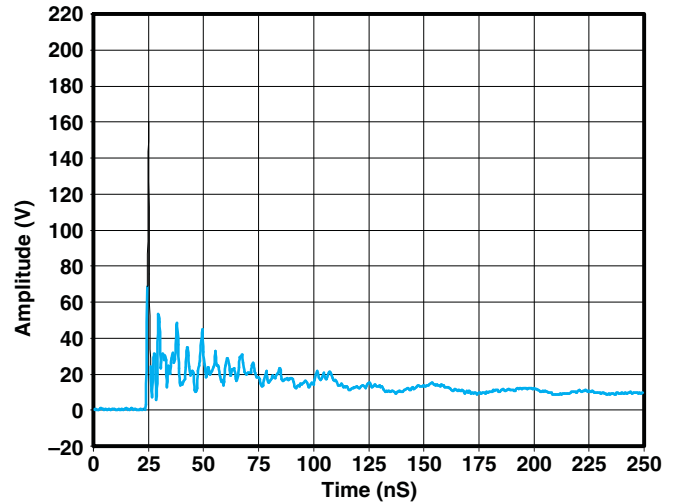

Figure 6. IEC Clamping Waveforms
(8-kV Contact, Average of Ten Waveforms)

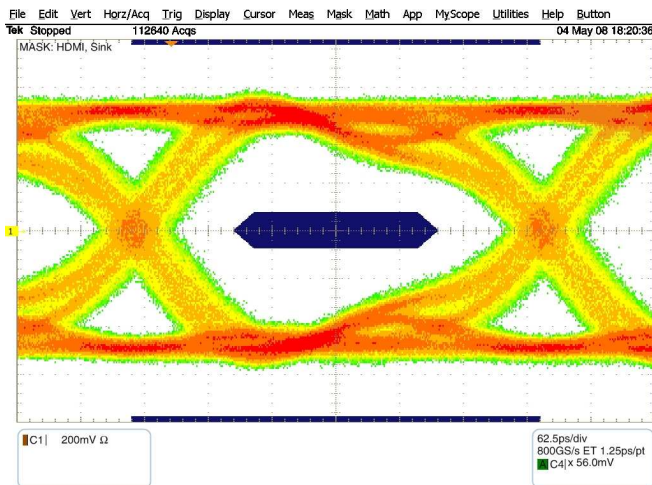
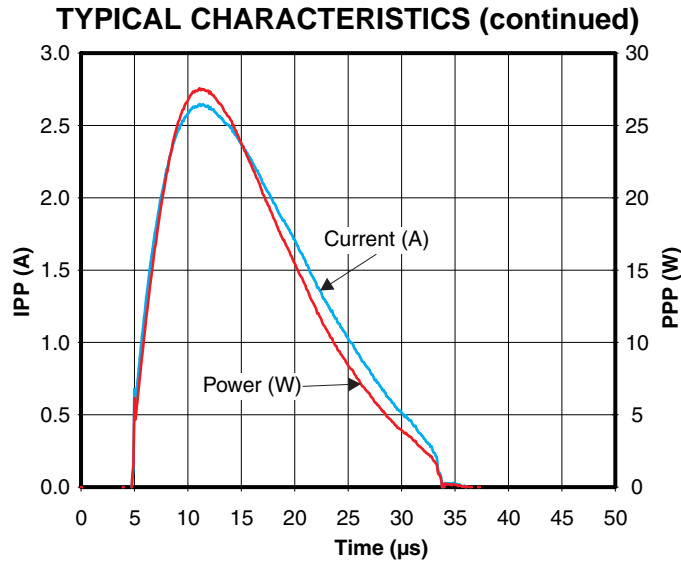

Figure 8. Eye Diagram Without TPD4S009

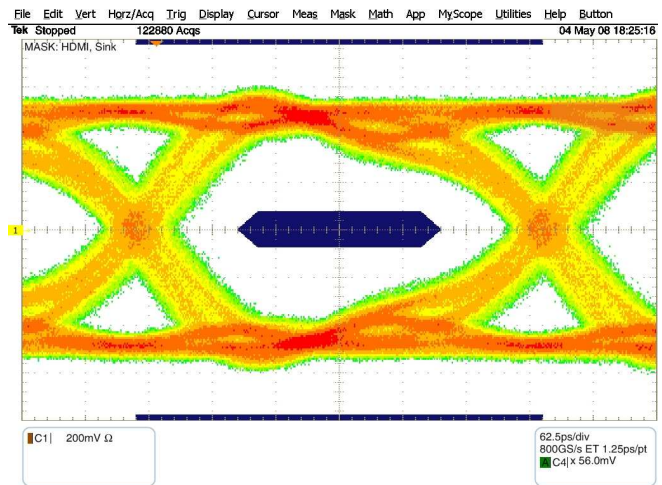

Figure 9. Eye Diagram With TPD4S009

REVISION HISTORY

Changes from Revision D (March 2010) to Revision E	Page
• Changed TOP-SIDE MARKING for the TPD4S010DQAR package	2

PACKAGING INFORMATION

Orderable Device	Status (1)	Package Type	Package Drawing	Pins	Package Qty	Eco Plan (2)	Lead/Ball Finish	MSL Peak Temp (3)	Op Temp (°C)	Top-Side Markings (4)	Samples
TPD4S009DBVR	ACTIVE	SOT-23	DBV	6	3000	Green (RoHS & no Sb/Br)	CU NIPDAU	Level-1-260C-UNLIM	-40 to 85	NFJK	Samples
TPD4S009DBVRG4	ACTIVE	SOT-23	DBV	6	3000	Green (RoHS & no Sb/Br)	CU NIPDAU	Level-1-260C-UNLIM	-40 to 85	NFJK	Samples
TPD4S009DCKR	ACTIVE	SC70	DCK	6	3000	Green (RoHS & no Sb/Br)	CU NIPDAU	Level-1-260C-UNLIM	-40 to 85	3HR	Samples
TPD4S009DCKRG4	ACTIVE	SC70	DCK	6	3000	Green (RoHS & no Sb/Br)	CU NIPDAU	Level-1-260C-UNLIM	-40 to 85	3HR	Samples
TPD4S009DGSR	ACTIVE	VSSOP	DGS	10	2500	Green (RoHS & no Sb/Br)	CU NIPDAU	Level-1-260C-UNLIM	-40 to 85	3HR	Samples
TPD4S009DRYR	ACTIVE	SON	DRY	6	5000	Green (RoHS & no Sb/Br)	CU NIPDAU	Level-1-260C-UNLIM	-40 to 85	3H	Samples
TPD4S010DQAR	ACTIVE	SON	DQA	10	3000	Green (RoHS & no Sb/Br)	CU NIPDAU	Level-1-260C-UNLIM	-40 to 85	(4U7 ~ 4UO ~ 4UR)	Samples

(1) The marketing status values are defined as follows:

ACTIVE: Product device recommended for new designs.

LIFEBUY: TI has announced that the device will be discontinued, and a lifetime-buy period is in effect.

NRND: Not recommended for new designs. Device is in production to support existing customers, but TI does not recommend using this part in a new design.

PREVIEW: Device has been announced but is not in production. Samples may or may not be available.

OBSOLETE: TI has discontinued the production of the device.

(2) Eco Plan - The planned eco-friendly classification: Pb-Free (RoHS), Pb-Free (RoHS Exempt), or Green (RoHS & no Sb/Br) - please check <http://www.ti.com/productcontent> for the latest availability information and additional product content details.

TBD: The Pb-Free/Green conversion plan has not been defined.

Pb-Free (RoHS): TI's terms "Lead-Free" or "Pb-Free" mean semiconductor products that are compatible with the current RoHS requirements for all 6 substances, including the requirement that lead not exceed 0.1% by weight in homogeneous materials. Where designed to be soldered at high temperatures, TI Pb-Free products are suitable for use in specified lead-free processes.

Pb-Free (RoHS Exempt): This component has a RoHS exemption for either 1) lead-based flip-chip solder bumps used between the die and package, or 2) lead-based die adhesive used between the die and leadframe. The component is otherwise considered Pb-Free (RoHS compatible) as defined above.

Green (RoHS & no Sb/Br): TI defines "Green" to mean Pb-Free (RoHS compatible), and free of Bromine (Br) and Antimony (Sb) based flame retardants (Br or Sb do not exceed 0.1% by weight in homogeneous material)

(3) MSL, Peak Temp. -- The Moisture Sensitivity Level rating according to the JEDEC industry standard classifications, and peak solder temperature.

(4) Multiple Top-Side Markings will be inside parentheses. Only one Top-Side Marking contained in parentheses and separated by a "~" will appear on a device. If a line is indented then it is a continuation of the previous line and the two combined represent the entire Top-Side Marking for that device.

Important Information and Disclaimer: The information provided on this page represents TI's knowledge and belief as of the date that it is provided. TI bases its knowledge and belief on information provided by third parties, and makes no representation or warranty as to the accuracy of such information. Efforts are underway to better integrate information from third parties. TI has taken and continues to take reasonable steps to provide representative and accurate information but may not have conducted destructive testing or chemical analysis on incoming materials and chemicals. TI and TI suppliers consider certain information to be proprietary, and thus CAS numbers and other limited information may not be available for release.

In no event shall TI's liability arising out of such information exceed the total purchase price of the TI part(s) at issue in this document sold by TI to Customer on an annual basis.

TAPE AND REEL INFORMATION
REEL DIMENSIONS

TAPE DIMENSIONS

A0	Dimension designed to accommodate the component width
B0	Dimension designed to accommodate the component length
K0	Dimension designed to accommodate the component thickness
W	Overall width of the carrier tape
P1	Pitch between successive cavity centers

TAPE AND REEL INFORMATION

*All dimensions are nominal

Device	Package Type	Package Drawing	Pins	SPQ	Reel Diameter (mm)	Reel Width W1 (mm)	A0 (mm)	B0 (mm)	K0 (mm)	P1 (mm)	W (mm)	Pin1 Quadrant
TPD4S009DBVR	SOT-23	DBV	6	3000	180.0	9.2	3.17	3.23	1.37	4.0	8.0	Q3
TPD4S009DCKR	SC70	DCK	6	3000	180.0	8.4	2.25	2.4	1.22	4.0	8.0	Q3
TPD4S009DRYR	SON	DRY	6	5000	179.0	8.4	1.2	1.65	0.7	4.0	8.0	Q1
TPD4S010DQAR	SON	DQA	10	3000	180.0	8.4	1.3	2.83	0.65	4.0	8.0	Q1
TPD4S010DQAR	SON	DQA	10	3000	180.0	9.5	1.23	2.7	0.7	4.0	8.0	Q1
TPD4S010DQAR	SON	DQA	10	3000	179.0	8.4	1.25	2.8	0.7	4.0	8.0	Q1

TAPE AND REEL BOX DIMENSIONS

*All dimensions are nominal

Device	Package Type	Package Drawing	Pins	SPQ	Length (mm)	Width (mm)	Height (mm)
TPD4S009DBVR	SOT-23	DBV	6	3000	205.0	200.0	33.0
TPD4S009DCKR	SC70	DCK	6	3000	202.0	201.0	28.0
TPD4S009DRYR	SON	DRY	6	5000	203.0	203.0	35.0
TPD4S010DQAR	SON	DQA	10	3000	202.0	201.0	28.0
TPD4S010DQAR	SON	DQA	10	3000	180.0	180.0	30.0
TPD4S010DQAR	SON	DQA	10	3000	203.0	203.0	35.0

DBV (R-PDSO-G6)

PLASTIC SMALL-OUTLINE PACKAGE



- NOTES:
- A. All linear dimensions are in millimeters.
 - B. This drawing is subject to change without notice.
 - C. Body dimensions do not include mold flash or protrusion. Mold flash and protrusion shall not exceed 0.15 per side.
 - D. Leads 1,2,3 may be wider than leads 4,5,6 for package orientation.
- $\triangle E$ Falls within JEDEC MO-178 Variation AB, except minimum lead width.

DBV (R-PDSO-G6)

PLASTIC SMALL OUTLINE

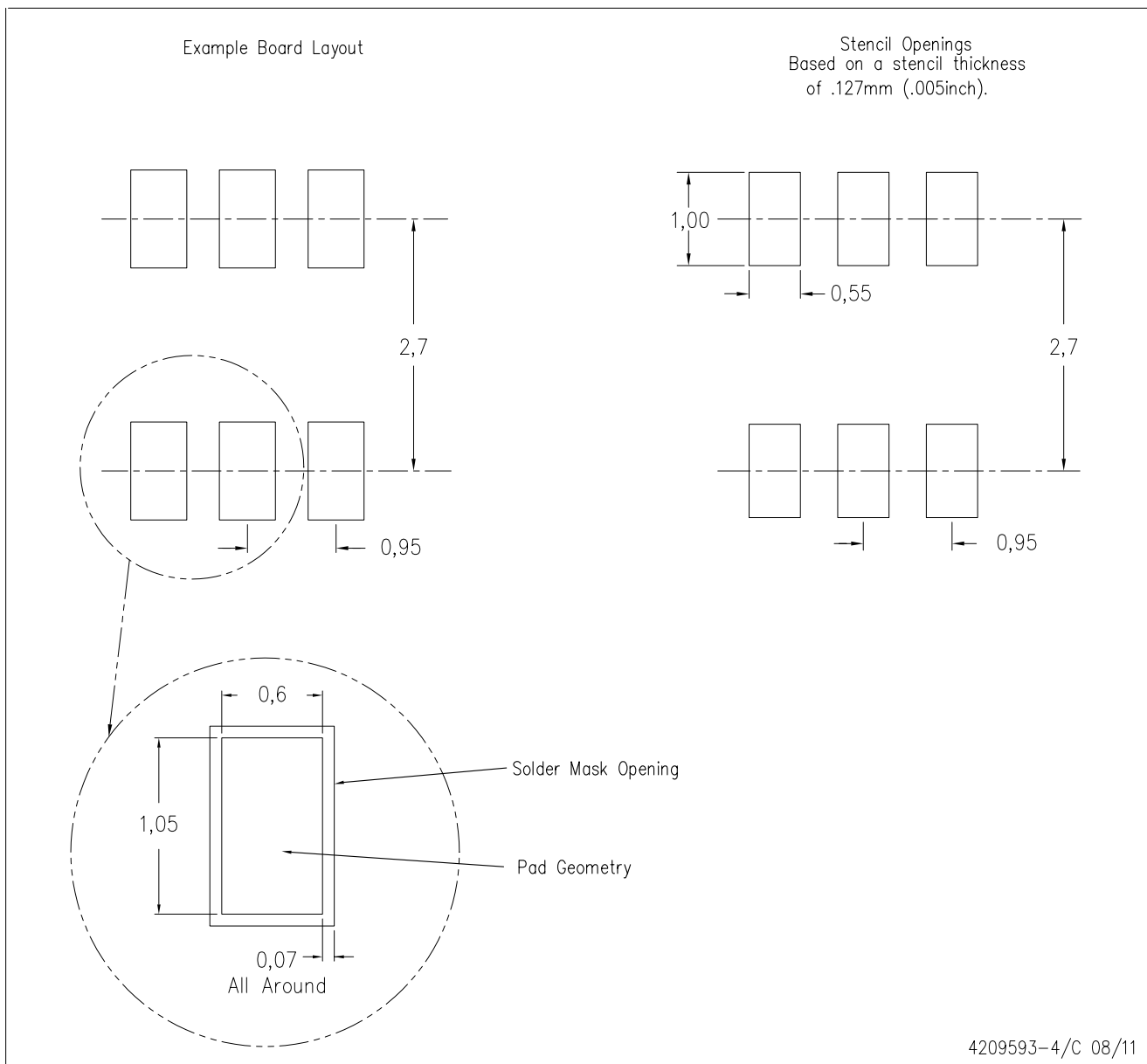

- NOTES:
- A. All linear dimensions are in millimeters.
 - B. This drawing is subject to change without notice.
 - C. Customers should place a note on the circuit board fabrication drawing not to alter the center solder mask defined pad.
 - D. Publication IPC-7351 is recommended for alternate designs.
 - E. Laser cutting apertures with trapezoidal walls and also rounding corners will offer better paste release. Customers should contact their board assembly site for stencil design recommendations. Example stencil design based on a 50% volumetric metal load solder paste. Refer to IPC-7525 for other stencil recommendations.

DGS (S-PDSO-G10)

PLASTIC SMALL-OUTLINE PACKAGE



- NOTES:
- A. All linear dimensions are in millimeters.
 - B. This drawing is subject to change without notice.
 - C. Body dimensions do not include mold flash or protrusion.
 - D. Falls within JEDEC MO-187 variation BA.

DCK (R-PDSO-G6)

PLASTIC SMALL-OUTLINE PACKAGE





- NOTES:
- A. All linear dimensions are in millimeters.
 - B. This drawing is subject to change without notice.
 - C. Body dimensions do not include mold flash or protrusion. Mold flash and protrusion shall not exceed 0.15 per side.
 - D. Falls within JEDEC MO-203 variation AB.

DRY (R-PUSON-N6)

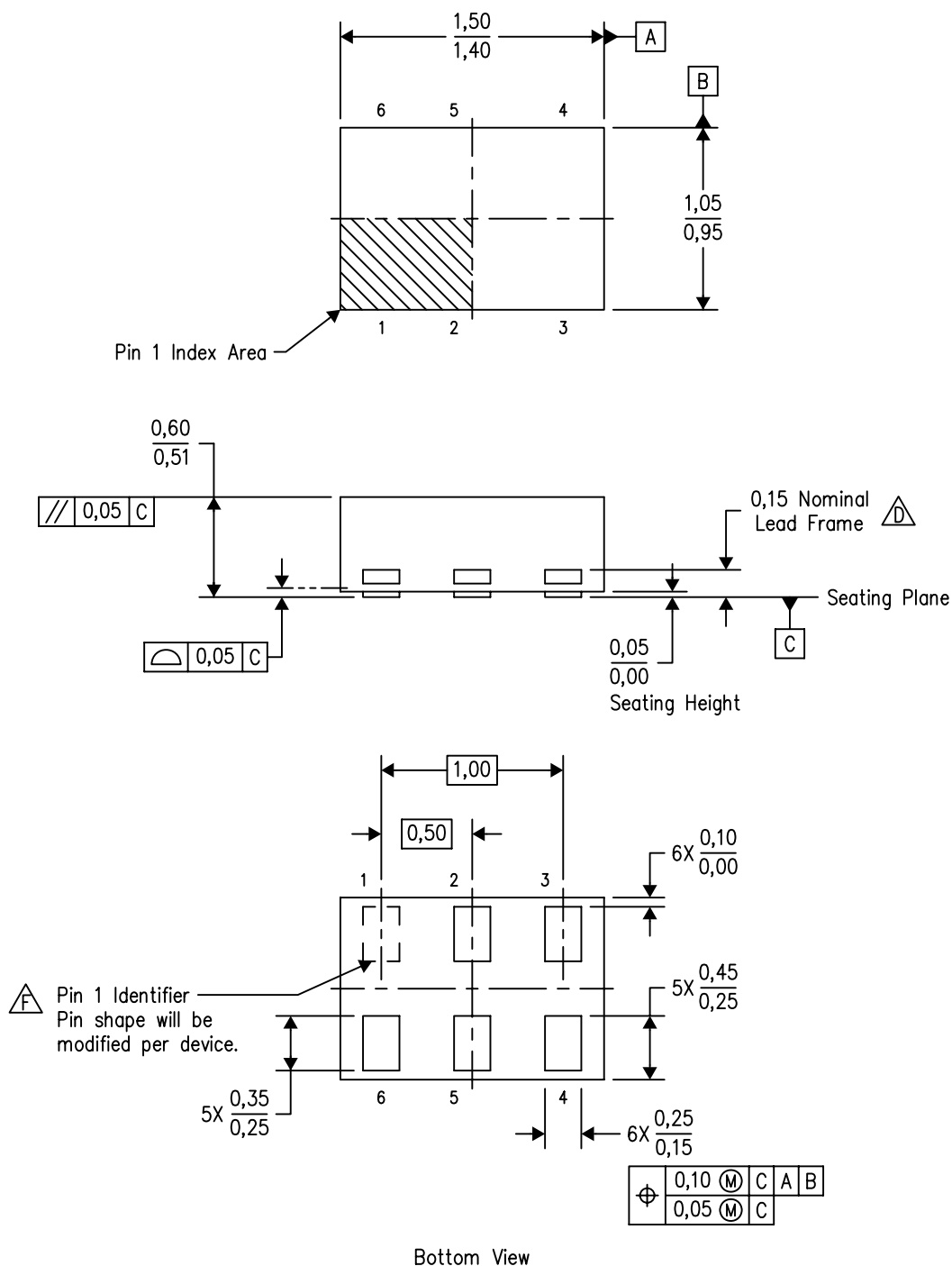
PLASTIC SMALL OUTLINE NO-LEAD



4207181/F 12/11

- NOTES:
- A. All linear dimensions are in millimeters. Dimensioning and tolerancing per ASME Y14.5M-1994.
 - B. This drawing is subject to change without notice.
 - C. SON (Small Outline No-Lead) package configuration.
 -  The exposed lead frame feature on side of package may or may not be present due to alternative lead frame designs.
 - E. This package complies to JEDEC MO-287 variation UFAD.
 -  See the additional figure in the Product Data Sheet for details regarding the pin 1 identifier shape.

DRY (R-PUSON-N6)

PLASTIC SMALL OUTLINE NO-LEAD

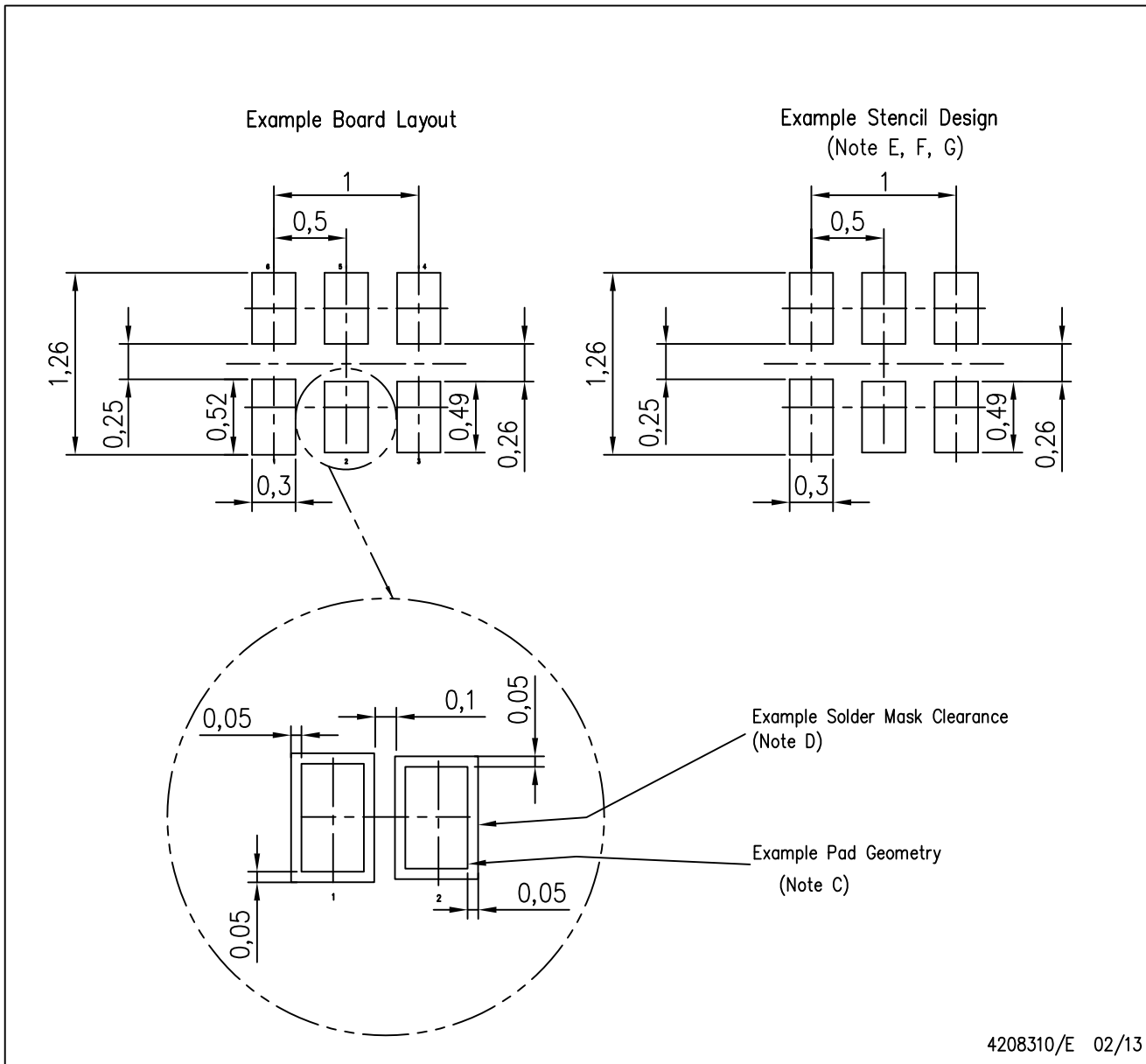

- NOTES:
- All linear dimensions are in millimeters.
 - This drawing is subject to change without notice.
 - Publication IPC-7351 is recommended for alternate designs.
 - Customers should contact their board fabrication site for minimum solder mask web tolerances between signal pads.
 - Maximum stencil thickness 0,127 mm (5 mils). All linear dimensions are in millimeters.
 - Laser cutting apertures with trapezoidal walls and also rounding corners will offer better paste release. Customers should contact their board assembly site for stencil design recommendations. Refer to IPC 7525 for stencil design considerations.
 - Side aperture dimensions over-print land for acceptable area ratio > 0.66. Customer may reduce side aperture dimensions if stencil manufacturing process allows for sufficient release at smaller opening.

DQA (R-PSON-N10)

PLASTIC SMALL OUTLINE NO-LEAD

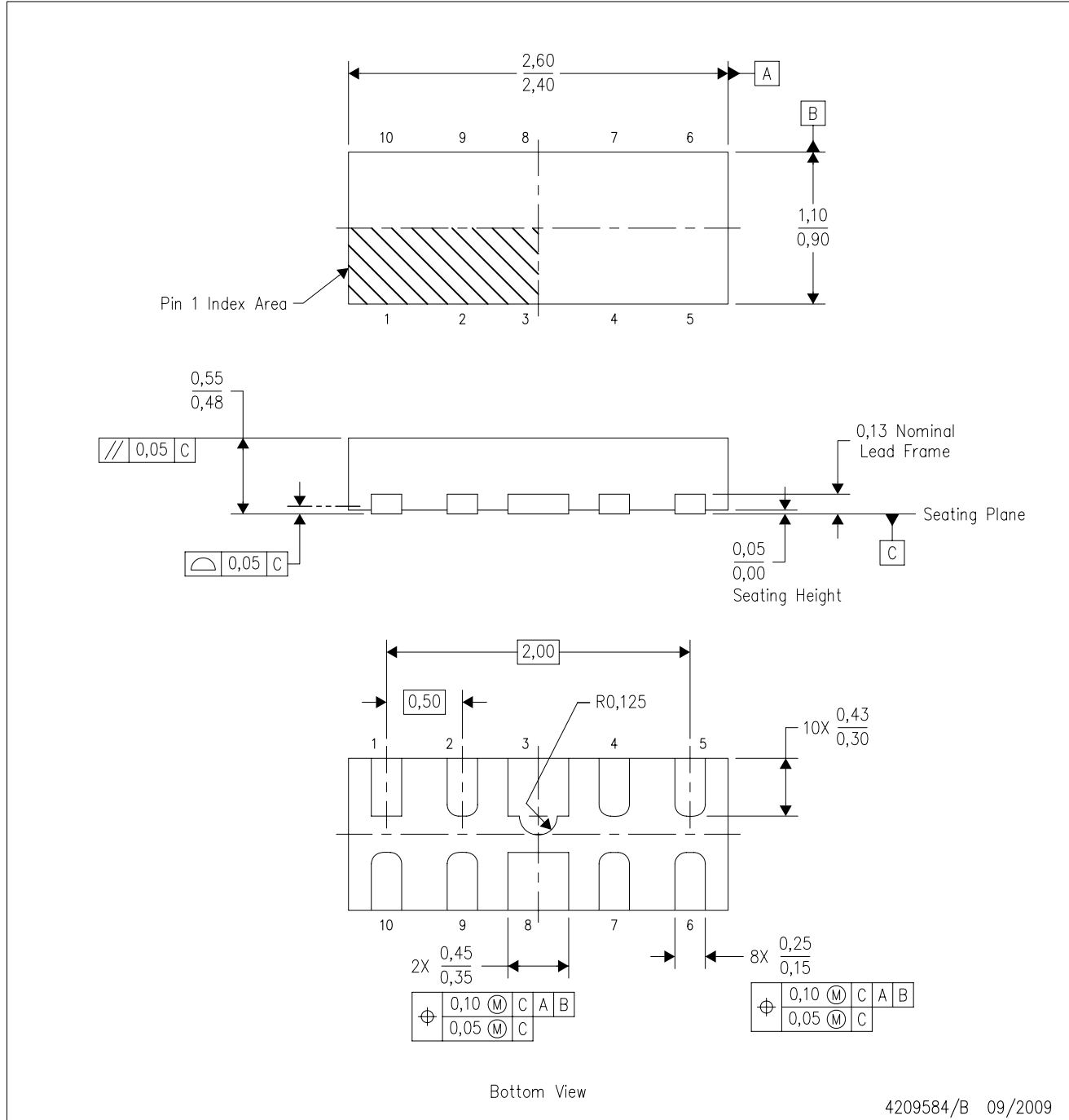

- NOTES:
- A. All linear dimensions are in millimeters. Dimensioning and tolerancing per ASME Y14.5M-1994.
 - B. This drawing is subject to change without notice.
 - C. SON (Small Outline No-Lead) package configuration.

DQA (R-PUSON-N10)

PLASTIC SMALL OUTLINE NO-LEAD

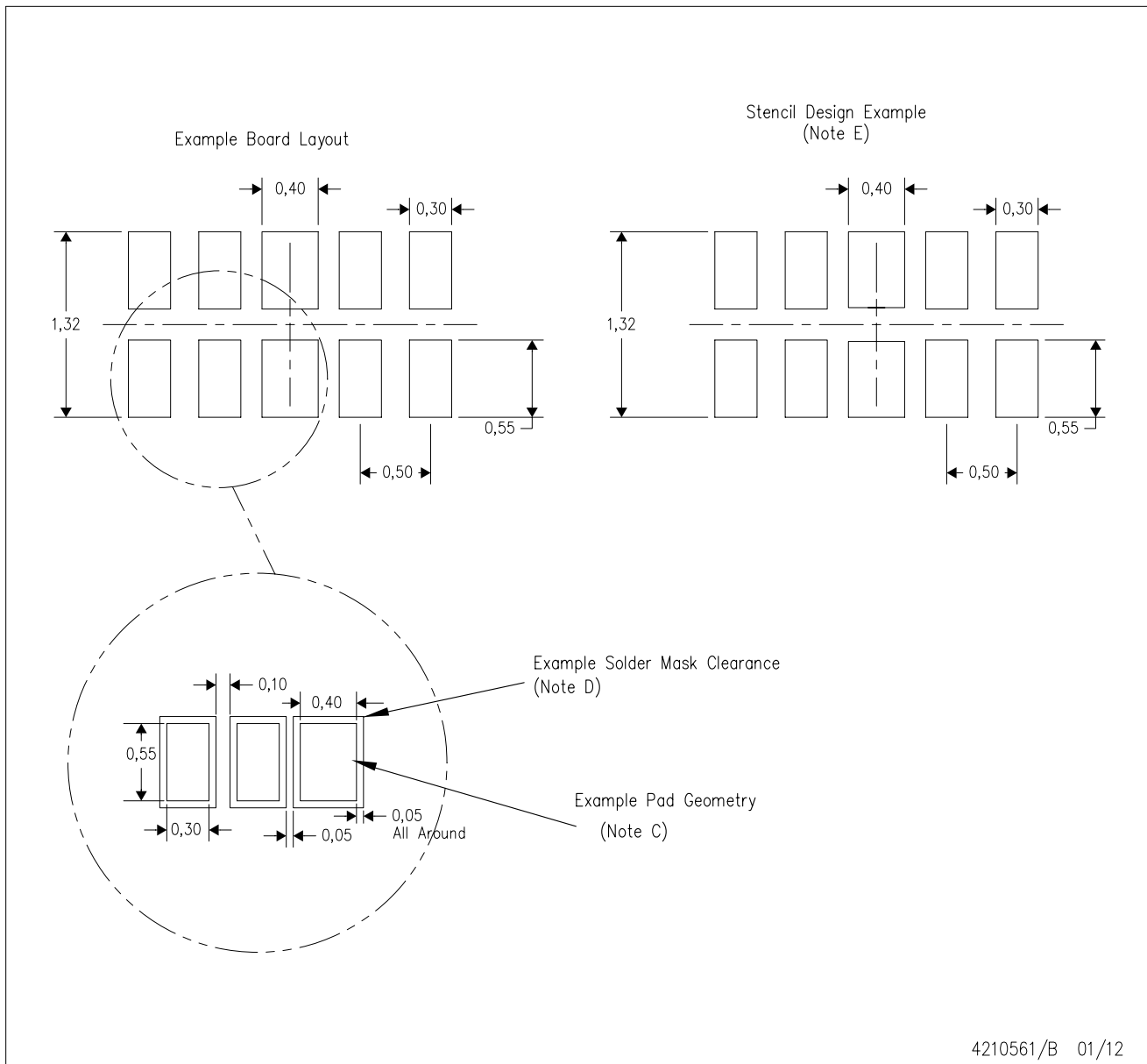

- NOTES:
- A. All linear dimensions are in millimeters.
 - B. This drawing is subject to change without notice.
 - C. Publication IPC-7351 is recommended for alternate designs.
 - D. Customers should contact their board fabrication site for minimum solder mask web tolerances between signal pads.
 - E. Maximum stencil thickness 0,127 mm (5 mils). All linear dimensions are in millimeters.
 - F. Laser cutting apertures with trapezoidal walls and also rounding corners will offer better paste release. Customers should contact their board assembly site for stencil design recommendations. Refer to IPC 7525 for stencil design considerations.
 - G. Side aperture dimensions over-print land for acceptable area ratio > 0.66. Customer may reduce side aperture dimensions if stencil manufacturing process allows for sufficient release at smaller opening.

IMPORTANT NOTICE

Texas Instruments Incorporated and its subsidiaries (TI) reserve the right to make corrections, enhancements, improvements and other changes to its semiconductor products and services per JESD46, latest issue, and to discontinue any product or service per JESD48, latest issue. Buyers should obtain the latest relevant information before placing orders and should verify that such information is current and complete. All semiconductor products (also referred to herein as "components") are sold subject to TI's terms and conditions of sale supplied at the time of order acknowledgment.

TI warrants performance of its components to the specifications applicable at the time of sale, in accordance with the warranty in TI's terms and conditions of sale of semiconductor products. Testing and other quality control techniques are used to the extent TI deems necessary to support this warranty. Except where mandated by applicable law, testing of all parameters of each component is not necessarily performed.

TI assumes no liability for applications assistance or the design of Buyers' products. Buyers are responsible for their products and applications using TI components. To minimize the risks associated with Buyers' products and applications, Buyers should provide adequate design and operating safeguards.

TI does not warrant or represent that any license, either express or implied, is granted under any patent right, copyright, mask work right, or other intellectual property right relating to any combination, machine, or process in which TI components or services are used. Information published by TI regarding third-party products or services does not constitute a license to use such products or services or a warranty or endorsement thereof. Use of such information may require a license from a third party under the patents or other intellectual property of the third party, or a license from TI under the patents or other intellectual property of TI.

Reproduction of significant portions of TI information in TI data books or data sheets is permissible only if reproduction is without alteration and is accompanied by all associated warranties, conditions, limitations, and notices. TI is not responsible or liable for such altered documentation. Information of third parties may be subject to additional restrictions.

Resale of TI components or services with statements different from or beyond the parameters stated by TI for that component or service voids all express and any implied warranties for the associated TI component or service and is an unfair and deceptive business practice. TI is not responsible or liable for any such statements.

Buyer acknowledges and agrees that it is solely responsible for compliance with all legal, regulatory and safety-related requirements concerning its products, and any use of TI components in its applications, notwithstanding any applications-related information or support that may be provided by TI. Buyer represents and agrees that it has all the necessary expertise to create and implement safeguards which anticipate dangerous consequences of failures, monitor failures and their consequences, lessen the likelihood of failures that might cause harm and take appropriate remedial actions. Buyer will fully indemnify TI and its representatives against any damages arising out of the use of any TI components in safety-critical applications.

In some cases, TI components may be promoted specifically to facilitate safety-related applications. With such components, TI's goal is to help enable customers to design and create their own end-product solutions that meet applicable functional safety standards and requirements. Nonetheless, such components are subject to these terms.

No TI components are authorized for use in FDA Class III (or similar life-critical medical equipment) unless authorized officers of the parties have executed a special agreement specifically governing such use.

Only those TI components which TI has specifically designated as military grade or "enhanced plastic" are designed and intended for use in military/aerospace applications or environments. Buyer acknowledges and agrees that any military or aerospace use of TI components which have **not** been so designated is solely at the Buyer's risk, and that Buyer is solely responsible for compliance with all legal and regulatory requirements in connection with such use.

TI has specifically designated certain components as meeting ISO/TS16949 requirements, mainly for automotive use. In any case of use of non-designated products, TI will not be responsible for any failure to meet ISO/TS16949.

Products

Audio	www.ti.com/audio
Amplifiers	amplifier.ti.com
Data Converters	dataconverter.ti.com
DLP® Products	www.dlp.com
DSP	dsp.ti.com
Clocks and Timers	www.ti.com/clocks
Interface	interface.ti.com
Logic	logic.ti.com
Power Mgmt	power.ti.com
Microcontrollers	microcontroller.ti.com
RFID	www.ti-rfid.com
OMAP Applications Processors	www.ti.com/omap
Wireless Connectivity	www.ti.com/wirelessconnectivity

Applications

Automotive and Transportation	www.ti.com/automotive
Communications and Telecom	www.ti.com/communications
Computers and Peripherals	www.ti.com/computers
Consumer Electronics	www.ti.com/consumer-apps
Energy and Lighting	www.ti.com/energy
Industrial	www.ti.com/industrial
Medical	www.ti.com/medical
Security	www.ti.com/security
Space, Avionics and Defense	www.ti.com/space-avionics-defense
Video and Imaging	www.ti.com/video

TI E2E Community

e2e.ti.com