

1.0-A LOW-NOISE FAST-TRANSIENT-RESPONSE LOW-DROPOUT REGULATOR

Check for Samples: [TPS73801](#)

FEATURES

- Optimized for Fast Transient Response
- Output Current: 1.0 A
- Dropout Voltage: 300 mV
- Low Noise: 45 μV_{RMS} (10 Hz to 100 kHz)
- 1-mA Quiescent Current
- No Protection Diodes Needed
- Controlled Quiescent Current in Dropout
- Adjustable Output Voltage: 1.21 V to 20 V
- Less Than 1- μA Quiescent Current in Shutdown
- Stable with 10- μF Output Capacitor
- Stable with Ceramic Capacitors
- Reverse-Battery Protection
- No Reverse Current
- Thermal Limiting

APPLICATIONS

- 3.3-V to 2.5-V Logic Power Supplies
- Post Regulator for Switching Supplies
- Portable/Battery-Powered Equipment.

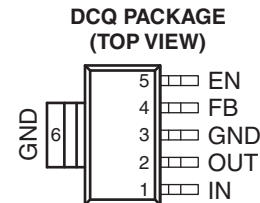

DESCRIPTION/ORDERING INFORMATION

The TPS73801 is a low-dropout (LDO) regulator optimized for fast transient response. The device can supply 1.0 A of output current with a dropout voltage of 300 mV. Operating quiescent current is 1 mA, dropping to less than 1 μA in shutdown. Quiescent current is well controlled; it does not rise in dropout as it does with many other regulators. In addition to fast transient response, the TPS73801 regulators have very low output noise, which makes them ideal for sensitive RF supply applications.

Output voltage range is from 1.21 V to 20 V. The TPS73801 regulators are stable with output capacitors as low as 10 μF . Small ceramic capacitors can be used without the necessary addition of ESR, as is common with other regulators. Internal protection circuitry includes reverse-battery protection, current limiting, thermal limiting, and reverse-current protection. The devices are available as an adjustable device with a 1.21-V reference voltage. The TPS73801 regulators are available in the 6-pin TO-223 (DCQ) packages.

ORDERING INFORMATION⁽¹⁾

T_A	V_{OUT} (TYP)	PACKAGE ⁽²⁾	ORDERABLE PART NUMBER	TOP-SIDE MARKING
-40°C to 125°C	Adjustable	TO-223 – DCQ Reel of 2500	TPS73801DCQR	PS73801

(1) For the most current package and ordering information, see the Package Option Addendum at the end of this document, or see the TI web site at www.ti.com.

(2) Package drawings, thermal data, and symbolization are available at www.ti.com/packaging.



Please be aware that an important notice concerning availability, standard warranty, and use in critical applications of Texas Instruments semiconductor products and disclaimers thereto appears at the end of this data sheet.

Table 1. TERMINAL FUNCTIONS

PIN		DESCRIPTION
NO.	NAME	
1	IN	Input. Power is supplied to the device through the IN pin. A bypass capacitor is required on this pin if the device is more than six inches away from the main input filter capacitor. In general, the output impedance of a battery rises with frequency, so it is advisable to include a bypass capacitor in battery-powered circuits. A bypass capacitor (ceramic) in the range of 1 μ F to 10 μ F is sufficient. The TPS73801 regulators are designed to withstand reverse voltages on the IN pin with respect to ground and the OUT pin. In the case of a reverse input, which can happen if a battery is plugged in backwards, the device acts as if there is a diode in series with its input. There is no reverse current flow into the regulator, and no reverse voltage appears at the load. The device protects both itself and the load.
2	OUT	Output. The output supplies power to the load. A minimum output capacitor (ceramic) of 10 μ F is required to prevent oscillations. Larger output capacitors are required for applications with large transient loads to limit peak voltage transients.
3	GND	Ground
4	FB	Feedback. This is the input to the error amplifier. This pin is internally clamped to ± 7 V. It has a bias current of 3 μ A that flows into the pin. The FB pin voltage is 1.21 V referenced to ground, and the output voltage range is 1.21 V to 20 V.
5	EN	Enable. The EN pin is used to put the TPS73801 regulators into a low-power shutdown state. The output is off when the EN pin is pulled low. The EN pin can be driven either by 5-V logic or open-collector gate, normally several microamperes, and the EN pin current, typically 3 μ A. If unused, the EN pin must be connected to the IN pin. The device is in the low-power shutdown state if the EN pin is not connected.
6	GND	Ground

ABSOLUTE MAXIMUM RATINGS⁽¹⁾

over operating free-air temperature range (unless otherwise noted)

V_{IN}	Input voltage range	IN	-20 V to 20 V
		OUT	-20 V to 20 V
		Input-to-output differential ⁽²⁾	-20 V to 20 V
		FB	-7 V to 7 V
		EN	-20 V to 20 V
t_{short}	Output short-circuit duration		Indefinite
T_J	Operating virtual-junction temperature range		-40°C to 125°C
T_{stg}	Storage temperature range		-65°C to 150°C

- (1) Stresses beyond those listed under "absolute maximum ratings" may cause permanent damage to the device. These are stress ratings only, and functional operation of the device at these or any other conditions beyond those indicated under "recommended operating conditions" is not implied. Exposure to absolute-maximum-rated conditions for extended periods may affect device reliability.
- (2) Absolute maximum input-to-output differential voltage cannot be achieved with all combinations of rated IN pin and OUT pin voltages. With the IN pin at 20 V, the OUT pin may not be pulled below 0 V. The total measured voltage from IN to OUT cannot exceed ± 20 V.

PACKAGE THERMAL DATA⁽¹⁾

PACKAGE	BOARD	θ_{JA}	θ_{JC}
TO-223 (DCQ)	Low K, JESD 51-5	53°C/W	15°C/W

- (1) Maximum power dissipation is a function of $T_J(\max)$, θ_{JA} , and T_A . The maximum allowable power dissipation at any allowable ambient temperature is $P_D = (T_J(\max) - T_A)/\theta_{JA}$. Operating at the absolute maximum T_J of 150°C can affect reliability.

ELECTRICAL CHARACTERISTICS⁽¹⁾

 Over operating temperature range $T_J = -40^{\circ}\text{C}$ to 125°C (unless otherwise noted)

PARAMETER	TEST CONDITIONS	T_J	MIN	TYP ⁽²⁾	MAX	UNIT	
V_{IN}	Input voltage ^{(3) (4)}	25°C	2.2	1.9	20	V	
V_{FB}	FB pin voltage ^{(3) (5)}	TPS73801	$V_{IN} = 2.21\text{ V}, I_{LOAD} = 1\text{ mA}$		25°C	1.192 1.21 1.228	V
			$V_{IN} = 2.5\text{ V to }20\text{ V}, I_{LOAD} = 1\text{ mA to }1.0\text{ A}$		Full range	1.174 1.21 1.246	
	Line regulation	TPS73801 ⁽³⁾	$\Delta V_{IN} = 2.21\text{ V to }20\text{ V}, I_{LOAD} = 1\text{ mA}$		Full range	1.5 5	mV
	Load regulation	TPS73801 ⁽³⁾	$V_{IN} = 2.5\text{ V}, \Delta I_{LOAD} = 1\text{ mA to }1.0\text{ A}$		25°C	2 8	mV
					Full range	18	
V_{DO}	Dropout voltage ^{(4) (6) (7)} $V_{IN} = V_{OUT(NOMINAL)}$	$I_{LOAD} = 1\text{ mA}$			25°C	0.02 0.06	V
					Full range	0.10	
		$I_{LOAD} = 100\text{ mA}$			25°C	0.1 0.17	
					Full range	0.22	
		$I_{LOAD} = 500\text{ mA}$			25°C	0.19 0.27	
					Full range	0.35	
$I_{LOAD} = 1.0\text{ A}$			25°C	0.24 0.30			
			Full range	0.40			
I_{GND}	GND pin current ^{(7) (8)} $V_{IN} = V_{OUT(NOMINAL)} + 1$	$I_{LOAD} = 0\text{ mA}$		Full range	1 1.5	mA	
		$I_{LOAD} = 1\text{ mA}$		Full range	1.1 1.6		
		$I_{LOAD} = 100\text{ mA}$		Full range	3.8 5.5		
		$I_{LOAD} = 500\text{ mA}$		Full range	15 25		
		$I_{LOAD} = 1.0\text{ A}$		Full range	35 80		
V_N	Output voltage noise	$C_{OUT} = 10\text{ }\mu\text{F}, I_{LOAD} = 1.0\text{ A}, B_W = 10\text{ Hz to }100\text{ kHz}$		25°C	45	μV_{RMS}	
I_{FB}	FB pin bias current ^{(3) (9)}			25°C	3 10	μA	
V_{EN}	Shutdown threshold	$V_{OUT} = \text{OFF to ON}$		Full range	0.9 2	V	
		$V_{OUT} = \text{ON to OFF}$		Full range	0.25 0.75		
I_{EN}	$\overline{\text{EN}}$ pin current	$V_{EN} = 0\text{ V}$		25°C	0.01 1	μA	
		$V_{EN} = 20\text{ V}$		25°C	3 30		
	Quiescent current in shutdown	$V_{IN} = 6\text{ V}, V_{EN} = 0\text{ V}$		25°C	0.01 1	μA	
PSRR	Ripple rejection	$V_{IN} - V_{OUT} = 1.5\text{ V (avg)}, V_{RIPPLE} = 0.5\text{ V}_{P-P}, f_{RIPPLE} = 120\text{ Hz}, I_{LOAD} = 0.75\text{ A}$		25°C	55 63	dB	
I_{CL}	Current limit	$V_{IN} = 7\text{ V}, V_{OUT} = 0\text{ V}$		25°C	2	A	
		$V_{IN} = V_{OUT(NOMINAL)} + 1$		Full range	1.6		
I_{REV}	Input reverse leakage current	$V_{IN} = -20\text{ V}, V_{OUT} = 0\text{ V}$		Full range	1	mA	

- (1) The TPS73801 regulators are tested and specified under pulse load conditions such that T_J is approximately equal to T_A . The TPS73801 is fully tested at $T_A = 25^{\circ}\text{C}$. Performance at -40°C and 125°C is specified by design, characterization, and correlation with statistical process controls.
- (2) Typical values represent the likely parametric nominal values determined at the time of characterization. Typical values depend on the application and configuration and may vary over time. Typical values are not ensured on production material.
- (3) The TPS73801 is tested and specified for these conditions with the FB pin connected to the OUT pin.
- (4) Dropout voltages are limited by the minimum input voltage specification under some output voltage/load conditions.
- (5) Operating conditions are limited by maximum junction temperature. The regulated output voltage specification does not apply for all possible combinations of input voltage and output current. When operating at maximum input voltage, the output current range must be limited. When operating at maximum output current, the input voltage range must be limited.
- (6) Dropout voltage is the minimum input to output voltage differential needed to maintain regulation at a specified output current. In dropout, the output voltage is equal to: $V_{IN} - V_{DROPOUT}$.
- (7) To satisfy requirements for minimum input voltage, the TPS73801 is tested and specified for these conditions with an external resistor divider (two 4.12-k Ω resistors) for an output voltage of 2.4 V. The external resistor divider adds a 300-mA DC load on the output.
- (8) GND pin current is tested with $V_{IN} = (V_{OUT(NOMINAL)} + 1\text{ V})$ and a current source load. The GND pin current decreases at higher input voltages.
- (9) FB pin bias current flows into the FB pin.

ELECTRICAL CHARACTERISTICS⁽¹⁾ (continued)Over operating temperature range $T_J = -40^{\circ}\text{C}$ to 125°C (unless otherwise noted)

PARAMETER		TEST CONDITIONS		T_J	MIN	TYP ⁽²⁾	MAX	UNIT
I_{RO}	Reverse output current ⁽¹⁰⁾	TPS73801	$V_{OUT} = 1.21\text{ V}, V_{IN} < 1.21\text{ V}$	25°C		300	600	μA

(10) Reverse output current is tested with the IN pin grounded and the OUT pin forced to the rated output voltage. This current flows into the OUT pin and out the GND pin.

TYPICAL CHARACTERISTICS

DROPOUT VOLTAGE vs OUTPUT CURRENT

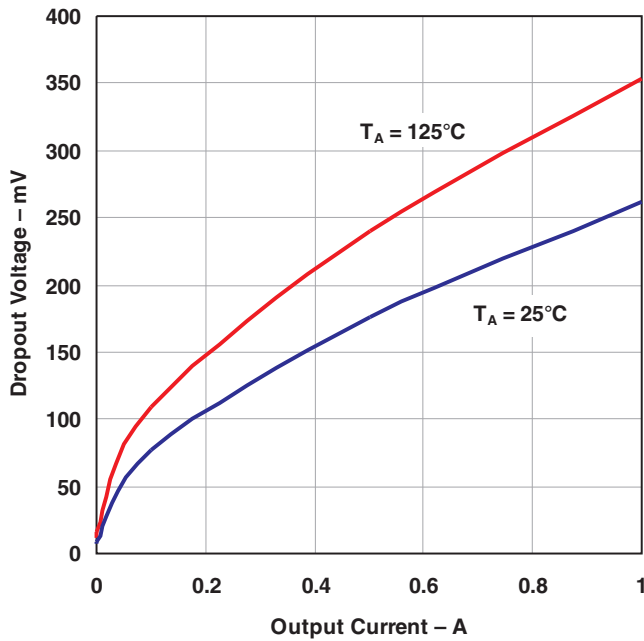

Figure 1.

DROPOUT VOLTAGE vs TEMPERATURE

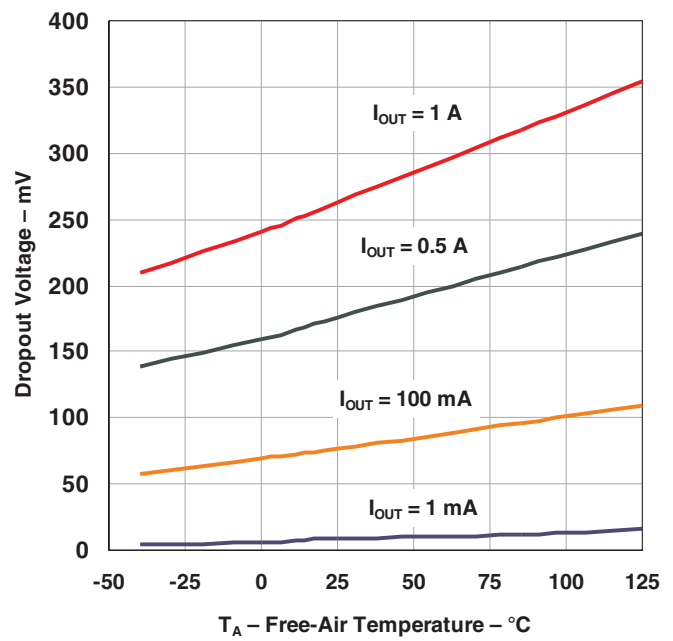

Figure 2.

QUIESCENT CURRENT vs TEMPERATURE

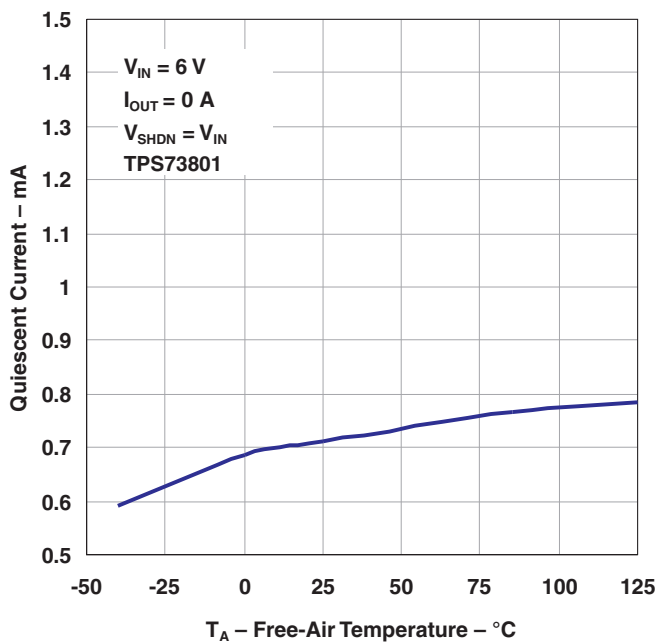

Figure 3.

OUTPUT VOLTAGE vs TEMPERATURE

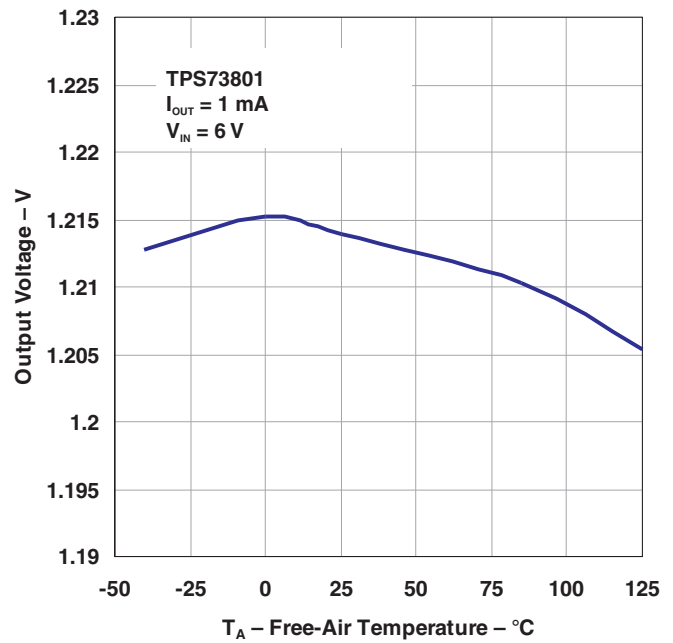

Figure 4.

TYPICAL CHARACTERISTICS (continued)

**QUIESCENT CURRENT
vs
INPUT VOLTAGE**

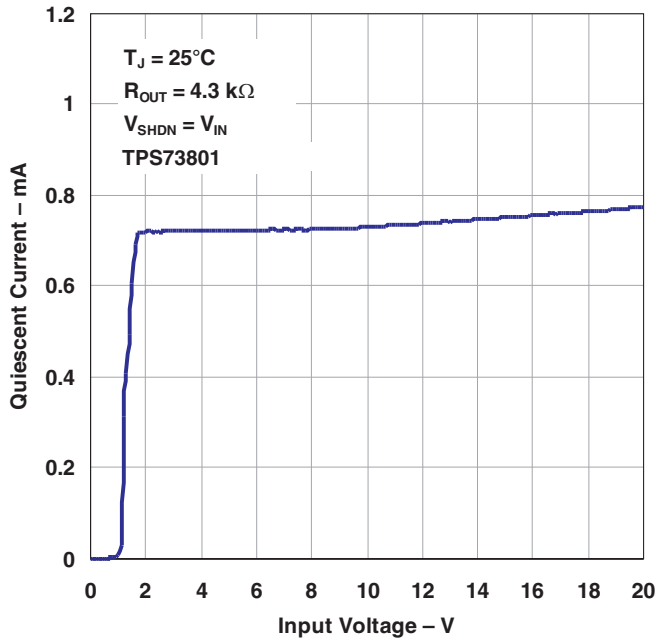

Figure 5.

**GROUND CURRENT
vs
INPUT VOLTAGE**

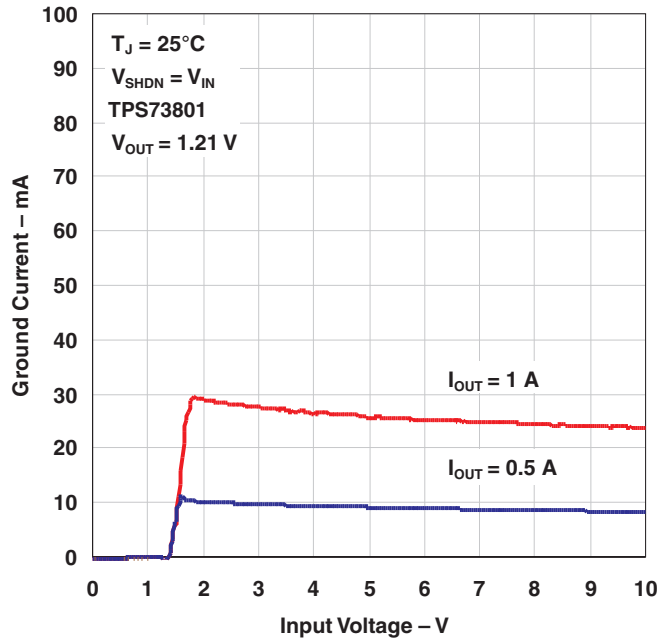

Figure 6.

**GROUND CURRENT
vs
INPUT VOLTAGE**

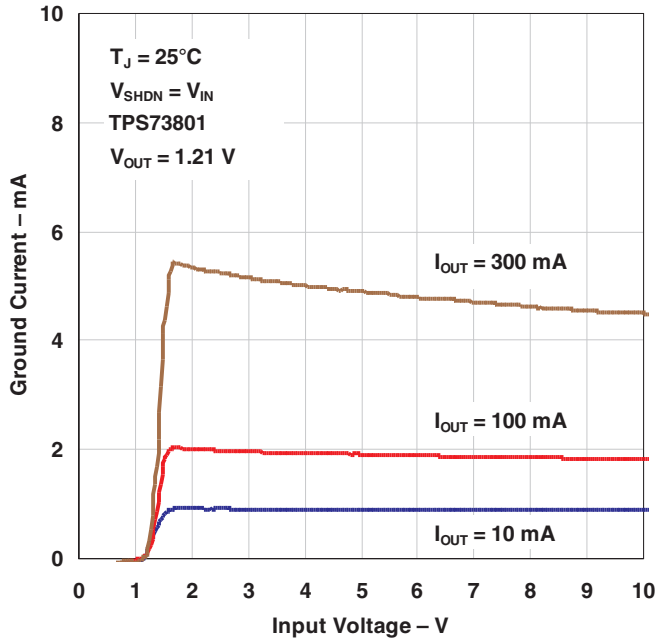

Figure 7.

**GROUND CURRENT
vs
OUTPUT CURRENT**

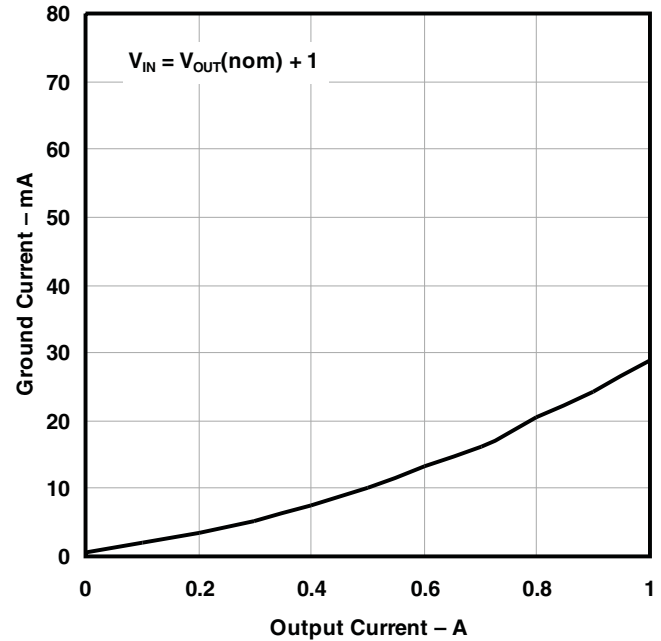

Figure 8.

TYPICAL CHARACTERISTICS (continued)

EN INPUT CURRENT
vs
TEMPERATURE

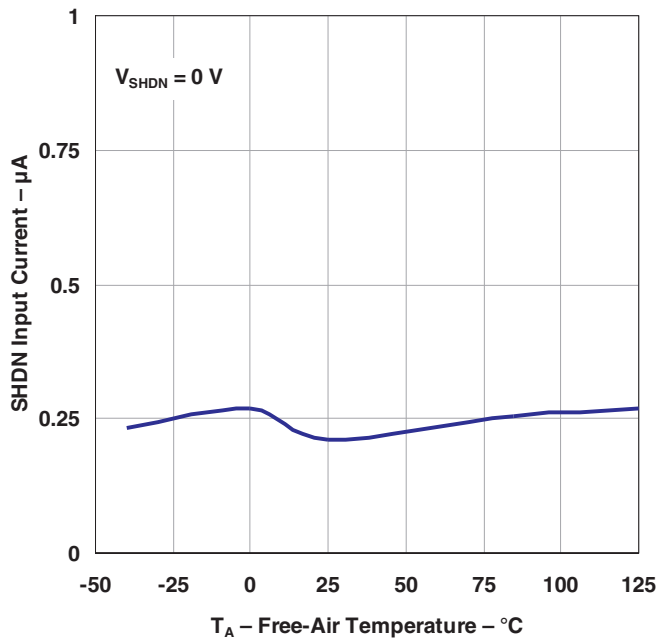

Figure 9.

EN INPUT CURRENT
vs
EN INPUT VOLTAGE

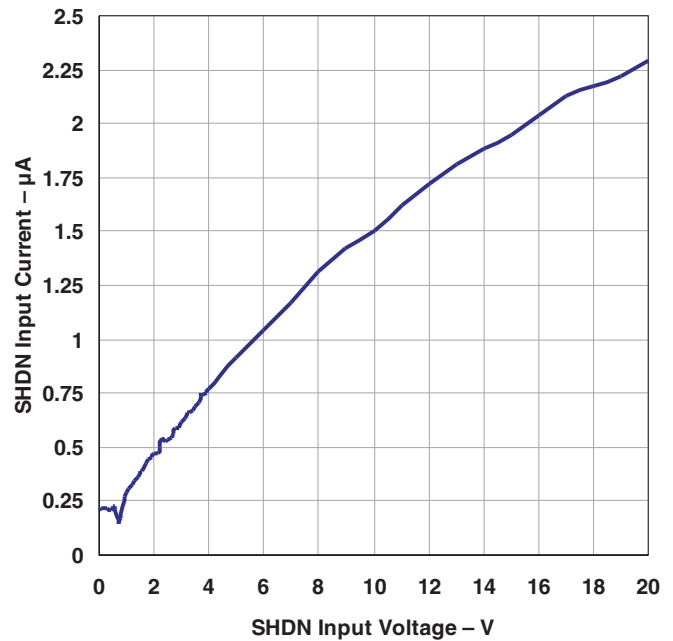

Figure 10.

EN THRESHOLD (OFF TO ON)
vs
TEMPERATURE

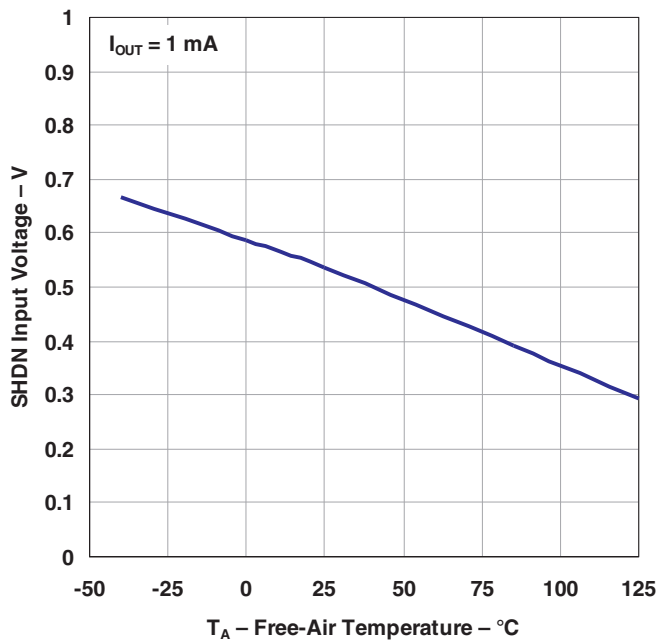

Figure 11.

EN THRESHOLD (ON TO OFF)
vs
TEMPERATURE

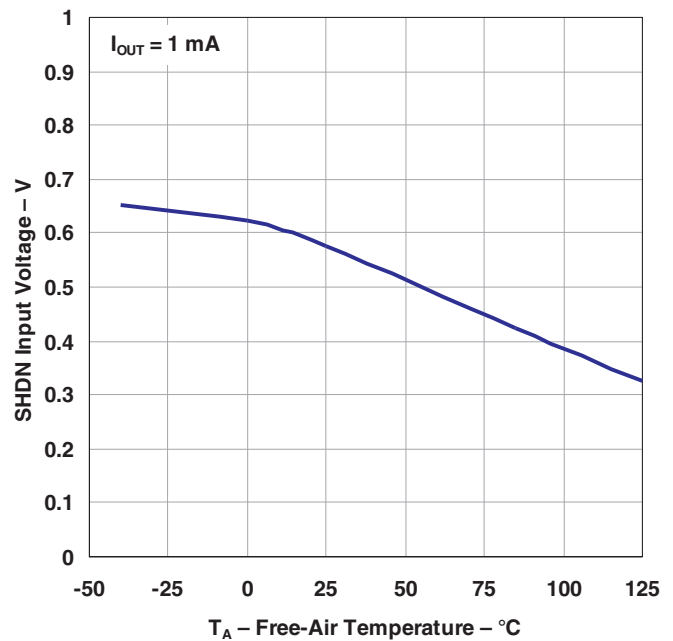

Figure 12.

TYPICAL CHARACTERISTICS (continued)

**FB BIAS CURRENT
vs
TEMPERATURE**

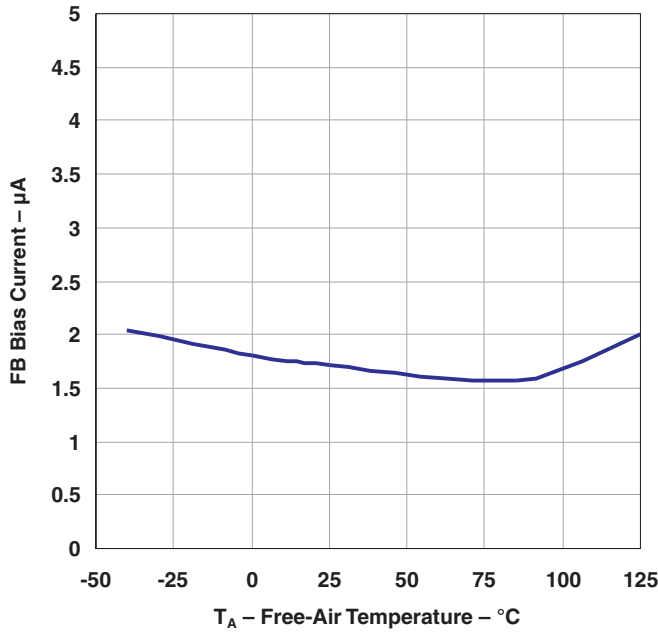

Figure 13.

**CURRENT LIMIT
vs
INPUT/OUTPUT DIFFERENTIAL VOLTAGE**

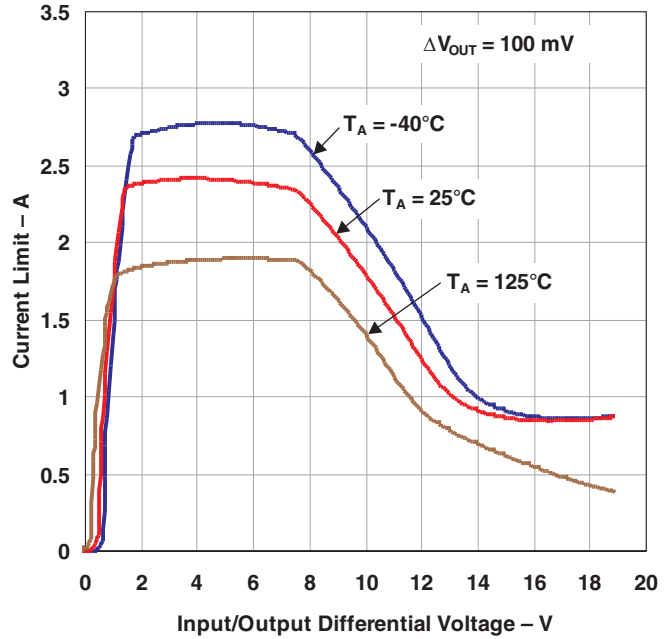

Figure 14.

**CURRENT LIMIT
vs
TEMPERATURE**

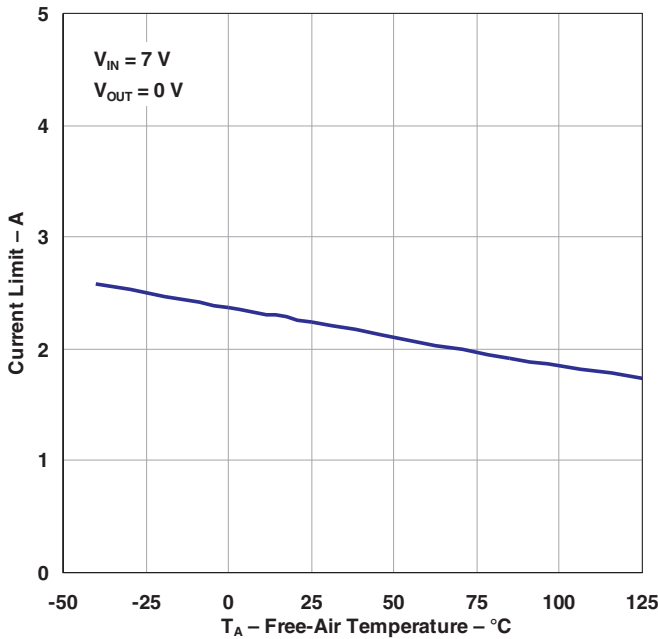

Figure 15.

**REVERSE OUTPUT CURRENT
vs
OUTPUT VOLTAGE**

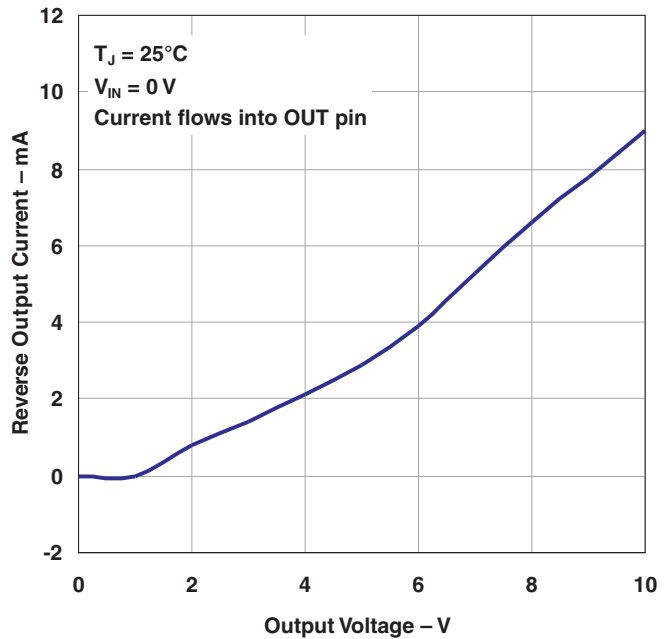

Figure 16.

TYPICAL CHARACTERISTICS (continued)

REVERSE OUTPUT CURRENT
vs
TEMPERATURE

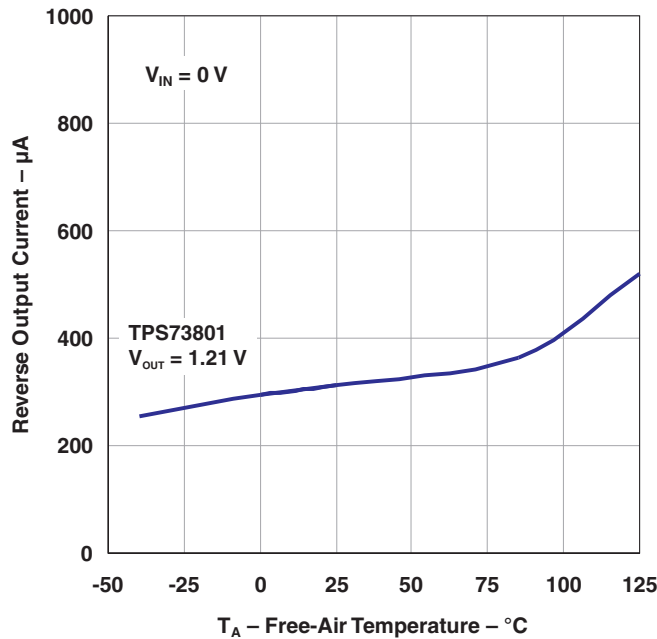

Figure 17.

RIPPLE REJECTION
vs
FREQUENCY

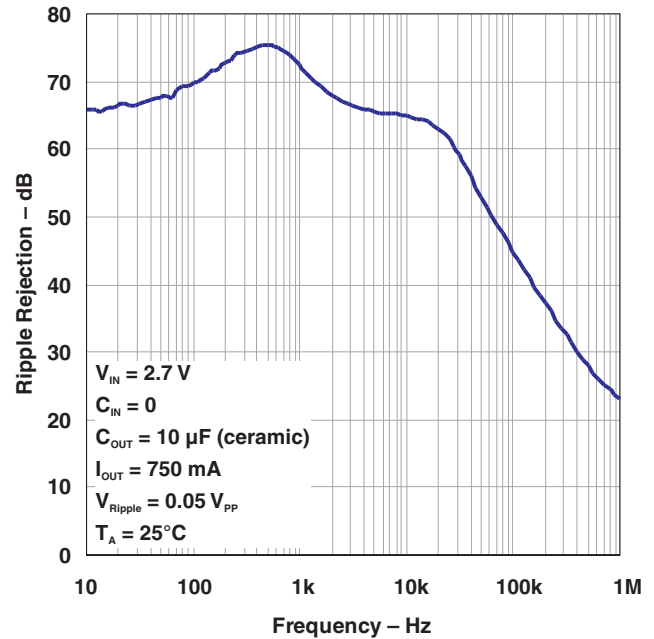

Figure 18.

LOAD REGULATION
vs
TEMPERATURE

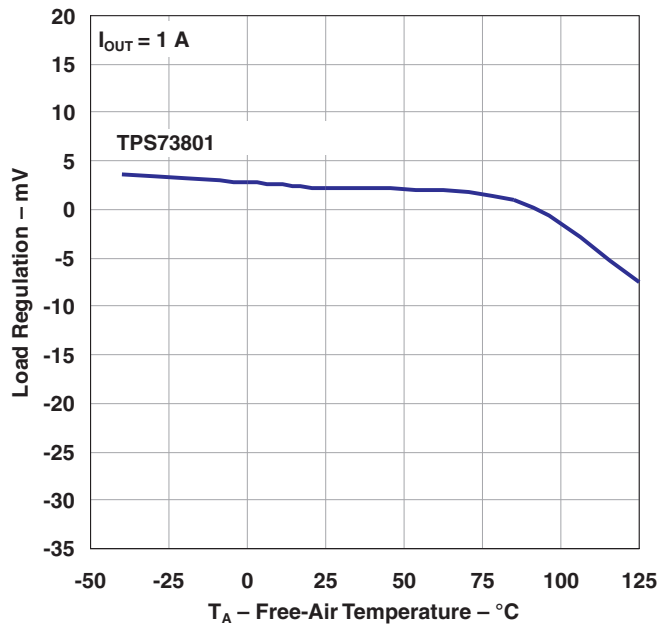

Figure 19.

OUTPUT NOISE VOLTAGE
vs
FREQUENCY

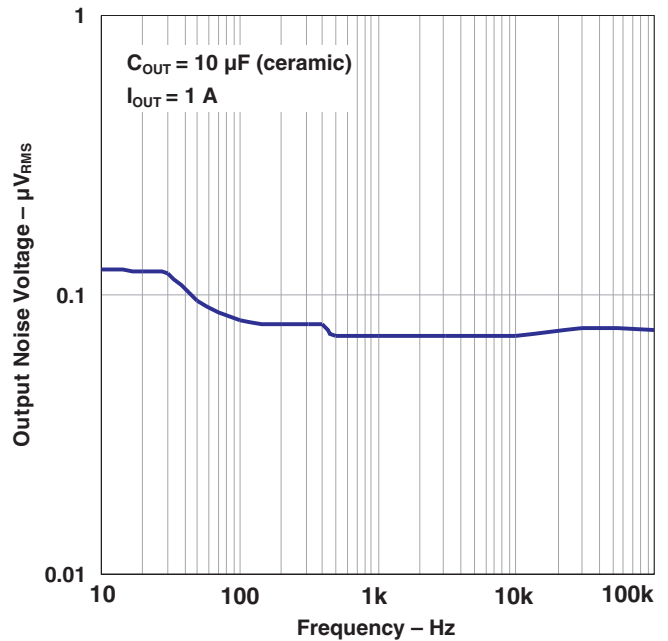
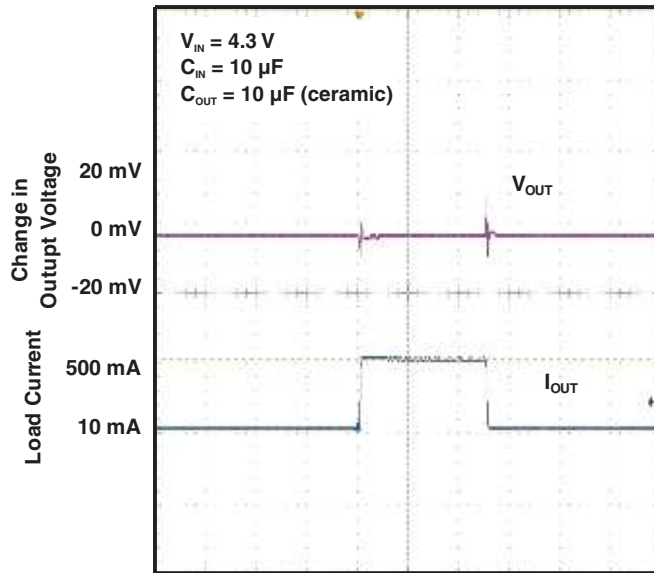

Figure 20.

TYPICAL CHARACTERISTICS (continued)

LOAD TRANSIENT RESPONSE



500 μs per division

Figure 21.

LOAD TRANSIENT RESPONSE

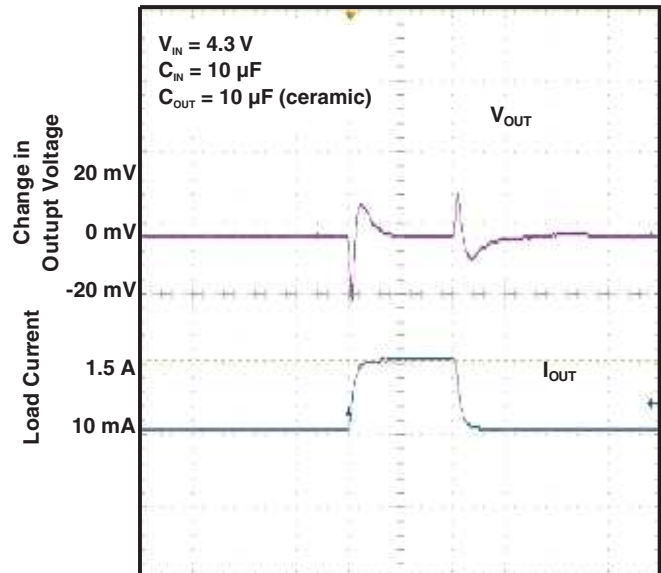

500 μs per division

Figure 22.

APPLICATION INFORMATION

The TPS73801 is a 1.0-A LDO regulator optimized for fast transient response. The devices are capable of supplying 1.0 A at a dropout voltage of 300 mV. The low operating quiescent current (1 mA) drops to less than 1 μ A in shutdown. In addition to the low quiescent current, the TPS73801 regulators incorporate several protection features which make them ideal for use in battery-powered systems. The devices are protected against both reverse input and reverse output voltages. In battery-backup applications where the output can be held up by a backup battery when the input is pulled to ground, the TPS73801 acts as if it has a diode in series with its output and prevents reverse current flow. Additionally, in dual-supply applications where the regulator load is returned to a negative supply, the output can be pulled below ground by as much as 20 V and still allow the device to start and operate.

Typical Applications

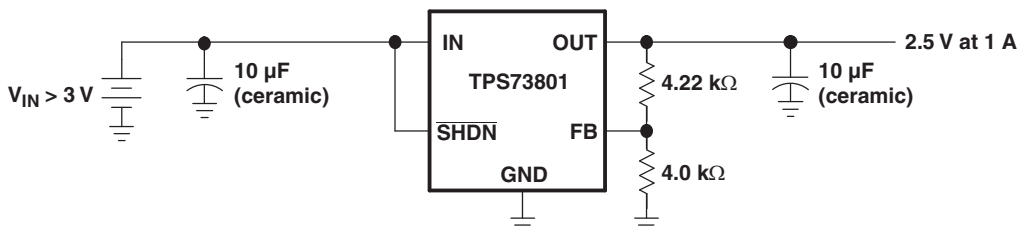

Figure 24. 3.3 V to 2.5 V Regulator

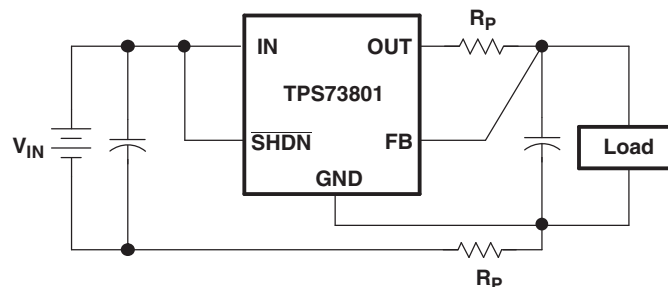
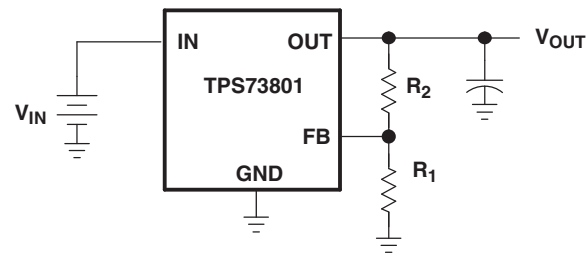

Figure 25. Kelvin Sense Connection

Adjustable Operation

The TPS73801 has an output voltage range of 1.21 V to 20 V. The output voltage is set by the ratio of two external resistors as shown in Figure 26. The device maintains the voltage at the FB pin at 1.21 V referenced to ground. The current in R1 is then equal to $1.21 \text{ V} / R_1$, and the current in R2 is the current in R1 plus the FB pin bias current. The FB pin bias current, 3 μ A at 25°C, flows through R2 into the FB pin. The output voltage can be calculated using the formula shown in Figure 26. The value of R1 should be less than 4.17 k Ω to minimize errors in the output voltage caused by the FB pin bias current. Note that in shutdown the output is turned off, and the divider current is zero.



$$V_{OUT} = 1.21 \text{ V} \left(1 + \frac{R_2}{R_1} \right) + (I_{FB})(R_2)$$

$$V_{FB} = 1.21 \text{ V}$$

$$I_{FB} = 3 \mu\text{A at } 25^\circ\text{C}$$

$$\text{Output range} = 1.21 \text{ V to } 20 \text{ V}$$

Figure 26. Adjustable Operation

The TPS73801 is tested and specified with the FB pin tied to the OUT pin for an output voltage of 1.21 V. Specifications for output voltages greater than 1.21 V are proportional to the ratio of the desired output voltage to 1.21 V: $V_{OUT}/1.21 \text{ V}$. For example, load regulation for an output current change of 1 mA to 1.0 A is -3 mV (typ) at $V_{OUT} = 1.21 \text{ V}$. At $V_{OUT} = 5 \text{ V}$, load regulation is:

$$(5 \text{ V}/1.21 \text{ V})(-3 \text{ mV}) = -12.4 \text{ mV}$$

Output Capacitance and Transient Response

The TPS73801 regulators are designed to be stable with a wide range of output capacitors. The ESR of the output capacitor affects stability, most notably with small capacitors. A minimum output capacitor of $10 \mu\text{F}$ with an ESR of 3Ω or less is recommended to prevent oscillations. Larger values of output capacitance can decrease the peak deviations and provide improved transient response for larger load current changes. Bypass capacitors, used to decouple individual components powered by the TPS73801, increase the effective output capacitor value.

Extra consideration must be given to the use of ceramic capacitors. Ceramic capacitors are manufactured with a variety of dielectrics, each with different behavior over temperature and applied voltage. The most common dielectrics used are Z5U, Y5V, X5R and X7R. The Z5U and Y5V dielectrics are good for providing high capacitances in a small package, but exhibit strong voltage and temperature coefficients. When used with a 5-V regulator, a $10\text{-}\mu\text{F}$ Y5V capacitor can exhibit an effective value as low as $1 \mu\text{F}$ to $2 \mu\text{F}$ over the operating temperature range. The X5R and X7R dielectrics result in more stable characteristics and are more suitable for use as the output capacitor. The X7R type has better stability across temperature, while the X5R is less expensive and is available in higher values.

Voltage and temperature coefficients are not the only sources of problems. Some ceramic capacitors have a piezoelectric response. A piezoelectric device generates voltage across its terminals due to mechanical stress, similar to the way a piezoelectric accelerometer or microphone works. For a ceramic capacitor the stress can be induced by vibrations in the system or thermal transients.

Overload Recovery

Like many IC power regulators, the TPS73801 has safe operating area protection. The safe area protection decreases the current limit as input-to-output voltage increases and keeps the power transistor inside a safe operating region for all values of input-to-output voltage. The protection is designed to provide some output current at all values of input-to-output voltage up to the device breakdown.

When power is first turned on, as the input voltage rises, the output follows the input, allowing the regulator to start up into very heavy loads. During start up, as the input voltage is rising, the input-to-output voltage differential is small, allowing the regulator to supply large output currents. With a high input voltage, a problem can occur wherein removal of an output short does not allow the output voltage to recover. Other regulators also exhibit this phenomenon, so it is not unique to the TPS73801.

The problem occurs with a heavy output load when the input voltage is high and the output voltage is low. Common situations are immediately after the removal of a short circuit or when the shutdown pin is pulled high after the input voltage has already been turned on. The load line for such a load may intersect the output current curve at two points. If this happens, there are two stable output operating points for the regulator. With this double intersection, the input power supply may need to be cycled down to zero and brought up again to make the output recover.

Output Voltage Noise

The TPS73801 regulators have been designed to provide low output voltage noise over the 10-Hz to 100-kHz bandwidth while operating at full load. Output voltage noise is typically 40 nV/ $\sqrt{\text{Hz}}$ over this frequency bandwidth for the TPS73801. For higher output voltages (generated by using a resistor divider), the output voltage noise is gained up accordingly. This results in RMS noise over the 10-Hz to 100-kHz bandwidth of 14 μV_{RMS} for the TPS73801.

Higher values of output voltage noise may be measured when care is not exercised with regards to circuit layout and testing. Crosstalk from nearby traces can induce unwanted noise onto the output of the TPS73801. Power-supply ripple rejection must also be considered; the TPS73801 regulators do not have unlimited power-supply rejection and pass a small portion of the input noise through to the output.

Thermal Considerations

The power handling capability of the device is limited by the maximum rated junction temperature (125°C). The power dissipated by the device is made up of two components:

1. Output current multiplied by the input/output voltage differential: $I_{\text{OUT}}(V_{\text{IN}} - V_{\text{OUT}})$
2. GND pin current multiplied by the input voltage: $I_{\text{GND}}V_{\text{IN}}$.

The GND pin current can be found using the GND Pin Current graphs in *Typical Characteristics*. Power dissipation is equal to the sum of the two components listed above.

The TPS73801 regulators have internal thermal limiting designed to protect the device during overload conditions. For continuous normal conditions, the maximum junction temperature rating of 125°C must not be exceeded. It is important to give careful consideration to all sources of thermal resistance from junction to ambient. Additional heat sources mounted nearby must also be considered.

For surface-mount devices, heat sinking is accomplished by using the heat-spreading capabilities of the PC board and its copper traces. Copper board stiffeners and plated through-holes also can be used to spread the heat generated by power devices.

Calculating Junction Temperature

Example: Given an output voltage of 3.3 V, an input voltage range of 4 V to 6 V, an output current range of 0 mA to 500 mA, and a maximum ambient temperature of 50°C, what is the maximum junction temperature?

The power dissipated by the device is equal to:

$$I_{OUT(MAX)}(V_{IN(MAX)} - V_{OUT}) + I_{GND}(V_{IN(MAX)})$$

where,

$$I_{OUT(MAX)} = 500 \text{ mA}$$

$$V_{IN(MAX)} = 5 \text{ V}$$

$$I_{GND} \text{ at } (I_{OUT} = 500 \text{ mA}, V_{IN} = 5 \text{ V}) = 10 \text{ mA}$$

So,

$$P = 500 \text{ mA } (5 \text{ V} - 3.3 \text{ V}) + 10 \text{ mA } (5 \text{ V}) = 0.9 \text{ W}$$

Using a DCQ package, the thermal resistance is about 53°C/W, depending on the copper area. So the junction temperature rise above ambient is approximately equal to:

$$0.9 \text{ W} \times 53^\circ\text{C/W} = 47.7^\circ\text{C}$$

The maximum junction temperature is then equal to the maximum junction-temperature rise above ambient plus the maximum ambient temperature or:

$$T_{JMAX} = 50^\circ\text{C} + 47.7^\circ\text{C} = 97.7^\circ\text{C}$$

Protection Features

The TPS73801 regulators incorporate several protection features that make them ideal for use in battery-powered circuits. In addition to the normal protection features associated with monolithic regulators, such as current limiting and thermal limiting, the devices are protected against reverse input voltages, reverse output voltages and reverse voltages from output to input.

Current limit protection and thermal overload protection are intended to protect the device against current overload conditions at the output of the device. For normal operation, the junction temperature should not exceed 125°C.

The input of the device withstands reverse voltages of 20 V. Current flow into the device is limited to less than 1 mA (typically less than 100 µA), and no negative voltage appears at the output. The device protects both itself and the load. This provides protection against batteries that can be plugged in backward.

The output of the TPS73801 can be pulled below ground without damaging the device. If the input is left open circuit or grounded, the output can be pulled below ground by 20 V. The output acts like an open circuit; no current flows out of the pin. If the input is powered by a voltage source, the output sources the short-circuit current of the device and protects itself by thermal limiting. In this case, grounding the EN pin turns off the device and stops the output from sourcing the short-circuit current.

The FB pin can be pulled above or below ground by as much as 7 V without damaging the device. If the input is left open circuit or grounded, the FB pin acts like an open circuit when pulled below ground and like a large resistor (typically 5 kΩ) in series with a diode when pulled above ground.

In situations where the FB pin is connected to a resistor divider that would pull the FB pin above its 7-V clamp voltage if the output is pulled high, the FB pin input current must be limited to less than 5 mA. For example, a resistor divider is used to provide a regulated 1.5-V output from the 1.21-V reference when the output is forced to 20 V. The top resistor of the resistor divider must be chosen to limit the current into the FB pin to less than 5 mA when the FB pin is at 7 V. The 13-V difference between OUT and FB pins divided by the 5-mA maximum current into the FB pin yields a minimum top resistor value of 2.6 kΩ.

In circuits where a backup battery is required, several different input/output conditions can occur. The output voltage may be held up while the input is either pulled to ground, pulled to some intermediate voltage, or is left open circuit.

When the IN pin of the TPS73801 is forced below the OUT pin or the OUT pin is pulled above the IN pin, input current typically drops to less than 2 µA. This can happen if the input of the device is connected to a discharged (low voltage) battery and the output is held up by either a backup battery or a second regulator circuit. The state of the EN pin has no effect on the reverse output current when the output is pulled above the input.

REVISION HISTORY

Changes from Original (February 2010) to Revision A	Page
• Updated the TOP-SIDE MARKING in the ORDERING INFORMATION TABLE.	1

PACKAGING INFORMATION

Orderable Device	Status ⁽¹⁾	Package Type	Package Drawing	Pins	Package Qty	Eco Plan ⁽²⁾	Lead/ Ball Finish	MSL Peak Temp ⁽³⁾	Samples (Requires Login)
TPS73801DCQR	ACTIVE	SOT-223	DCQ	6	2500	Green (RoHS & no Sb/Br)	CU NIPDAU	Level-2-260C-1 YEAR	

⁽¹⁾ The marketing status values are defined as follows:

ACTIVE: Product device recommended for new designs.

LIFEBUY: TI has announced that the device will be discontinued, and a lifetime-buy period is in effect.

NRND: Not recommended for new designs. Device is in production to support existing customers, but TI does not recommend using this part in a new design.

PREVIEW: Device has been announced but is not in production. Samples may or may not be available.

OBSOLETE: TI has discontinued the production of the device.

⁽²⁾ Eco Plan - The planned eco-friendly classification: Pb-Free (RoHS), Pb-Free (RoHS Exempt), or Green (RoHS & no Sb/Br) - please check <http://www.ti.com/productcontent> for the latest availability information and additional product content details.

TBD: The Pb-Free/Green conversion plan has not been defined.

Pb-Free (RoHS): TI's terms "Lead-Free" or "Pb-Free" mean semiconductor products that are compatible with the current RoHS requirements for all 6 substances, including the requirement that lead not exceed 0.1% by weight in homogeneous materials. Where designed to be soldered at high temperatures, TI Pb-Free products are suitable for use in specified lead-free processes.

Pb-Free (RoHS Exempt): This component has a RoHS exemption for either 1) lead-based flip-chip solder bumps used between the die and package, or 2) lead-based die adhesive used between the die and leadframe. The component is otherwise considered Pb-Free (RoHS compatible) as defined above.

Green (RoHS & no Sb/Br): TI defines "Green" to mean Pb-Free (RoHS compatible), and free of Bromine (Br) and Antimony (Sb) based flame retardants (Br or Sb do not exceed 0.1% by weight in homogeneous material)

⁽³⁾ MSL, Peak Temp. -- The Moisture Sensitivity Level rating according to the JEDEC industry standard classifications, and peak solder temperature.

Important Information and Disclaimer: The information provided on this page represents TI's knowledge and belief as of the date that it is provided. TI bases its knowledge and belief on information provided by third parties, and makes no representation or warranty as to the accuracy of such information. Efforts are underway to better integrate information from third parties. TI has taken and continues to take reasonable steps to provide representative and accurate information but may not have conducted destructive testing or chemical analysis on incoming materials and chemicals. TI and TI suppliers consider certain information to be proprietary, and thus CAS numbers and other limited information may not be available for release.

In no event shall TI's liability arising out of such information exceed the total purchase price of the TI part(s) at issue in this document sold by TI to Customer on an annual basis.

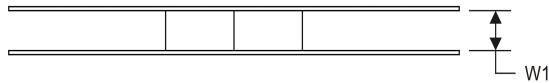
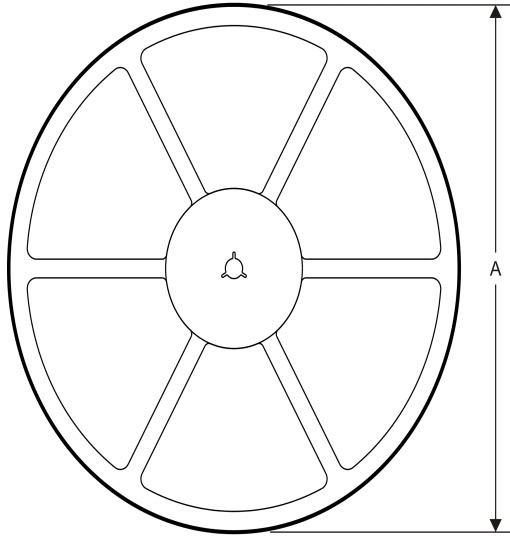
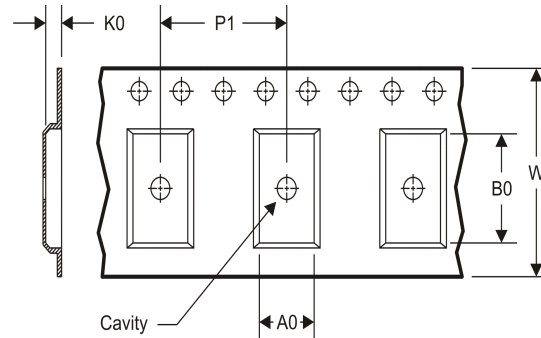
TAPE AND REEL INFORMATION
REEL DIMENSIONS

TAPE DIMENSIONS

A0	Dimension designed to accommodate the component width
B0	Dimension designed to accommodate the component length
K0	Dimension designed to accommodate the component thickness
W	Overall width of the carrier tape
P1	Pitch between successive cavity centers

TAPE AND REEL INFORMATION

*All dimensions are nominal

Device	Package Type	Package Drawing	Pins	SPQ	Reel Diameter (mm)	Reel Width W1 (mm)	A0 (mm)	B0 (mm)	K0 (mm)	P1 (mm)	W (mm)	Pin1 Quadrant
TPS73801DCQR	SOT-223	DCQ	6	2500	330.0	12.4	7.05	7.45	1.88	8.0	12.0	Q3

TAPE AND REEL BOX DIMENSIONS



*All dimensions are nominal

Device	Package Type	Package Drawing	Pins	SPQ	Length (mm)	Width (mm)	Height (mm)
TPS73801DCQR	SOT-223	DCQ	6	2500	358.0	335.0	35.0

DCQ (R-PDSO-G6)

PLASTIC SMALL-OUTLINE

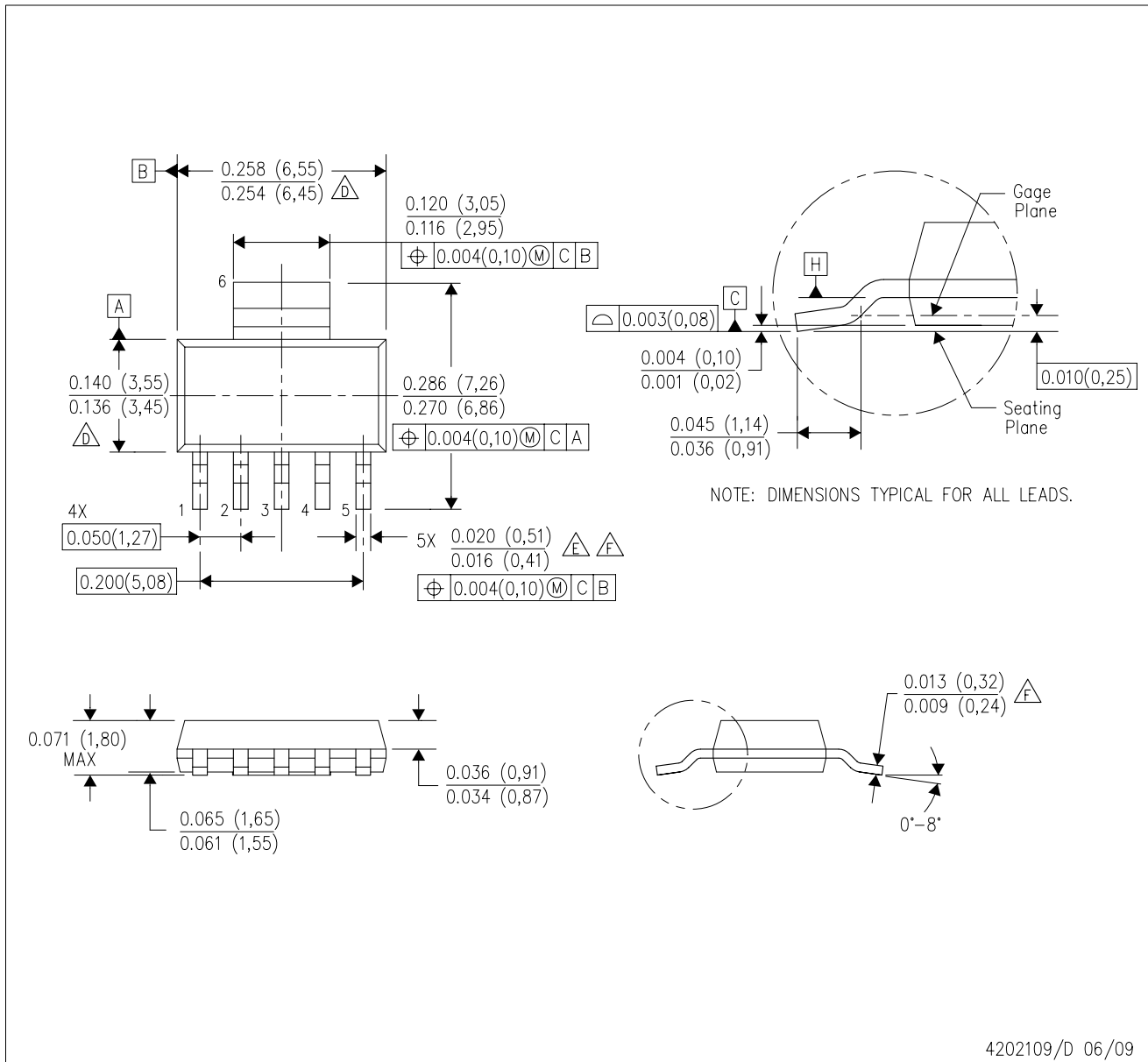

4202109/D 06/09

- NOTES:
- A. All linear dimensions are in inches (millimeters).
 - B. This drawing is subject to change without notice.
 - C. Controlling dimension in inches.
 - $\triangle D$ Body length and width dimensions are determined at the outermost extremes of the plastic body exclusive of mold flash, tie bar burrs, gate burrs, and interlead flash, but including any mismatch between the top and the bottom of the plastic body.
 - $\triangle E$ Lead width dimension does not include dambar protrusion.
 - $\triangle F$ Lead width and thickness dimensions apply to solder plated leads.
 - G. Interlead flash allow 0.008 inch max.
 - H. Gate burr/protrusion max. 0.006 inch.
 - I. Datums A and B are to be determined at Datum H.

DCQ (R-PDSO-G6)

PLASTIC SMALL OUTLINE

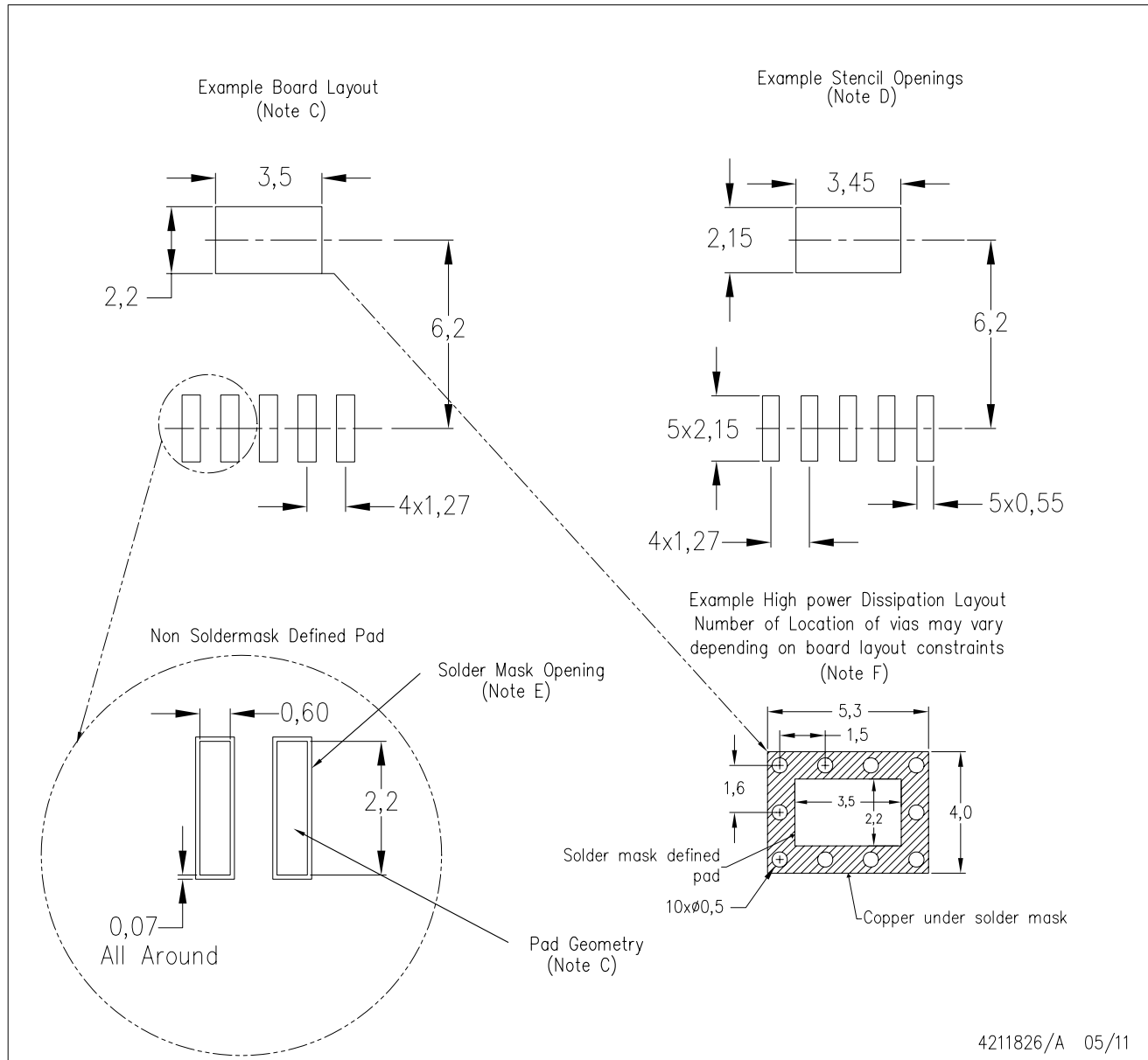

- NOTES:
- All linear dimensions are in millimeters.
 - This drawing is subject to change without notice.
 - Publication IPC-SM-782 is recommended for alternate designs.
 - Laser cutting apertures with trapezoidal walls and also rounding corners will offer better paste release. Customers should contact their board assembly site for stencil design recommendations.
 - Customers should contact their board fabrication site for solder mask tolerances between and around signal pads.
 - Please refer to the product data sheet for specific via and thermal dissipation requirements.

IMPORTANT NOTICE

Texas Instruments Incorporated and its subsidiaries (TI) reserve the right to make corrections, enhancements, improvements and other changes to its semiconductor products and services per JESD46C and to discontinue any product or service per JESD48B. Buyers should obtain the latest relevant information before placing orders and should verify that such information is current and complete. All semiconductor products (also referred to herein as "components") are sold subject to TI's terms and conditions of sale supplied at the time of order acknowledgment.

TI warrants performance of its components to the specifications applicable at the time of sale, in accordance with the warranty in TI's terms and conditions of sale of semiconductor products. Testing and other quality control techniques are used to the extent TI deems necessary to support this warranty. Except where mandated by applicable law, testing of all parameters of each component is not necessarily performed.

TI assumes no liability for applications assistance or the design of Buyers' products. Buyers are responsible for their products and applications using TI components. To minimize the risks associated with Buyers' products and applications, Buyers should provide adequate design and operating safeguards.

TI does not warrant or represent that any license, either express or implied, is granted under any patent right, copyright, mask work right, or other intellectual property right relating to any combination, machine, or process in which TI components or services are used. Information published by TI regarding third-party products or services does not constitute a license to use such products or services or a warranty or endorsement thereof. Use of such information may require a license from a third party under the patents or other intellectual property of the third party, or a license from TI under the patents or other intellectual property of TI.

Reproduction of significant portions of TI information in TI data books or data sheets is permissible only if reproduction is without alteration and is accompanied by all associated warranties, conditions, limitations, and notices. TI is not responsible or liable for such altered documentation. Information of third parties may be subject to additional restrictions.

Resale of TI components or services with statements different from or beyond the parameters stated by TI for that component or service voids all express and any implied warranties for the associated TI component or service and is an unfair and deceptive business practice. TI is not responsible or liable for any such statements.

Buyer acknowledges and agrees that it is solely responsible for compliance with all legal, regulatory and safety-related requirements concerning its products, and any use of TI components in its applications, notwithstanding any applications-related information or support that may be provided by TI. Buyer represents and agrees that it has all the necessary expertise to create and implement safeguards which anticipate dangerous consequences of failures, monitor failures and their consequences, lessen the likelihood of failures that might cause harm and take appropriate remedial actions. Buyer will fully indemnify TI and its representatives against any damages arising out of the use of any TI components in safety-critical applications.

In some cases, TI components may be promoted specifically to facilitate safety-related applications. With such components, TI's goal is to help enable customers to design and create their own end-product solutions that meet applicable functional safety standards and requirements. Nonetheless, such components are subject to these terms.

No TI components are authorized for use in FDA Class III (or similar life-critical medical equipment) unless authorized officers of the parties have executed a special agreement specifically governing such use.

Only those TI components which TI has specifically designated as military grade or "enhanced plastic" are designed and intended for use in military/aerospace applications or environments. Buyer acknowledges and agrees that any military or aerospace use of TI components which have **not** been so designated is solely at the Buyer's risk, and that Buyer is solely responsible for compliance with all legal and regulatory requirements in connection with such use.

TI has specifically designated certain components which meet ISO/TS16949 requirements, mainly for automotive use. Components which have not been so designated are neither designed nor intended for automotive use; and TI will not be responsible for any failure of such components to meet such requirements.

Products

Audio	www.ti.com/audio
Amplifiers	amplifier.ti.com
Data Converters	dataconverter.ti.com
DLP® Products	www.dlp.com
DSP	dsp.ti.com
Clocks and Timers	www.ti.com/clocks
Interface	interface.ti.com
Logic	logic.ti.com
Power Mgmt	power.ti.com
Microcontrollers	microcontroller.ti.com
RFID	www.ti-rfid.com
OMAP Mobile Processors	www.ti.com/omap
Wireless Connectivity	www.ti.com/wirelessconnectivity

Applications

Automotive and Transportation	www.ti.com/automotive
Communications and Telecom	www.ti.com/communications
Computers and Peripherals	www.ti.com/computers
Consumer Electronics	www.ti.com/consumer-apps
Energy and Lighting	www.ti.com/energy
Industrial	www.ti.com/industrial
Medical	www.ti.com/medical
Security	www.ti.com/security
Space, Avionics and Defense	www.ti.com/space-avionics-defense
Video and Imaging	www.ti.com/video

TI E2E Community e2e.ti.com