

200-mA Low-Noise, High-PSRR, Negative-Output, Low-Dropout Linear Regulators

Check for Samples: [TPS72301-Q1](#), [TPS72325-Q1](#)

FEATURES

- Qualified for Automotive Applications
- Ultralow Noise: 60 μV_{RMS} Typical
- High PSRR: 65 dB Typical at 1kHz
- Low Dropout Voltage: 280 mV Typical at 200 mA, 2.5 V
- Available in -2.5 V and Adjustable (-1.2 V to -10 V) Versions
- Stable With a 2.2- μF Ceramic Output Capacitor
- Less Than 2- μA Typical Quiescent Current in Shutdown Mode
- 2% Overall Accuracy (Line, Load, Temperature)
- Thermal and Overcurrent Protection
- SOT23-5 (DBV) Package
- Operating Junction Temperature Range: -40°C to 125°C

APPLICATIONS

- Optical Drives
- Optical Networking
- Noise-Sensitive Circuitry
- GaAs FET Gate Bias
- Video Amplifiers

DESCRIPTION

The TPS723xx-Q1 family of low-dropout (LDO) negative voltage regulators offers an ideal combination of features to support low-noise applications. This device is capable of operating with input voltages from -10 V to -2.7 V . The TPS72325-Q1 regulator is stable with small, low-cost ceramic capacitors, and includes enable (EN) and noise-reduction (NR) functions. Internal detection and shutdown logic provide thermal short-circuit and overcurrent protection. High PSRR (65 dB at 1 kHz) and low noise (60 μV_{RMS}) make the TPS723xx-Q1 ideal for low-noise applications.

The TPS723xx-Q1 uses a precision voltage reference to achieve 2% overall accuracy over load, line, and temperature variations. Available in a small SOT23-5 package, the TPS723xx-Q1 specification covers the full temperature range of -40°C to 125°C .

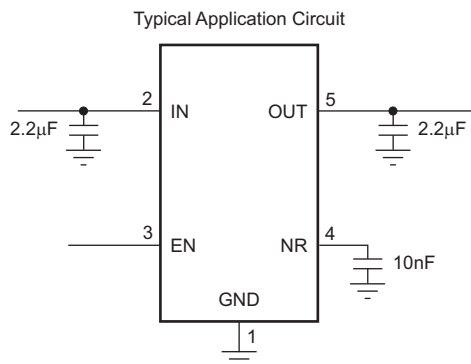

Please be aware that an important notice concerning availability, standard warranty, and use in critical applications of Texas Instruments semiconductor products and disclaimers thereto appears at the end of this data sheet.

All trademarks are the property of their respective owners.



This integrated circuit can be damaged by ESD. Texas Instruments recommends that all integrated circuits be handled with appropriate precautions. Failure to observe proper handling and installation procedures can cause damage.

ESD damage can range from subtle performance degradation to complete device failure. Precision integrated circuits may be more susceptible to damage because very small parametric changes could cause the device not to meet its published specifications.

ORDERING INFORMATION^{(1) (2)}

PRODUCT	V _{OUT} ⁽²⁾	TOP-SIDE MARKING
TPS72301QDBVRQ1	Adjustable output voltage	PPHQ
TPS72325QDBVRQ1	Nominal output voltage = 2.5 V	PSBQ

- (1) For the most current package and ordering information, see the Package Option Addendum at the end of this document, or see the TI Web site at www.ti.com.
- (2) Output voltages from –1.2 V to –9 V in 100-mV increments are available. Minimum order quantities apply; contact factory for details and availability.

ABSOLUTE MAXIMUM RATINGS^{(1) (2)}

Over operating temperature range, unless otherwise noted.

	VALUE	UNITS
Input voltage range, V _{IN}	–11 to 0.3	V
Noise reduction pin voltage range, V _{NR}	–11 to 5.5	V
Enable voltage range, V _{EN}	–V _{IN} to 5.5	V
Output current, I _{OUT}	Internally limited	
Output short-circuit duration	Indefinite	
Continuous total power dissipation, P _D	See Power Dissipation Ratings table	
Junction temperature range, T _J	–55 to 150	°C
Storage temperature range, T _{stg}	–65 to 150	°C
Latch-up performance meets 100 mA per AEC-Q100 Class I	100	mA
ESD ratings	Human-body model	2000
	Machine model	200
	Charged-device model	500

- (1) Stresses beyond those listed under *Absolute Maximum Ratings* may cause permanent damage to the device. These are stress ratings only, and functional operation of the device at these or any other conditions beyond those indicated under *Recommended Operating Conditions* is not implied. Exposure to absolute-maximum-rated conditions for extended periods may affect device reliability.
- (2) All voltage values are with respect to network ground terminal.

POWER DISSIPATION RATINGS

BOARD	PACKAGE	R _{θJC}	R _{θJA}	DERATING FACTOR ABOVE T _A = 25°C	T _A ≤ 25°C POWER RATING	T _A = 70°C POWER RATING	T _A = 85°C POWER RATING
Low-K ⁽¹⁾	DBV	64°C / W	255°C / W	3.9 mW / °C	390 mW	215 mW	155 mW
High-K ⁽²⁾	DBV	64°C / W	180°C / W	5.6 mW / °C	560 mW	310 mW	225 mW

- (1) The JEDEC low-K (1s) board design used to derive this data was a 3-inch × 3-inch (7,62-cm × 7,62-cm), two-layer board with 2-ounce (0.071-mm thick) copper traces on top of the board.
- (2) The JEDEC High-K (2s2p) board design used to derive this data was a 3 inch × 3 inch (7,62-cm × 7,62-cm), multilayer board with 1-ounce (0.035-mm thick) internal power and ground planes and 2-ounce (0.071-mm thick) copper traces on the top and bottom of the board.

ELECTRICAL CHARACTERISTICS

Over operating junction temperature range, $V_{IN} = V_{OUTnom} - 0.5V$, $I_{OUT} = 1mA$, $V_{EN} = 1.5V$, $C_{OUT} = 2.2\mu F$, and $C_{NR} = 0.01\mu F$, unless otherwise noted. Typical values are at $T_J = 25^\circ C$.

PARAMETER			TEST CONDITIONS	TPS723xx-Q1			UNITS
				MIN	TYP	MAX	
V_{IN}	Input voltage range ⁽¹⁾			-10		-2.7	V
V_{OUT}	Accuracy	Nominal	$T_J = 25^\circ C$	-1		1	%
		TPS723xx-Q1 versus $V_{IN} / I_{OUT} / T$	$-10V \leq V_{IN} \leq V_{OUT} - 0.5V$, $10 \mu A \leq I_{OUT} \leq 200 mA$	-2	± 1	2	%
$V_{OUT\%} / V_{IN}$	Line regulation		$-10 V \leq V_{IN} \leq V_{OUT(nom)} - 0.5 V$		0.04		% / V
$V_{OUT\%} / I_{OUT}$	Load regulation		$0 mA \leq I_{OUT} \leq 200 mA$		0.002		% / mA
V_{DO}	Dropout voltage at $V_{OUT} = 0.96 \times V_{OUTnom}$		$I_{OUT} = 200 mA$		280	500	mV
I_{CL}	Current limit		$V_{OUT} = 0.85 \times V_{OUT(nom)}$	300	550	800	mA
I_{GND}	Ground pin current		$I_{OUT} = 0 mA (I_Q)$, $-10 V \leq V_{IN} \leq V_{OUT} - 0.5 V$		130	200	μA
			$I_{OUT} = 200 mA$, $-10 V \leq V_{IN} \leq V_{OUT} - 0.5 V$		350	500	
I_{SHDN}	Shutdown ground pin current		$-0.4 V \leq V_{EN} \leq 0.4 V$, $-10V \leq V_{IN} \leq V_{OUT} - 0.5 V$		0.1	2	μA
PSRR	Power-supply rejection ratio		$I_{OUT} = 200 mA, 1 kHz$, $C_{IN} = C_{OUT} = 10 \mu F$		65		dB
			$I_{OUT} = 200 mA, 10 kHz$, $C_{IN} = C_{OUT} = 10 \mu F$		48		
V_n	Output noise voltage		$C_{OUT} = 10 \mu F, 10 Hz$ to $100 kHz$, $I_{OUT} = 200 mA$		60		μV_{RMS}
t_{STR}	Startup time		$V_{OUT} = -2.5 V, C_{OUT} = 1 \mu F$, $R_L = 25 \Omega$		1		ms
$V_{EN(HI)}$	Enable threshold positive			1.5			V
$V_{EN(LO)}$	Enable threshold negative					-1.5	V
$V_{DIS(HI)}$	Disable threshold positive					0.4	V
$V_{DIS(LO)}$	Disable threshold negative			-0.4			V
I_{EN}	Enable pin current		$-10 V \leq V_{IN} \leq V_{OUT} - 0.5 V$, $-10 V \leq V_{EN} \leq \pm 3.5 V$		0.1	2	μA
T_{SD}	Thermal shutdown temperature		Shutdown, temperature increasing		165		$^\circ C$
			Reset, temperature decreasing		145		
T_J	Operating junction temperature			-40		125	$^\circ C$

(1) Maximum $V_{IN} = (V_{OUT} - V_{DO})$ or $-2.7 V$, whichever is more negative.

FUNCTIONAL BLOCK DIAGRAM

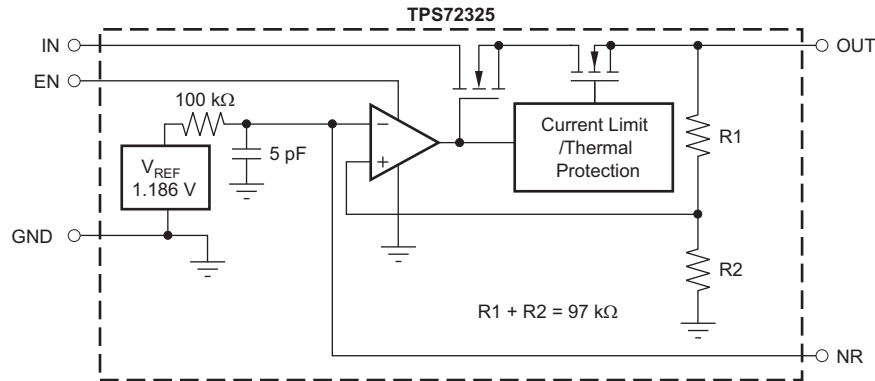

TERMINAL FUNCTIONS

TERMINAL		DESCRIPTION
NAME	NO.	
GND	1	Ground
IN	2	Input supply
EN	3	Bipolar enable pin. Driving this pin above the positive enable threshold or below the negative enable threshold turns on the regulator. Driving this pin below the positive disable threshold and above the negative disable threshold puts the regulator into shutdown mode.
NR	4	Fixed-voltage versions only. Connecting an external capacitor between this pin and ground bypasses noise generated by the internal band gap. This configuration allows output noise to be reduced to very low levels.
OUT	5	Regulated output voltage. The device requires the connection of a small 2.2-μF ceramic capacitor from this pin to GND to ensure stability.

TYPICAL CHARACTERISTICS

TPS723xx-Q1 at $V_{IN} = V_{OUTnom} - 0.5\text{ V}$, $I_{OUT} = 1\text{ mA}$, $V_{EN} = 1.5\text{ V}$, $C_{OUT} = 2.2\text{ }\mu\text{F}$, and $C_{NR} = 0.01\text{ }\mu\text{F}$, unless otherwise noted.

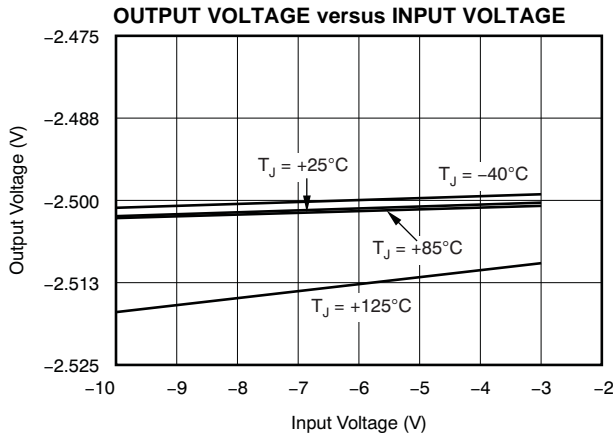

Figure 1.

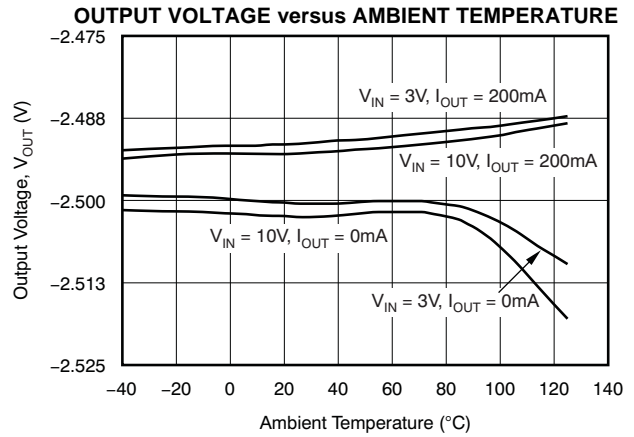

Figure 2.

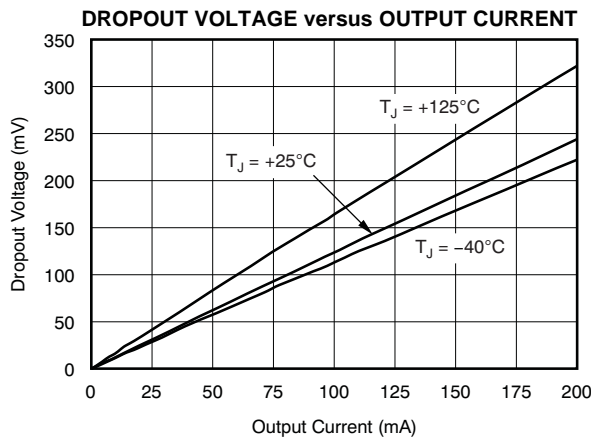

Figure 3.

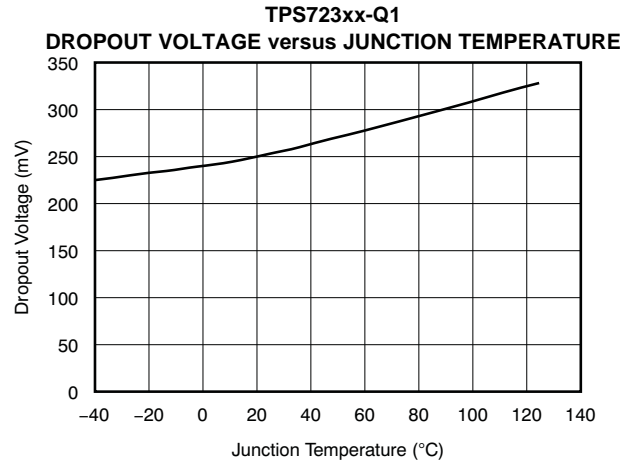

Figure 4.

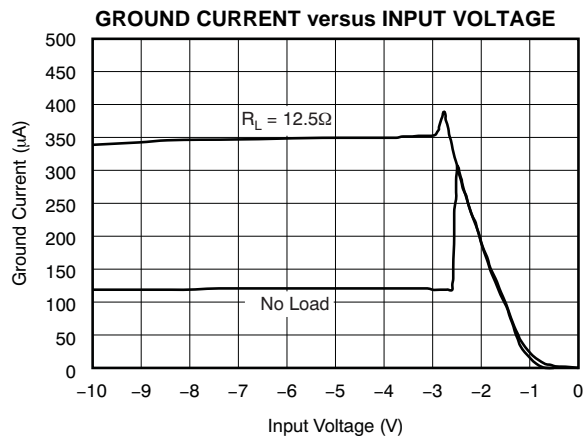

Figure 5.

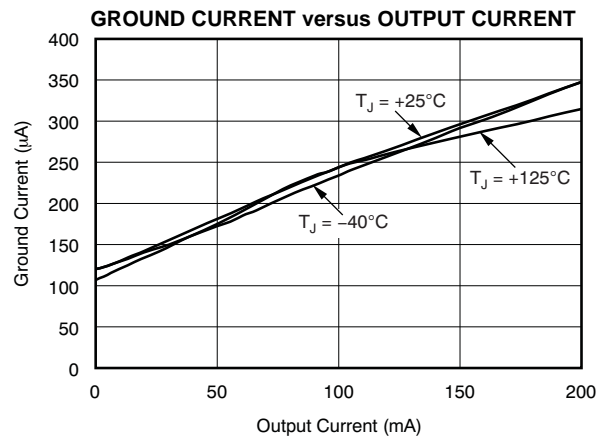

Figure 6.

TYPICAL CHARACTERISTICS (continued)

TPS723xx-Q1 at $V_{IN} = V_{OUTnom} - 0.5\text{ V}$, $I_{OUT} = 1\text{ mA}$, $V_{EN} = 1.5\text{ V}$, $C_{OUT} = 2.2\text{ }\mu\text{F}$, and $C_{NR} = 0.01\text{ }\mu\text{F}$, unless otherwise noted.

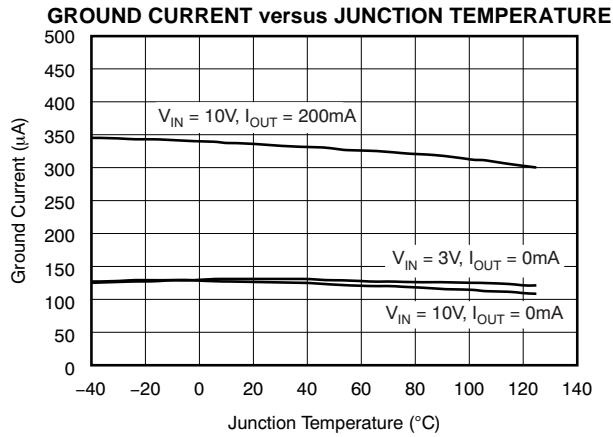

Figure 7.

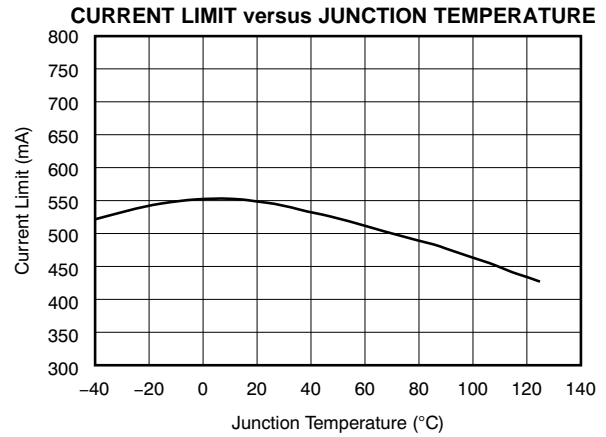

Figure 8.

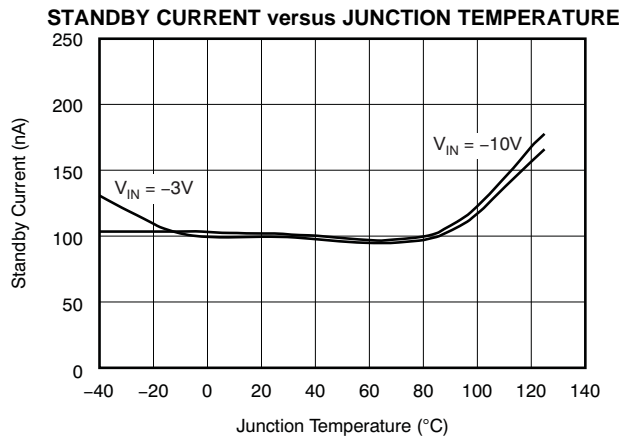

Figure 9.

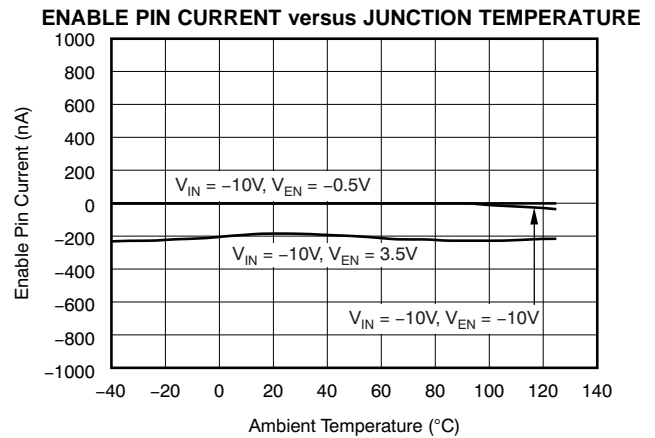

Figure 10.

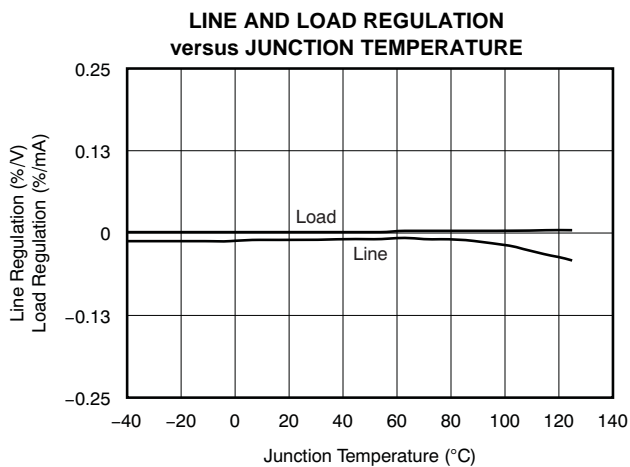

Figure 11.

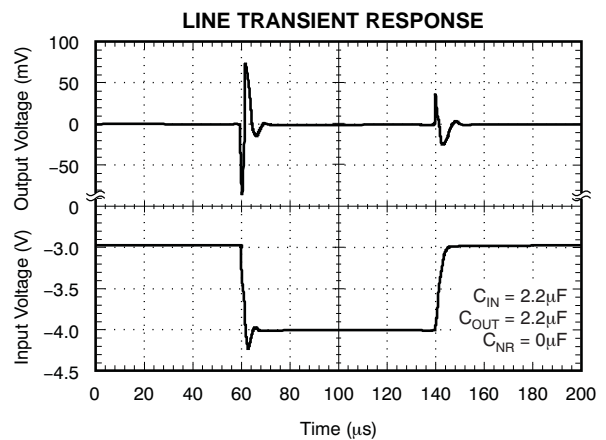

Figure 12.

TYPICAL CHARACTERISTICS (continued)

TPS723xx-Q1 at $V_{IN} = V_{OUTnom} - 0.5\text{ V}$, $I_{OUT} = 1\text{ mA}$, $V_{EN} = 1.5\text{ V}$, $C_{OUT} = 2.2\text{ }\mu\text{F}$, and $C_{NR} = 0.01\text{ }\mu\text{F}$, unless otherwise noted.

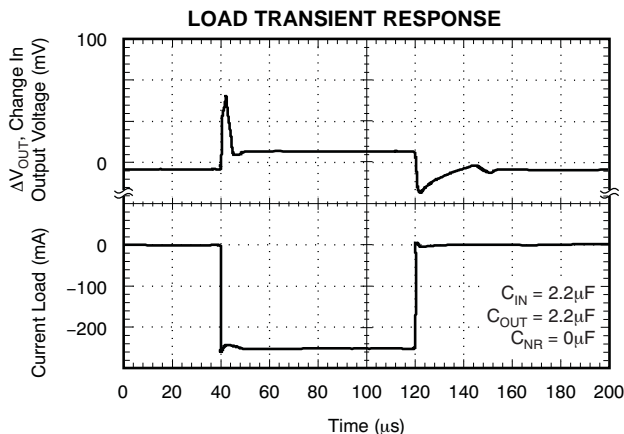

Figure 13.

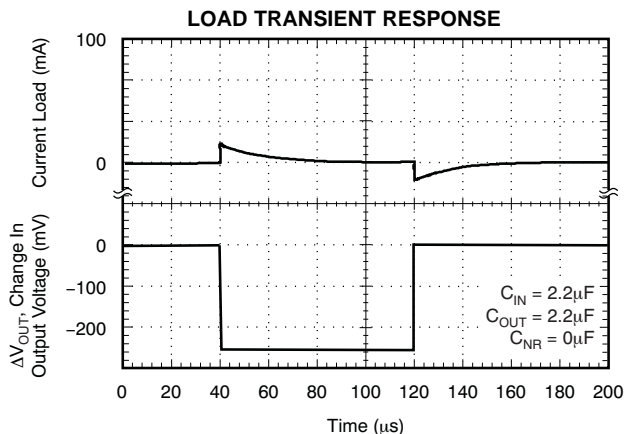

Figure 14.

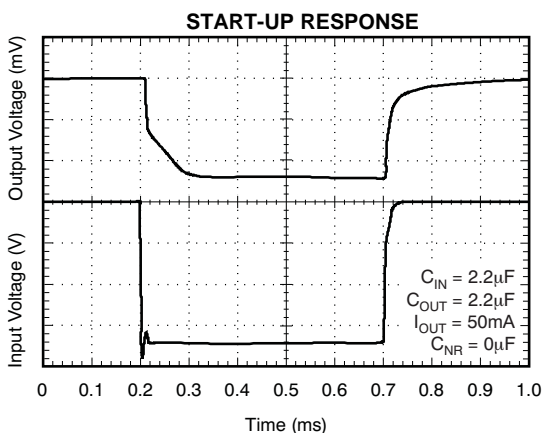

Figure 15.

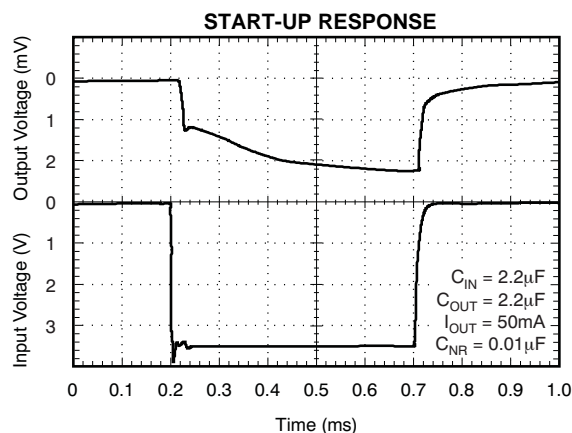

Figure 16.

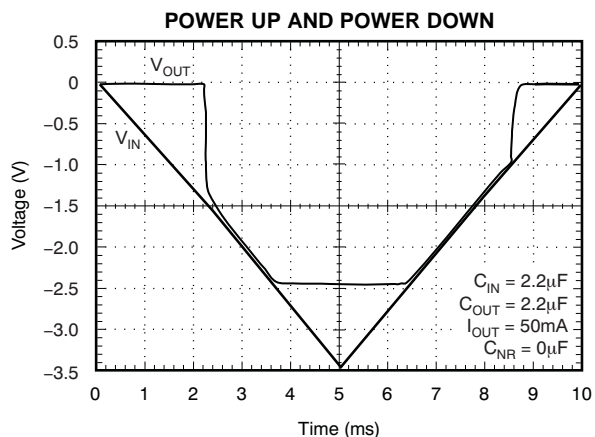

Figure 17.

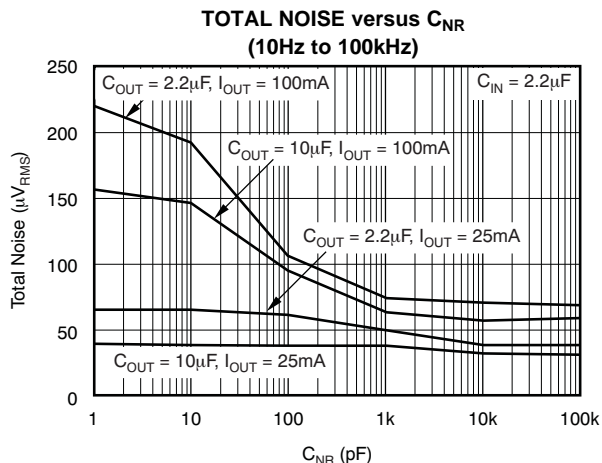

Figure 18.

TYPICAL CHARACTERISTICS (continued)

TPS723xx-Q1 at $V_{IN} = V_{OUTnom} - 0.5\text{ V}$, $I_{OUT} = 1\text{ mA}$, $V_{EN} = 1.5\text{ V}$, $C_{OUT} = 2.2\text{ }\mu\text{F}$, and $C_{NR} = 0.01\text{ }\mu\text{F}$, unless otherwise noted.

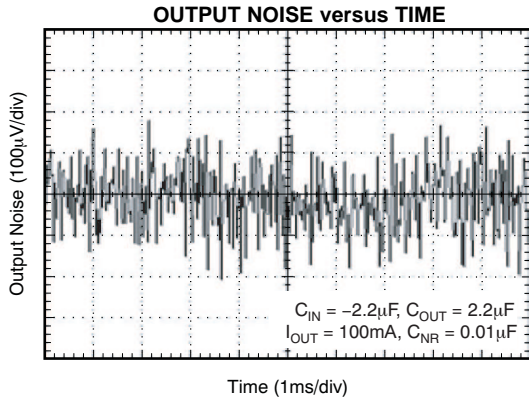

Figure 19.

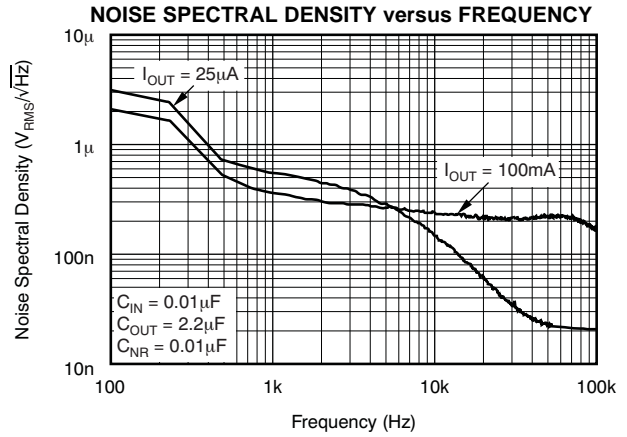

Figure 20.

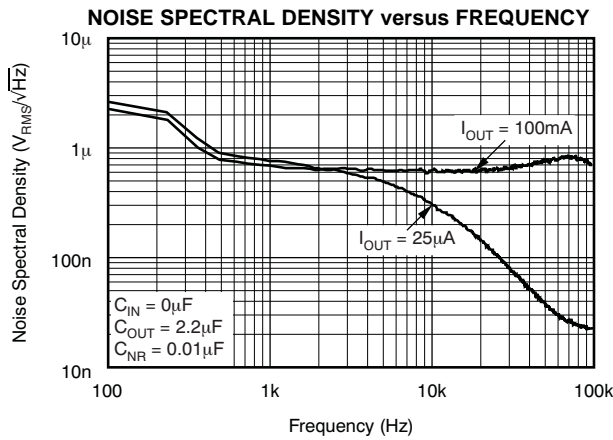

Figure 21.

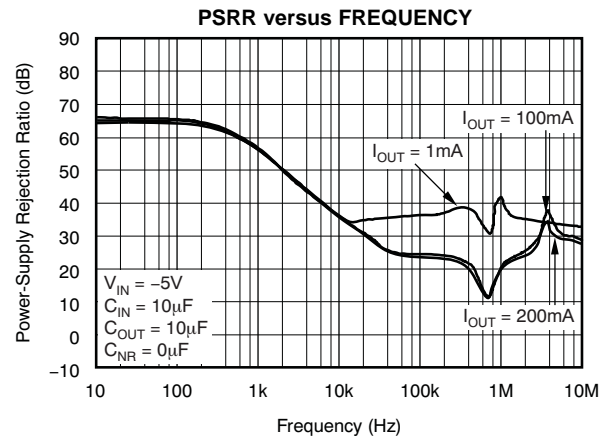

Figure 22.

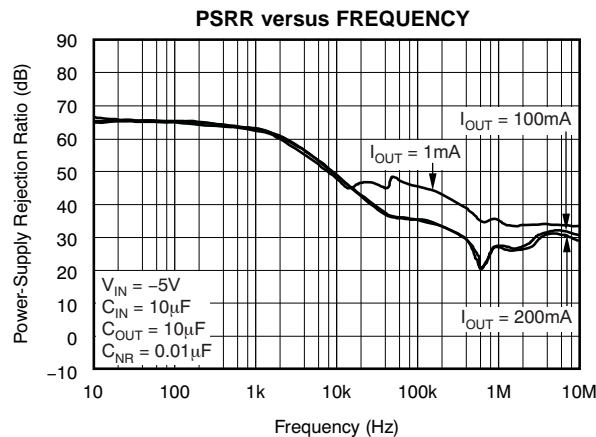

Figure 23.

APPLICATION INFORMATION

DEVICE OPERATION

The TPS723xx-Q1 is a low-dropout negative linear voltage regulator with a rated current of 200 mA. It features very low noise and high power-supply rejection ratio (PSRR), making it ideal for high-sensitivity analog and RF applications. A shutdown mode is available, reducing ground current to 2 μ A maximum over temperature and process. The TPS723xx-Q1 comes in a small SOT23 package, specified over a -40°C to 125°C junction-temperature range.

ENABLE

The enable pin is active above 1.5 V and below -1.5 V, allowing control by a standard TTL signal or by connection to V_I if not used. Driving the pin to GND turns off most internal circuitry, putting the TPS723xx-Q1 into shutdown mode, drawing 2- μ A maximum ground current.

CAPACITOR SELECTION FOR STABILITY

Use appropriate input and output capacitors for the intended application. The TPS723xx-Q1 only requires the use of a 2.2- μ F ceramic output capacitor for stable operation. Both the capacitor value and ESR affect stability, output noise, PSRR, and transient response. For typical applications, a 2.2- μ F ceramic output capacitor located close to the regulator is sufficient.

OUTPUT NOISE

Without external bypassing, output noise of the TPS723xx-Q1 from 10 Hz to 100 kHz is 200 μV_{RMS} typical. The dominant contributor to output noise is the internal band-gap reference. Adding an external 0.01- μ F capacitor to ground reduces the noise to 60 μV_{RMS} . To achieve best noise performance, use appropriate low-ESR capacitors for bypassing noise at the NR and OUT pins. See Figure 18 in the Typical Characteristics section.

POWER-SUPPLY REJECTION

The TPS723xx-Q1 offers a very high PSRR for applications with noisy input sources or highly sensitive output supply lines. For best PSRR, use high-quality input and output capacitors.

CURRENT LIMIT

The TPS723xx-Q1 has internal circuitry that monitors and limits output current to protect the regulator from damage under all load conditions. When output current reaches the output-current limit (550 mA typical), protection circuitry turns on, reducing output voltage to ensure that current does not increase. See Figure 8 in the Typical Characteristics section.

Do not drive the output more than 0.3 V above the input. Doing so biases the body diode in the pass FET, allowing current to flow from the output to the input. The device does not limit this current. If this condition is likely, take care to limit the reverse current externally.

THERMAL PROTECTION

As protection from damage due to excessive junction temperatures, the TPS723xx-Q1 has internal protection circuitry. When junction temperature reaches approximately 165°C , the output device turns off. After the device has cooled by about 20°C , the output device turns on, allowing normal operation. For reliable operation, design is for worst-case junction temperature of $\leq 125^{\circ}\text{C}$, taking into account worst-case ambient temperature and load conditions.

ADJUSTABLE VOLTAGE APPLICATIONS

The TPS72301-Q1 allows designers to specify any output voltage from -10 V to -1.2 V. As shown in the application circuit in Figure 24, use of an external resistor divider scales the output voltage (V_{OUT}) to the reference voltage. For best accuracy, use precision resistors for R1 and R2. Use the equations in Figure 24 to determine the values for the resistor divider.

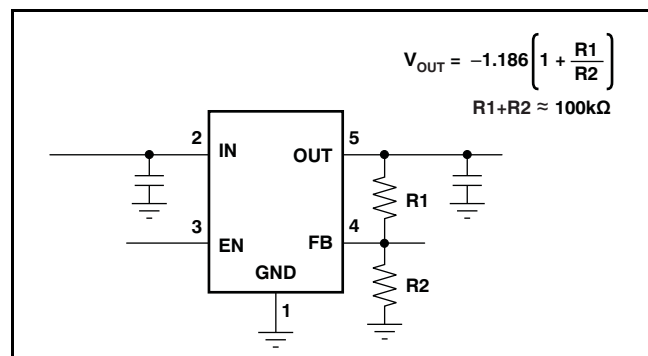

Figure 24. TPS72301-Q1 Adjustable LDO Regulator Programming

PACKAGING INFORMATION

Orderable Device	Status ⁽¹⁾	Package Type	Package Drawing	Pins	Package Qty	Eco Plan ⁽²⁾	Lead/ Ball Finish	MSL Peak Temp ⁽³⁾	Samples (Requires Login)
TPS72301QDBVRQ1	ACTIVE	SOT-23	DBV	5	3000	Green (RoHS & no Sb/Br)	CU NIPDAU	Level-1-260C-UNLIM	
TPS72325QDBVRQ1	ACTIVE	SOT-23	DBV	5	3000	Green (RoHS & no Sb/Br)	CU NIPDAU	Level-1-260C-UNLIM	

⁽¹⁾ The marketing status values are defined as follows:

ACTIVE: Product device recommended for new designs.

LIFEBUY: TI has announced that the device will be discontinued, and a lifetime-buy period is in effect.

NRND: Not recommended for new designs. Device is in production to support existing customers, but TI does not recommend using this part in a new design.

PREVIEW: Device has been announced but is not in production. Samples may or may not be available.

OBsolete: TI has discontinued the production of the device.

⁽²⁾ Eco Plan - The planned eco-friendly classification: Pb-Free (RoHS), Pb-Free (RoHS Exempt), or Green (RoHS & no Sb/Br) - please check <http://www.ti.com/productcontent> for the latest availability information and additional product content details.

TBD: The Pb-Free/Green conversion plan has not been defined.

Pb-Free (RoHS): TI's terms "Lead-Free" or "Pb-Free" mean semiconductor products that are compatible with the current RoHS requirements for all 6 substances, including the requirement that lead not exceed 0.1% by weight in homogeneous materials. Where designed to be soldered at high temperatures, TI Pb-Free products are suitable for use in specified lead-free processes.

Pb-Free (RoHS Exempt): This component has a RoHS exemption for either 1) lead-based flip-chip solder bumps used between the die and package, or 2) lead-based die adhesive used between the die and leadframe. The component is otherwise considered Pb-Free (RoHS compatible) as defined above.

Green (RoHS & no Sb/Br): TI defines "Green" to mean Pb-Free (RoHS compatible), and free of Bromine (Br) and Antimony (Sb) based flame retardants (Br or Sb do not exceed 0.1% by weight in homogeneous material)

⁽³⁾ MSL, Peak Temp. -- The Moisture Sensitivity Level rating according to the JEDEC industry standard classifications, and peak solder temperature.

Important Information and Disclaimer: The information provided on this page represents TI's knowledge and belief as of the date that it is provided. TI bases its knowledge and belief on information provided by third parties, and makes no representation or warranty as to the accuracy of such information. Efforts are underway to better integrate information from third parties. TI has taken and continues to take reasonable steps to provide representative and accurate information but may not have conducted destructive testing or chemical analysis on incoming materials and chemicals. TI and TI suppliers consider certain information to be proprietary, and thus CAS numbers and other limited information may not be available for release.

In no event shall TI's liability arising out of such information exceed the total purchase price of the TI part(s) at issue in this document sold by TI to Customer on an annual basis.

OTHER QUALIFIED VERSIONS OF TPS72301-Q1, TPS72325-Q1 :

- Catalog: [TPS72301](#), [TPS72325](#)

NOTE: Qualified Version Definitions:

- Catalog - TI's standard catalog product

TAPE AND REEL INFORMATION
REEL DIMENSIONS

TAPE DIMENSIONS

A0	Dimension designed to accommodate the component width
B0	Dimension designed to accommodate the component length
K0	Dimension designed to accommodate the component thickness
W	Overall width of the carrier tape
P1	Pitch between successive cavity centers

TAPE AND REEL INFORMATION

*All dimensions are nominal

Device	Package Type	Package Drawing	Pins	SPQ	Reel Diameter (mm)	Reel Width W1 (mm)	A0 (mm)	B0 (mm)	K0 (mm)	P1 (mm)	W (mm)	Pin1 Quadrant
TPS72301QDBVRQ1	SOT-23	DBV	5	3000	179.0	8.4	3.2	3.2	1.4	4.0	8.0	Q3
TPS72325QDBVRQ1	SOT-23	DBV	5	3000	179.0	8.4	3.2	3.2	1.4	4.0	8.0	Q3

TAPE AND REEL BOX DIMENSIONS

*All dimensions are nominal

Device	Package Type	Package Drawing	Pins	SPQ	Length (mm)	Width (mm)	Height (mm)
TPS72301QDBVRQ1	SOT-23	DBV	5	3000	203.0	203.0	35.0
TPS72325QDBVRQ1	SOT-23	DBV	5	3000	203.0	203.0	35.0

DBV (R-PDSO-G5)

PLASTIC SMALL-OUTLINE PACKAGE



- NOTES:
- A. All linear dimensions are in millimeters.
 - B. This drawing is subject to change without notice.
 - C. Body dimensions do not include mold flash or protrusion. Mold flash and protrusion shall not exceed 0.15 per side.
 - D. Falls within JEDEC MO-178 Variation AA.

DBV (R-PDSO-G5)

PLASTIC SMALL OUTLINE



- NOTES:
- A. All linear dimensions are in millimeters.
 - B. This drawing is subject to change without notice.
 - C. Customers should place a note on the circuit board fabrication drawing not to alter the center solder mask defined pad.
 - D. Publication IPC-7351 is recommended for alternate designs.
 - E. Laser cutting apertures with trapezoidal walls and also rounding corners will offer better paste release. Customers should contact their board assembly site for stencil design recommendations. Example stencil design based on a 50% volumetric metal load solder paste. Refer to IPC-7525 for other stencil recommendations.

IMPORTANT NOTICE

Texas Instruments Incorporated and its subsidiaries (TI) reserve the right to make corrections, enhancements, improvements and other changes to its semiconductor products and services per JESD46, latest issue, and to discontinue any product or service per JESD48, latest issue. Buyers should obtain the latest relevant information before placing orders and should verify that such information is current and complete. All semiconductor products (also referred to herein as "components") are sold subject to TI's terms and conditions of sale supplied at the time of order acknowledgment.

TI warrants performance of its components to the specifications applicable at the time of sale, in accordance with the warranty in TI's terms and conditions of sale of semiconductor products. Testing and other quality control techniques are used to the extent TI deems necessary to support this warranty. Except where mandated by applicable law, testing of all parameters of each component is not necessarily performed.

TI assumes no liability for applications assistance or the design of Buyers' products. Buyers are responsible for their products and applications using TI components. To minimize the risks associated with Buyers' products and applications, Buyers should provide adequate design and operating safeguards.

TI does not warrant or represent that any license, either express or implied, is granted under any patent right, copyright, mask work right, or other intellectual property right relating to any combination, machine, or process in which TI components or services are used. Information published by TI regarding third-party products or services does not constitute a license to use such products or services or a warranty or endorsement thereof. Use of such information may require a license from a third party under the patents or other intellectual property of the third party, or a license from TI under the patents or other intellectual property of TI.

Reproduction of significant portions of TI information in TI data books or data sheets is permissible only if reproduction is without alteration and is accompanied by all associated warranties, conditions, limitations, and notices. TI is not responsible or liable for such altered documentation. Information of third parties may be subject to additional restrictions.

Resale of TI components or services with statements different from or beyond the parameters stated by TI for that component or service voids all express and any implied warranties for the associated TI component or service and is an unfair and deceptive business practice. TI is not responsible or liable for any such statements.

Buyer acknowledges and agrees that it is solely responsible for compliance with all legal, regulatory and safety-related requirements concerning its products, and any use of TI components in its applications, notwithstanding any applications-related information or support that may be provided by TI. Buyer represents and agrees that it has all the necessary expertise to create and implement safeguards which anticipate dangerous consequences of failures, monitor failures and their consequences, lessen the likelihood of failures that might cause harm and take appropriate remedial actions. Buyer will fully indemnify TI and its representatives against any damages arising out of the use of any TI components in safety-critical applications.

In some cases, TI components may be promoted specifically to facilitate safety-related applications. With such components, TI's goal is to help enable customers to design and create their own end-product solutions that meet applicable functional safety standards and requirements. Nonetheless, such components are subject to these terms.

No TI components are authorized for use in FDA Class III (or similar life-critical medical equipment) unless authorized officers of the parties have executed a special agreement specifically governing such use.

Only those TI components which TI has specifically designated as military grade or "enhanced plastic" are designed and intended for use in military/aerospace applications or environments. Buyer acknowledges and agrees that any military or aerospace use of TI components which have **not** been so designated is solely at the Buyer's risk, and that Buyer is solely responsible for compliance with all legal and regulatory requirements in connection with such use.

TI has specifically designated certain components which meet ISO/TS16949 requirements, mainly for automotive use. Components which have not been so designated are neither designed nor intended for automotive use; and TI will not be responsible for any failure of such components to meet such requirements.

Products

Audio	www.ti.com/audio
Amplifiers	amplifier.ti.com
Data Converters	dataconverter.ti.com
DLP® Products	www.dlp.com
DSP	dsp.ti.com
Clocks and Timers	www.ti.com/clocks
Interface	interface.ti.com
Logic	logic.ti.com
Power Mgmt	power.ti.com
Microcontrollers	microcontroller.ti.com
RFID	www.ti-rfid.com
OMAP Applications Processors	www.ti.com/omap
Wireless Connectivity	www.ti.com/wirelessconnectivity

Applications

Automotive and Transportation	www.ti.com/automotive
Communications and Telecom	www.ti.com/communications
Computers and Peripherals	www.ti.com/computers
Consumer Electronics	www.ti.com/consumer-apps
Energy and Lighting	www.ti.com/energy
Industrial	www.ti.com/industrial
Medical	www.ti.com/medical
Security	www.ti.com/security
Space, Avionics and Defense	www.ti.com/space-avionics-defense
Video and Imaging	www.ti.com/video

TI E2E Community

e2e.ti.com