

LOW-NOISE FAST-TRANSIENT-RESPONSE 1.5-A LOW-DROPOUT VOLTAGE REGULATOR

Check for Samples: [TPS7A4501M](#)

FEATURES

- Optimized for Fast Transient Response
- Output Current: 1.5 A
- High Output Voltage Accuracy: 1% at 25°C
- Dropout Voltage: 300 mV
- Low Noise: 35 μV_{RMS} (10 Hz to 100 kHz)
- High Ripple Rejection: 68 dB at 1KHz
- 1-mA Quiescent Current
- No Protection Diodes Needed
- Controlled Quiescent Current in Dropout
- Adjustable Output from 1.21 V to 20 V
- Less Than 1- μA Quiescent Current in Shutdown
- Stable with 10- μF Ceramic Output Capacitor
- Reverse-Battery Protection
- Reverse Current Protection

APPLICATIONS

- Industrial
- Wireless Infrastructure
- Radio-Frequency Systems

SUPPORTS DEFENSE, AEROSPACE, AND MEDICAL APPLICATIONS

- Controlled Baseline
- One Assembly and Test Site
- One Fabrication Site
- Available in Military (–55°C to 125°C) Temperature Range ⁽¹⁾
- Extended Product Life Cycle
- Extended Product-Change Notification
- Product Traceability

(1) Custom temperature ranges available

**U PACKAGE
(TOP VIEW)**

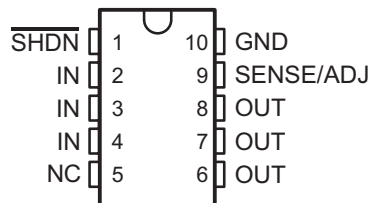

DESCRIPTION

The TPS7A4501 is a low-dropout (LDO) regulator optimized for fast transient response. The device can supply 1.5 A of output current with a dropout voltage of 300 mV. Operating quiescent current is 1 mA, dropping to less than 1 μA in shutdown. Quiescent current is well controlled; it does not rise in dropout, as with many other regulators. In addition to fast transient response, the TPS7A4501 regulator has very low output noise, which makes it ideal for sensitive RF supply applications.

Output voltage range is from 1.21 V to 20 V. The TPS7A4501 is stable with output capacitance as low as 10 μF . Small ceramic capacitors can be used without the necessary addition of ESR, as is common with other regulators. Internal protection circuitry includes reverse-battery protection, current limiting, thermal limiting, and reverse-current protection. The device is available as an adjustable device with a 1.21-V reference voltage. The TPS7A4501 regulator is available in the 10-pin GDFP (U) package.



Please be aware that an important notice concerning availability, standard warranty, and use in critical applications of Texas Instruments semiconductor products and disclaimers thereto appears at the end of this data sheet.



This integrated circuit can be damaged by ESD. Texas Instruments recommends that all integrated circuits be handled with appropriate precautions. Failure to observe proper handling and installation procedures can cause damage.

ESD damage can range from subtle performance degradation to complete device failure. Precision integrated circuits may be more susceptible to damage because very small parametric changes could cause the device not to meet its published specifications.

ORDERING INFORMATION⁽¹⁾

T _J	PACKAGE	ORDERABLE PART NUMBER	TOP-SIDE MARKING
-55°C to 125°C	GDFP (U)	TPS7A4501MUB 5962-1222401QHA	1222401QHA 7A4501MU
	KGD	TPS7A4501MKGD1 5962-1222401Q9A	N/A

(1) For the most current package and ordering information, see the Package Option Addendum at the end of this document, or see the TI website at www.ti.com.

BARE DIE INFORMATION

DIE THICKNESS	BACKSIDE FINISH	BACKSIDE POTENTIAL	BOND PAD METALLIZATION COMPOSITION	BOND PAD THICKNESS
15 mils.	Silicon with backgrind	Floating	TiW/AICu2	1627 nm

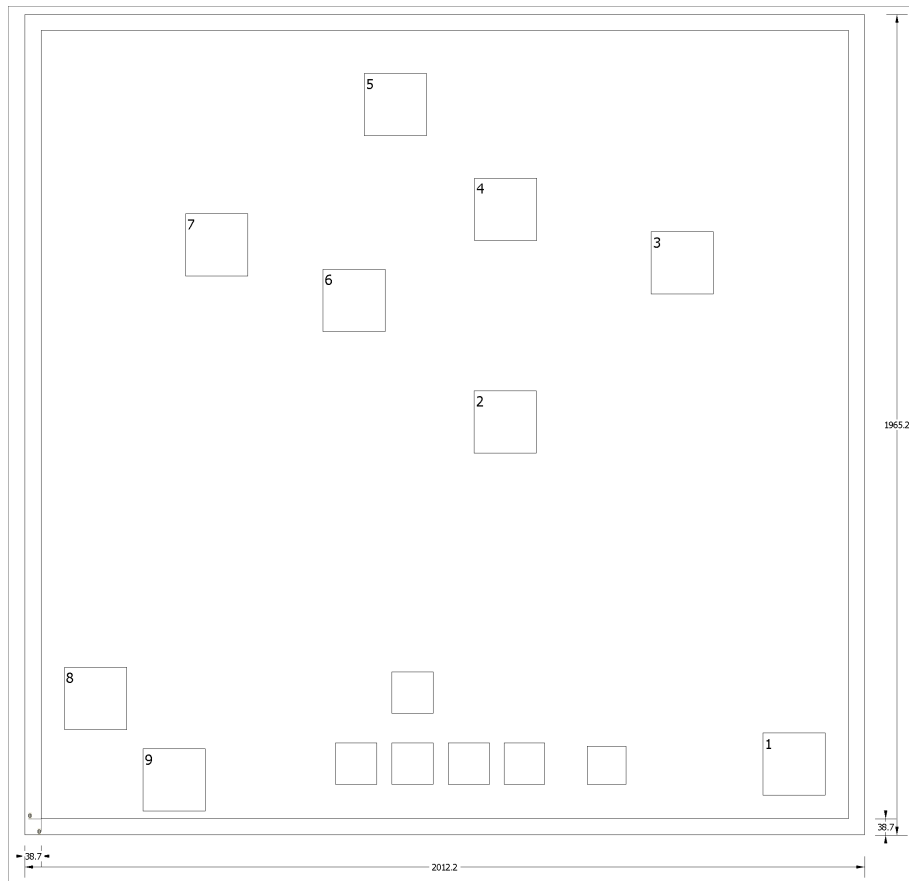

Table 1. Bond Pad Coordinates in Microns⁽¹⁾

DESCRIPTION	PAD NUMBER	X MIN	Y MIN	X MAX	Y MAX
SHDN	1	1729.25	55.5	1879.25	205.5
IN	2	1037.25	875	1187.25	1025
IN	3	1460.75	1255.5	1610.75	1405.5
IN	4	1037.75	1384.5	1187.75	1534.5
OUT	5	774.25	1634.75	924.25	1784.75
OUT	6	675.25	1166	825.25	1316
OUT	7	345.5	1299.25	495.5	1449.25
SENSE/ADJ	8	55.5	213	205.5	363
GND	9	244	17.5	394	167.5

(1) Substrate is not to be connected.

ABSOLUTE MAXIMUM RATINGS⁽¹⁾

over operating junction temperature range (unless otherwise noted)

Input voltage range, V_{IN}	IN	-20 V to 20 V
	OUT	-20 V to 20 V
	Input-to-output differential ⁽²⁾	-20 V to 20 V
	ADJ	-7 V to 7 V
	SHDN	-20 V to 20 V
Maximum lead temperature (10-s soldering time), T_{lead}		260°C
Maximum operating junction temperature, T_J		125°C
Storage temperature range, T_{stg}		-65°C to 150°C

- (1) Stresses beyond those listed under *Absolute Maximum Ratings* may cause permanent damage to the device. These are stress ratings only, and functional operation of the device at these or any other conditions beyond those indicated under *Recommended Operating Conditions* is not implied. Exposure to absolute-maximum-rated conditions for extended periods may affect device reliability.
- (2) Absolute maximum input-to-output differential voltage cannot be achieved with all combinations of rated IN pin and OUT pin voltages. With the IN pin at 20 V, the OUT pin may not be pulled below 0 V. The total measured voltage from IN to OUT can not exceed ± 20 V.

RECOMMENDED OPERATING CONDITIONS

over operating junction temperature range (unless otherwise noted)

		MIN	NOM	MAX	UNIT
T_J	Operating junction temperature	-55		125	°C

THERMAL INFORMATION

THERMAL METRIC	TPS7A4501	
	U	UNITS
	10 PINS	
θ_{JC} Package thermal impedance ⁽¹⁾	14.7	°C/W

- (1) The package thermal impedance is calculated in accordance with JESD 51-7 (plastic) or MIL-STD-883 Method 1012 (ceramic).

ELECTRICAL CHARACTERISTICS

Over operating junction temperature range $T_J = -55^{\circ}\text{C}$ to 125°C (unless otherwise noted)

PARAMETER		TEST CONDITIONS	T_J	MIN	TYP ⁽¹⁾	MAX	UNIT
V_{IN}	Minimum input voltage ^{(2) (3)}	$I_{LOAD} = 0.5\text{ A}$	25°C		1.9	2.3	V
		$I_{LOAD} = 1.5\text{ A}$	Full range		2.1	2.5	
V_{ADJ}	ADJ pin voltage ^{(2) (4)}	$V_{IN} = 2.21\text{ V}, I_{LOAD} = 1\text{ mA}$	25°C	1.197	1.21	1.222	V
		$V_{IN} = 2.5\text{ V to }20\text{ V}, I_{LOAD} = 1\text{ mA to }1.5\text{ A}$	Full range	1.174	1.21	1.246	
	Line regulation ⁽²⁾	$\Delta V_{IN} = 2.21\text{ V to }20\text{ V}, I_{LOAD} = 1\text{ mA}$	Full range		1.5	3	mV
	Load regulation ⁽²⁾	$V_{IN} = 2.5\text{ V}, \Delta I_{LOAD} = 1\text{ mA to }1.5\text{ A}$	25°C		2	8	mV
			Full range				
V_{DO}	Dropout voltage ^{(5) (6)} $V_{IN} = 2.4\text{ V}$	$I_{LOAD} = 1\text{ mA}$	25°C		0.02	0.05	V
			Full range				
		$I_{LOAD} = 100\text{ mA}$	25°C		0.085	0.10	
			Full range				
		$I_{LOAD} = 500\text{ mA}$	25°C		0.17	0.21	
			Full range				
$I_{LOAD} = 1.5\text{ A}$	25°C		0.300	0.50			
	Full range				0.750		
I_{GND}	GND pin current ^{(6) (7)} $V_{IN} = 2.5\text{ V}$	$I_{LOAD} = 0\text{ mA}$	Full range		1	1.5	mA
		$I_{LOAD} = 1\text{ mA}$	Full range		1.1	1.6	
		$I_{LOAD} = 100\text{ mA}$	Full range		3.3	7	
		$I_{LOAD} = 500\text{ mA}$	Full range		15	30	
		$I_{LOAD} = 1.5\text{ A}$	Full range		80	130	
e_N ⁽⁸⁾	Output voltage noise	$C_{OUT} = 10\text{ }\mu\text{F}, I_{LOAD} = 1.5\text{ A}, B_W = 10\text{ Hz to }100\text{ kHz}$	25°C		35	55	μV_{RMS}
I_{ADJ}	ADJ pin bias current ^{(2) (9)}		25°C		3	7	μA
	Shutdown threshold	$V_{OUT} = \text{OFF to ON}$	Full range		0.9	2	V
		$V_{OUT} = \text{ON to OFF}$	Full range	0.15	0.75		
I_{SHDN}	$\overline{\text{SHDN}}$ pin current	$V_{SHDN} = 0\text{ V}$	25°C		0.01	1	μA
		$V_{SHDN} = 20\text{ V}$	25°C		3	20	
	Quiescent current in shutdown	$V_{IN} = 6\text{ V}, V_{SHDN} = 0\text{ V}$	25°C		0.01	1	μA
	Ripple rejection ⁽¹⁰⁾	$V_{IN} - V_{OUT} = 1.5\text{ V (avg)}, V_{RIPPLE} = 0.5\text{ V}_{P-P}, f_{RIPPLE} = 120\text{ Hz}, I_{LOAD} = 0.75\text{ A}$	25°C		60	68	dB
I_{LIMIT}	Current limit ⁽¹⁰⁾	$V_{IN} = 7\text{ V}, V_{OUT} = 0\text{ V}$	25°C		1.7	1.9	A
		$V_{IN} = 2.5\text{ V}$	Full range		1.6	1.9	
I_{IL}	Input reverse leakage current	$V_{IN} = -20\text{ V}, V_{OUT} = 0\text{ V}$	Full range			300	μA
I_{RO}	Reverse output current ⁽¹¹⁾	$V_{OUT} = 1.21\text{ V}, V_{IN} < 1.21\text{ V}$	25°C		300	500	μA

- (1) Typical values represent the likely parametric nominal values determined at the time of characterization. Typical values depend on the application and configuration and may vary over time. Typical values are not ensured on production material.
- (2) The TPS7A4501 is tested and specified for these conditions with the ADJ pin connected to the OUT pin.
- (3) Dropout voltages are limited by the minimum input voltage specification under some output voltage/load conditions.
- (4) Operating conditions are limited by maximum junction temperature. The regulated output voltage specification does not apply for all possible combinations of input voltage and output current. When operating at maximum input voltage, the output current range must be limited. When operating at maximum output current, the input voltage range must be limited.
- (5) Dropout voltage is the minimum input to output voltage differential needed to maintain regulation at a specified output current. In dropout, the output voltage is equal to: $V_{IN} - V_{DROPOUT}$.
- (6) To satisfy requirements for minimum input voltage, the TPS7A4501 is tested and specified for these conditions with an external resistor divider (two 4.12-k Ω resistors) for an output voltage of 2.4 V. The external resistor divider adds a 300- μA DC load on the output.
- (7) GND pin current is tested with $V_{IN} = 2.5\text{ V}$ and a current source load. The GND pin current decreases at higher input voltages.
- (8) Specification is guaranteed by bench characterization and is not tested in production.
- (9) ADJ pin bias current flows into the ADJ pin.
- (10) Specification is guaranteed by characterization for KGD and is not tested in production.
- (11) Reverse output current is tested with the IN pin grounded and the OUT pin forced to the rated output voltage. This current flows into the OUT pin and out the GND pin.

DEVICE INFORMATION
TERMINAL FUNCTIONS

PIN		DESCRIPTION
NO.	NAME	
1	$\overline{\text{SHDN}}$	Shutdown. $\overline{\text{SHDN}}$ is used to put the TPS7A4501 regulator into a low-power shutdown state. The output is off when $\overline{\text{SHDN}}$ is pulled low. $\overline{\text{SHDN}}$ can be driven by 5-V logic, 3-V logic or open-collector logic with a pullup resistor. The pullup resistor is required to supply the pullup current of the open-collector gate, normally several microamperes, and $\overline{\text{SHDN}}$ current, typically 3 μA . If unused, $\overline{\text{SHDN}}$ must be connected to V_{IN} . The device is in the low-power shutdown state if $\overline{\text{SHDN}}$ is not connected.
2, 3, 4	IN	Input. Power is supplied to the device through IN. A bypass capacitor is required on this pin if the device is more than six inches away from the main input filter capacitor. In general, the output impedance of a battery rises with frequency, so it is advisable to include a bypass capacitor in battery-powered circuits. A bypass capacitor (ceramic) in the range of 1 μF to 10 μF is sufficient. The TPS7A4501 regulator is designed to withstand reverse voltages on IN with respect to ground and on OUT. In the case of a reverse input, which can happen if a battery is plugged in backwards, the device acts as if there is a diode in series with its input. There is no reverse current flow into the regulator, and no reverse voltage appears at the load. The device protects both itself and the load.
5	NC	Not connected
6, 7, 8	OUT	Output. The output supplies power to the load. A minimum output capacitor (ceramic) of 10 μF is required to prevent oscillations. Larger output capacitors are required for applications with large transient loads to limit peak voltage transients.
9	ADJ	Adjust. This is the input to the error amplifier. ADJ is internally clamped to ± 7 V. It has a bias current of 3 μA that flows into the pin. ADJ voltage is 1.21 V referenced to ground, and the output voltage range is 1.21 V to 20 V.
10	GND	Ground.

TYPICAL CHARACTERISTICS

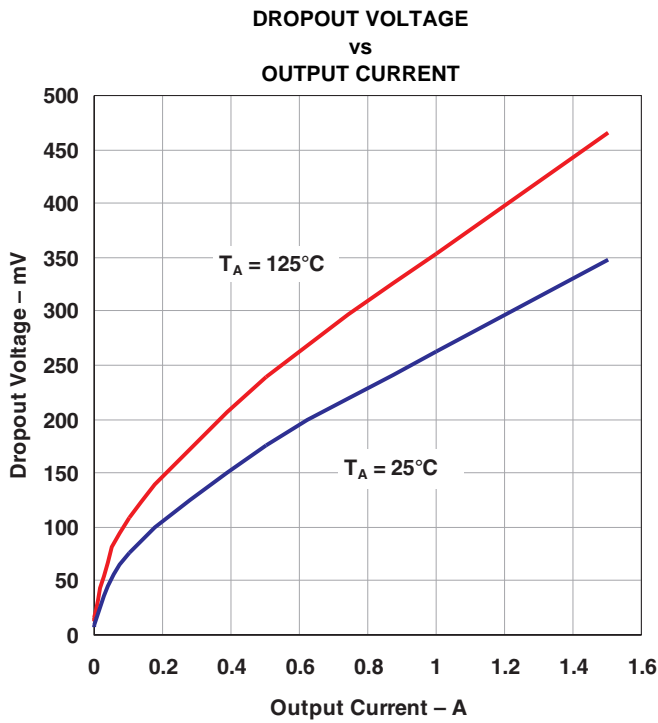

Figure 1.

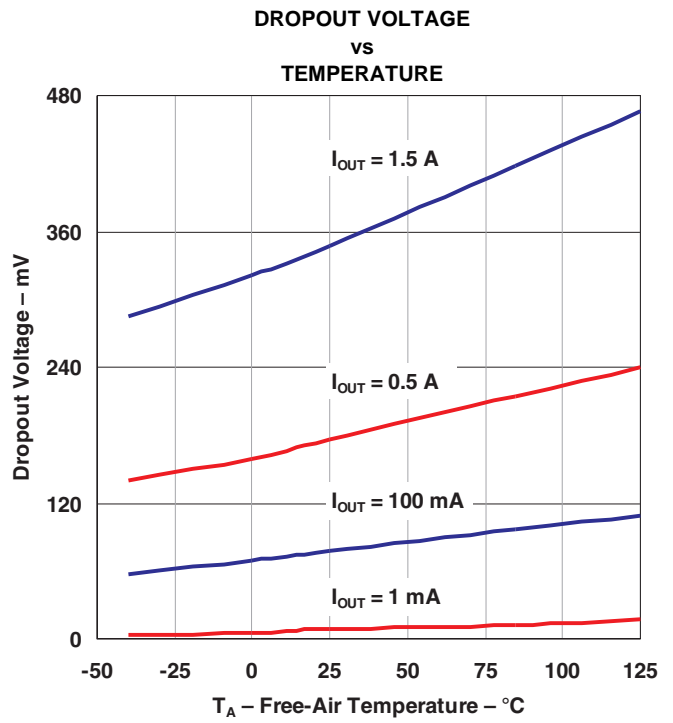

Figure 2.

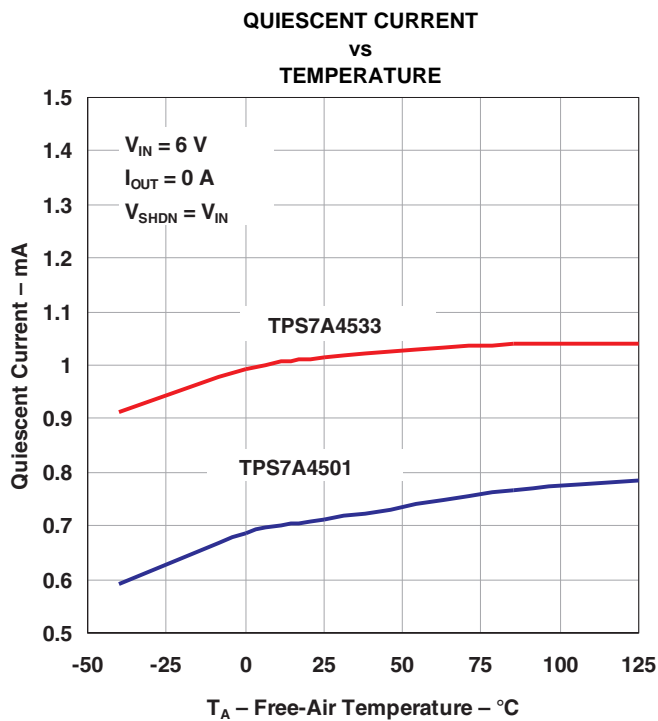

Figure 3.

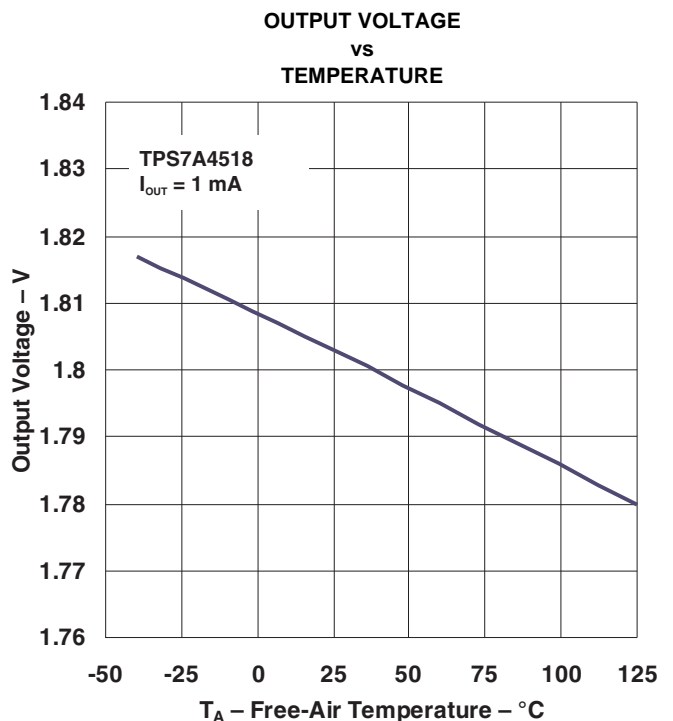

Figure 4.

TYPICAL CHARACTERISTICS (continued)

OUTPUT VOLTAGE
vs
TEMPERATURE

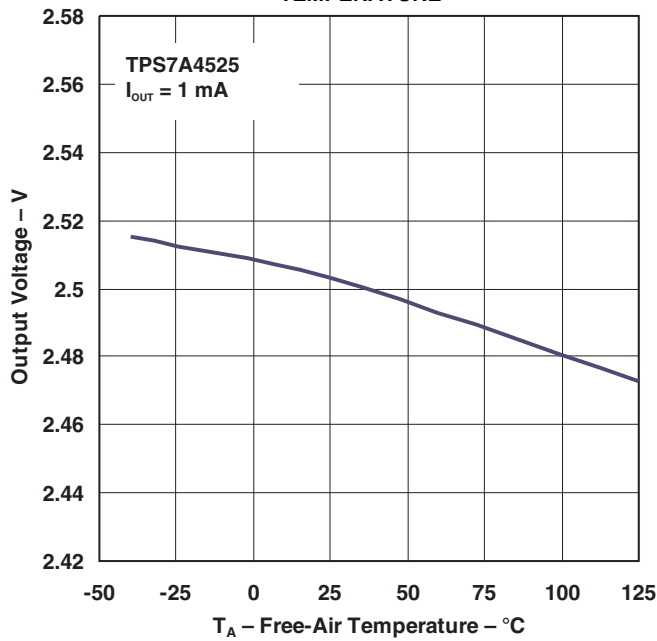

Figure 5.

OUTPUT VOLTAGE
vs
TEMPERATURE

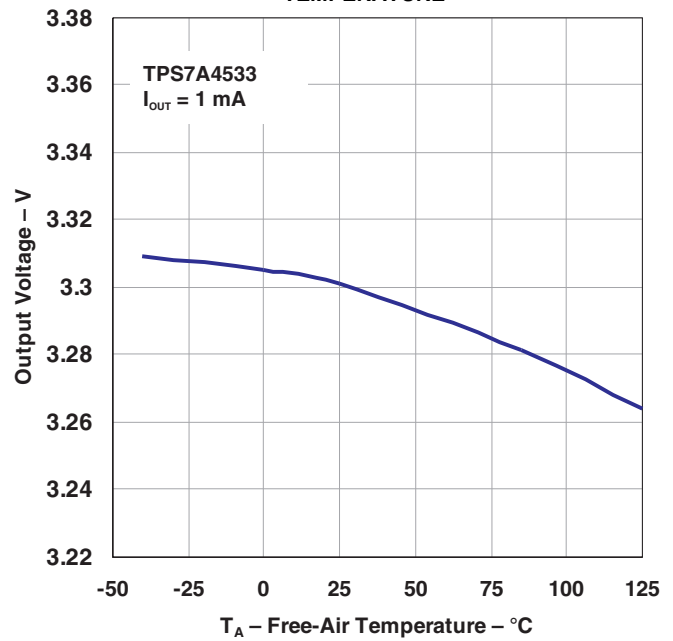

Figure 6.

OUTPUT VOLTAGE
vs
TEMPERATURE

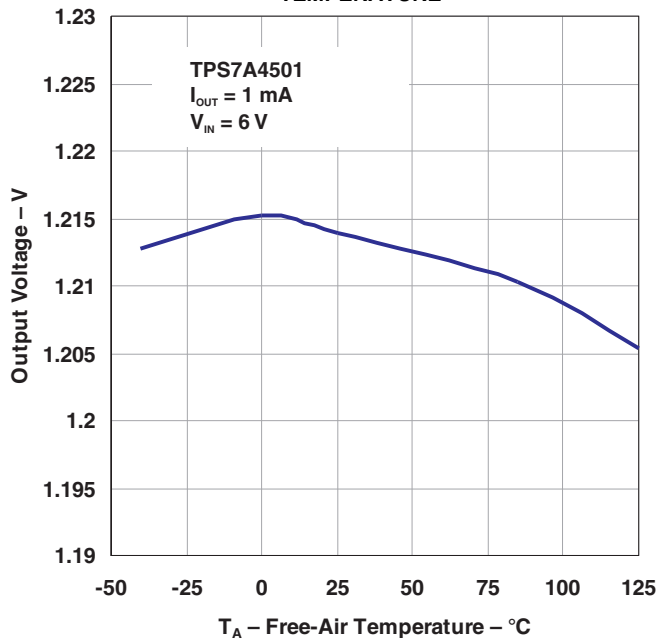

Figure 7.

QUIESCENT CURRENT
vs
INPUT VOLTAGE

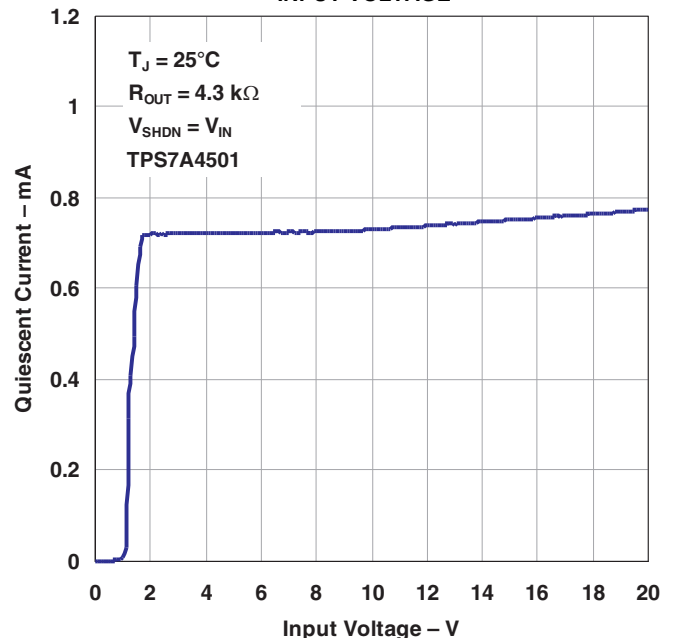

Figure 8.

TYPICAL CHARACTERISTICS (continued)

GROUND CURRENT
vs
INPUT VOLTAGE

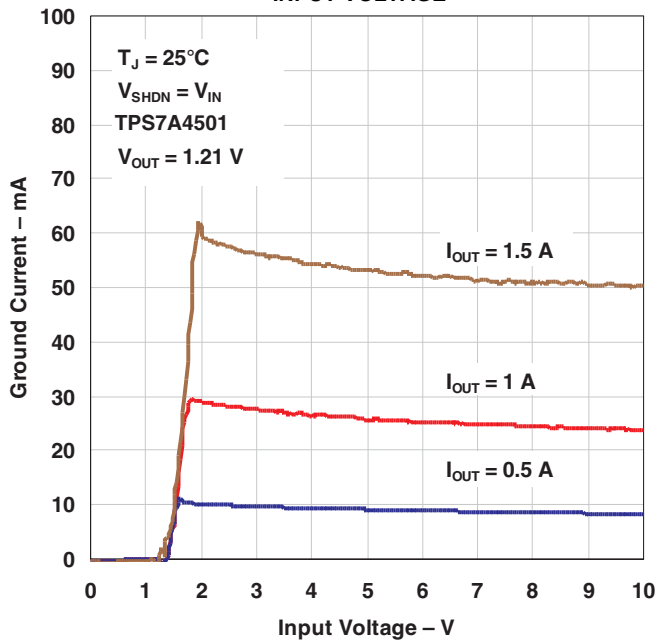

Figure 9.

GROUND CURRENT
vs
INPUT VOLTAGE

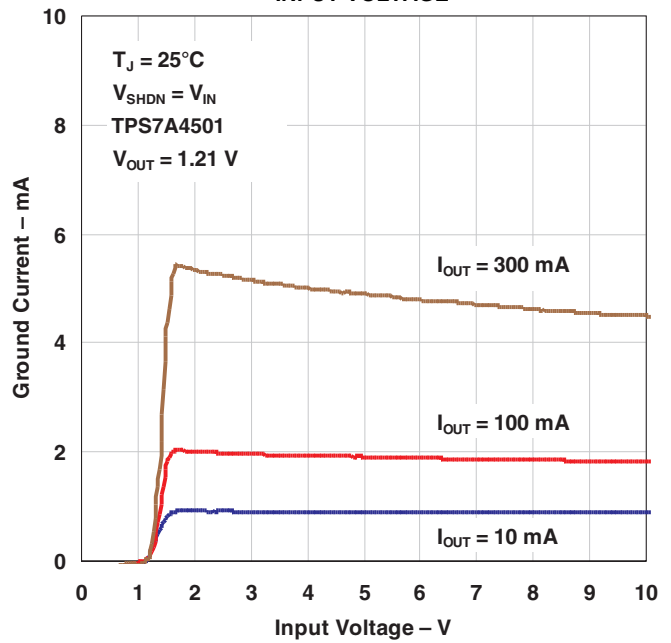

Figure 10.

GROUND CURRENT
vs
INPUT VOLTAGE

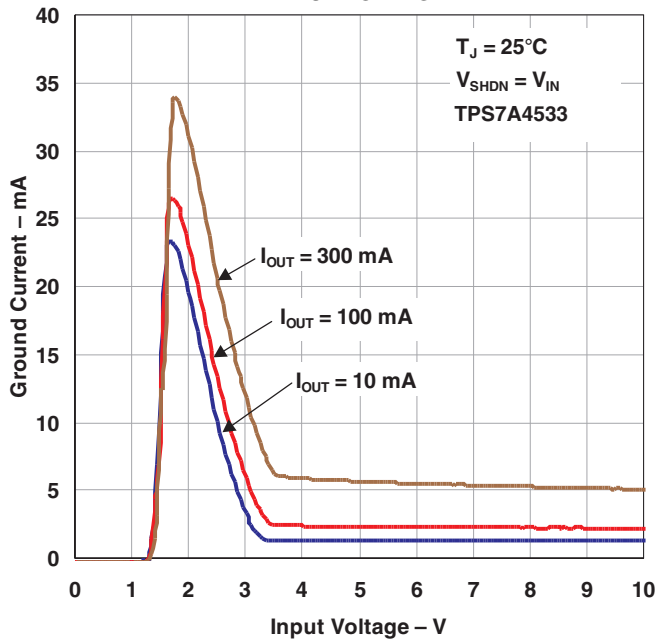

Figure 11.

GROUND CURRENT
vs
INPUT VOLTAGE

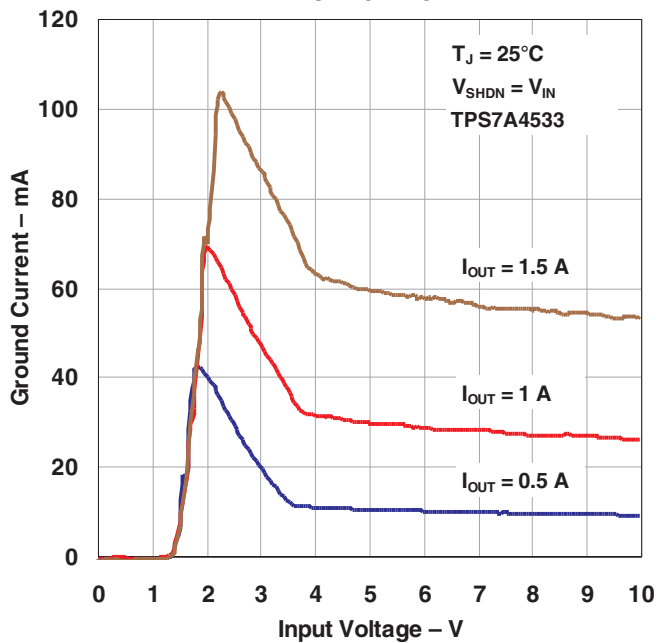

Figure 12.

TYPICAL CHARACTERISTICS (continued)

GROUND CURRENT
vs
OUTPUT CURRENT

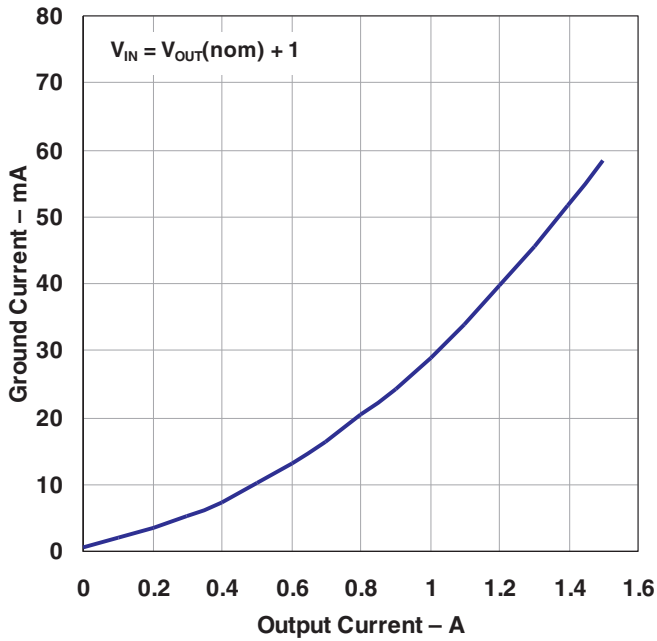

Figure 13.

SHDN INPUT CURRENT
vs
TEMPERATURE

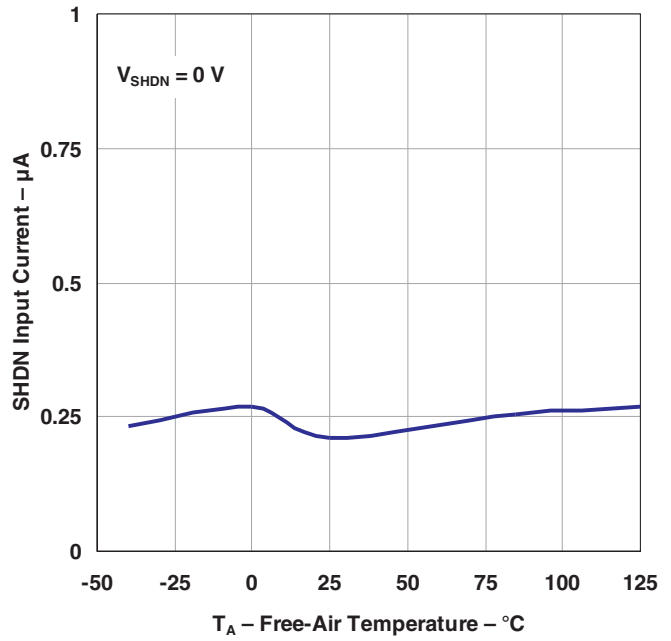

Figure 14.

SHDN INPUT CURRENT
vs
SHDN INPUT VOLTAGE

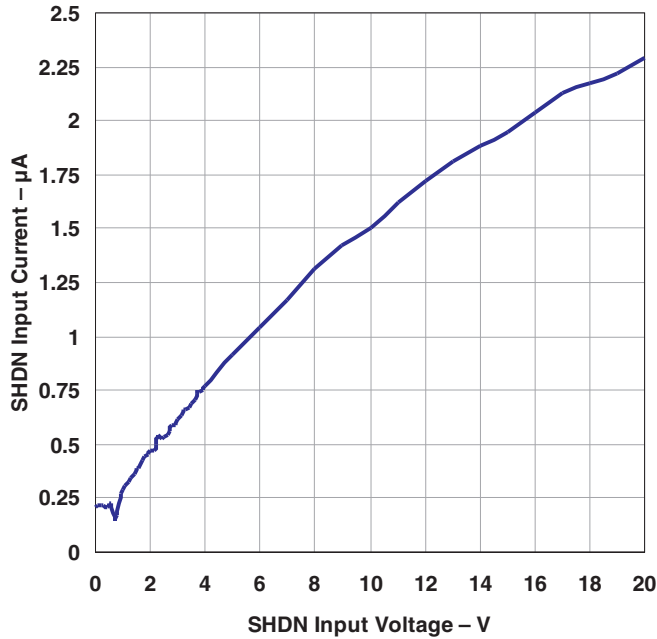

Figure 15.

SHDN THRESHOLD (OFF TO ON)
vs
TEMPERATURE

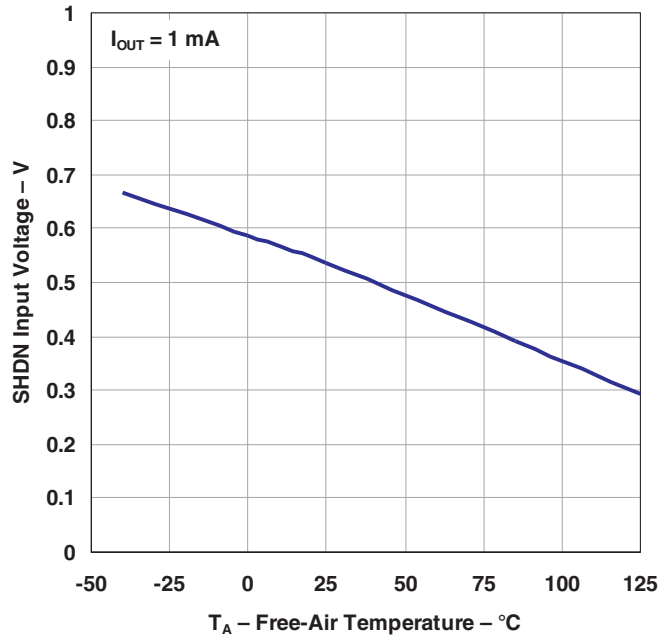

Figure 16.

TYPICAL CHARACTERISTICS (continued)

SHDN THRESHOLD (ON TO OFF)
vs
TEMPERATURE

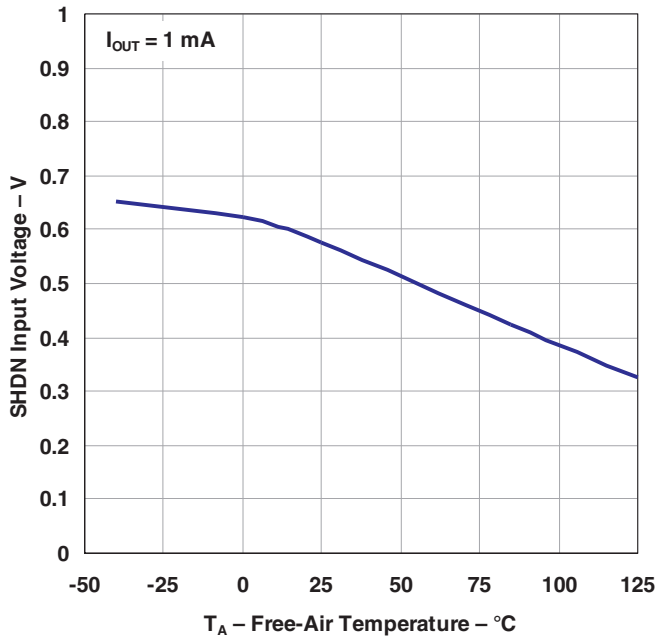

Figure 17.

ADJ BIAS CURRENT
vs
TEMPERATURE

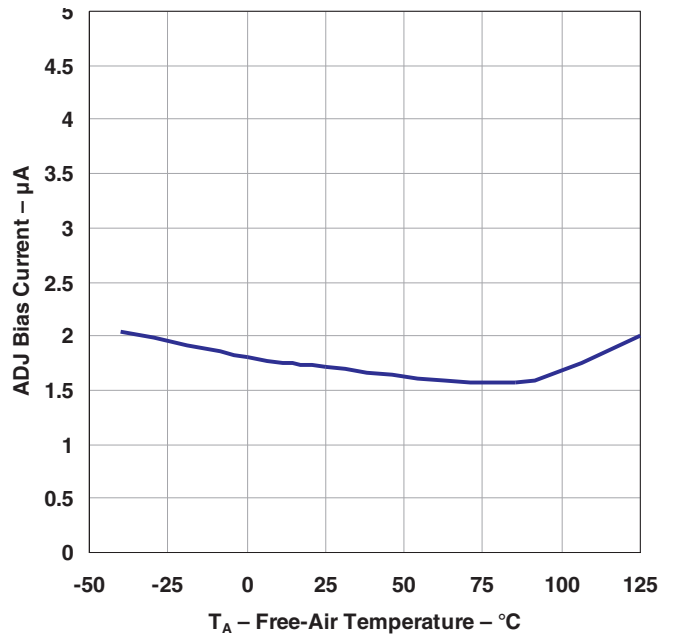

Figure 18.

CURRENT LIMIT
vs
INPUT/OUTPUT DIFFERENTIAL VOLTAGE

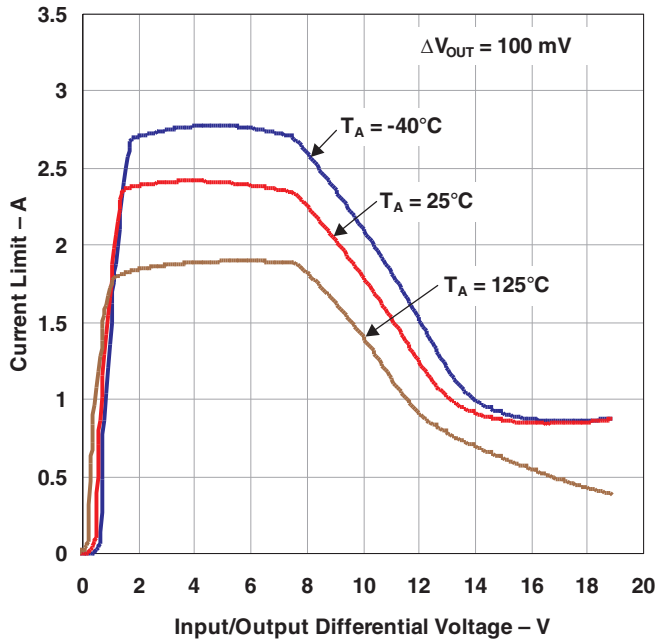

Figure 19.

CURRENT LIMIT
vs
TEMPERATURE

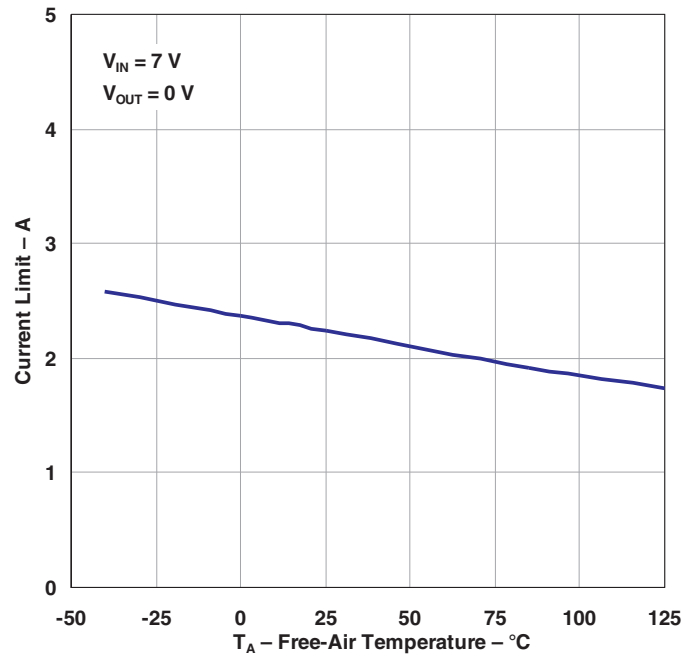

Figure 20.

TYPICAL CHARACTERISTICS (continued)

REVERSE OUTPUT CURRENT
vs
OUTPUT VOLTAGE

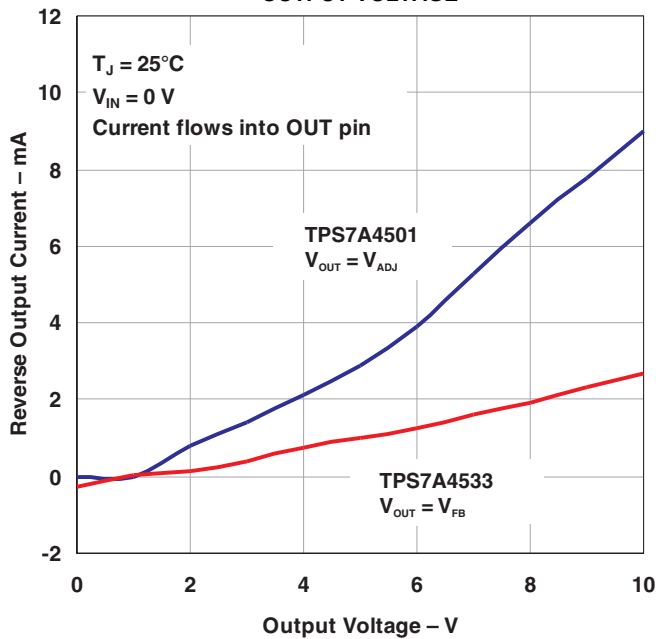

Figure 21.

REVERSE OUTPUT CURRENT
vs
TEMPERATURE

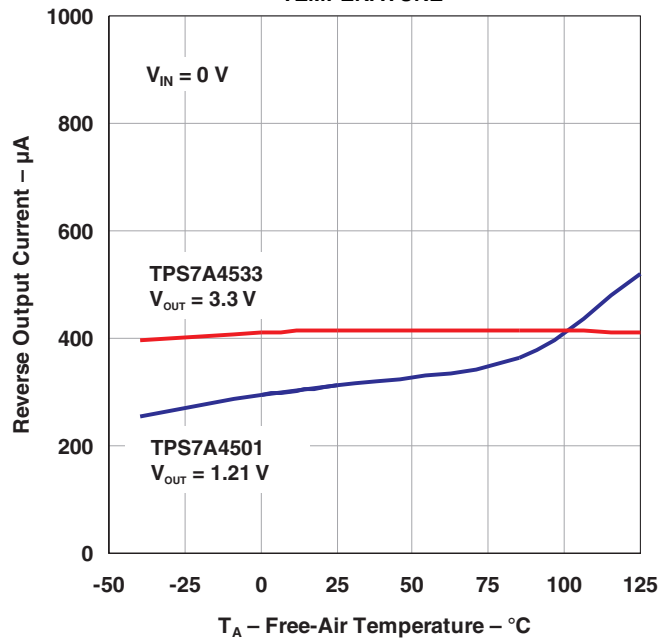

Figure 22.

RIPPLE REJECTION
vs
FREQUENCY

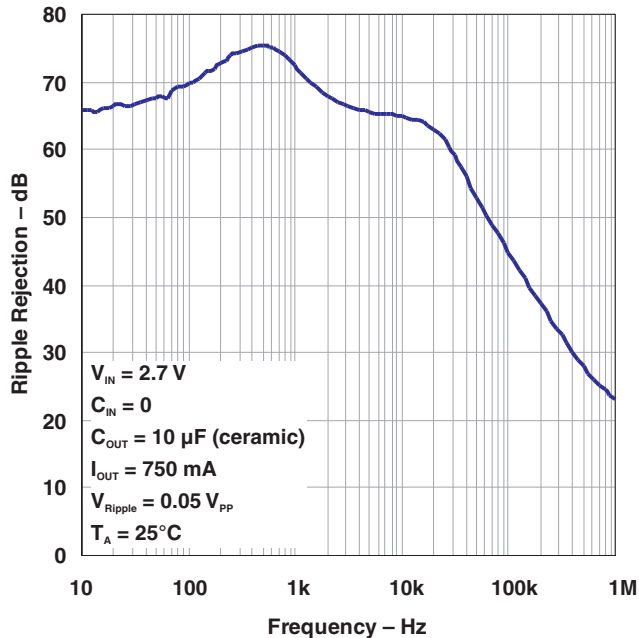

Figure 23.

LOAD REGULATION
vs
TEMPERATURE

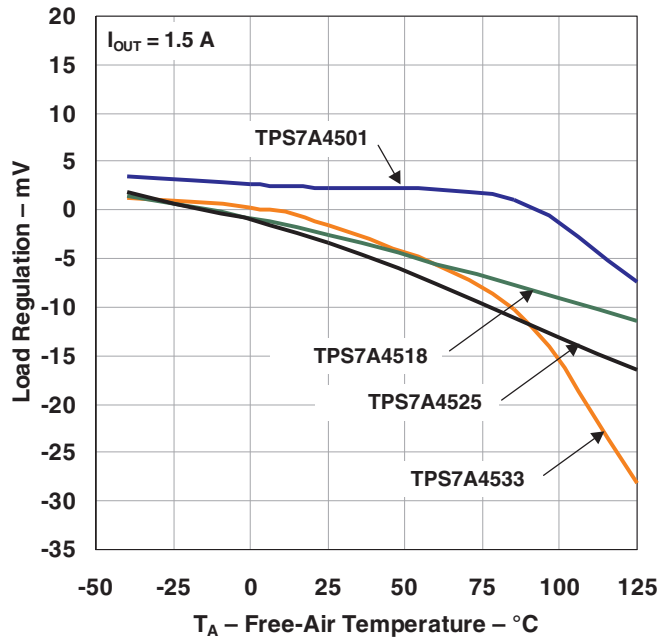

Figure 24.

TYPICAL CHARACTERISTICS (continued)

OUTPUT NOISE VOLTAGE
vs
FREQUENCY

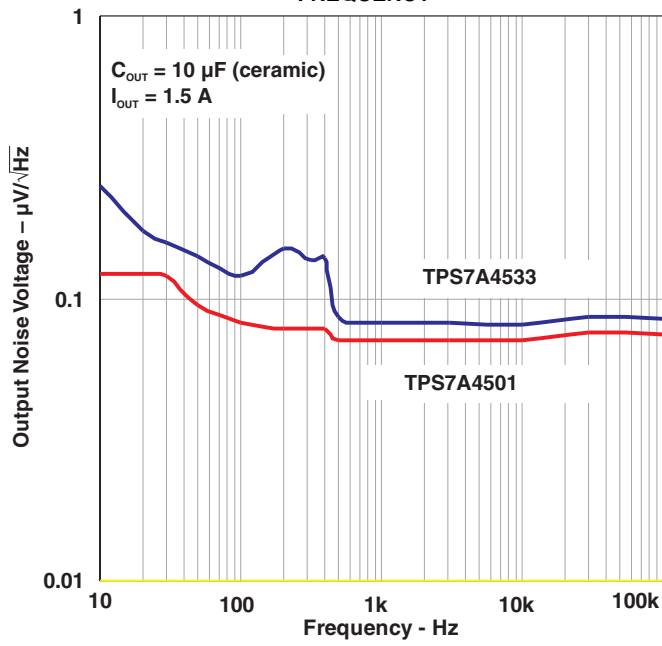

Figure 25.

LOAD TRANSIENT RESPONSE

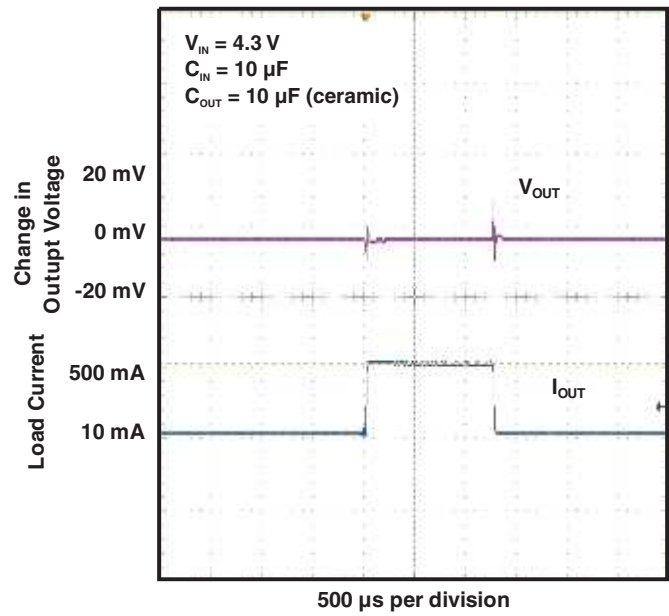
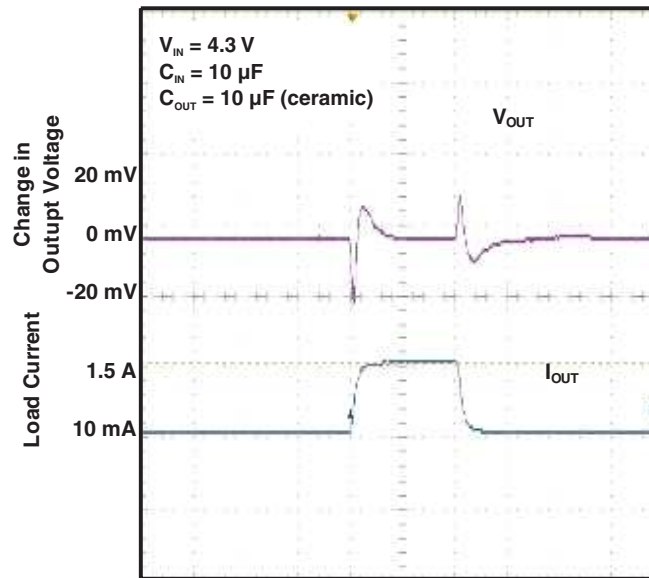

Figure 26.

LOAD TRANSIENT RESPONSE



500 μs per division

Figure 27.

APPLICATION INFORMATION

The TPS7A4501 is a 1.5-A low-dropout regulator optimized for fast transient response. The device is capable of supplying 1.5 A at a dropout voltage of 300 mV. The low operating quiescent current (1 mA) drops to less than 1 μ A in shutdown. In addition to the low quiescent current, the TPS7A4501 regulator incorporates several protection features that makes it ideal for use in battery-powered systems. The device is protected against both reverse input and reverse

output voltages. In battery-backup applications where the output can be held up by a backup battery when the input is pulled to ground, the TPS7A4501 acts as if it has a diode in series with its output and prevents reverse current flow. Additionally, in dual-supply applications where the regulator load is returned to a negative supply, the output can be pulled below ground by as much as (20 V - V_{IN}) and still allow the device to start and operate.

Typical Applications

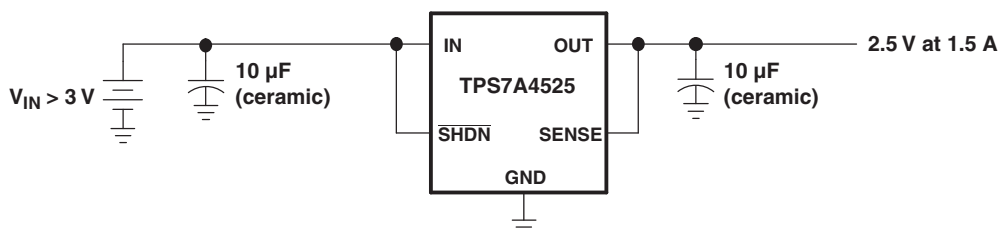
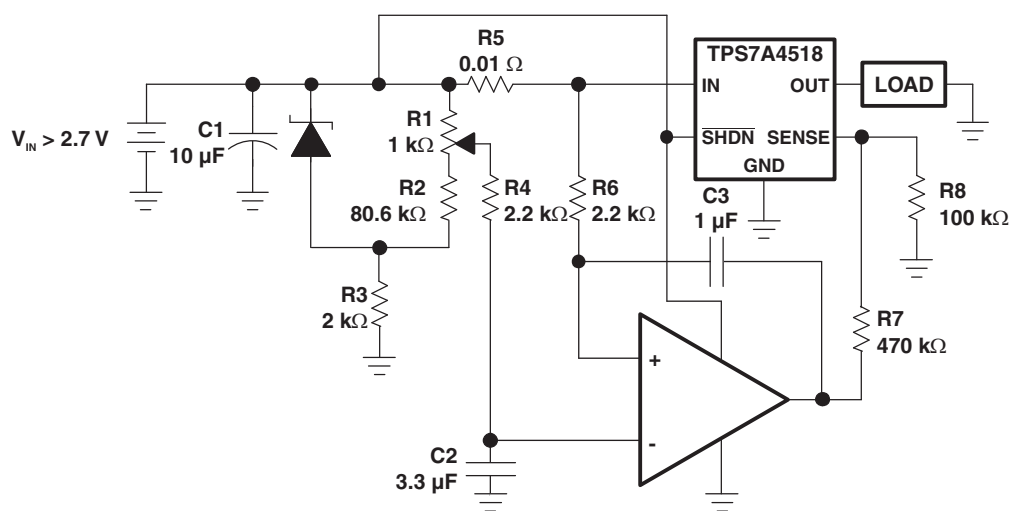
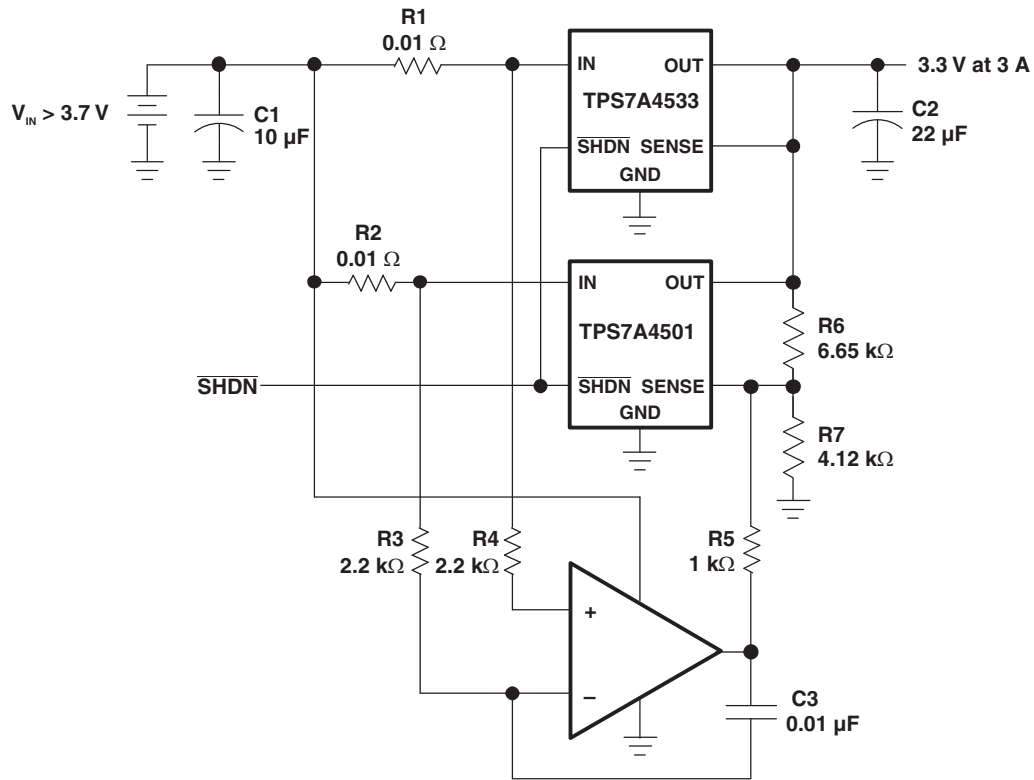

Figure 29. 3.3 V to 2.5 V Regulator



NOTE: All capacitors are ceramic.

Figure 30. Adjustable Current Source



NOTE: All capacitors are ceramic.

Figure 31. Paralleling Regulators for Higher Output Current

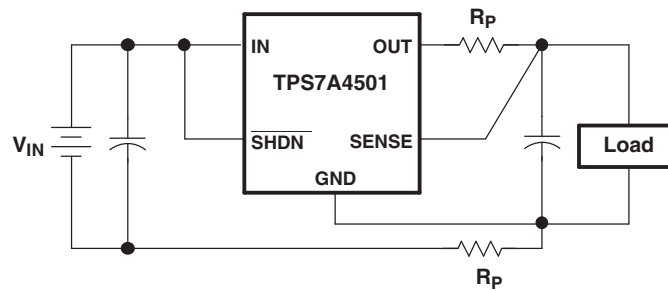
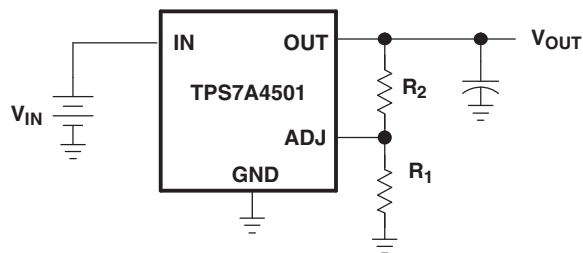

Figure 32. Kelvin Sense Connection

Adjustable Operation

The adjustable TPS7A4501 has an output voltage range of 1.21 V to 20 V. The output voltage is set by the ratio of two external resistors as shown in Figure 33. The device maintains the voltage at the ADJ pin at 1.21 V referenced to ground. The current in R1 is then equal to $(1.21 \text{ V}/R1)$, and the current in R2 is the current in R1 plus the ADJ pin bias current. The ADJ pin bias current, 3 μA at 25°C, flows through R2 into the ADJ pin. The output voltage can be calculated using the formula shown in Figure 33. The value of R1 should be less than 4.17 k Ω to minimize errors in the output voltage caused by the ADJ pin bias current. Note that in shutdown the output is turned off, and the divider current is zero.



$$V_{OUT} = 1.21 \text{ V} \left(1 + \frac{R2}{R1} \right) + (I_{ADJ})(R2)$$

$$V_{ADJ} = 1.21 \text{ V}$$

$$I_{ADJ} = 3 \mu\text{A at } 25^\circ\text{C}$$

$$\text{Output range} = 1.21 \text{ V to } 20 \text{ V}$$

Figure 33. Adjustable Operation

The adjustable device is tested and specified with the ADJ pin tied to the OUT pin for an output voltage of 1.21 V. Specifications for output voltages greater than 1.21 V are proportional to the ratio of the desired output voltage to 1.21 V: $V_{OUT}/1.21 \text{ V}$. For example, load regulation for an output current change of 1 mA to 1.5 A is -3 mV (typ) at $V_{OUT} = 1.21 \text{ V}$. At $V_{OUT} = 5 \text{ V}$, load regulation is:

$$(5 \text{ V}/1.21 \text{ V})(-3 \text{ mV}) = -12.4 \text{ mV}$$

Output Capacitance and Transient Response

The TPS7A4501 regulator is designed to be stable with a wide range of output capacitors. The ESR of the output capacitor affects stability, most notably with small capacitors. A minimum output capacitor of 10 μF with an ESR of 3 Ω or less is recommended to prevent oscillations. Larger values of output capacitance can decrease the peak deviations and provide improved transient response for larger load current changes. Bypass capacitors, used to decouple individual components powered by the TPS7A4501, increase the effective output capacitor value.

Extra consideration must be given to the use of ceramic capacitors. Ceramic capacitors are manufactured with a variety of dielectrics, each with different behavior over temperature and applied voltage. The most common dielectrics used are Z5U, Y5V, X5R and X7R. The Z5U and Y5V dielectrics are good for providing high capacitances in a small package, but exhibit strong voltage and temperature coefficients. When used with a 5-V regulator, a 10- μF Y5V capacitor can exhibit an effective value as low as 1 μF to 2 μF over the operating temperature range. The X5R and X7R dielectrics result in more stable characteristics and are more suitable for use as the output capacitor. The X7R type has better stability across temperature, while the X5R is less expensive and is available in higher values.

Voltage and temperature coefficients are not the only sources of problems. Some ceramic capacitors have a piezoelectric response. A piezoelectric device generates voltage across its terminals due to mechanical stress, similar to the way a piezoelectric accelerometer or microphone works. For a ceramic capacitor the stress can be induced by vibrations in the system or thermal transients.

Overload Recovery

Like many IC power regulators, the TPS7A4501 has safe operating area protection. The safe area protection decreases the current limit as input-to-output voltage increases and keeps the power transistor inside a safe operating region for all values of input-to-output voltage. The protection is designed to provide some output current at all values of input-to-output voltage up to the device breakdown.

When power is first turned on, as the input voltage rises, the output follows the input, allowing the regulator to start up into very heavy loads. During start up, as the input voltage is rising, the input-to-output voltage differential is small, allowing the regulator to supply large output currents. With a high input voltage, a problem can occur wherein removal of an output short does not allow the output voltage to recover. Other regulators also exhibit this phenomenon, so it is not unique to the TPS7A4501.

The problem occurs with a heavy output load when the input voltage is high and the output voltage is low. Common situations occur immediately after the removal of a short circuit or when the shutdown pin is pulled high after the input voltage has already been turned on. The load line for such a load may intersect the output current curve at two points. If this happens, there are two stable output operating points for the regulator. With this double intersection, the input power supply may need to be cycled down to zero and brought up again to make the output recover.

Output Voltage Noise

The TPS7A4501 regulator has been designed to provide low output voltage noise over the 10-Hz to 100-kHz bandwidth while operating at full load. Output voltage noise is typically $35 \text{ nV}/\sqrt{\text{Hz}}$ over this frequency bandwidth for the TPS7A4501. For higher output voltages (generated by using a resistor divider), the output voltage noise is gained up accordingly. This results in RMS noise over the 10-Hz to 100-kHz bandwidth of $14 \mu\text{V}_{\text{RMS}}$.

Higher values of output voltage noise may be measured when care is not exercised with regard to circuit layout and testing. Crosstalk from nearby traces can induce unwanted noise onto the output of the TPS7A4501. Power-supply ripple rejection must also be considered; the TPS7A4501 regulator does not have unlimited power-supply rejection and passes a small portion of the input noise through to the output.

Thermal Considerations

The power handling capability of the device is limited by the maximum rated junction temperature (125°C). The power dissipated by the device is made up of two components:

1. Output current multiplied by the input/output voltage differential: $I_{\text{OUT}}(V_{\text{IN}} - V_{\text{OUT}})$
2. GND pin current multiplied by the input voltage: $I_{\text{GND}}V_{\text{IN}}$.

The GND pin current can be found using the GND Pin Current graphs in *Typical Characteristics*. Power dissipation is equal to the sum of the two components listed above.

The TPS7A45xx series regulators have internal thermal limiting designed to protect the device during overload conditions. For continuous normal conditions, the maximum junction temperature rating of 125°C must not be exceeded. It is important to give careful consideration to all sources of thermal resistance from junction to ambient. Additional heat sources mounted nearby must also be considered.

For surface-mount devices, heat sinking is accomplished by using the heat-spreading capabilities of the PC board and its copper traces. Copper board stiffeners and plated through-holes can also be used to spread the heat generated by power devices.

Calculating Junction Temperature

Example: Given an output voltage of 3.3 V, an input voltage range of 4 V to 6 V, an output current range of 0 mA to 500 mA, and a maximum case temperature of 50°C, what is the maximum junction temperature?

The power dissipated by the device is equal to:

$$I_{OUT(MAX)}(V_{IN(MAX)} - V_{OUT}) + I_{GND}(V_{IN(MAX)})$$

where,

$$I_{OUT(MAX)} = 500 \text{ mA}$$

$$V_{IN(MAX)} = 6 \text{ V}$$

$$I_{GND} \text{ at } (I_{OUT} = 500 \text{ mA}, V_{IN} = 6 \text{ V}) = 10 \text{ mA}$$

So,

$$P = 500 \text{ mA} \times (6 \text{ V} - 3.3 \text{ V}) + 10 \text{ mA} \times 6 \text{ V} = 1.41 \text{ W}$$

Using a U package, the thermal resistance is about 14.7°C/W. So the junction temperature rise above case is approximately equal to:

$$1.41 \text{ W} \times 14.7^\circ\text{C/W} = 20.7^\circ\text{C}$$

The maximum junction temperature is then be equal to the maximum junction-temperature rise above case plus the maximum case temperature or:

$$T_{JMAX} = 50^\circ\text{C} + 20.7^\circ\text{C} = 70.7^\circ\text{C}$$

Protection Features

The TPS7A4501 regulator incorporates several protection features which makes it ideal for use in battery-powered circuits. In addition to the normal protection features associated with monolithic regulators, such as current limiting and thermal limiting, the device is protected against reverse input voltages, reverse output voltages and reverse voltages from output to input.

Current limit protection and thermal overload protection are intended to protect the device against current overload conditions at the output of the device. For normal operation, the junction temperature should not exceed 125°C.

The input of the device withstands reverse voltages of 20 V. Current flow into the device is limited to less than 1 mA (typically less than 100 μ A), and no negative voltage appears at the output. The device protects both itself and the load. This provides protection against batteries that can be plugged in backward.

The output of the TPS7A4501 can be pulled below ground without damaging the device. If the input is left open circuit or grounded, the output can be pulled below ground by 20 V. The output acts like an open circuit; no current flows out of the pin. If the input is powered by a voltage source, the output sources the short-circuit current of the device and protects itself by thermal limiting. In this case, grounding the SHDN pin turns off the device and stops the output from sourcing the short-circuit current.





The ADJ pin of the adjustable device can be pulled above or below ground by as much as 7 V without damaging the device. If the input is left open circuit or grounded, the ADJ pin acts like an open circuit when pulled below ground and like a large resistor (typically 5 k Ω) in series with a diode when pulled above ground.

In situations where the ADJ pin is connected to a resistor divider that would pull the ADJ pin above its 7-V clamp voltage if the output is pulled high, the ADJ pin input current must be limited to less than 5 mA. For example, a resistor divider is used to provide a regulated 1.5-V output from the 1.21-V reference when the output is forced to 20 V. The top resistor of the resistor divider must be chosen to limit the current into the ADJ pin to less than 5 mA when the ADJ pin is at 7 V. The 13-V difference between OUT and ADJ divided by the 5-mA maximum current into the ADJ pin yields a minimum top resistor value of 2.6 k Ω .

In circuits where a backup battery is required, several different input/output conditions can occur. The output voltage may be held up while the input is either pulled to ground, pulled to some intermediate voltage, or is left open circuit.

When the IN pin of the TPS7A4501 is forced below the OUT pin or the OUT pin is pulled above the IN pin, input current typically drops to less than 2 μ A. This can happen if the input of the device is connected to a discharged (low voltage) battery and the output is held up by either a backup battery or a second regulator circuit. The state of the SHDN pin has no effect on the reverse output current when the output is pulled above the input.

PACKAGING INFORMATION

Orderable Device	Status (1)	Package Type	Package Drawing	Pins	Package Qty	Eco Plan (2)	Lead/Ball Finish	MSL Peak Temp (3)	Op Temp (°C)	Top-Side Markings (4)	Samples
5962-1222401Q9A	ACTIVE	XCEPT	KGD	0	100	TBD	Call TI	Call TI	-55 to 125		
5962-1222401QHA	ACTIVE	CFP	U	10	1	TBD	Call TI	Call TI	-55 to 125	1222401QHA 7A4501MU	
TPS7A4501MKGD1	ACTIVE	XCEPT	KGD	0	100	TBD	Call TI	N / A for Pkg Type	-55 to 125		
TPS7A4501MUB	ACTIVE	CFP	U	10	1	TBD	A42	N / A for Pkg Type	-55 to 125	1222401QHA 7A4501MU	

(1) The marketing status values are defined as follows:

ACTIVE: Product device recommended for new designs.

LIFEBUY: TI has announced that the device will be discontinued, and a lifetime-buy period is in effect.

NRND: Not recommended for new designs. Device is in production to support existing customers, but TI does not recommend using this part in a new design.

PREVIEW: Device has been announced but is not in production. Samples may or may not be available.

OBSOLETE: TI has discontinued the production of the device.

(2) Eco Plan - The planned eco-friendly classification: Pb-Free (RoHS), Pb-Free (RoHS Exempt), or Green (RoHS & no Sb/Br) - please check <http://www.ti.com/productcontent> for the latest availability information and additional product content details.

TBD: The Pb-Free/Green conversion plan has not been defined.

Pb-Free (RoHS): TI's terms "Lead-Free" or "Pb-Free" mean semiconductor products that are compatible with the current RoHS requirements for all 6 substances, including the requirement that lead not exceed 0.1% by weight in homogeneous materials. Where designed to be soldered at high temperatures, TI Pb-Free products are suitable for use in specified lead-free processes.

Pb-Free (RoHS Exempt): This component has a RoHS exemption for either 1) lead-based flip-chip solder bumps used between the die and package, or 2) lead-based die adhesive used between the die and leadframe. The component is otherwise considered Pb-Free (RoHS compatible) as defined above.

Green (RoHS & no Sb/Br): TI defines "Green" to mean Pb-Free (RoHS compatible), and free of Bromine (Br) and Antimony (Sb) based flame retardants (Br or Sb do not exceed 0.1% by weight in homogeneous material)

(3) MSL, Peak Temp. -- The Moisture Sensitivity Level rating according to the JEDEC industry standard classifications, and peak solder temperature.

(4) Only one of markings shown within the brackets will appear on the physical device.

Important Information and Disclaimer: The information provided on this page represents TI's knowledge and belief as of the date that it is provided. TI bases its knowledge and belief on information provided by third parties, and makes no representation or warranty as to the accuracy of such information. Efforts are underway to better integrate information from third parties. TI has taken and continues to take reasonable steps to provide representative and accurate information but may not have conducted destructive testing or chemical analysis on incoming materials and chemicals. TI and TI suppliers consider certain information to be proprietary, and thus CAS numbers and other limited information may not be available for release.

In no event shall TI's liability arising out of such information exceed the total purchase price of the TI part(s) at issue in this document sold by TI to Customer on an annual basis.

OTHER QUALIFIED VERSIONS OF TPS7A4501M :

- Catalog: [TPS7A4501](#)

NOTE: Qualified Version Definitions:

- Catalog - TI's standard catalog product

IMPORTANT NOTICE

Texas Instruments Incorporated and its subsidiaries (TI) reserve the right to make corrections, enhancements, improvements and other changes to its semiconductor products and services per JESD46, latest issue, and to discontinue any product or service per JESD48, latest issue. Buyers should obtain the latest relevant information before placing orders and should verify that such information is current and complete. All semiconductor products (also referred to herein as "components") are sold subject to TI's terms and conditions of sale supplied at the time of order acknowledgment.

TI warrants performance of its components to the specifications applicable at the time of sale, in accordance with the warranty in TI's terms and conditions of sale of semiconductor products. Testing and other quality control techniques are used to the extent TI deems necessary to support this warranty. Except where mandated by applicable law, testing of all parameters of each component is not necessarily performed.

TI assumes no liability for applications assistance or the design of Buyers' products. Buyers are responsible for their products and applications using TI components. To minimize the risks associated with Buyers' products and applications, Buyers should provide adequate design and operating safeguards.

TI does not warrant or represent that any license, either express or implied, is granted under any patent right, copyright, mask work right, or other intellectual property right relating to any combination, machine, or process in which TI components or services are used. Information published by TI regarding third-party products or services does not constitute a license to use such products or services or a warranty or endorsement thereof. Use of such information may require a license from a third party under the patents or other intellectual property of the third party, or a license from TI under the patents or other intellectual property of TI.

Reproduction of significant portions of TI information in TI data books or data sheets is permissible only if reproduction is without alteration and is accompanied by all associated warranties, conditions, limitations, and notices. TI is not responsible or liable for such altered documentation. Information of third parties may be subject to additional restrictions.

Resale of TI components or services with statements different from or beyond the parameters stated by TI for that component or service voids all express and any implied warranties for the associated TI component or service and is an unfair and deceptive business practice. TI is not responsible or liable for any such statements.

Buyer acknowledges and agrees that it is solely responsible for compliance with all legal, regulatory and safety-related requirements concerning its products, and any use of TI components in its applications, notwithstanding any applications-related information or support that may be provided by TI. Buyer represents and agrees that it has all the necessary expertise to create and implement safeguards which anticipate dangerous consequences of failures, monitor failures and their consequences, lessen the likelihood of failures that might cause harm and take appropriate remedial actions. Buyer will fully indemnify TI and its representatives against any damages arising out of the use of any TI components in safety-critical applications.

In some cases, TI components may be promoted specifically to facilitate safety-related applications. With such components, TI's goal is to help enable customers to design and create their own end-product solutions that meet applicable functional safety standards and requirements. Nonetheless, such components are subject to these terms.

No TI components are authorized for use in FDA Class III (or similar life-critical medical equipment) unless authorized officers of the parties have executed a special agreement specifically governing such use.

Only those TI components which TI has specifically designated as military grade or "enhanced plastic" are designed and intended for use in military/aerospace applications or environments. Buyer acknowledges and agrees that any military or aerospace use of TI components which have **not** been so designated is solely at the Buyer's risk, and that Buyer is solely responsible for compliance with all legal and regulatory requirements in connection with such use.

TI has specifically designated certain components as meeting ISO/TS16949 requirements, mainly for automotive use. In any case of use of non-designated products, TI will not be responsible for any failure to meet ISO/TS16949.

Products

Audio	www.ti.com/audio
Amplifiers	amplifier.ti.com
Data Converters	dataconverter.ti.com
DLP® Products	www.dlp.com
DSP	dsp.ti.com
Clocks and Timers	www.ti.com/clocks
Interface	interface.ti.com
Logic	logic.ti.com
Power Mgmt	power.ti.com
Microcontrollers	microcontroller.ti.com
RFID	www.ti-rfid.com
OMAP Applications Processors	www.ti.com/omap
Wireless Connectivity	www.ti.com/wirelessconnectivity

Applications

Automotive and Transportation	www.ti.com/automotive
Communications and Telecom	www.ti.com/communications
Computers and Peripherals	www.ti.com/computers
Consumer Electronics	www.ti.com/consumer-apps
Energy and Lighting	www.ti.com/energy
Industrial	www.ti.com/industrial
Medical	www.ti.com/medical
Security	www.ti.com/security
Space, Avionics and Defense	www.ti.com/space-avionics-defense
Video and Imaging	www.ti.com/video

TI E2E Community

e2e.ti.com