

Quad Channel High Speed ESD Protection Device

 Check for Samples: [TPD4E1B06](#)

FEATURES

- Provides System Level ESD Protection for Low-Voltage IO Interfaces
- IEC 61000-4-2 Level 4
 - ±12kV (Contact discharge)
 - ±15kV (Air-gap discharge)
- IO Capacitance 1.0pF (Typ)
- DC Breakdown Voltage 7V (Min)
- Ultra low Leakage Current 10nA (Max)
- Low ESD Clamping Voltage
- Industrial Temperature Range: –40°C to 125°C
- Small, Easy-to-Route DCK package

APPLICATIONS

- USB2.0
- HDMI control lines
- MIPI Bus
- LVDS
- SATA

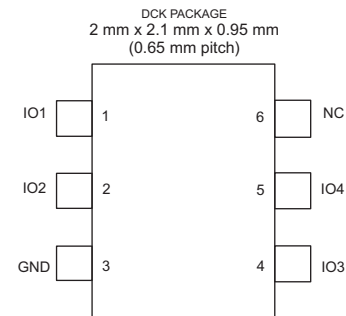

DESCRIPTION

The TPD4E1B06 is a quad channel ultra low cap ESD protection device. It offers ±12KV IEC air-gap and ±15KV contact ESD protection. Its 1.0pF line capacitance makes it suitable for a wide range of applications. Typical application areas are HDMI, USB2.0, Ethernet, and 1394 interfaces.

ORDERING INFORMATION

T _A	PACKAGE ⁽¹⁾⁽²⁾		ORDERABLE PART NUMBER	TOP-SIDE MARKING
–40°C to 125°C	3000	Tape and reel	TPD4E1B06DCKR	BYI

(1) Package drawings, thermal data, and symbolization are available at www.ti.com/packaging.

(2) For the most current package and ordering information, see the Package Option Addendum at the end of this document, or see the TI Web site at www.ti.com.



Please be aware that an important notice concerning availability, standard warranty, and use in critical applications of Texas Instruments semiconductor products and disclaimers thereto appears at the end of this data sheet.



These devices have limited built-in ESD protection. The leads should be shorted together or the device placed in conductive foam during storage or handling to prevent electrostatic damage to the MOS gates.

FUNCTIONAL BLOCK DIAGRAM

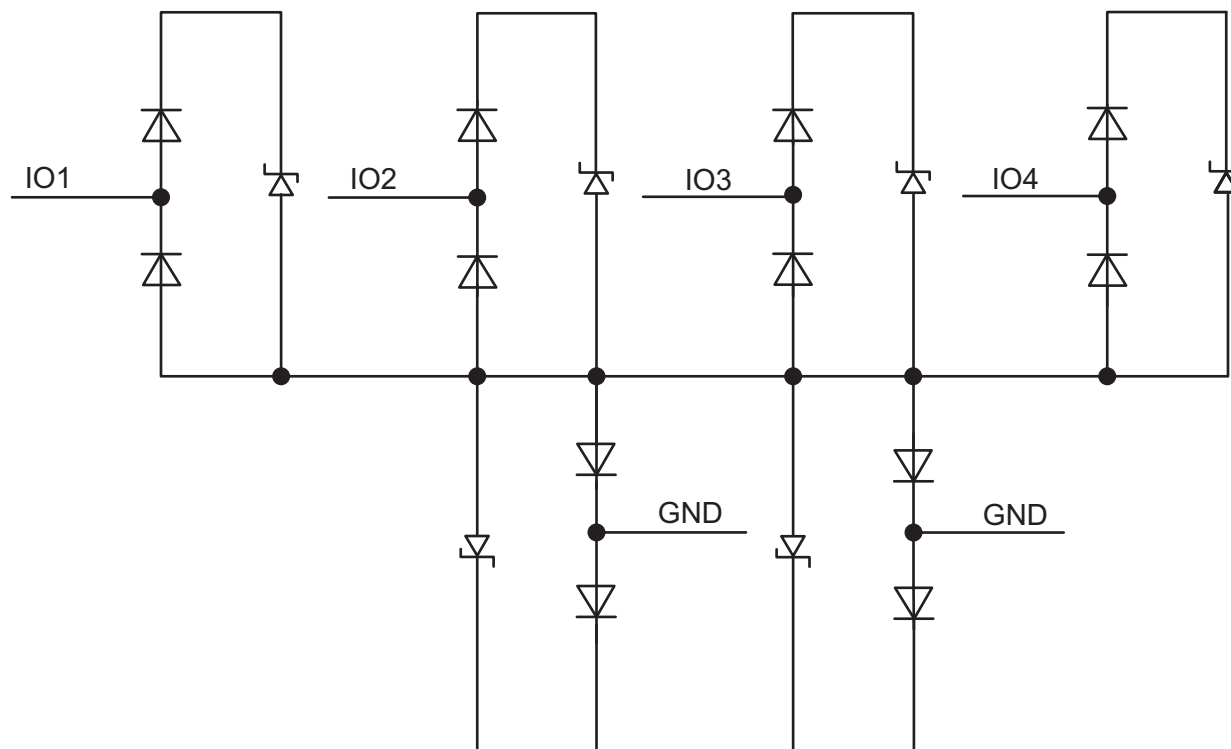

Figure 1. Circuit Schematic Diagram

TERMINAL FUNCTIONS

PIN			DESCRIPTION	USAGE
NAME	NUMBER	TYPE		
IO1	1	I/O	ESD protected channel	Connect to data line as close to the connector as possible
IO2	2	I/O		
IO3	4	I/O		
IO4	5	I/O		
NC	6	NC	No connect	Can be left floating, grounded, or connected to Vcc
GND	3	GND	Ground	Connect to ground

ABSOLUTE MAXIMUM RATINGS

over operating free-air temperature range (unless otherwise noted)

	MIN	MAX	UNIT
Operating temperature range	–40	125	°C
Storage temperature	–65	155	°C
IEC 61000-4-2 contact ESD		±12	kV
IEC 61000-4-2 air-gap ESD		±15	kV
I_{PP} , peak pulse current ($t_p = 8/20 \mu s$), IO pin to GND		3.5	A
P_{PP} , peak pulse power ($t_p = 8/20 \mu s$)		45	W

ELECTRICAL CHARACTERISTICS

over recommended operating free-air temperature range (unless otherwise noted)

PARAMETER	TEST CONDITION	MIN	TYP	MAX	UNIT
V_{RWM} Reverse stand-off voltage				5.5	V
V_{CLAMP} Clamp voltage with ESD strike, IO to GND	$I_{PP} = 1 \text{ A}$, $t_p = 8/20 \mu\text{Sec}$, from I/O to GND or GND to I/O		10.5		V
	$I_{PP} = 3 \text{ A}$, $t_p = 8/20 \mu\text{Sec}$, from I/O to GND or GND to I/O		14.5		V
R_{DYN} Dynamic resistance	$I_{TLP} = 10 \text{ A to } 20 \text{ A}$, I/O to GND		1		Ω
	$I_{TLP} = 10 \text{ A to } 20 \text{ A}$, GND to I/O		0.8		
C_L Line capacitance	$f = 1 \text{ MHz}$, $V_{BIAS} = 2.5 \text{ V}$		1		pF
V_{BR} Break-down voltage	$I_{IO} = 1 \text{ mA}$, from I/O to GND or GND to I/O	7		9.5	V
I_{LEAK} Leakage current	$V_{IO} = 5.0 \text{ V}$		1	10	nA

TYPICAL CHARACTERISTICS

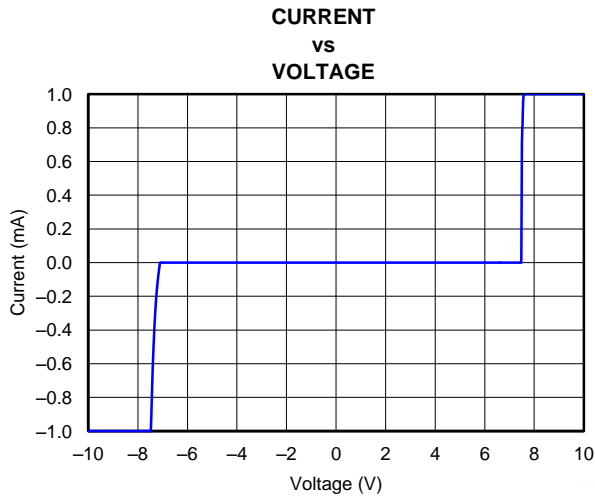

Figure 2. DC Voltage Sweep I-V Curve

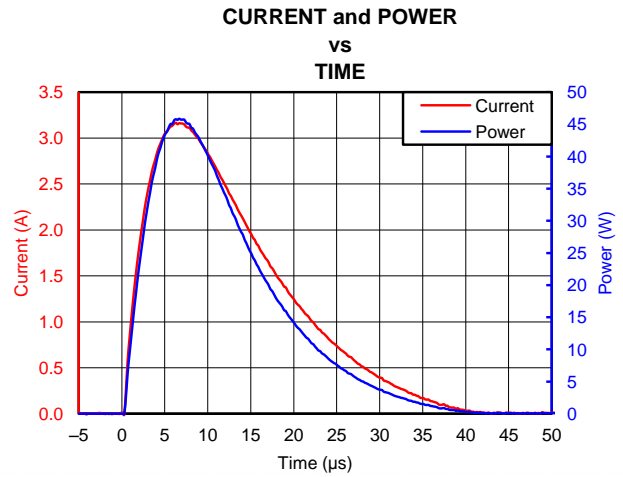

Figure 3. Surge Curve ($t_p = 8/20\mu s$), Pin IO to GND

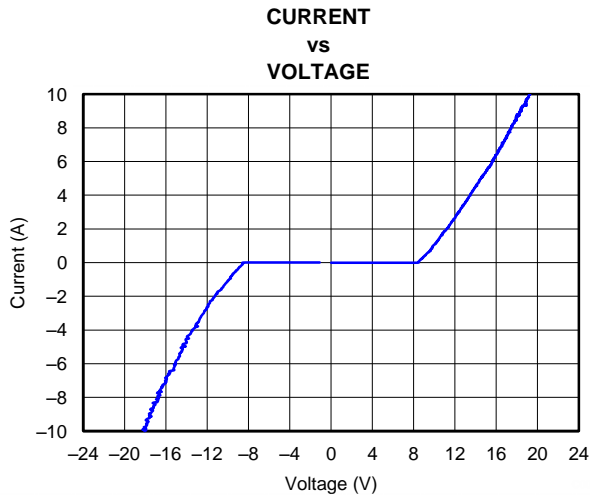

Figure 4. TLP Plot IO to GND

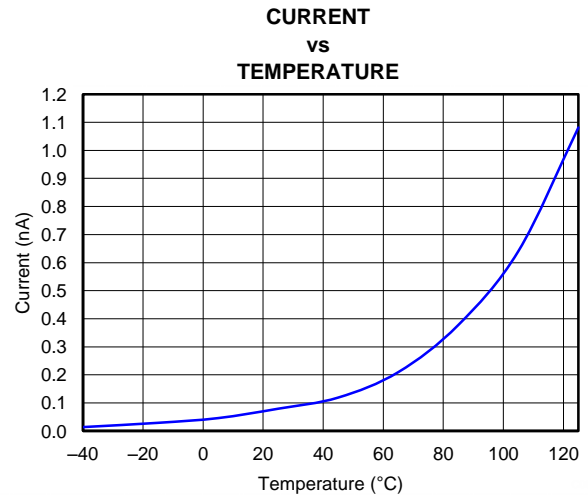

Figure 5. Leakage vs Temperature

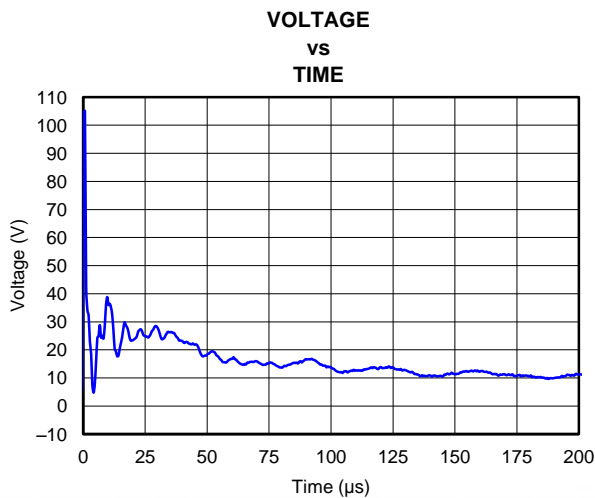

Figure 6. +8kV IEC Waveform

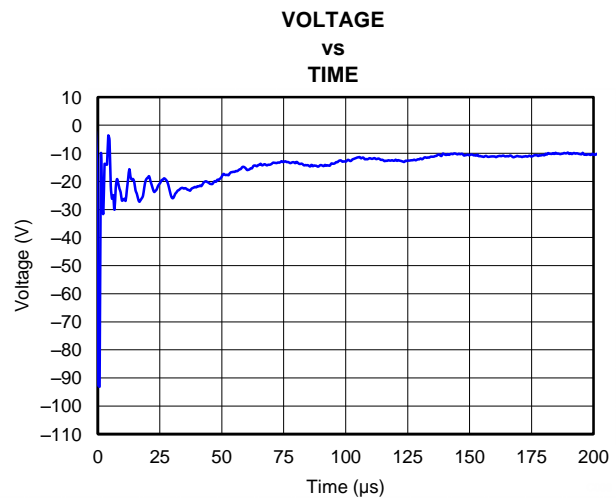

Figure 7. -8kV IEC Waveform

APPLICATION INFORMATION

The TPD4E1B06DCK offers a unique pinout that allows straight through routing with no stubs. [Figure 8](#) shows an example layout. Pins 1 & 2 and pins 4 & 5 are routed differentially. Pin 3 is routed to the ground plane. Pin 6 is not bonded internally in the device and does not need to be routed anywhere on the board. It is also okay if pin 6 is connected to power plane or a capacitor.

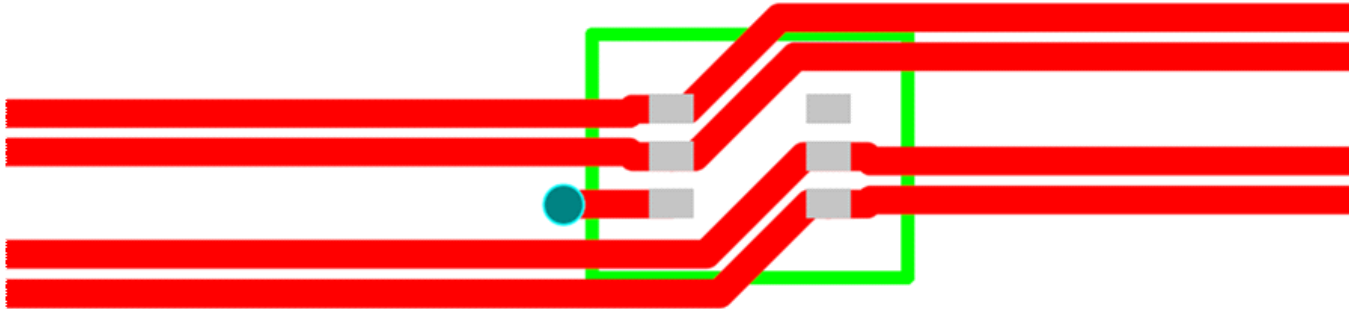

Figure 8. TPD4E1B06 Layout Example

REVISION HISTORY

Changes from Original (December 2012) to Revision A	Page
• Fixed "f" units typo from GHz to MHz for C_L parameter in ELECTRICAL CHARACTERISTICS table.	3

PACKAGING INFORMATION

Orderable Device	Status (1)	Package Type	Package Drawing	Pins	Package Qty	Eco Plan (2)	Lead/Ball Finish	MSL Peak Temp (3)	Op Temp (°C)	Top-Side Markings (4)	Samples
TPD4E1B06DCKR	ACTIVE	SC70	DCK	6	3000	Green (RoHS & no Sb/Br)	CU NIPDAU	Level-1-260C-UNLIM	-40 to 125	BYI	Samples

(1) The marketing status values are defined as follows:

ACTIVE: Product device recommended for new designs.

LIFEBUY: TI has announced that the device will be discontinued, and a lifetime-buy period is in effect.

NRND: Not recommended for new designs. Device is in production to support existing customers, but TI does not recommend using this part in a new design.

PREVIEW: Device has been announced but is not in production. Samples may or may not be available.

OBSOLETE: TI has discontinued the production of the device.

(2) Eco Plan - The planned eco-friendly classification: Pb-Free (RoHS), Pb-Free (RoHS Exempt), or Green (RoHS & no Sb/Br) - please check <http://www.ti.com/productcontent> for the latest availability information and additional product content details.

TBD: The Pb-Free/Green conversion plan has not been defined.

Pb-Free (RoHS): TI's terms "Lead-Free" or "Pb-Free" mean semiconductor products that are compatible with the current RoHS requirements for all 6 substances, including the requirement that lead not exceed 0.1% by weight in homogeneous materials. Where designed to be soldered at high temperatures, TI Pb-Free products are suitable for use in specified lead-free processes.

Pb-Free (RoHS Exempt): This component has a RoHS exemption for either 1) lead-based flip-chip solder bumps used between the die and package, or 2) lead-based die adhesive used between the die and leadframe. The component is otherwise considered Pb-Free (RoHS compatible) as defined above.

Green (RoHS & no Sb/Br): TI defines "Green" to mean Pb-Free (RoHS compatible), and free of Bromine (Br) and Antimony (Sb) based flame retardants (Br or Sb do not exceed 0.1% by weight in homogeneous material)

(3) MSL, Peak Temp. -- The Moisture Sensitivity Level rating according to the JEDEC industry standard classifications, and peak solder temperature.

(4) Only one of markings shown within the brackets will appear on the physical device.

Important Information and Disclaimer: The information provided on this page represents TI's knowledge and belief as of the date that it is provided. TI bases its knowledge and belief on information provided by third parties, and makes no representation or warranty as to the accuracy of such information. Efforts are underway to better integrate information from third parties. TI has taken and continues to take reasonable steps to provide representative and accurate information but may not have conducted destructive testing or chemical analysis on incoming materials and chemicals. TI and TI suppliers consider certain information to be proprietary, and thus CAS numbers and other limited information may not be available for release.

In no event shall TI's liability arising out of such information exceed the total purchase price of the TI part(s) at issue in this document sold by TI to Customer on an annual basis.

TAPE AND REEL INFORMATION



QUADRANT ASSIGNMENTS FOR PIN 1 ORIENTATION IN TAPE



*All dimensions are nominal

Device	Package Type	Package Drawing	Pins	SPQ	Reel Diameter (mm)	Reel Width W1 (mm)	A0 (mm)	B0 (mm)	K0 (mm)	P1 (mm)	W (mm)	Pin1 Quadrant
TPD4E1B06DCKR	SC70	DCK	6	3000	178.0	9.0	2.4	2.5	1.2	4.0	8.0	Q3

TAPE AND REEL BOX DIMENSIONS



*All dimensions are nominal

Device	Package Type	Package Drawing	Pins	SPQ	Length (mm)	Width (mm)	Height (mm)
TPD4E1B06DCKR	SC70	DCK	6	3000	180.0	180.0	18.0

DCK (R-PDSO-G6)

PLASTIC SMALL-OUTLINE PACKAGE



- NOTES:
- A. All linear dimensions are in millimeters.
 - B. This drawing is subject to change without notice.
 - C. Body dimensions do not include mold flash or protrusion. Mold flash and protrusion shall not exceed 0.15 per side.
 - D. Falls within JEDEC MO-203 variation AB.

DCK (R-PDSO-G6)

PLASTIC SMALL OUTLINE



- NOTES:
- All linear dimensions are in millimeters.
 - This drawing is subject to change without notice.
 - Customers should place a note on the circuit board fabrication drawing not to alter the center solder mask defined pad.
 - Publication IPC-7351 is recommended for alternate designs.
 - Laser cutting apertures with trapezoidal walls and also rounding corners will offer better paste release. Customers should contact their board assembly site for stencil design recommendations. Example stencil design based on a 50% volumetric metal load solder paste. Refer to IPC-7525 for other stencil recommendations.

IMPORTANT NOTICE

Texas Instruments Incorporated and its subsidiaries (TI) reserve the right to make corrections, enhancements, improvements and other changes to its semiconductor products and services per JESD46, latest issue, and to discontinue any product or service per JESD48, latest issue. Buyers should obtain the latest relevant information before placing orders and should verify that such information is current and complete. All semiconductor products (also referred to herein as "components") are sold subject to TI's terms and conditions of sale supplied at the time of order acknowledgment.

TI warrants performance of its components to the specifications applicable at the time of sale, in accordance with the warranty in TI's terms and conditions of sale of semiconductor products. Testing and other quality control techniques are used to the extent TI deems necessary to support this warranty. Except where mandated by applicable law, testing of all parameters of each component is not necessarily performed.

TI assumes no liability for applications assistance or the design of Buyers' products. Buyers are responsible for their products and applications using TI components. To minimize the risks associated with Buyers' products and applications, Buyers should provide adequate design and operating safeguards.

TI does not warrant or represent that any license, either express or implied, is granted under any patent right, copyright, mask work right, or other intellectual property right relating to any combination, machine, or process in which TI components or services are used. Information published by TI regarding third-party products or services does not constitute a license to use such products or services or a warranty or endorsement thereof. Use of such information may require a license from a third party under the patents or other intellectual property of the third party, or a license from TI under the patents or other intellectual property of TI.

Reproduction of significant portions of TI information in TI data books or data sheets is permissible only if reproduction is without alteration and is accompanied by all associated warranties, conditions, limitations, and notices. TI is not responsible or liable for such altered documentation. Information of third parties may be subject to additional restrictions.

Resale of TI components or services with statements different from or beyond the parameters stated by TI for that component or service voids all express and any implied warranties for the associated TI component or service and is an unfair and deceptive business practice. TI is not responsible or liable for any such statements.

Buyer acknowledges and agrees that it is solely responsible for compliance with all legal, regulatory and safety-related requirements concerning its products, and any use of TI components in its applications, notwithstanding any applications-related information or support that may be provided by TI. Buyer represents and agrees that it has all the necessary expertise to create and implement safeguards which anticipate dangerous consequences of failures, monitor failures and their consequences, lessen the likelihood of failures that might cause harm and take appropriate remedial actions. Buyer will fully indemnify TI and its representatives against any damages arising out of the use of any TI components in safety-critical applications.

In some cases, TI components may be promoted specifically to facilitate safety-related applications. With such components, TI's goal is to help enable customers to design and create their own end-product solutions that meet applicable functional safety standards and requirements. Nonetheless, such components are subject to these terms.

No TI components are authorized for use in FDA Class III (or similar life-critical medical equipment) unless authorized officers of the parties have executed a special agreement specifically governing such use.

Only those TI components which TI has specifically designated as military grade or "enhanced plastic" are designed and intended for use in military/aerospace applications or environments. Buyer acknowledges and agrees that any military or aerospace use of TI components which have **not** been so designated is solely at the Buyer's risk, and that Buyer is solely responsible for compliance with all legal and regulatory requirements in connection with such use.

TI has specifically designated certain components as meeting ISO/TS16949 requirements, mainly for automotive use. In any case of use of non-designated products, TI will not be responsible for any failure to meet ISO/TS16949.

Products

Audio	www.ti.com/audio
Amplifiers	amplifier.ti.com
Data Converters	dataconverter.ti.com
DLP® Products	www.dlp.com
DSP	dsp.ti.com
Clocks and Timers	www.ti.com/clocks
Interface	interface.ti.com
Logic	logic.ti.com
Power Mgmt	power.ti.com
Microcontrollers	microcontroller.ti.com
RFID	www.ti-rfid.com
OMAP Applications Processors	www.ti.com/omap
Wireless Connectivity	www.ti.com/wirelessconnectivity

Applications

Automotive and Transportation	www.ti.com/automotive
Communications and Telecom	www.ti.com/communications
Computers and Peripherals	www.ti.com/computers
Consumer Electronics	www.ti.com/consumer-apps
Energy and Lighting	www.ti.com/energy
Industrial	www.ti.com/industrial
Medical	www.ti.com/medical
Security	www.ti.com/security
Space, Avionics and Defense	www.ti.com/space-avionics-defense
Video and Imaging	www.ti.com/video

TI E2E Community

e2e.ti.com