

LMV112 40 MHz Dual Clock Buffer

Check for Samples: [LMV112](#)

FEATURES

- (Typical Values are: $V_{\text{SUPPLY}} = 2.7\text{V}$ and $C_L = 20\text{ pF}$, Unless Otherwise Specified.)
- Small Signal Bandwidth 40 MHz
- Supply Voltage Range 2.4V to 5V
- Slew Rate 110 V/ μs
- Total Supply Current 1.6 mA
- Shutdown Current 59 μA
- Rail-to-Rail Input and Output
- Individual Buffer Enable Pins
- Rapid T_{on} Technology
- Crosstalk Rejection Circuitry
- 8-pin WSON, Pin Access Packaging
- Temperature Range -40°C to 85°C

APPLICATIONS

- 3G Mobile Applications
- WLAN-WiMAX Modules
- TD_SCDMA Multi-Mode MP3 and Camera
- GSM Modules
- Oscillator Modules

DESCRIPTION

The LMV112 is a high speed dual clock buffer designed for portable communications and accurate multi-clock systems. The LMV112 integrates two 40 MHz low noise buffers which optimizes application and out performs large discrete solutions. This device enables superb system operation between the base band and the oscillator signal path while eliminating crosstalk.

Texas Instruments' unique technology and design deliver accuracy, capacitance and load resistance while increasing the drive capability of the device. The low power consumption makes the LMV112 perfect for battery applications.

The robust, independent, and flexible buffers are designed to provide the customer with the ability to manage complex clock signals in the latest wireless applications. The buffers deliver 110 V/ μs internal slew rate with independent shutdown and duty cycle precision. The patented analog circuit drives capacitive loads beyond 20 pF. Texas Instruments' proven biasing technique has 1V centering, rail-to-rail input/output unity gain, and AC coupled convenient inputs. These integrated cells save space and require no external bias resistors. Texas Instruments' rapid recovery after disable optimizes performance and current consumption. The LMV112 offers individual enable pin controls and since there is no internal ground reference either single or split supply configurations offer additional system flexibility and power choices.

The LMV112 is a proven replacement for any discrete circuitry and simplifies board layout while minimizing related parasitic components.

The LMV112 is produced in the small WSON package which offers high quality while minimizing its use of PCB space. Texas Instruments' advanced packaging offers direct PCB-IC evaluation via pin access.



Please be aware that an important notice concerning availability, standard warranty, and use in critical applications of Texas Instruments semiconductor products and disclaimers thereto appears at the end of this data sheet.

All trademarks are the property of their respective owners.

TYPICAL APPLICATION

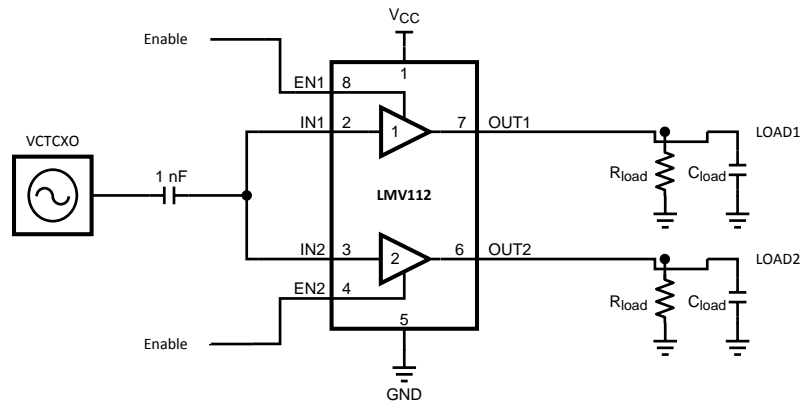

Figure 1.



These devices have limited built-in ESD protection. The leads should be shorted together or the device placed in conductive foam during storage or handling to prevent electrostatic damage to the MOS gates.

ABSOLUTE MAXIMUM RATINGS⁽¹⁾⁽²⁾

Supply Voltages (V ⁺ – V ⁻)	5.5V
ESD Tolerance ⁽³⁾	
Human Body	2000V
Machine Model	200V
Storage Temperature Range	-65°C to +150°C
Junction Temperature ⁽⁴⁾	+150°C
Soldering Information	
Infrared or Convection (35 sec.)	235°C

- (1) Absolute Maximum Ratings indicate limits beyond which damage to the device may occur. Operating Ratings indicate conditions for which the device is intended to be functional, but specific performance is not ensured. For specifications and the test conditions, see the Electrical Characteristics Tables.
- (2) If Military/Aerospace specified devices are required, please contact the Texas Instruments Sales Office/ Distributors for availability and specifications.
- (3) Human Body Model: 1.5 kΩ in series with 100 pF. Machine Model: 0Ω in series with 200 pF.
- (4) The maximum power dissipation is a function of T_{J(MAX)}, θ_{JA}, and T_A. The maximum allowable power dissipation at any ambient temperature is P_D = (T_{J(MAX)} - T_A) / θ_{JA}. All numbers apply for packages soldered directly onto a PC board.

OPERATING RATINGS⁽¹⁾

Supply Voltage (V ⁺ – V ⁻)	2.4V to 5.0V
Temperature Range ^{(2) (3)}	-40°C to +85°C
Package Thermal Resistance ^{(2) (3)}	
WSON-8 (θ _{JA})	217°C/W

- (1) Absolute Maximum Ratings indicate limits beyond which damage to the device may occur. Operating Ratings indicate conditions for which the device is intended to be functional, but specific performance is not ensured. For specifications and the test conditions, see the Electrical Characteristics Tables.
- (2) The maximum power dissipation is a function of T_{J(MAX)}, θ_{JA}, and T_A. The maximum allowable power dissipation at any ambient temperature is P_D = (T_{J(MAX)} - T_A) / θ_{JA}. All numbers apply for packages soldered directly onto a PC board.
- (3) Electrical Table values apply only for factory testing conditions at the temperature indicated. Factory testing conditions result in very limited self-heating of the device such that T_J = T_A.

2.7V ELECTRICAL CHARACTERISTICS

Unless otherwise specified, all limits are specified for $T_J = 25^\circ\text{C}$, $V_{DD} = 2.7\text{V}$, $V_{SS} = 0\text{V}$, $V_{CM} = 1\text{V}$, $\text{Enable}_{1,2} = V_{DD}$, $C_L = 20\text{ pF}$, $R_L = 30\text{ k}\Omega$, $C_{COUPLING} = 1\text{ nF}$. **Boldface** limits apply at temperature range extremes of operating condition. See ⁽¹⁾.

Symbol	Parameter	Conditions	Min ⁽²⁾	Typ ⁽³⁾	Max ⁽²⁾	Units
Frequency Domain Response						
SSBW	Small Signal Bandwidth	$V_{IN} = 0.63 V_{PP}$; -3 dB		40		MHz
FPBW	Full Power Bandwidth	$V_{IN} = 1.6 V_{PP}$; -3 dB		28		MHz
GFN	Gain Flatness < 0.1 dB	$f > 100\text{ kHz}$		3.4		MHz
Distortion and Noise Performance						
e_n	Input-Referred Voltage Noise	$f = 1\text{ MHz}$		26		nV/ $\sqrt{\text{Hz}}$
$I_{\text{ISOLATION}}$	Output to Input	$f = 1\text{ MHz}$		91		dB
CT	Crosstalk Rejection	$f = 26\text{ MHz}$, $P_{IN} = 0\text{ dBm}$		54		dB
Time Domain Response						
t_r	Rise Time	0.1 V_{PP} Step (10-90%), $f = 1\text{ MHz}$		7		ns
t_f	Fall Time			6		ns
t_s	Settling Time to 0.1%	1 V_{PP} Step, $f = 1\text{ MHz}$		118		ns
OS	Overshoot	0.1 V_{PP} Step, $f = 1\text{ MHz}$		41		%
SR	Slew Rate ⁽⁴⁾	$V_{IN} = 1.6 V_{PP}$, $f = 26\text{ MHz}$		110		V/ μs
Static DC Performance						
I_S	Supply Current	$\text{Enable}_{1,2} = V_{DD}$; No Load		1.6	2.0 2.1	mA
		$\text{Enable}_{1,2} = V_{SS}$; No Load		59	72 78	μA
PSRR	Power Supply Rejection Ratio	DC (3.0V to 5.0V)	58 57	68		dB
A_{CL}	Small Signal Voltage Gain	$V_{OUT} = 0.1 V_{PP}$	0.97 0.95	1.01	1.05 1.07	V/V
V_{OS}	Output Offset Voltage			0.4	16 17	mV
TC V_{OS}	Temperature Coefficient Output Offset Voltage ⁽⁵⁾			4		$\mu\text{V}/^\circ\text{C}$
R_{OUT}	Output Resistance	$f = 100\text{ kHz}$		0.5		Ω
		$f = 26\text{ MHz}$		140		
Miscellaneous Performance						
R_{IN}	Input Resistance per Buffer	$\text{Enable} = V_{DD}$		141		k Ω
		$\text{Enable} = V_{SS}$		141		
C_{IN}	Input Capacitance per Buffer	$\text{Enable} = V_{DD}$		2.3		pF
		$\text{Enable} = V_{SS}$		2.3		
Z_{IN}	Input Impedance	$f = 26\text{ MHz}$, $\text{Enable} = V_{DD}$		10.4		k Ω
		$f = 26\text{ MHz}$, $\text{Enable} = V_{SS}$		10.9		
V_O	Output Swing Positive	$V_{IN} = V_{DD}$	2.65 2.63	2.69		V
	Output Swing Negative	$V_{IN} = V_{SS}$		10	50 65	mV

- (1) Electrical Table values apply only for factory testing conditions at the temperature indicated. Factory testing conditions result in very limited self-heating of the device such that $T_J = T_A$.
- (2) All limits are specified by testing or statistical analysis.
- (3) Typical Values represent the most likely parametric norm.
- (4) Slew rate is the average of the positive and negative slew rate.
- (5) Average Temperature Coefficient is determined by dividing the changing in a parameter at temperature extremes by the total temperature change.

2.7V ELECTRICAL CHARACTERISTICS (continued)

Unless otherwise specified, all limits are specified for $T_J = 25^\circ\text{C}$, $V_{DD} = 2.7\text{V}$, $V_{SS} = 0\text{V}$, $V_{CM} = 1\text{V}$, $\text{Enable}_{1,2} = V_{DD}$, $C_L = 20\text{ pF}$, $R_L = 30\text{ k}\Omega$, $C_{COUPLING} = 1\text{ nF}$. **Boldface** limits apply at temperature range extremes of operating condition. See ⁽¹⁾.

Symbol	Parameter	Conditions	Min ⁽²⁾	Typ ⁽³⁾	Max ⁽²⁾	Units
I_{SC}	Output Short-Circuit Current ⁽⁶⁾	Sourcing	-18 -13	-27		mA
		Sinking	20 16	30		
V_{en_hmin}	Enable High Active Minimum Voltage			1.2		V
V_{en_lmax}	Enable Low Inactive Maximum Voltage			0.6		

(6) Short-Circuit test is a momentary test. Continuous short circuit operation at elevated ambient temperature can result in exceeding the maximum allowed junction temperature of 150°C .

5V ELECTRICAL CHARACTERISTICS

Unless otherwise specified, all limits are specified for $T_J = 25^\circ\text{C}$, $V_{DD} = 5\text{V}$, $V_{SS} = 0\text{V}$, $V_{CM} = 1\text{V}$, $\text{Enable}_{1,2} = V_{DD}$, $C_L = 20\text{ pF}$, $R_L = 30\text{ k}\Omega$, $C_{COUPLING} = 1\text{ nF}$. **Boldface** limits apply at temperature range extremes of operating condition. See ⁽¹⁾.

Symbol	Parameter	Conditions	Min ⁽²⁾	Typ ⁽³⁾	Max ⁽²⁾	Units
Frequency Domain Response						
SSBW	Small Signal Bandwidth	$V_{IN} = 0.63 V_{PP}$; -3 dB		42		MHz
FPBW	Full Power Bandwidth	$V_{IN} = 1.6 V_{PP}$; -3 dB		31		MHz
GFN	Gain Flatness < 0.1 dB	$f > 100\text{ kHz}$		4.9		MHz
Distortion and Noise Performance						
e_n	Input-Referred Voltage Noise	$f = 1\text{ MHz}$		27		$\text{nV}/\sqrt{\text{Hz}}$
$I_{SOLATION}$	Output to Input	$f = 1\text{ MHz}$		90		dB
CT	Crosstalk Rejection	$f = 26\text{ MHz}$, $P_{IN} = 0\text{ dBm}$		61		dB
Time Domain Response						
t_r	Rise Time	0.1 V_{PP} Step (10-90%), $f = 1\text{ MHz}$		7		ns
t_f	Fall Time			6		ns
t_s	Settling Time to 0.1%	1 V_{PP} Step, $f = 1\text{ MHz}$		80		ns
OS	Overshoot	0.1 V_{PP} Step, $f = 1\text{ MHz}$		20		%
SR	Slew Rate ⁽⁴⁾	$V_{IN} = 1.6 V_{PP}$, $f = 26\text{ MHz}$		120		$\text{V}/\mu\text{s}$
Static DC Performance						
I_S	Supply Current	$\text{Enable}_{1,2} = V_{DD}$; No Load		2.5	3.5 3.8	mA
		$\text{Enable}_{1,2} = V_{SS}$; No Load		62	80 89	
PSRR	Power Supply Rejection Ratio	DC (3.0V to 5.0V)	58 57	68		dB
A_{CL}	Small Signal Voltage Gain	$V_{OUT} = 0.1 V_{PP}$	0.99 0.97	1.00	1.01 1.03	V/V
V_{OS}	Output Offset Voltage			1.3	16 17	mV
TC V_{OS}	Temperature Coefficient Output Offset Voltage ⁽⁵⁾			3		$\mu\text{V}/^\circ\text{C}$
R_{OUT}	Output Resistance	$f = 100\text{ kHz}$		0.5		Ω
		$f = 26\text{ MHz}$		118		

- (1) Electrical Table values apply only for factory testing conditions at the temperature indicated. Factory testing conditions result in very limited self-heating of the device such that $T_J = T_A$.
- (2) All limits are specified by testing or statistical analysis.
- (3) Typical Values represent the most likely parametric norm.
- (4) Slew rate is the average of the positive and negative slew rate.
- (5) Average Temperature Coefficient is determined by dividing the changing in a parameter at temperature extremes by the total temperature change.

5V ELECTRICAL CHARACTERISTICS (continued)

Unless otherwise specified, all limits are specified for $T_J = 25^\circ\text{C}$, $V_{DD} = 5\text{V}$, $V_{SS} = 0\text{V}$, $V_{CM} = 1\text{V}$, $\text{Enable}_{1,2} = V_{DD}$, $C_L = 20\text{pF}$, $R_L = 30\text{k}\Omega$, $C_{COUPLING} = 1\text{nF}$. **Boldface** limits apply at temperature range extremes of operating condition. See ⁽¹⁾.

Symbol	Parameter	Conditions	Min ⁽²⁾	Typ ⁽³⁾	Max ⁽²⁾	Units
Miscellaneous Performance						
R_{IN}	Input Resistance per Buffer	Enable = V_{DD}		134		k Ω
		Enable = V_{SS}		134		
C_{IN}	Input Capacitance per Buffer	Enable = V_{DD}		2.0		pF
		Enable = V_{SS}		2.0		
Z_{IN}	Input Impedance	$f = 26\text{MHz}$, Enable = V_{DD}		7.2		k Ω
		$f = 26\text{MHz}$, Enable = V_{SS}		8.0		
V_O	Output Swing Positive	$V_{IN} = V_{DD}$	4.96 4.94	4.99		V
	Output Swing Negative	$V_{IN} = V_{SS}$		10	40 55	mV
I_{SC}	Output Short-Circuit Current ⁽⁶⁾	Sourcing	-40 -28	-68		mA
		Sinking	70 50	98		
V_{en_hmin}	Enable High Active Minimum Voltage			1.2		V
V_{en_lmax}	Enable Low Inactive Maximum Voltage			0.6		

(6) Short-Circuit test is a momentary test. Continuous short circuit operation at elevated ambient temperature can result in exceeding the maximum allowed junction temperature of 150°C .

BLOCK DIAGRAM

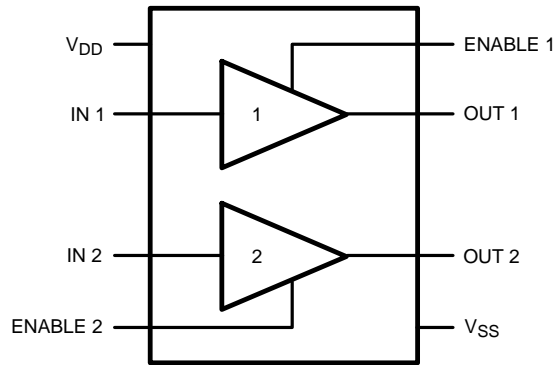

Figure 2.

PIN DESCRIPTIONS

Pin No.	Pin Name	Description
1	V _{DD}	Voltage supply connection
2	IN 1	Input 1
3	IN 2	Input 2
4	ENABLE 2	Enable buffer 2
5	V _{SS}	Ground connection
6	OUT 2	Output 2
7	OUT 1	Output 1
8	ENABLE 1	Enable buffer 1

CONNECTION DIAGRAM

Top View

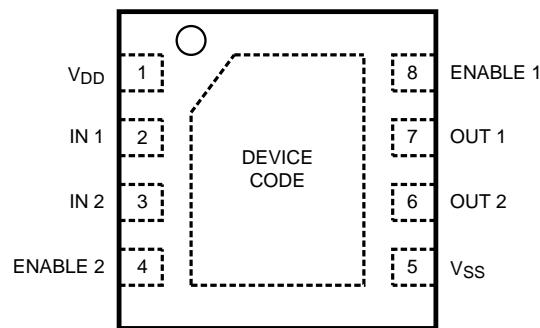

Figure 3. 8-Pin WSON (NGQ Package)

TYPICAL PERFORMANCE CHARACTERISTICS

$T_J = 25^\circ\text{C}$, $V_{DD} = 2.7\text{V}$, $V_{SS} = 0\text{V}$, $\text{Enable}_{1,2} = V_{DD}$, $C_L = 20\text{ pF}$, $R_L = 30\text{ k}\Omega$ and $C_{\text{COUPLING}} = 1\text{ nF}$, unless otherwise specified.

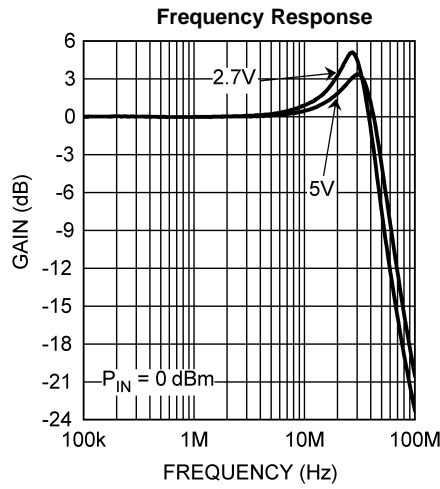

Figure 4.

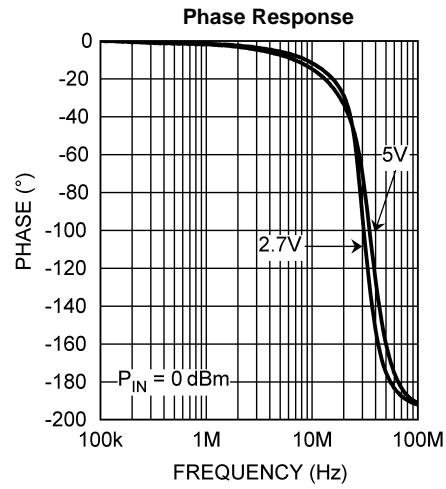

Figure 5.

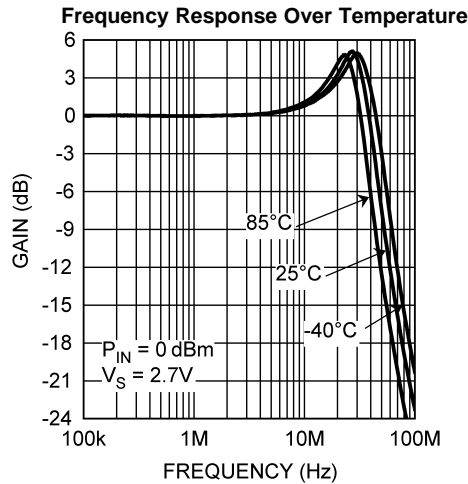

Figure 6.

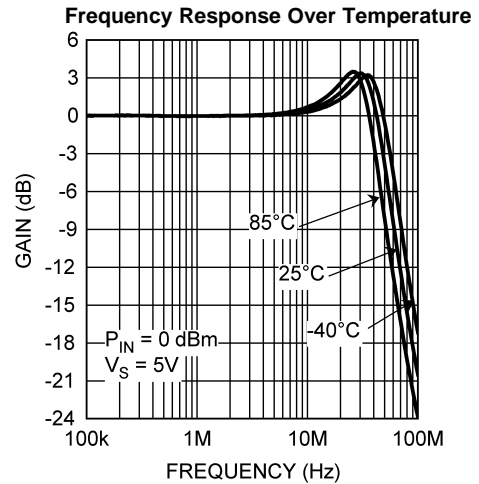

Figure 7.

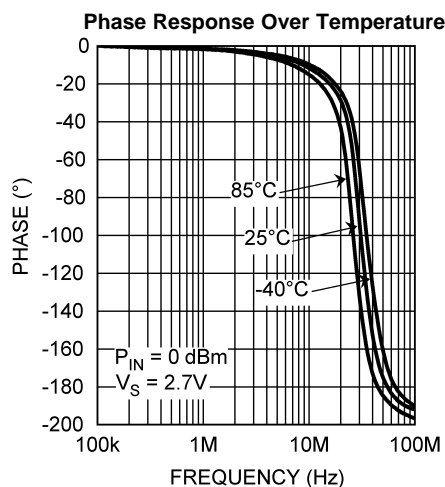

Figure 8.

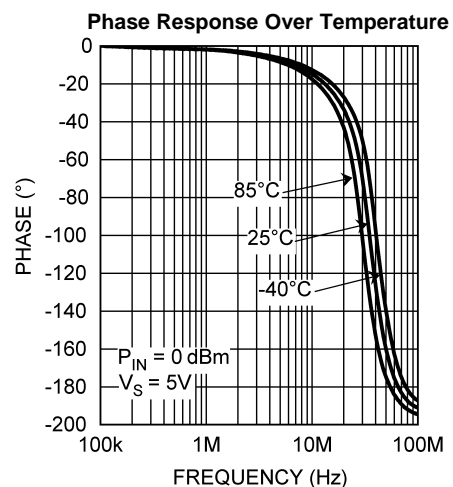

Figure 9.

TYPICAL PERFORMANCE CHARACTERISTICS (continued)

$T_J = 25^\circ\text{C}$, $V_{DD} = 2.7\text{V}$, $V_{SS} = 0\text{V}$, $\text{Enable}_{1,2} = V_{DD}$, $C_L = 20\text{ pF}$, $R_L = 30\text{ k}\Omega$ and $C_{\text{COUPLING}} = 1\text{ nF}$, unless otherwise specified.

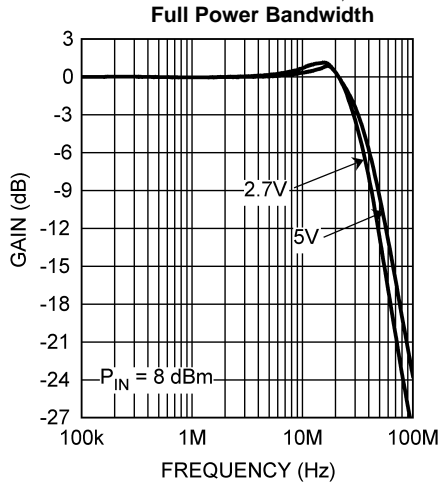

Figure 10.

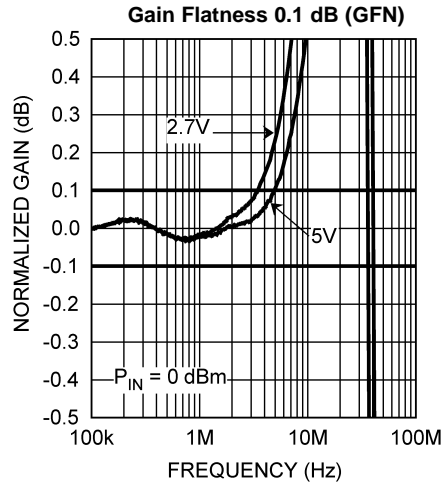

Figure 11.

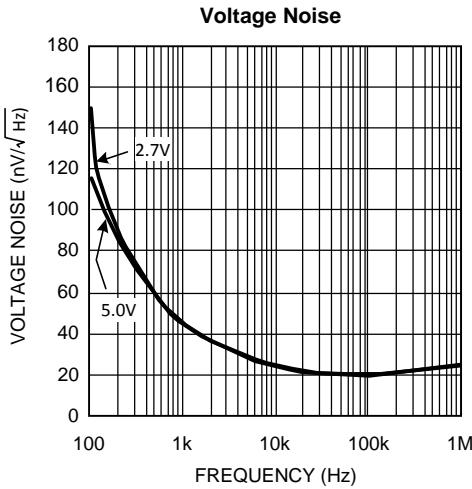

Figure 12.

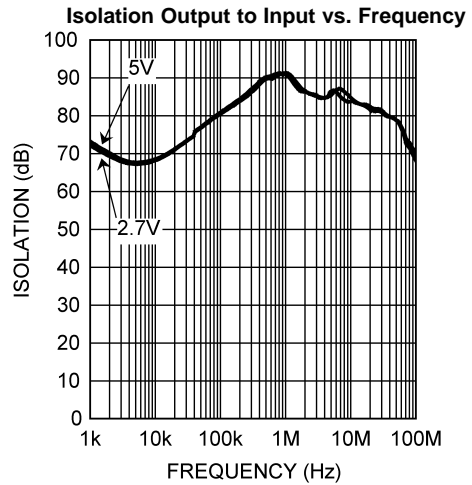

Figure 13.

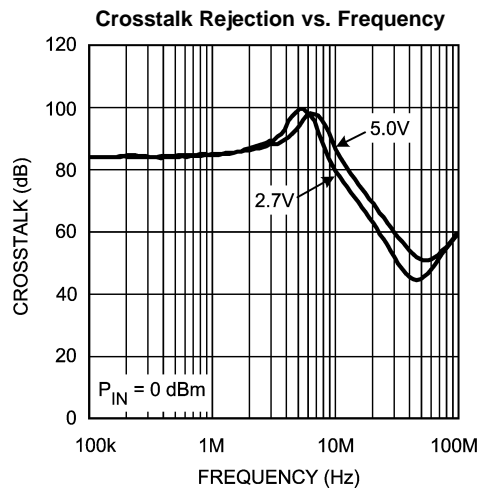

Figure 14.

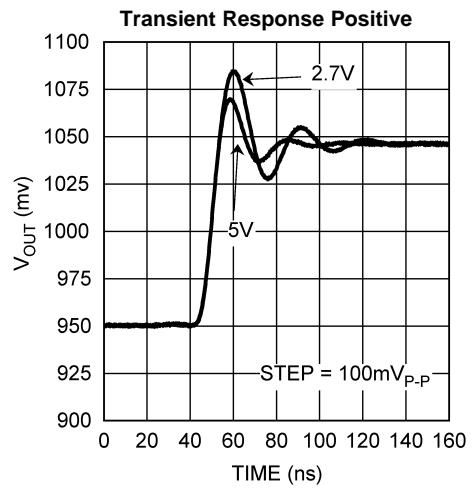

Figure 15.

TYPICAL PERFORMANCE CHARACTERISTICS (continued)

$T_J = 25^\circ\text{C}$, $V_{DD} = 2.7\text{V}$, $V_{SS} = 0\text{V}$, $\text{Enable}_{1,2} = V_{DD}$, $C_L = 20\text{ pF}$, $R_L = 30\text{ k}\Omega$ and $C_{\text{COUPLING}} = 1\text{ nF}$, unless otherwise specified.

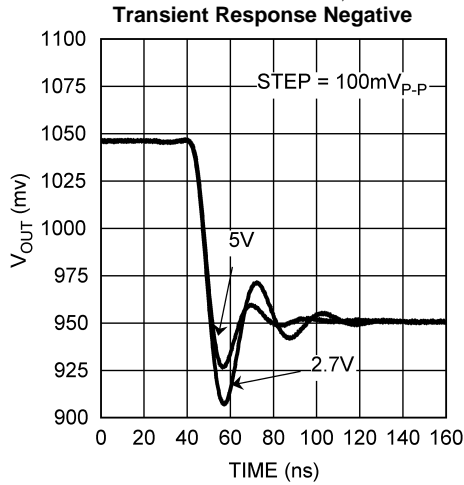

Figure 16.

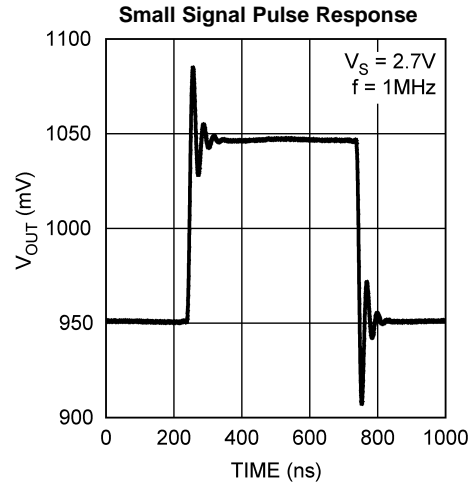

Figure 17.

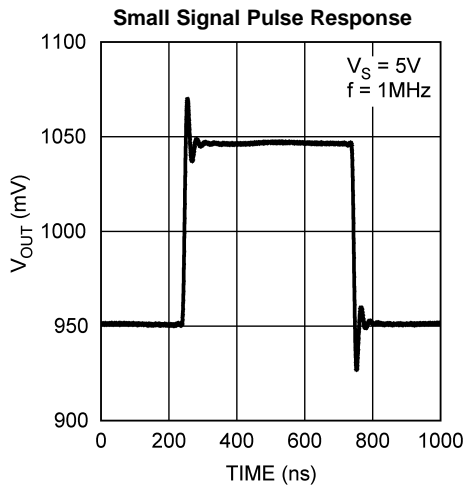

Figure 18.

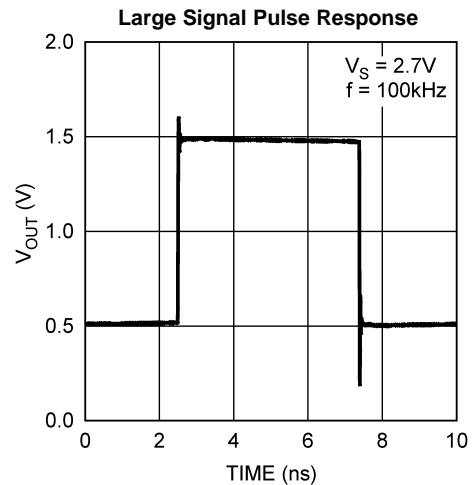

Figure 19.

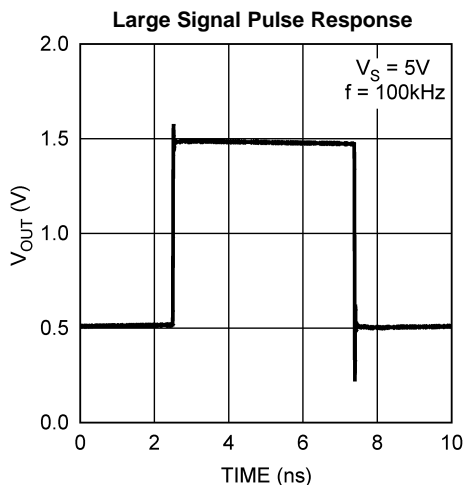

Figure 20.

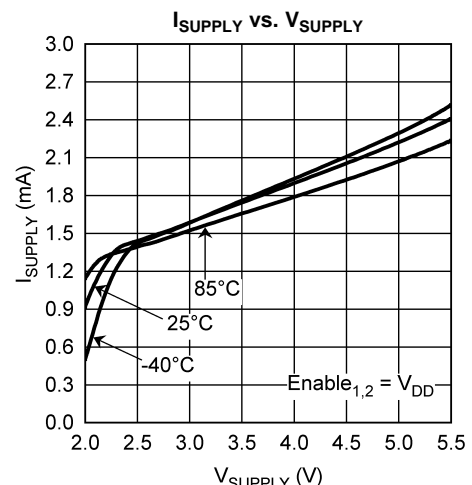
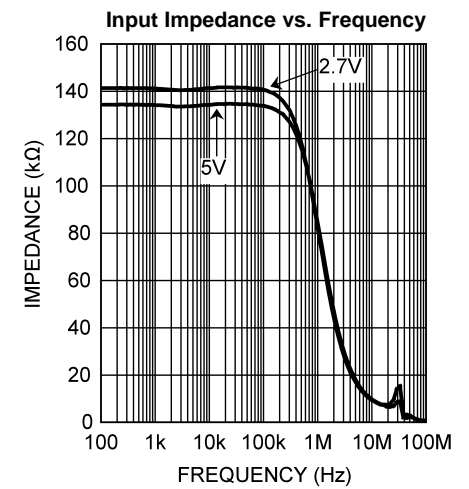
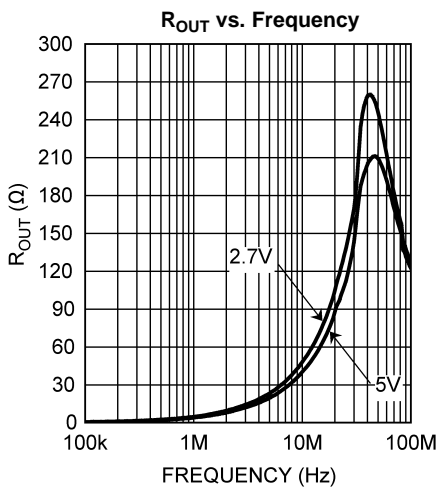
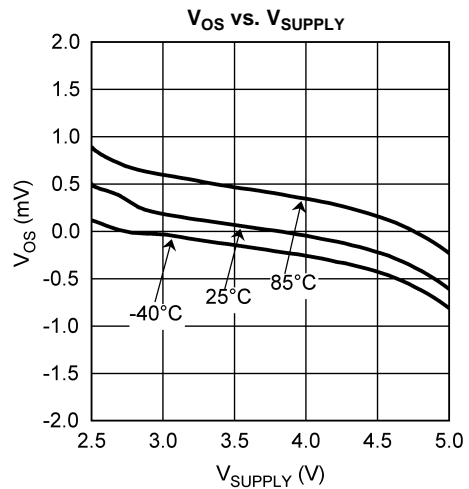
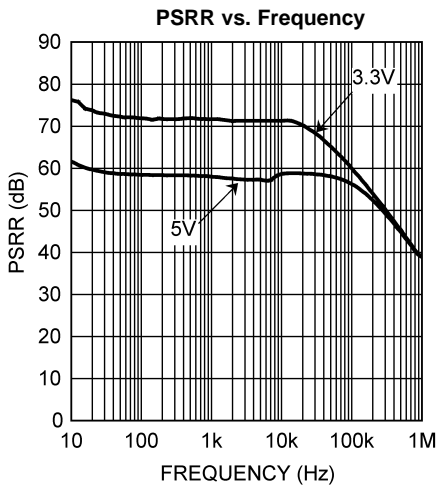
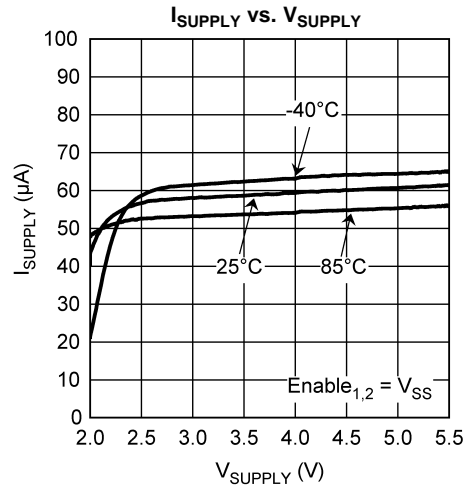
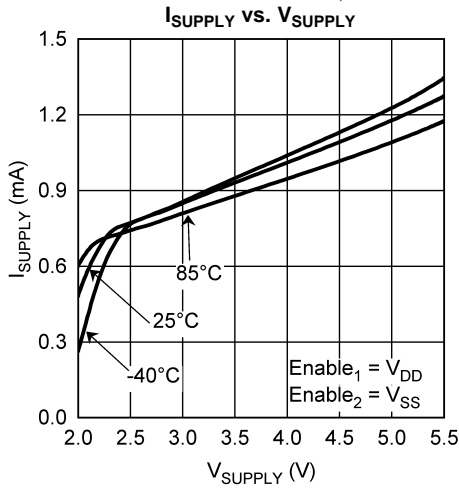

Figure 21.

TYPICAL PERFORMANCE CHARACTERISTICS (continued)

$T_J = 25^\circ\text{C}$, $V_{DD} = 2.7\text{V}$, $V_{SS} = 0\text{V}$, $\text{Enable}_{1,2} = V_{DD}$, $C_L = 20\text{ pF}$, $R_L = 30\text{ k}\Omega$ and $C_{\text{COUPLING}} = 1\text{ nF}$, unless otherwise specified.



TYPICAL PERFORMANCE CHARACTERISTICS (continued)

$T_J = 25^\circ\text{C}$, $V_{DD} = 2.7\text{V}$, $V_{SS} = 0\text{V}$, $\text{Enable}_{1,2} = V_{DD}$, $C_L = 20\text{ pF}$, $R_L = 30\text{ k}\Omega$ and $C_{\text{COUPLING}} = 1\text{ nF}$, unless otherwise specified.

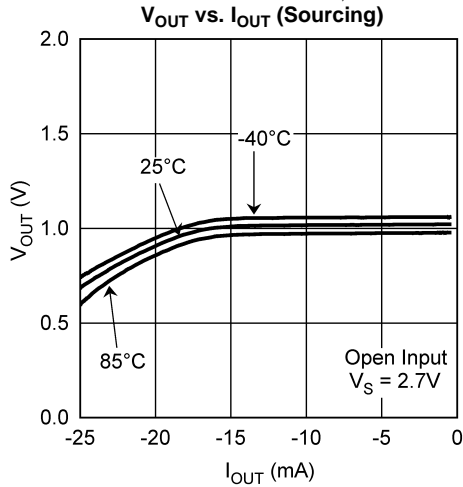

Figure 28.

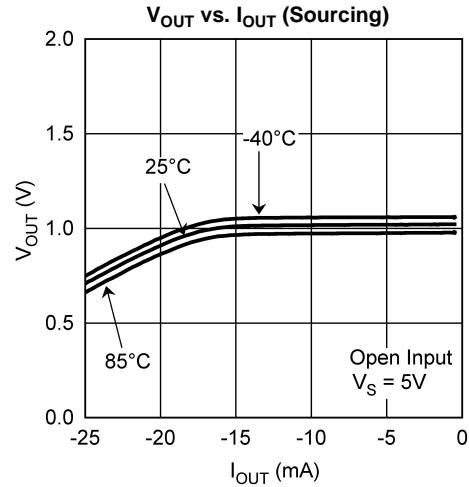

Figure 29.

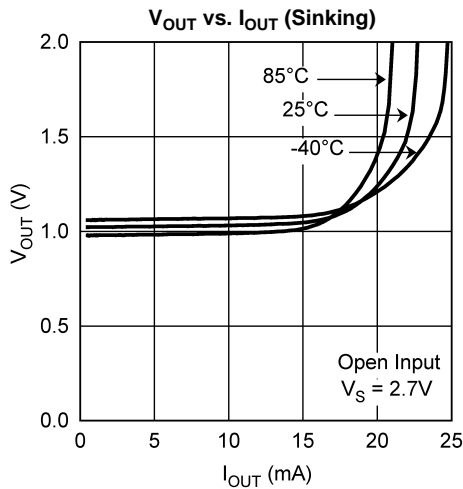

Figure 30.

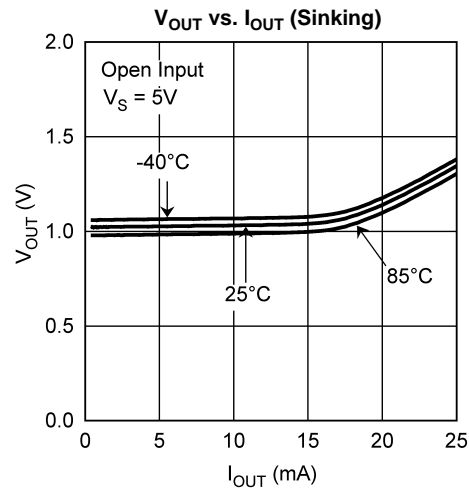

Figure 31.

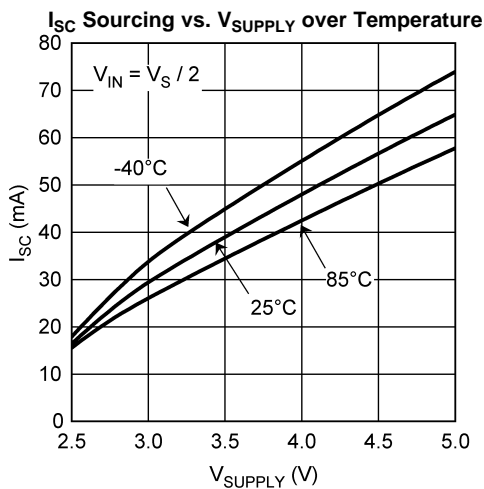

Figure 32.

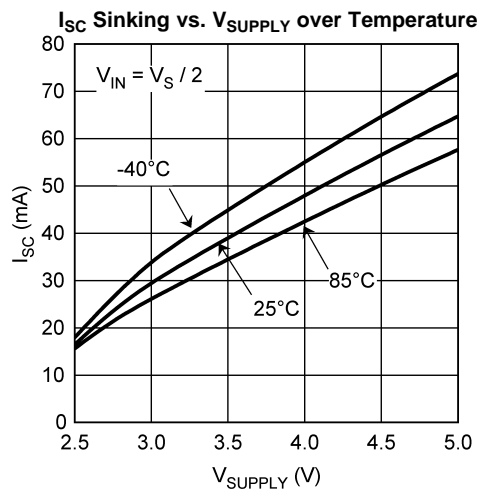

Figure 33.

TYPICAL PERFORMANCE CHARACTERISTICS (continued)

$T_J = 25^\circ\text{C}$, $V_{DD} = 2.7\text{V}$, $V_{SS} = 0\text{V}$, $\text{Enable}_{1,2} = V_{DD}$, $C_L = 20\text{ pF}$, $R_L = 30\text{ k}\Omega$ and $C_{\text{COUPLING}} = 1\text{ nF}$, unless otherwise specified.

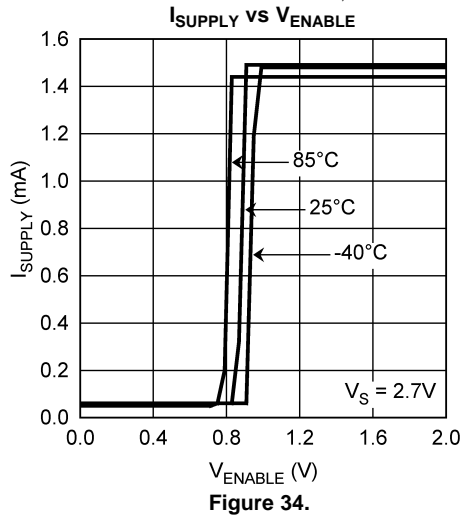

Figure 34.

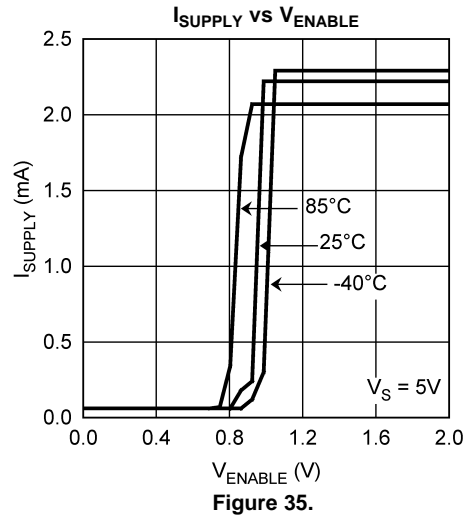

Figure 35.

APPLICATION INFORMATION

GENERAL

The LMV112 is designed to minimize the effects of spurious signals from the base band chip to the oscillator. Also the influence of varying load resistance and capacitance to the oscillator is minimized, while the drive capability is increased.

The inputs of the LMV112 are internally biased at 1V, making AC coupling possible without external bias resistors.

To optimize current consumption, the buffer not in use can be disabled by connecting the enable pin to V_{SS} .

The LMV112 has no internal ground reference; therefore, either single or split supply configurations can be used.

The LMV112 is an easy replacement for discrete circuitry. It simplifies board layout and minimizes the effect of layout related parasitic components.

INPUT CONFIGURATION

AC coupling is made possible by biasing the input. A large DC load at the oscillator input could change the load impedance and therefore it's oscillating frequency. To avoid external resistors the inputs are internally biased. This biasing is set at 1V as depicted in [Figure 36](#). Because this biasing is set at 1V, the maximum amplitude of the AC signal is $2 V_{PP}$.

The coupling capacitance should be large enough to let the AC signal pass. This is a unity gain buffer with rail-to-rail inputs and outputs.

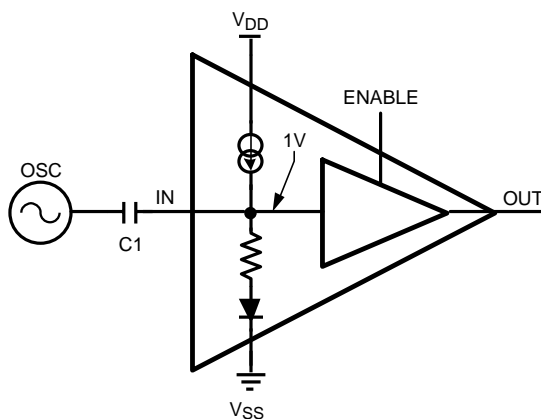

Figure 36. Input Configuration

FREQUENCY PULLING

Frequency pulling is the frequency variation of an oscillator caused by a varying load. In the typical application, the load of the oscillator is a fixed capacitor ($C1$) and the input impedance of the buffer.

To keep the input impedance as constant as possible, the input is biased at 1V, even when the part is disabled. A simplified schematic of the input configuration is shown in [Figure 36](#).

ISOLATION AND CROSSTALK

Output to input isolation prevents the clock from being affected by spurious signals generated by the digital blocks at the output buffer. See the characteristic graphic entitled “Isolation Output to Input vs. Frequency” in the [TYPICAL PERFORMANCE CHARACTERISTICS](#) section.

A block diagram of the isolation is shown in [Figure 37](#). Crosstalk rejection between buffers prevents signals from affecting each other. [Figure 37](#) shows a Base band IC and a Bluetooth module as examples of this. For more information, see the characteristic graphic labeled “Crosstalk Rejection vs. Frequency” in the [TYPICAL PERFORMANCE CHARACTERISTICS](#) section.

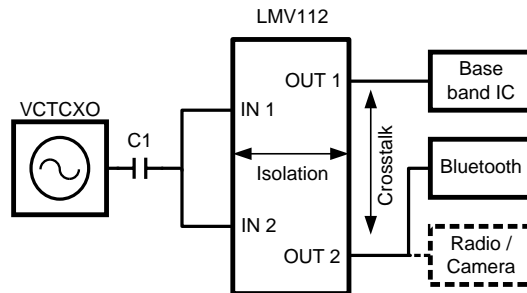

Figure 37. Isolation Block Diagram

DRIVING CAPACITIVE LOADS

Each buffer can drive a capacitive load. Be aware that every capacitor directly connected to the output becomes part of the loop of the buffer. In most applications the load consists of the capacitance of copper tracks and the input capacitance of the application blocks. Capacitance reduces the gain/phase margin and increases the instability. It leads to peaking in the frequency response and in extreme situations oscillations can occur. To drive a large capacitive load it is recommended that a series resistor is included between the buffer and the load capacitor. The best value for this isolation resistance is often found by experimentation.

The LMV112 datasheet reflects measurements with capacitance loads of 20 pF at the output of the buffers. Most common applications will probably use a lower capacitance load, which will result in lower peaking and significantly greater bandwidth, see [Figure 38](#).

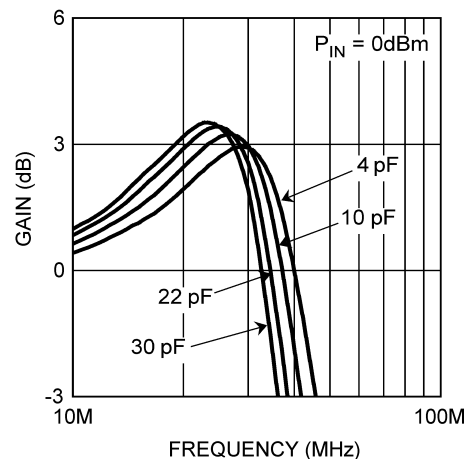

Figure 38. Bandwidth and Peaking

LAYOUT DESIGN RECOMMENDATION

Careful consideration for circuitry design and PCB layout will eliminate problems and will optimize the performance of the LMV112. It is best to have the same ground plane on the PCB for all power supply lines. This gives a low impedance return path for all decoupling and other ground connections.

To ensure a clean supply voltage it is best to place decoupling capacitors close to the LMV112, between V_{CC} and ground. The output of the VCO must be correctly terminated with proper load impedance.

Another important issue is the value of the components, which also determines the sensitivity to disturbances. Resistor values should be but avoid using values that cause a significant increase in power consumption while loading inputs or outputs to heavily.

REVISION HISTORY

Changes from Revision A (May 2013) to Revision B	Page
• Changed layout of National Data Sheet to TI format	15

PACKAGING INFORMATION

Orderable Device	Status (1)	Package Type	Package Drawing	Pins	Package Qty	Eco Plan (2)	Lead/Ball Finish	MSL Peak Temp (3)	Op Temp (°C)	Top-Side Markings (4)	Samples
LMV112SD	ACTIVE	WSON	NGQ	8	1000	TBD	Call TI	Call TI	-40 to 85	112SD	Samples
LMV112SD/NOPB	ACTIVE	WSON	NGQ	8	1000	Green (RoHS & no Sb/Br)	CU SN	Level-1-260C-UNLIM	-40 to 85	112SD	Samples
LMV112SDX	ACTIVE	WSON	NGQ	8	4500	TBD	Call TI	Call TI	-40 to 85	112SD	Samples
LMV112SDX/NOPB	ACTIVE	WSON	NGQ	8	4500	Green (RoHS & no Sb/Br)	CU SN	Level-1-260C-UNLIM	-40 to 85	112SD	Samples

(1) The marketing status values are defined as follows:

ACTIVE: Product device recommended for new designs.

LIFEBUY: TI has announced that the device will be discontinued, and a lifetime-buy period is in effect.

NRND: Not recommended for new designs. Device is in production to support existing customers, but TI does not recommend using this part in a new design.

PREVIEW: Device has been announced but is not in production. Samples may or may not be available.

OBSOLETE: TI has discontinued the production of the device.

(2) Eco Plan - The planned eco-friendly classification: Pb-Free (RoHS), Pb-Free (RoHS Exempt), or Green (RoHS & no Sb/Br) - please check <http://www.ti.com/productcontent> for the latest availability information and additional product content details.

TBD: The Pb-Free/Green conversion plan has not been defined.

Pb-Free (RoHS): TI's terms "Lead-Free" or "Pb-Free" mean semiconductor products that are compatible with the current RoHS requirements for all 6 substances, including the requirement that lead not exceed 0.1% by weight in homogeneous materials. Where designed to be soldered at high temperatures, TI Pb-Free products are suitable for use in specified lead-free processes.

Pb-Free (RoHS Exempt): This component has a RoHS exemption for either 1) lead-based flip-chip solder bumps used between the die and package, or 2) lead-based die adhesive used between the die and leadframe. The component is otherwise considered Pb-Free (RoHS compatible) as defined above.

Green (RoHS & no Sb/Br): TI defines "Green" to mean Pb-Free (RoHS compatible), and free of Bromine (Br) and Antimony (Sb) based flame retardants (Br or Sb do not exceed 0.1% by weight in homogeneous material)

(3) MSL, Peak Temp. -- The Moisture Sensitivity Level rating according to the JEDEC industry standard classifications, and peak solder temperature.

(4) Multiple Top-Side Markings will be inside parentheses. Only one Top-Side Marking contained in parentheses and separated by a "~" will appear on a device. If a line is indented then it is a continuation of the previous line and the two combined represent the entire Top-Side Marking for that device.

Important Information and Disclaimer: The information provided on this page represents TI's knowledge and belief as of the date that it is provided. TI bases its knowledge and belief on information provided by third parties, and makes no representation or warranty as to the accuracy of such information. Efforts are underway to better integrate information from third parties. TI has taken and continues to take reasonable steps to provide representative and accurate information but may not have conducted destructive testing or chemical analysis on incoming materials and chemicals. TI and TI suppliers consider certain information to be proprietary, and thus CAS numbers and other limited information may not be available for release.

In no event shall TI's liability arising out of such information exceed the total purchase price of the TI part(s) at issue in this document sold by TI to Customer on an annual basis.

TAPE AND REEL INFORMATION

QUADRANT ASSIGNMENTS FOR PIN 1 ORIENTATION IN TAPE

*All dimensions are nominal

Device	Package Type	Package Drawing	Pins	SPQ	Reel Diameter (mm)	Reel Width W1 (mm)	A0 (mm)	B0 (mm)	K0 (mm)	P1 (mm)	W (mm)	Pin1 Quadrant
LMV112SD	WSON	NGQ	8	1000	178.0	12.4	3.3	3.3	1.0	8.0	12.0	Q1
LMV112SD/NOPB	WSON	NGQ	8	1000	178.0	12.4	3.3	3.3	1.0	8.0	12.0	Q1
LMV112SDX	WSON	NGQ	8	4500	330.0	12.4	3.3	3.3	1.0	8.0	12.0	Q1
LMV112SDX/NOPB	WSON	NGQ	8	4500	330.0	12.4	3.3	3.3	1.0	8.0	12.0	Q1

TAPE AND REEL BOX DIMENSIONS

*All dimensions are nominal

Device	Package Type	Package Drawing	Pins	SPQ	Length (mm)	Width (mm)	Height (mm)
LMV112SD	WSON	NGQ	8	1000	210.0	185.0	35.0
LMV112SD/NOPB	WSON	NGQ	8	1000	210.0	185.0	35.0
LMV112SDX	WSON	NGQ	8	4500	367.0	367.0	35.0
LMV112SDX/NOPB	WSON	NGQ	8	4500	367.0	367.0	35.0

NGQ0008A

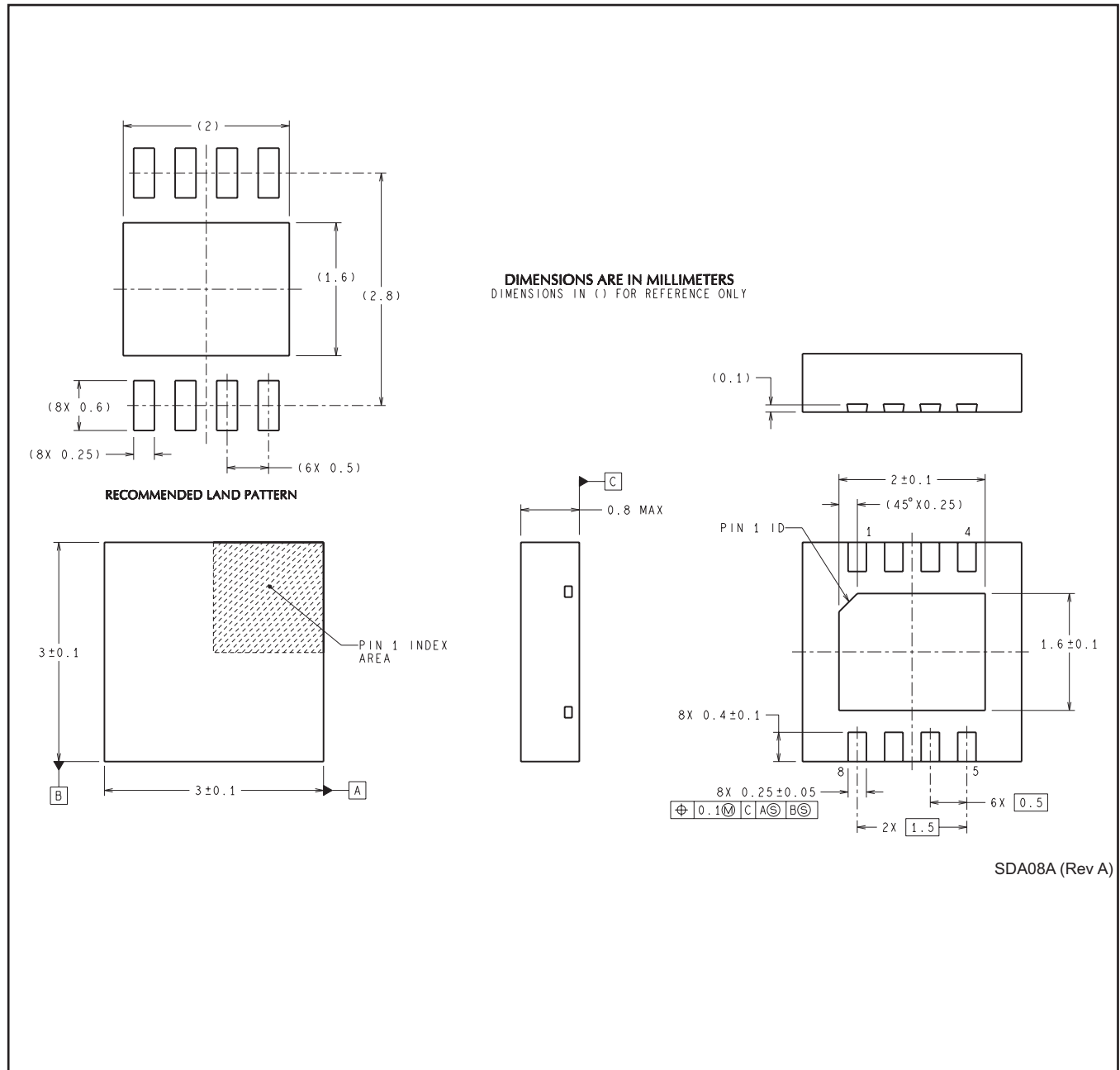

IMPORTANT NOTICE

Texas Instruments Incorporated and its subsidiaries (TI) reserve the right to make corrections, enhancements, improvements and other changes to its semiconductor products and services per JESD46, latest issue, and to discontinue any product or service per JESD48, latest issue. Buyers should obtain the latest relevant information before placing orders and should verify that such information is current and complete. All semiconductor products (also referred to herein as "components") are sold subject to TI's terms and conditions of sale supplied at the time of order acknowledgment.

TI warrants performance of its components to the specifications applicable at the time of sale, in accordance with the warranty in TI's terms and conditions of sale of semiconductor products. Testing and other quality control techniques are used to the extent TI deems necessary to support this warranty. Except where mandated by applicable law, testing of all parameters of each component is not necessarily performed.

TI assumes no liability for applications assistance or the design of Buyers' products. Buyers are responsible for their products and applications using TI components. To minimize the risks associated with Buyers' products and applications, Buyers should provide adequate design and operating safeguards.

TI does not warrant or represent that any license, either express or implied, is granted under any patent right, copyright, mask work right, or other intellectual property right relating to any combination, machine, or process in which TI components or services are used. Information published by TI regarding third-party products or services does not constitute a license to use such products or services or a warranty or endorsement thereof. Use of such information may require a license from a third party under the patents or other intellectual property of the third party, or a license from TI under the patents or other intellectual property of TI.

Reproduction of significant portions of TI information in TI data books or data sheets is permissible only if reproduction is without alteration and is accompanied by all associated warranties, conditions, limitations, and notices. TI is not responsible or liable for such altered documentation. Information of third parties may be subject to additional restrictions.

Resale of TI components or services with statements different from or beyond the parameters stated by TI for that component or service voids all express and any implied warranties for the associated TI component or service and is an unfair and deceptive business practice. TI is not responsible or liable for any such statements.

Buyer acknowledges and agrees that it is solely responsible for compliance with all legal, regulatory and safety-related requirements concerning its products, and any use of TI components in its applications, notwithstanding any applications-related information or support that may be provided by TI. Buyer represents and agrees that it has all the necessary expertise to create and implement safeguards which anticipate dangerous consequences of failures, monitor failures and their consequences, lessen the likelihood of failures that might cause harm and take appropriate remedial actions. Buyer will fully indemnify TI and its representatives against any damages arising out of the use of any TI components in safety-critical applications.

In some cases, TI components may be promoted specifically to facilitate safety-related applications. With such components, TI's goal is to help enable customers to design and create their own end-product solutions that meet applicable functional safety standards and requirements. Nonetheless, such components are subject to these terms.

No TI components are authorized for use in FDA Class III (or similar life-critical medical equipment) unless authorized officers of the parties have executed a special agreement specifically governing such use.

Only those TI components which TI has specifically designated as military grade or "enhanced plastic" are designed and intended for use in military/aerospace applications or environments. Buyer acknowledges and agrees that any military or aerospace use of TI components which have **not** been so designated is solely at the Buyer's risk, and that Buyer is solely responsible for compliance with all legal and regulatory requirements in connection with such use.

TI has specifically designated certain components as meeting ISO/TS16949 requirements, mainly for automotive use. In any case of use of non-designated products, TI will not be responsible for any failure to meet ISO/TS16949.

Products

Audio	www.ti.com/audio
Amplifiers	amplifier.ti.com
Data Converters	dataconverter.ti.com
DLP® Products	www.dlp.com
DSP	dsp.ti.com
Clocks and Timers	www.ti.com/clocks
Interface	interface.ti.com
Logic	logic.ti.com
Power Mgmt	power.ti.com
Microcontrollers	microcontroller.ti.com
RFID	www.ti-rfid.com
OMAP Applications Processors	www.ti.com/omap
Wireless Connectivity	www.ti.com/wirelessconnectivity

Applications

Automotive and Transportation	www.ti.com/automotive
Communications and Telecom	www.ti.com/communications
Computers and Peripherals	www.ti.com/computers
Consumer Electronics	www.ti.com/consumer-apps
Energy and Lighting	www.ti.com/energy
Industrial	www.ti.com/industrial
Medical	www.ti.com/medical
Security	www.ti.com/security
Space, Avionics and Defense	www.ti.com/space-avionics-defense
Video and Imaging	www.ti.com/video

TI E2E Community

e2e.ti.com