

# LM4946 Boomer® Audio Power Amplifier Series Output Capacitor-Less Audio Subsystem with Programmable TI 3D

Check for Samples: [LM4946](#)

## FEATURES

- I<sup>2</sup>C/SPI Control Interface
- I<sup>2</sup>C/SPI Programmable TI 3D Audio
- I<sup>2</sup>C/SPI Controlled 32 Step Digital Volume Control (-54dB to +18dB)
- Three Independent Volume Channels (Left, Right, Mono)
- Eight Distinct Output Modes
- WQFN and DSBGA Surface Mount Packaging
- “Click and Pop” Suppression Circuitry
- Thermal Shutdown Protection
- Low Shutdown Current (0.02uA, typ)
- RF Immunity Topology

## APPLICATIONS

- Mobile Phones
- PDAs

## KEY SPECIFICATIONS

- THD+N at 1kHz, 540mW into 8Ω BTL (3.3V) 1.0% (typ)
- THD+N at 1kHz, 35mW into 32Ω SE (3.3V) 1.0% (typ)
- Single Supply Operation (VDD) 2.7 to 5.5V
- I<sup>2</sup>C/SPI Single Supply Operation
  - WQFN 2.2 to 5.5V
  - DSBGA 1.7 to 5.5V

## DESCRIPTION

The LM4946 is an audio power amplifier capable of delivering 540mW of continuous average power into a mono 8Ω bridged-tied load (BTL) with 1% THD+N, 35mW per channel of continuous average power into stereo 32Ω single-ended (SE) loads with 1% THD+N, or an output capacitor-less (OCL) configuration with identical specifications as the SE configuration, from a 3.3V power supply.

The LM4946 has three input channels: one pair for a two-channel stereo signal and the third for a differential single-channel mono input. The LM4946 features a 32-step digital volume control and eight distinct output modes. The digital volume control, 3D enhancement, and output modes (mono/SE/OCL) are programmed through a two-wire I<sup>2</sup>C or a three-wire SPI compatible interface that allows flexibility in routing and mixing audio channels.

The LM4946 is designed for cellular phone, PDA, and other portable handheld applications. It delivers high quality output power from a surface-mount package and requires only seven external components in the OCL mode (two additional components in SE mode).



Please be aware that an important notice concerning availability, standard warranty, and use in critical applications of Texas Instruments semiconductor products and disclaimers thereto appears at the end of this data sheet.

All trademarks are the property of their respective owners.

Typical Application

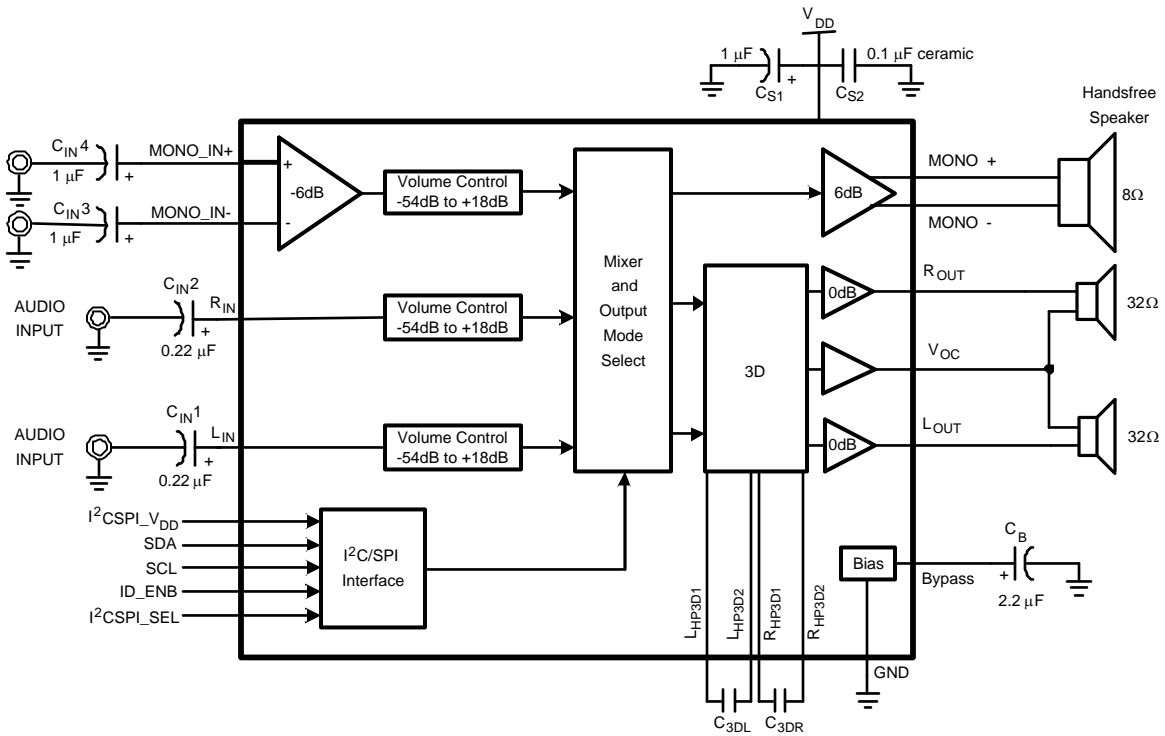

Figure 1. Typical Audio Amplifier Application Circuit-Output Capacitor-less

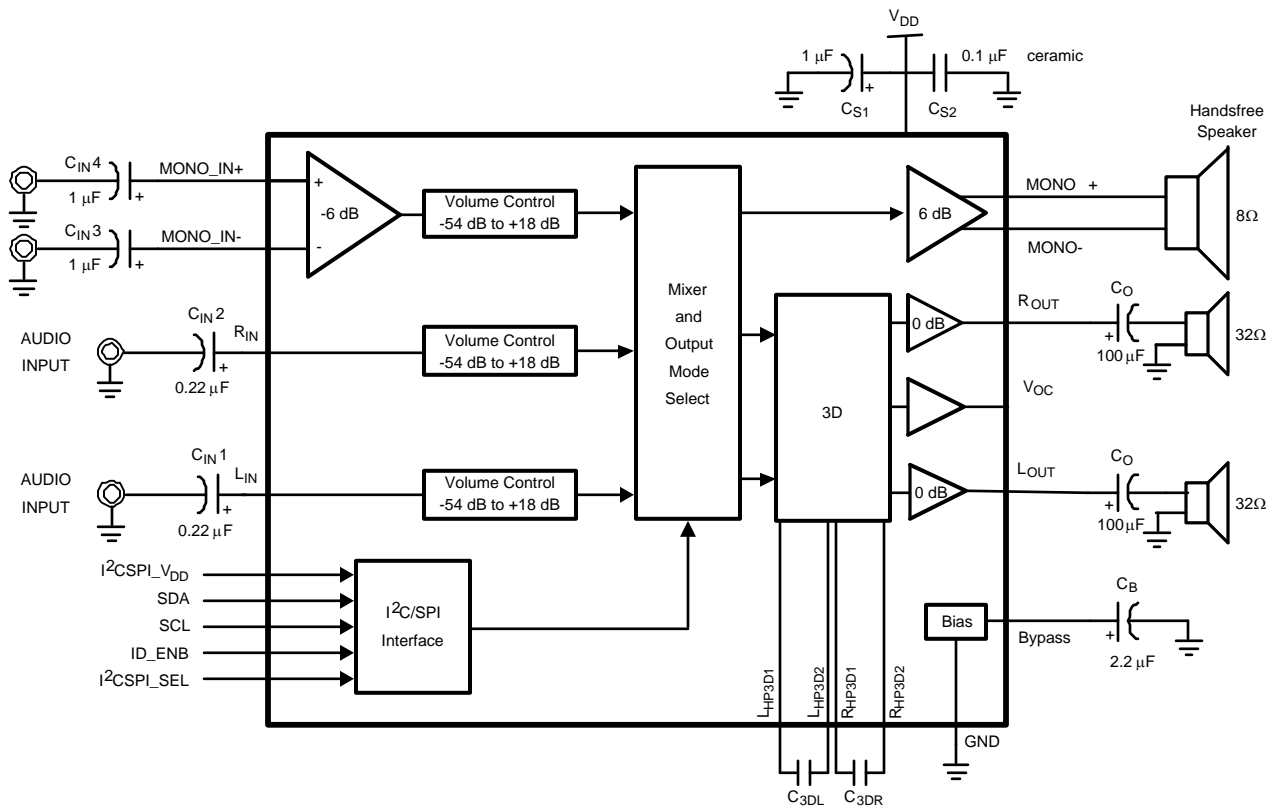

Figure 2. Typical Audio Amplifier Application Circuit-Single Ended

Connection Diagram

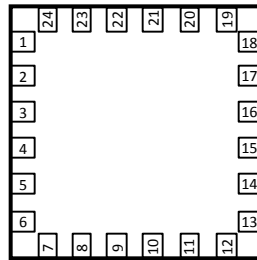

Figure 3. 24 Lead WQFN Package (Top View)

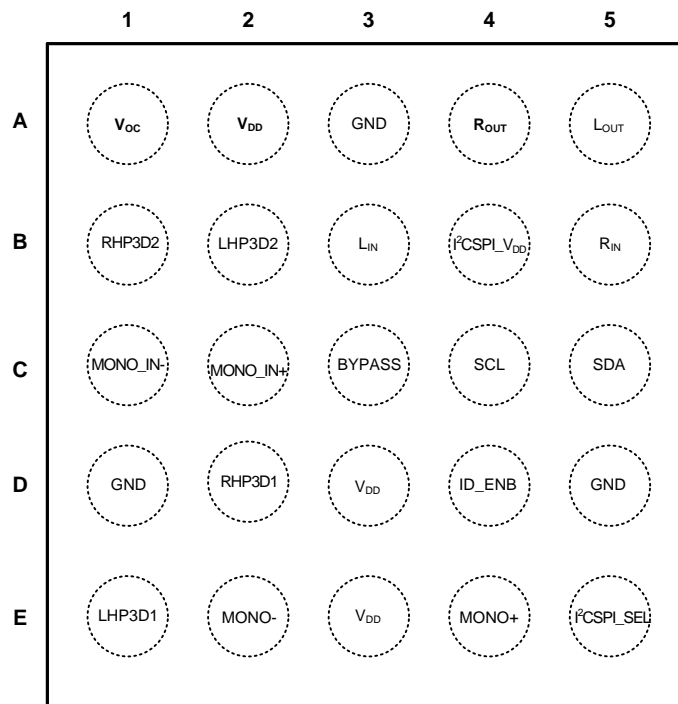

Figure 4. 25 Bump DSBGA Package (Top View)

**PIN DESCRIPTIONS**

Pin Number (WQFN)	Bump (DSBGA)	Name	Description
1	B2	LHP3D2	Left Headphone 3D Input 1
2	A1	V <sub>OC</sub>	Center Amplifier Output
3	A2	V <sub>DD</sub>	Voltage Supply
4	A3	GND	Ground
5	A4	R <sub>OUT</sub>	Right Headphone Output
6	A5	L <sub>OUT</sub>	Left Headphone Output
7	B4	I <sup>2</sup> C/SPI_V <sub>DD</sub>	I <sup>2</sup> C or SPI Interface Voltage Supply
8	B5	R <sub>IN</sub>	Right Input Channel
9	B3	L <sub>IN</sub>	Left Input Channel
10	C5	SDA	Data
11	C4	SCL	Clock
12	D5	GND	Ground
13	D4	ID_ENB	Address Identification/Enable Bar
14	E5	I <sup>2</sup> C/SPI_SEL	I <sup>2</sup> C or SPI Select
15	E4	MONO+	Loudspeaker Output Positive
16	D3	V <sub>DD</sub>	Voltage Supply
17	E2	MONO-	Loudspeaker Output Negative
18	E1	LHP3D1	Left Headphone 3D Input 2
19	D2	RHP3D1	Right Headphone 3D Input 1
20	D1	GND	Ground
21	C3	BYPASS	Half-Supply Bypass
22	C1	MONO_IN-	Loudspeaker Negative Input
23	C2	MONO_IN+	Loudspeaker Positive Input
24	B1	RHP3D2	Right Headphone 3D Input 2
	E3	V <sub>DD</sub>	Voltage Supply



These devices have limited built-in ESD protection. The leads should be shorted together or the device placed in conductive foam during storage or handling to prevent electrostatic damage to the MOS gates.

### Absolute Maximum Ratings<sup>(1)(2)</sup>

Supply Voltage		6.0V
Storage Temperature		-65°C to +150°C
Input Voltage		-0.3 to $V_{DD} + 0.3$
ESD Susceptibility <sup>(3)</sup>		2.0kV
ESD Machine model <sup>(4)</sup>		200V
Junction Temperature		150°C
Soldering Information	Vapor Phase (60 sec.)	215°C
	Infrared (15 sec.)	220°C
Thermal Resistance <sup>(5)</sup>	$\theta_{JA}$ (typ) - RTW0024A	46°C/W
	$\theta_{JA}$ (typ) - YFQ0025	49°C/W

- (1) Operating Ratings indicate conditions for which the device is functional, but do not ensure specific performance limits. For ensured specifications and test conditions, see the Electrical Characteristics. The ensured specifications apply only for the test conditions listed. Some performance characteristics may degrade when the device is not operated under the listed test conditions.
- (2) If Military/Aerospace specified devices are required, please contact the Texas Instruments Sales Office/Distributors for availability and specifications.
- (3) Human body model, 100pF discharged through a 1.5k $\Omega$  resistor.
- (4) Machine Model ESD test is covered by specification EIAJ IC-121-1981. A 200pF cap is charged to the specified voltage, then discharged directly into the IC with no external series resistor (resistance of discharge path must be under 50 $\Omega$ ).
- (5) The given  $\theta_{JA}$  for an LM4946SQ mounted on a demonstration board with a 9in<sup>2</sup> area of 1oz printed circuit board copper ground plane.

### Operating Ratings

Temperature Range	-40°C to 85°C
Supply Voltage ( $V_{DD}$ )	$2.7V \leq V_{DD} \leq 5.5V$
Supply Voltage ( $I^2C/SPI$ ) <sup>(1)</sup>	$I^2CSPI\_V_{DD} \leq V_{DD}$
WQFN	$2.2V \leq I^2CSPI\_V_{DD} \leq 5.5V$
DSBGA	$1.7V \leq I^2CSPI\_V_{DD} \leq 5.5V$

- (1) Refer to this [table](#).

### Electrical Characteristics 3.3V<sup>(1)(2)</sup>

The following specifications apply for  $V_{DD} = 3.3V$ ,  $T_A = 25^\circ C$ , all volume controls set to 0dB, unless otherwise specified.

Symbol	Parameter	Conditions	LM4946		Units (Limits) <sup>(3)</sup>
			Typical <sup>(4)</sup>	Limits <sup>(5)</sup>	
$I_{DD}$	Supply Current	Output Modes 2, 4, 6 $V_{IN} = 0V$ ; No load, SE Headphone	3.25		mA
		Output Modes 1, 3, 5, 7 $V_{IN} = 0V$ ; No load, SE Headphone	5.65		mA
		Output Modes 2, 4, 6 $V_{IN} = 0V$ ; No load, OCL Headphone	4	6.5	mA (max)
		Output Modes 1, 3, 5, $V_{IN} = 0V$ ; No load, OCL Headphone	5		mA
		Output Modes 7 $V_{IN} = 0V$ ; No load, OCL Headphone	6.5	10.5	mA (max)
$I_{SD}$	Shutdown Current	Output Mode 0	0.02	1	$\mu A$ (max)
$V_{OS}$	Output Offset Voltage	$V_{IN} = 0V$ , Mode 7 Mono	12	50	mV (max)
		$V_{IN} = 0V$ , Mode 7 Headphones (Note 11)	3	15	
$P_O$	Output Power	MONO <sub>OUT</sub> ; $R_L = 8\Omega$ THD+N = 1%; $f = 1kHz$ , BTL, Mode 1	540	500	mW (min)
		$R_{OUT}$ and $L_{OUT}$ ; $R_L = 32\Omega$ THD+N = 1%; $f = 1kHz$ , SE, Mode 4	35	30	mW (min)
THD+N	Total Harmonic Distortion + Noise	MONO <sub>OUT</sub> $f = 1kHz$ $P_{OUT} = 250mW$ ; $R_L = 8\Omega$ , BTL, Mode 1	0.05		%
		$R_{OUT}$ and $L_{OUT}$ $f = 1kHz$ $P_{OUT} = 12mW$ ; $R_L = 32\Omega$ , SE, Mode 4	0.015		%
$N_{OUT}$	Output Noise	A-weighted, inputs terminated to GND, output referred			
		Speaker; Mode 1	17		$\mu V$
		Speaker; Mode 3, 7	27		$\mu V$
		Speaker; Mode 5	33		$\mu V$
		Headphone; SE, Mode 2	8		$\mu V$
		Headphone; SE, Mode 4, 7	8		$\mu V$
		Headphone; SE, Mode 6	12		$\mu V$
		Headphone; OCL, Mode 2	8		$\mu V$
		Headphone; OCL, Mode 4, 7	9		$\mu V$
Headphone; OCL, Mode 6	12		$\mu V$		

- (1) Operating Ratings indicate conditions for which the device is functional, but do not ensure specific performance limits. For ensured specifications and test conditions, see the Electrical Characteristics. The ensured specifications apply only for the test conditions listed. Some performance characteristics may degrade when the device is not operated under the listed test conditions.
- (2) All voltages are measured with respect to the ground pin, unless otherwise specified.
- (3) Datasheet min/max specifications are specified by design, test, or statistical analysis.
- (4) Typical specifications are specified at  $+25^\circ C$  and represent the most likely parametric norm.
- (5) Tested limits are specified to TI's AOQL (Average Outgoing Quality Level).

**Electrical Characteristics 3.3V<sup>(1)(2)</sup> (continued)**

 The following specifications apply for  $V_{DD} = 3.3V$ ,  $T_A = 25^\circ C$ , all volume controls set to 0dB, unless otherwise specified.

Symbol	Parameter	Conditions	LM4946		Units (Limits) <sup>(3)</sup>
			Typical <sup>(4)</sup>	Limits <sup>(5)</sup>	
PSRR	Power Supply Rejection Ratio MONO <sub>OUT</sub>	$V_{RIPPLE} = 200mV_{PP}$ ; $f = 217Hz$ , $R_L = 8\Omega$ $C_B = 2.2\mu F$ , BTL All audio inputs terminated to GND; output referred			
		BTL, Output Mode 1	76		dB
		BTL, Output Mode 3, 7	65		dB
		BTL, Output Mode 5	63		dB
	Power Supply Rejection Ratio R <sub>OUT</sub> and L <sub>OUT</sub>	$V_{RIPPLE} = 200mV_{PP}$ ; $f = 217Hz$ , $R_L = 32\Omega$ $C_B = 2.2\mu F$ , All audio inputs terminated to GND output referred			
		SE, Output Mode 2	78		dB
		SE, Output Mode 4,7	82		dB
		SE, Output Mode 6	78		dB
		OCL, Output Mode 2	84		dB
		OCL, Output Mode 4, 7	78		dB
OCL, Output Mode 6	77		dB		
	Volume Control Step Size Error		±0.2		dB
	Digital Volume Control Range	Maximum attenuation	-54	-56 -52	dB (max) dB (min)
		Maximum gain	18	17.4 18.6	dB (min) dB (max)
	HP(SE) Mute Attenuation	Output Mode 1, 3, 5	96		dB
	MONO_IN Input Impedance R <sub>IN</sub> and L <sub>IN</sub> Input Impedance	Maximum gain setting	12.5	10 15	kΩ (min) kΩ (max)
		Maximum attenuation setting	110	90 130	kΩ (min) kΩ (max)
CMRR	Common-Mode Rejection Ratio	$f = 217Hz$ , $V_{CM} = 1V_{pp}$ , Mode 1, BTL, $R_L = 8\Omega$	61		dB
		$f = 217Hz$ , $V_{CM} = 1V_{pp}$ , Mode 2, $R_L = 32\Omega$	66		
XTALK	Crosstalk	Headphone; $P_O = 12mW$ $f = 1kHz$ , OCL, Mode 4	-54		dB
		Headphone; $P_O = 12mW$ $f = 1kHz$ , SE, Mode 4	-72		dB
T <sub>WU</sub>	Wake-Up Time from Shutdown	$C_B = 2.2\mu F$ , OCL	100		ms
		$C_B = 2.2\mu F$ , SE	135		ms

## Electrical Characteristics 5.0V<sup>(1)(2)</sup>

The following specifications apply for  $V_{DD} = 5.0V$ ,  $T_A = 25^\circ C$ , all volume controls set to 0dB, unless otherwise specified.

Symbol	Parameter	Conditions	LM4946		Units (Limits) <sup>(3)</sup>
			Typical <sup>(4)</sup>	Limits <sup>(5)</sup>	
$I_{DD}$	Supply Current	Output Modes 2, 4, 6 $V_{IN} = 0V$ ; No load SE Headphone	3.8		mA
		Output Modes 1, 3, 5, 7 $V_{IN} = 0V$ ; No Load, SE Headphone	6.6		mA
		Output Modes 2, 4, 6 $V_{IN} = 0V$ ; No load, OCL Headphone	4.6		mA
		Output Modes 1, 3, 5 $V_{IN} = 0V$ ; No Load, OCL Headphone	6		mA
		Output Modes 7 $V_{IN} = 0V$ ; No Load, OCL Headphone	7.4		mA
$I_{SD}$	Shutdown Current	Output Mode 0	0.05		$\mu A$
$V_{OS}$	Output Offset Voltage	$V_{IN} = 0V$ , Mode 7 Mono	12		mV
		$V_{IN} = 0V$ , Mode 7 Headphones	3		
$P_O$	Output Power	MONO <sub>OUT</sub> ; $R_L = 8\Omega$ THD+N = 1%; $f = 1kHz$ , BTL, Mode 1	1.3		W
		$R_{OUT}$ and $L_{OUT}$ ; $R_L = 32\Omega$ THD+N = 1%; $f = 1kHz$ , SE, Mode 4	85		mW
THD+N	Total Harmonic Distortion + Noise	MONO <sub>OUT</sub> , $f = 1kHz$ $P_{OUT} = 500mW$ ; $R_L = 8\Omega$ , BTL, Mode 1	0.05		%
		$R_{OUT}$ and $L_{OUT}$ , $f = 1kHz$ $P_{OUT} = 30mW$ ; $R_L = 32\Omega$ , SE, Mode 4	0.012		%
$N_{OUT}$	Output Noise	A-weighted, inputs terminated to GND, output referred			
		Speaker; Mode 1	17		$\mu V$
		Speaker; Mode 3, 7	27		$\mu V$
		Speaker; Mode 5	33		$\mu V$
		Headphone; SE, Mode 2	8		$\mu V$
		Headphone; SE, Mode 4, 7	8		$\mu V$
		Headphone; SE, Mode 6	12		$\mu V$
		Headphone; OCL, Mode 2	8		$\mu V$
		Headphone; OCL, Mode 4, 7	9		$\mu V$
Headphone; OCL, Mode 6	12		$\mu V$		
PSRR	Power Supply rejection Ratio MONO <sub>OUT</sub>	$V_{RIPPLE} = 200mV_{PP}$ ; $f = 217Hz$ , $R_L = 8\Omega$ $C_B = 2.2\mu F$ , BTL All audio inputs terminated to GND; output referred			
		BTL, Output Mode 1	69		dB
		BTL, Output Mode 3, 7	60		dB
		BTL, Output Mode 5	58		dB

- (1) Operating Ratings indicate conditions for which the device is functional, but do not ensure specific performance limits. For ensured specifications and test conditions, see the Electrical Characteristics. The ensured specifications apply only for the test conditions listed. Some performance characteristics may degrade when the device is not operated under the listed test conditions.
- (2) All voltages are measured with respect to the ground pin, unless otherwise specified.
- (3) Datasheet min/max specifications are specified by design, test, or statistical analysis.
- (4) Typical specifications are specified at  $+25^\circ C$  and represent the most likely parametric norm.
- (5) Tested limits are specified to TI's AOQL (Average Outgoing Quality Level).



## Electrical Characteristics 5.0V<sup>(1)(2)</sup> (continued)

The following specifications apply for  $V_{DD} = 5.0V$ ,  $T_A = 25^\circ C$ , all volume controls set to 0dB, unless otherwise specified.

Symbol	Parameter	Conditions	LM4946		Units (Limits) <sup>(3)</sup>
			Typical <sup>(4)</sup>	Limits <sup>(5)</sup>	
PSRR	Power Supply Rejection Ratio $R_{OUT}$ and $L_{OUT}$	$V_{RIPPLE} = 200mV_{PP}$ ; $f = 217Hz$ , $R_L = 32\Omega$ $C_B = 2.2\mu F$ , BTL All audio inputs terminated to GND; output referred			
		SE, Output Mode 2	75		dB
		SE, Output Mode 4,7	75		dB
		SE, Output Mode 6	72		dB
		OCL, Output Mode 2	75		dB
		OCL, Output Mode 4, 7	79		dB
		OCL, Output Mode 6	72		dB
	Digital Volume Control Range	Maximum attenuation	-54	-56 -52	dB (max) dB (min)
		Maximum gain	18	17.4 18.6	dB (min) dB (max)
	HP(SE) Mute Attenuation	Output Mode 1, 3, 5	96		dB
	MONO_IN Input Impedance $R_{IN}$ and $L_{IN}$ Input Impedance	Maximum gain setting	12.5	10 15	k $\Omega$ (min) k $\Omega$ (max)
		Maximum attenuation setting	110	90 130	k $\Omega$ (min) k $\Omega$ (max)
CMRR	Common-Mode Rejection Ratio	$f = 217Hz$ , $V_{CM} = 1V_{pp}$ , 0dB gain Mode 1, BTL, $R_L = 8\Omega$	61		dB
		$f = 217Hz$ , $V_{CM} = 1V_{pp}$ , 0dB gain Mode 2, $R_L = 32\Omega$	66		
XTALK	Crosstalk	Headphone; $P_O = 30mW$ , OCL, Mode 4	-55		dB
		Headphone; $P_O = 30mW$ , SE, Mode 4	-72		dB
TWU	Wake-Up Time from Shutdown	$C_B = 2.2\mu F$ , OCL	135		ms
		$C_B = 2.2\mu F$ , SE	180		ms

## I<sup>2</sup>C/SPI WQFN/DSBGA<sup>(1)(2)</sup>

The following specifications apply for  $V_{DD} = 5.0V$  and  $3.3V$ ,  $T_A = 25^\circ C$ ,  $2.2V \leq I^2C/SPI_{V_{DD}} \leq 5.5V$ , unless otherwise specified.

Symbol	Parameter	Conditions	LM4946 <sup>(3)</sup>		Units (Limits) <sup>(4)</sup>
			Typical <sup>(5)</sup>	Limits <sup>(6) (2)</sup>	
$t_1$	I <sup>2</sup> C Clock Period			2.5	$\mu s$ (min)
$t_2$	I <sup>2</sup> C Data Setup Time			100	ns (min)
$t_3$	I <sup>2</sup> C Data Stable Time			0	ns (min)
$t_4$	Start Condition Time			100	ns (min)
$t_5$	Stop Condition Time			100	ns (min)
$t_6$	I <sup>2</sup> C Data Hold Time			100	ns (min)
$f_{SPI}$	Maximum SPI Frequency			1000	kHz (max)
$t_{EL}$	SPI ENB High Time			100	ns (min)
$t_{DS}$	SPI Data Setup Time			100	ns (min)
$t_{ES}$	SPI ENB Setup Time			100	ns (min)

- (1) Operating Ratings indicate conditions for which the device is functional, but do not ensure specific performance limits. For ensured specifications and test conditions, see the Electrical Characteristics. The ensured specifications apply only for the test conditions listed. Some performance characteristics may degrade when the device is not operated under the listed test conditions.
- (2) All voltages are measured with respect to the ground pin, unless otherwise specified.
- (3) For LM4946 WQFN package, revised specification goes into effect starting with date code 79. Existing specification is per datasheet rev 1.0
- (4) Datasheet min/max specifications are specified by design, test, or statistical analysis.
- (5) Typical specifications are specified at +25°C and represent the most likely parametric norm.
- (6) Tested limits are specified to TI's AOQL (Average Outgoing Quality Level).

### I<sup>2</sup>C/SPI WQFN/DSBGA<sup>(1)(2)</sup> (continued)

The following specifications apply for  $V_{DD} = 5.0V$  and  $3.3V$ ,  $T_A = 25^\circ C$ ,  $2.2V \leq I^2C/SPI_{V_{DD}} \leq 5.5V$ , unless otherwise specified.

Symbol	Parameter	Conditions	LM4946 <sup>(3)</sup>		Units (Limits) <sup>(4)</sup>
			Typical <sup>(5)</sup>	Limits <sup>(6) (2)</sup>	
$t_{DH}$	SPI Data Hold Time			100	ns (min)
$t_{EH}$	SPI Enable Hold Time			100	ns (min)
$t_{CL}$	SPI Clock Low Time			500	ns (min)
$t_{CH}$	SPI Clock High Time			500	ns (min)
$V_{IH}$	I <sup>2</sup> C/SPI Input Voltage High			$0.7 \times I^2C/SPI_{V_{DD}}$	V (min)
$V_{IL}$	I <sup>2</sup> C/SPI Input Voltage Low			$0.3 \times I^2C/SPI_{V_{DD}}$	V (max)

### I<sup>2</sup>C/SPI DSBGA only<sup>(1)(2)</sup>

The following specifications apply for  $V_{DD} = 5.0V$  and  $3.3V$ ,  $T_A = 25^\circ C$ ,  $1.7V \leq I^2C/SPI_{V_{DD}} \leq 2.2V$ , unless otherwise specified.

Symbol	Parameter	Conditions	LM4946		Units (Limits) <sup>(3)</sup>
			Typical <sup>(4)</sup>	Limits <sup>(5) (2)</sup>	
$t_1$	I <sup>2</sup> C Clock Period			2.5	$\mu s$ (min)
$t_2$	I <sup>2</sup> C Data Setup Time			250	ns (min)
$t_3$	I <sup>2</sup> C Data Stable Time			0	ns (min)
$t_4$	Start Condition Time			250	ns (min)
$t_5$	Stop Condition Time			250	ns (min)
$t_6$	I <sup>2</sup> C Data Hold Time			250	ns (min)
$f_{SPI}$	Maximum SPI Frequency			250	kHz (max)
$t_{EL}$	SPI ENB High Time			250	ns (min)
$t_{DS}$	SPI Data Setup Time			250	ns (min)
$t_{ES}$	SPI ENB Setup Time			250	ns (min)
$t_{DH}$	SPI Data Hold Time			250	ns (min)
$t_{EH}$	SPI Enable Hold Time			250	ns (min)
$t_{CL}$	SPI Clock Low Time			500	ns (min)
$t_{CH}$	SPI Clock High Time			500	ns (min)
$V_{IH}$	I <sup>2</sup> C/SPI Input Voltage High			$0.7 \times I^2C/SPI_{V_{DD}}$	V (min)
$V_{IL}$	I <sup>2</sup> C/SPI Input Voltage Low			$0.25 \times I^2C/SPI_{V_{DD}}$	V (max)

- (1) Operating Ratings indicate conditions for which the device is functional, but do not ensure specific performance limits. For ensured specifications and test conditions, see the Electrical Characteristics. The ensured specifications apply only for the test conditions listed. Some performance characteristics may degrade when the device is not operated under the listed test conditions.
- (2) All voltages are measured with respect to the ground pin, unless otherwise specified.
- (3) Datasheet min/max specifications are specified by design, test, or statistical analysis.
- (4) Typical specifications are specified at  $+25^\circ C$  and represent the most likely parametric norm.
- (5) Tested limits are specified to TI's AOQL (Average Outgoing Quality Level).

Typical Performance Characteristics

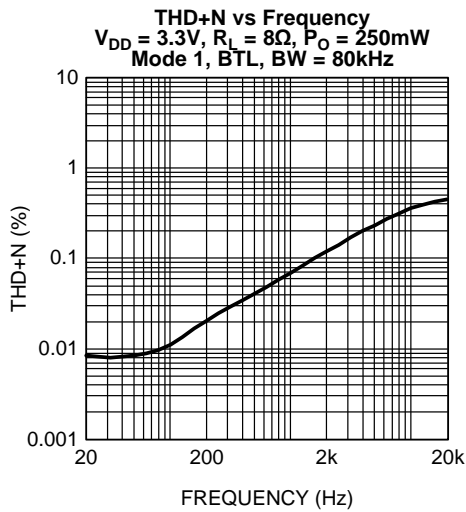

Figure 5.

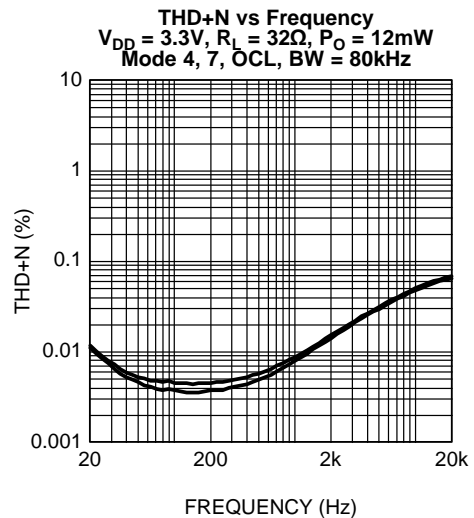

Figure 6.

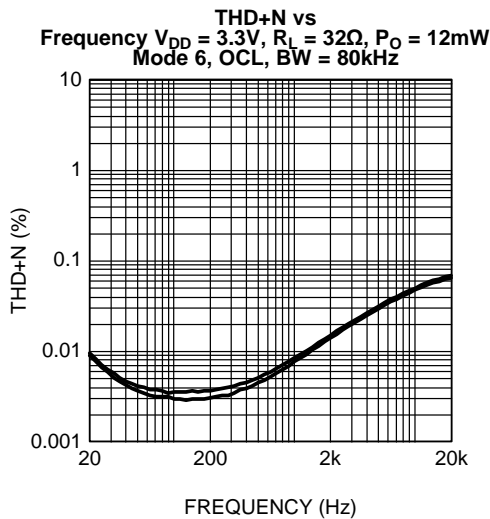

Figure 7.

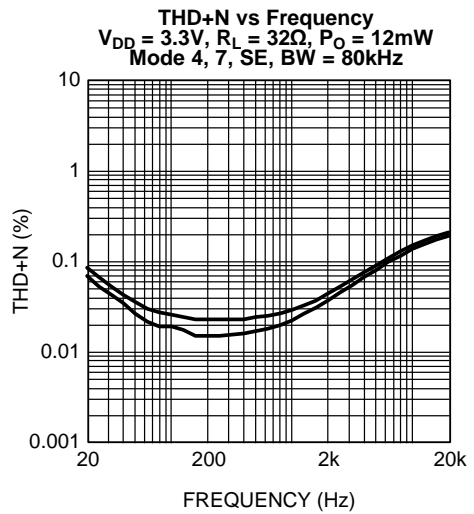

Figure 8.

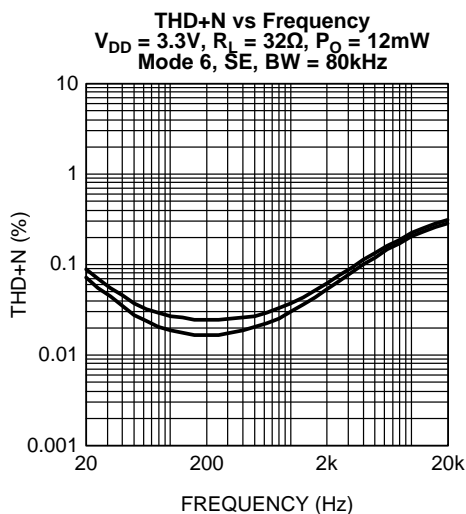

Figure 9.

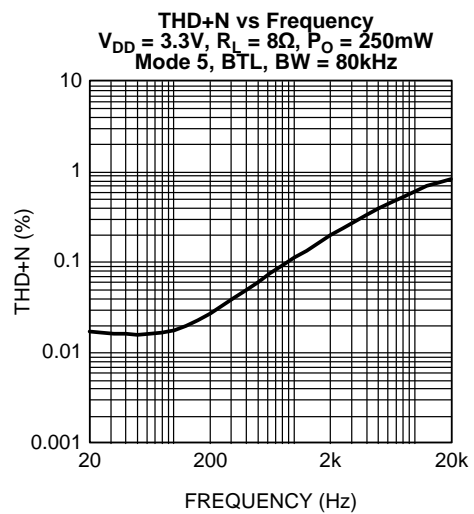

Figure 10.

Typical Performance Characteristics (continued)

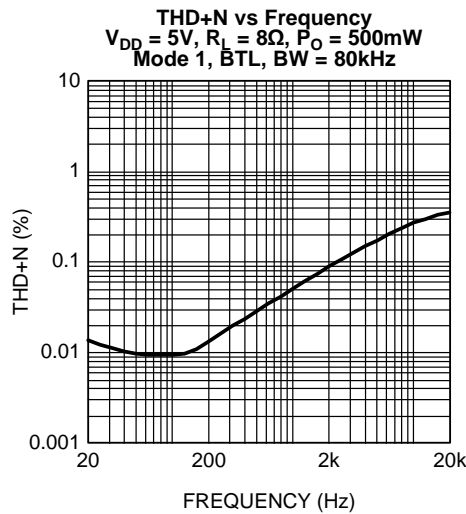

Figure 11.

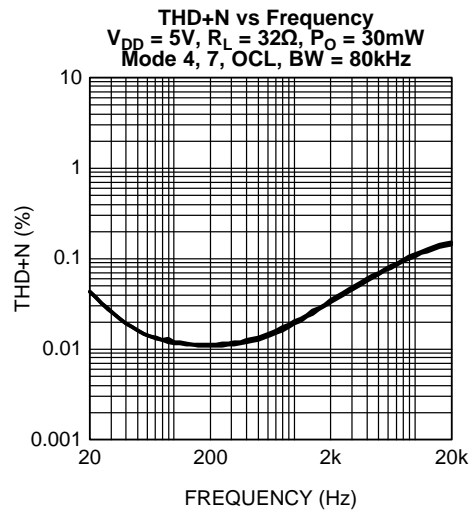

Figure 12.

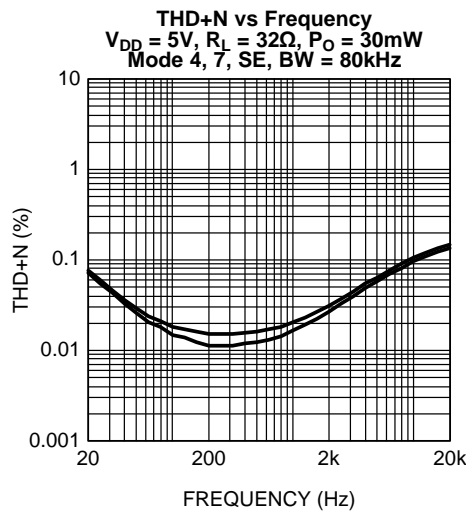

Figure 13.

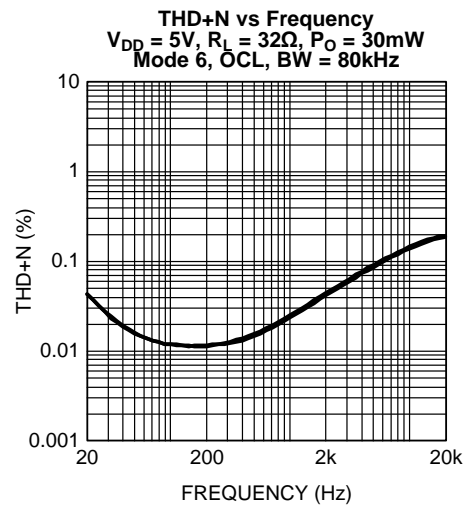

Figure 14.

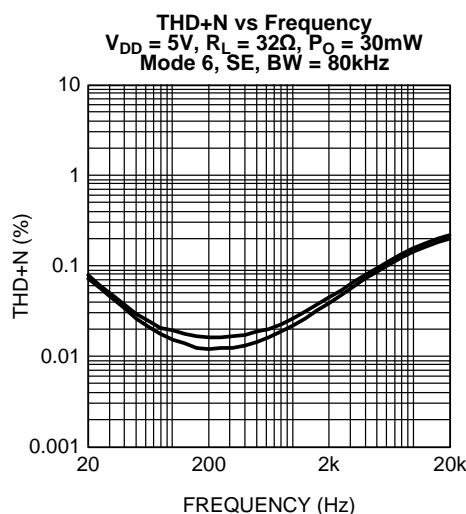

Figure 15.

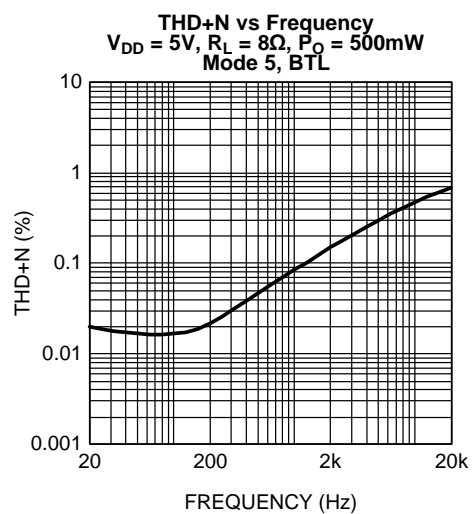

Figure 16.

**Typical Performance Characteristics (continued)**

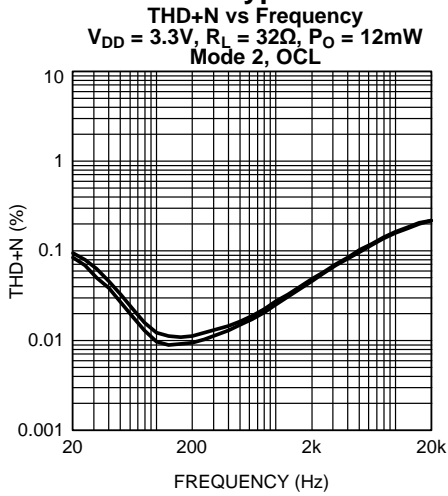

Figure 17.

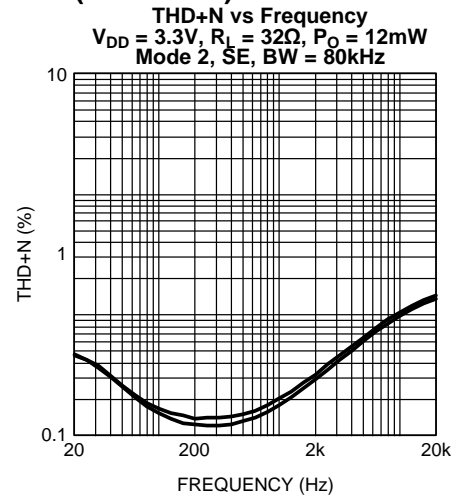

Figure 18.

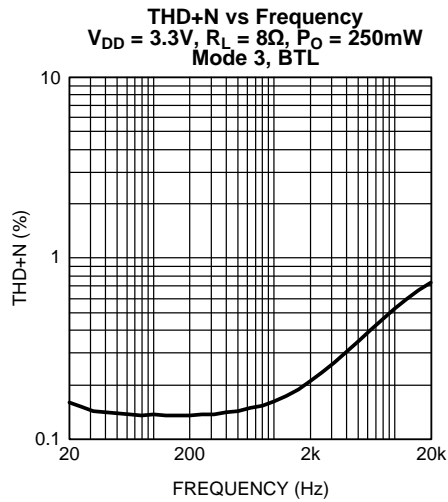

Figure 19.

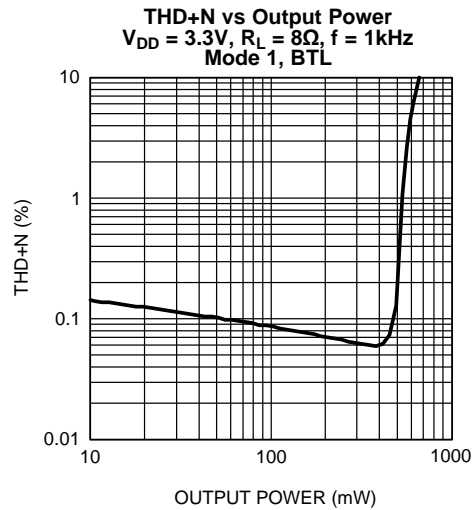

Figure 20.

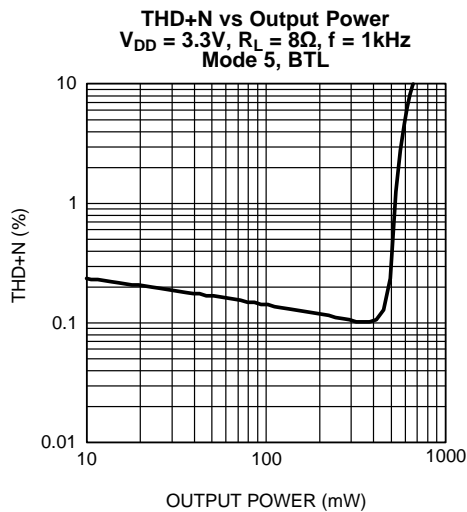

Figure 21.

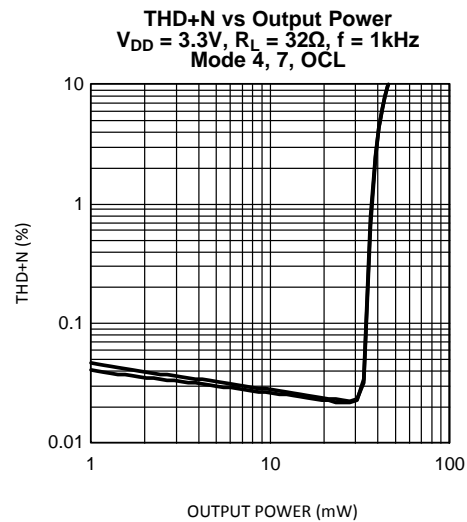
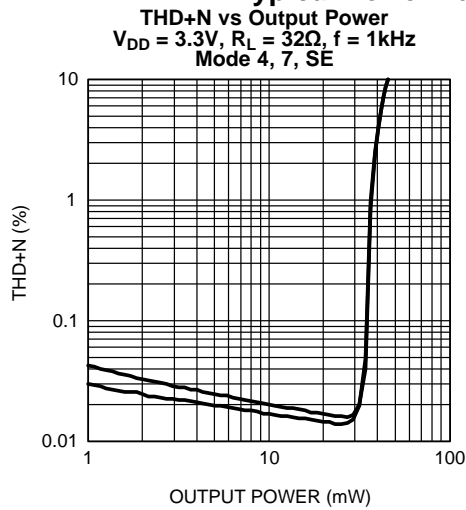
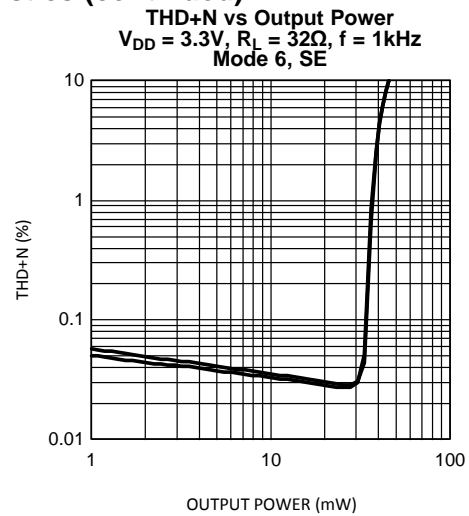

Figure 22.

**Typical Performance Characteristics (continued)**



**Figure 23.**



**Figure 24.**

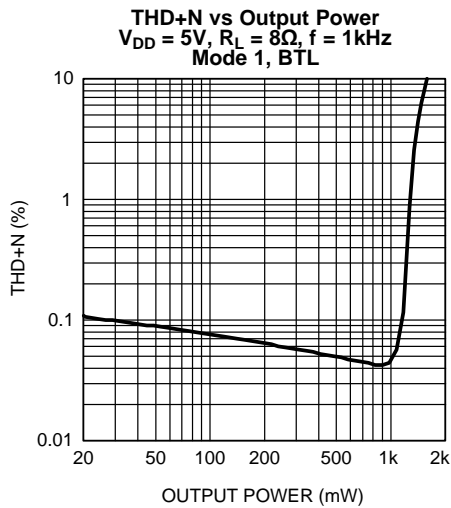

**Figure 25.**

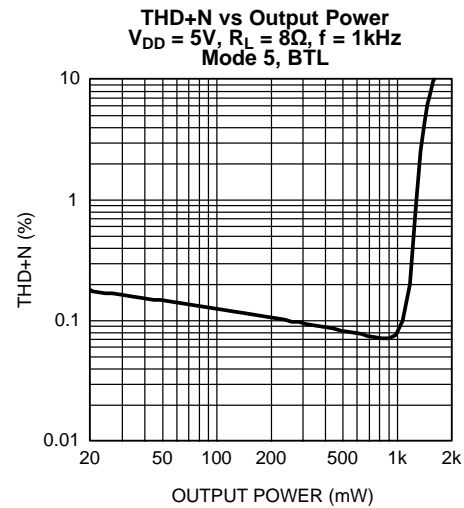

**Figure 26.**

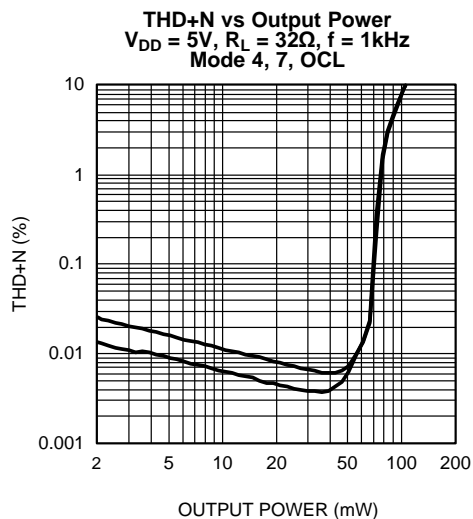

**Figure 27.**

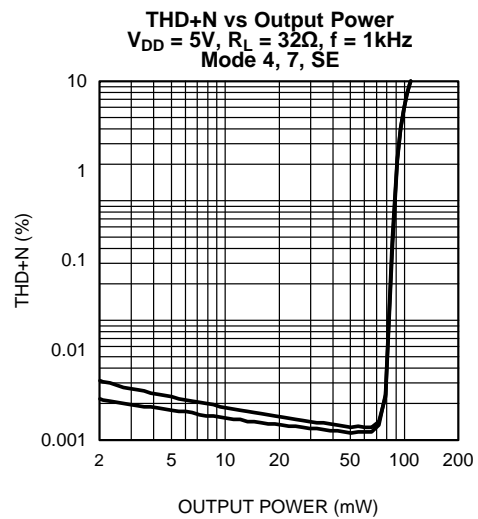

**Figure 28.**

**Typical Performance Characteristics (continued)**

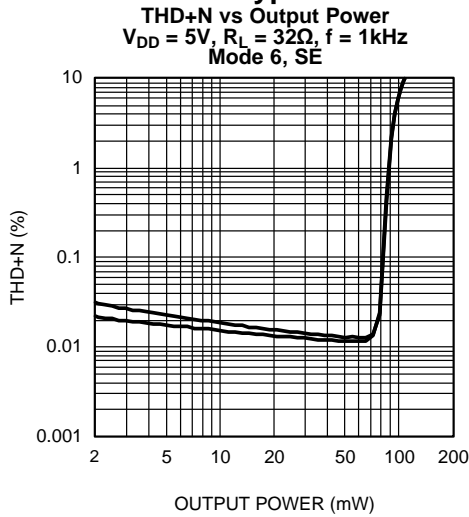

Figure 29.

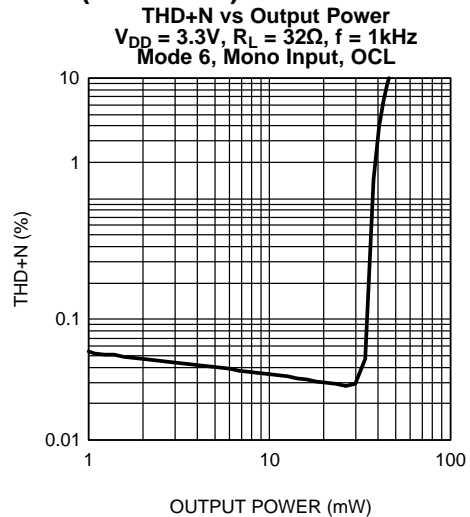

Figure 30.

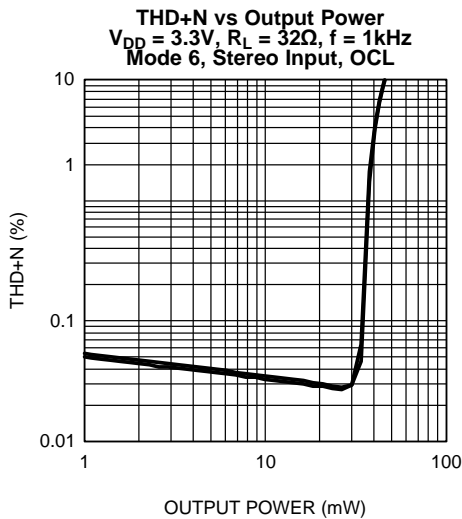

Figure 31.

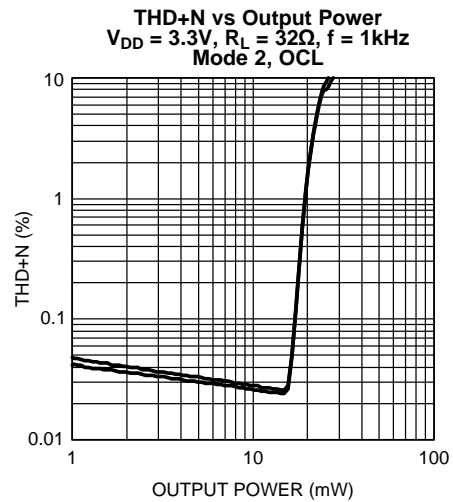

Figure 32.

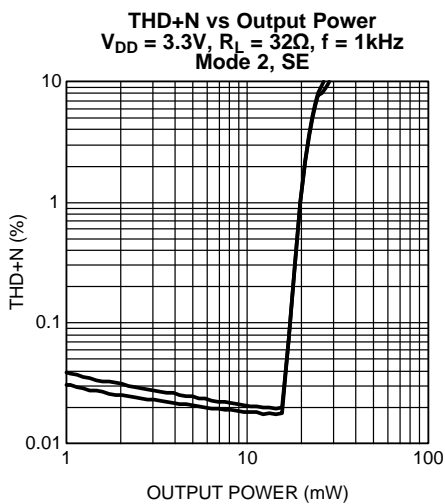

Figure 33.

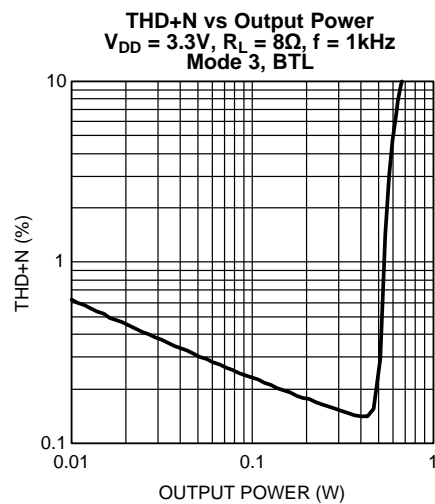

Figure 34.

**Typical Performance Characteristics (continued)**

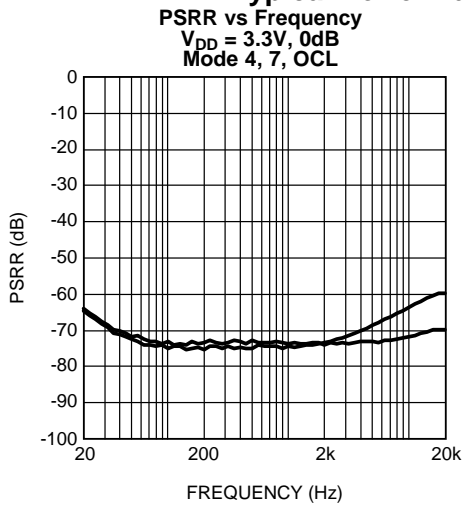

Figure 35.

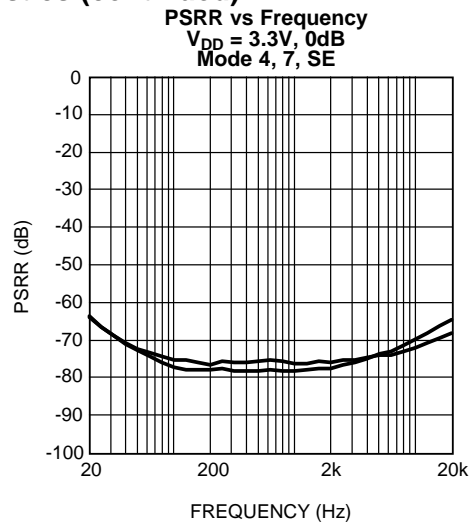

Figure 36.

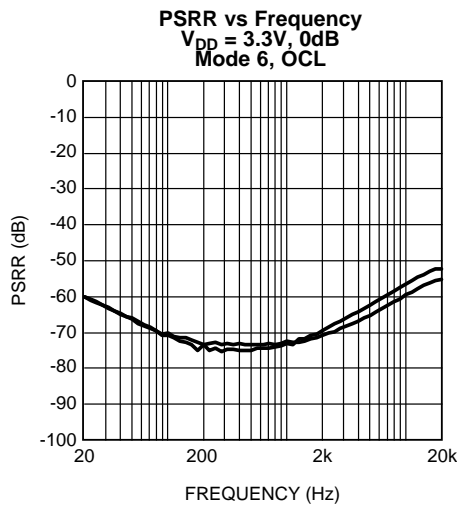

Figure 37.

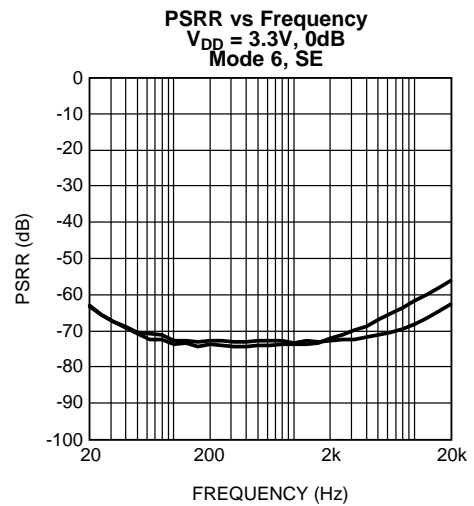

Figure 38.

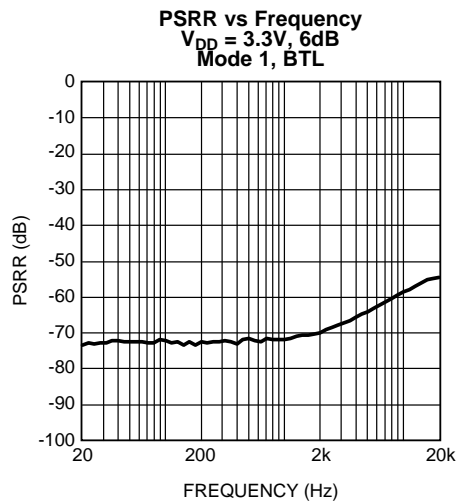

Figure 39.

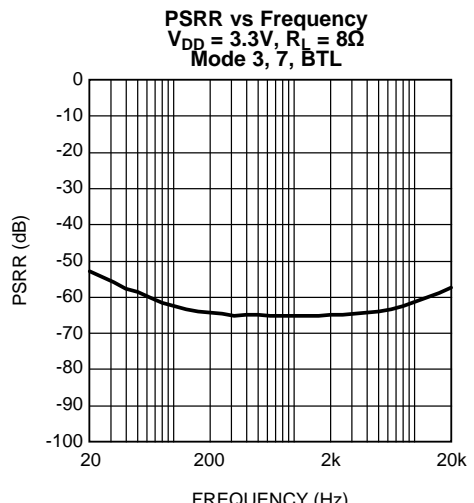

Figure 40.



Typical Performance Characteristics (continued)

PSRR vs Frequency  
 $V_{DD} = 3.3V$ ,  $R_L = 32\Omega$   
 Mode 2, OCL

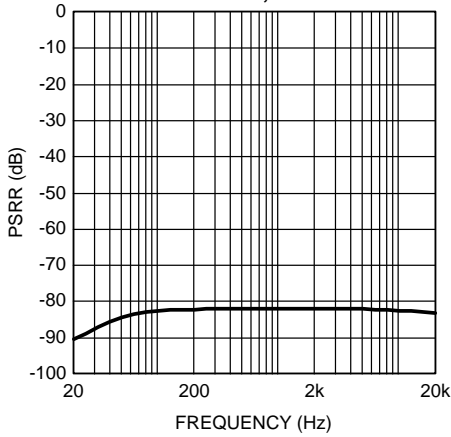

Figure 41.

PSRR vs Frequency  
 $V_{DD} = 3.3V$ ,  $R_L = 8\Omega$   
 Mode 2, SE

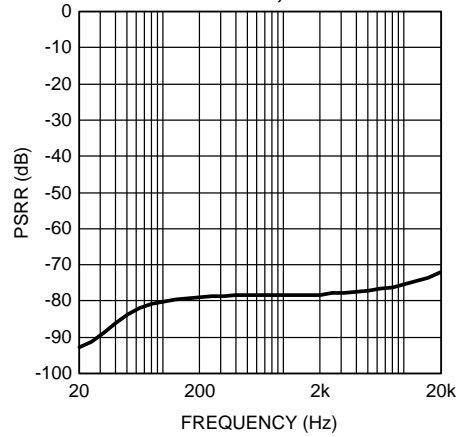

Figure 42.

PSRR vs Frequency  
 $V_{DD} = 3.3V$ , 6dB  
 Mode 5, BTL

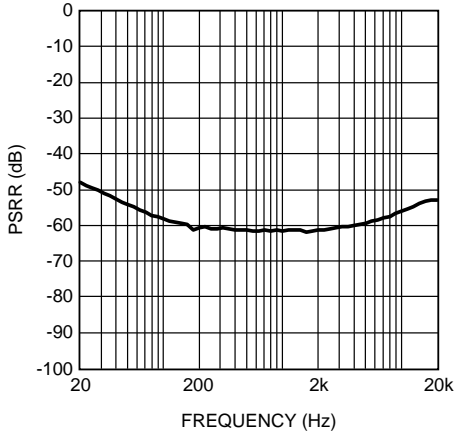

Figure 43.

PSRR vs Supply Voltage  
 $R_L = 8\Omega$ , 217Hz  
 Mode 1, BTL

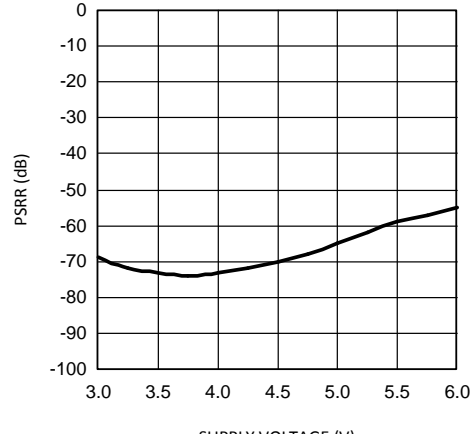

Figure 44.

PSRR vs Supply Voltage  
 $R_L = 32\Omega$ , 217Hz  
 Mode 4, OCL

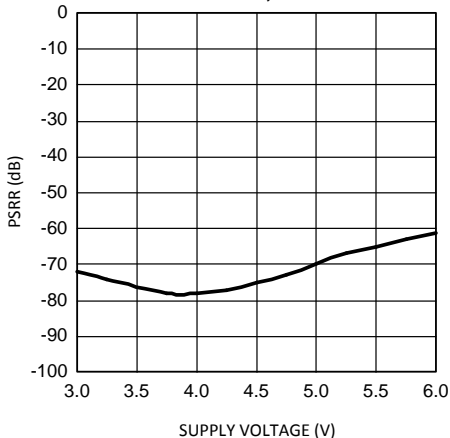

Figure 45.

PSRR vs Supply Voltage  
 $R_L = 32\Omega$ , 217Hz  
 Mode 4, SE

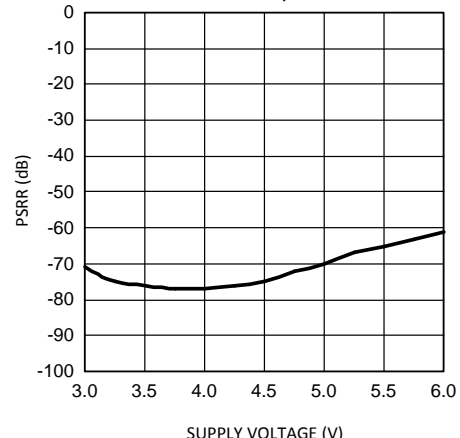

Figure 46.

**Typical Performance Characteristics (continued)**

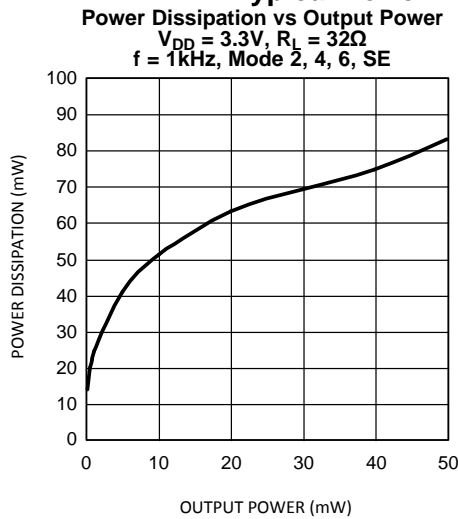

Figure 47.

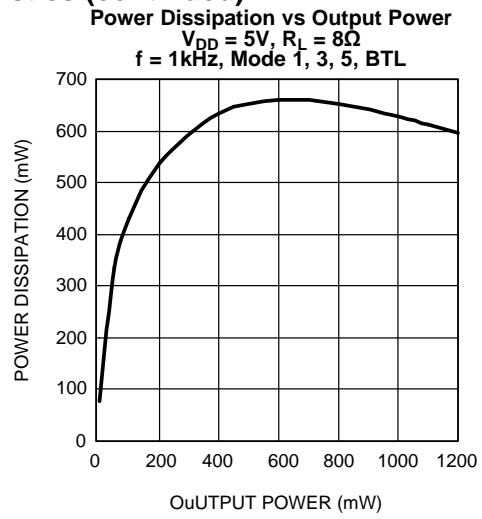

Figure 48.

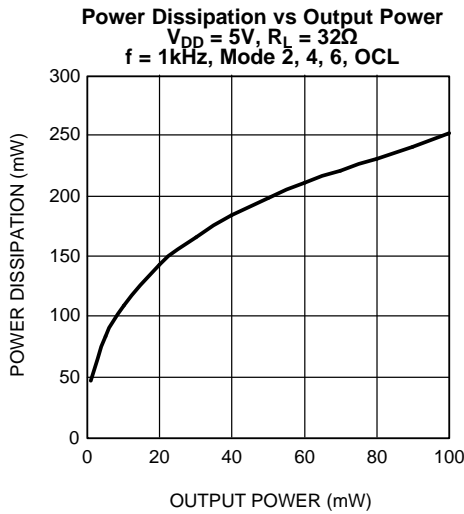

Figure 49.

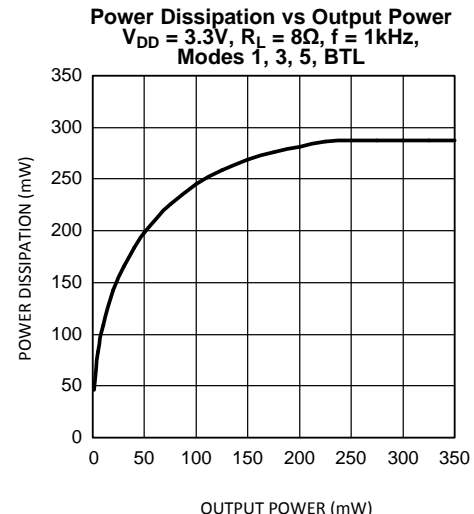

Figure 50.

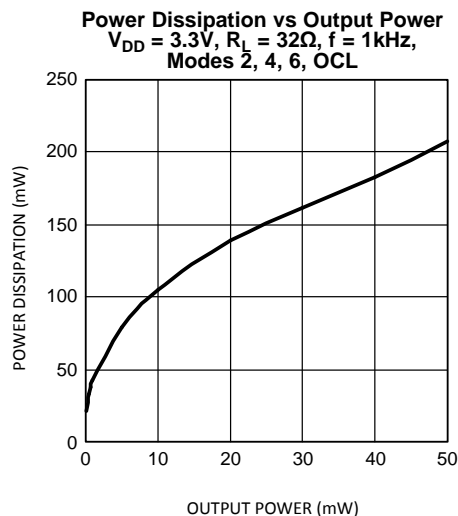

Figure 51.

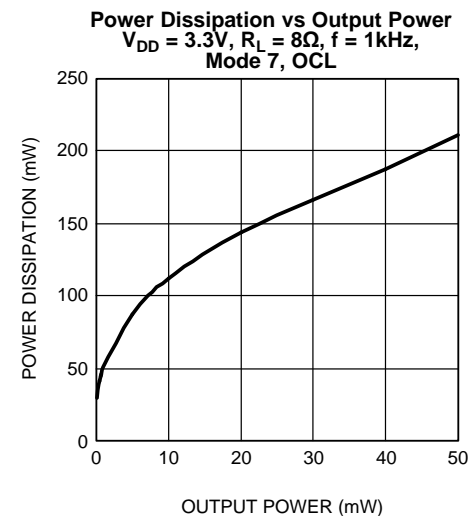

Figure 52.

Typical Performance Characteristics (continued)

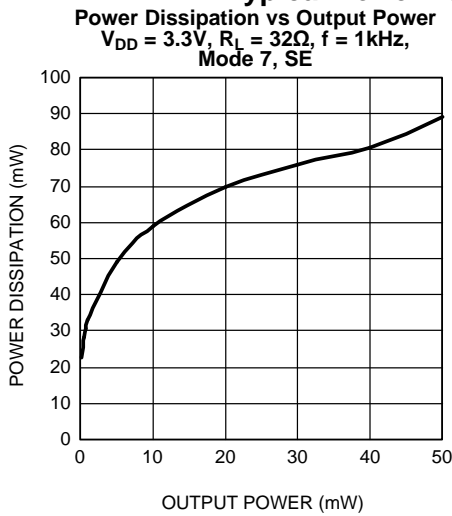

Figure 53.

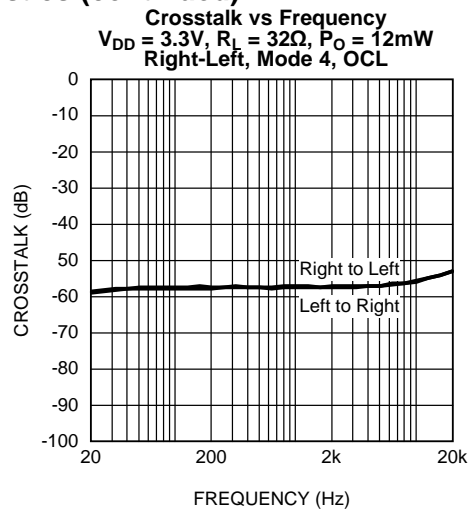

Figure 54.

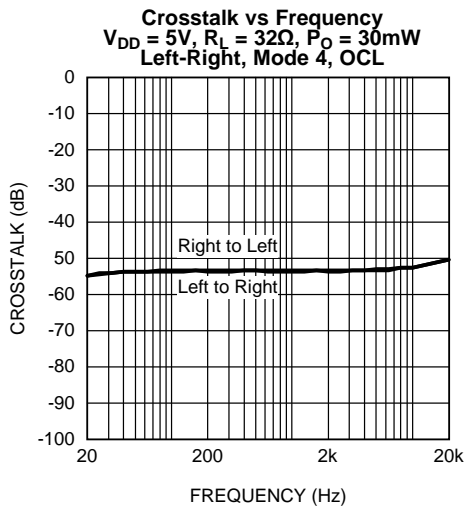

Figure 55.

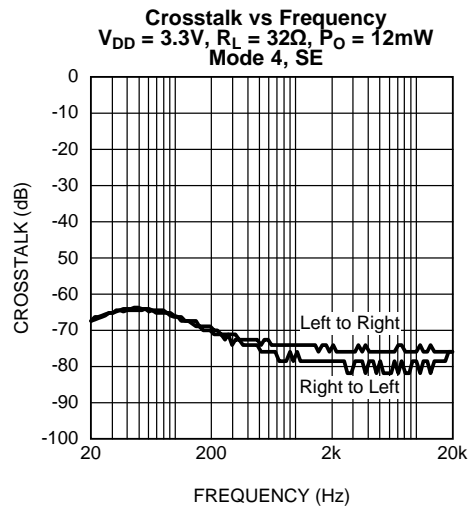

Figure 56.

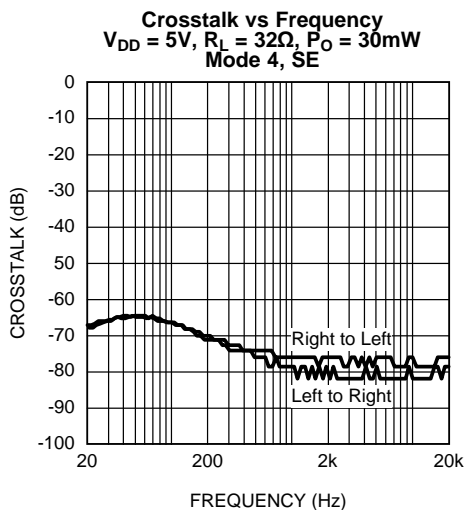

Figure 57.

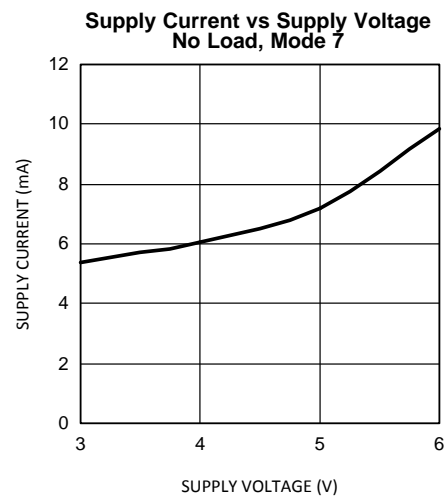

Figure 58.

**Typical Performance Characteristics (continued)**

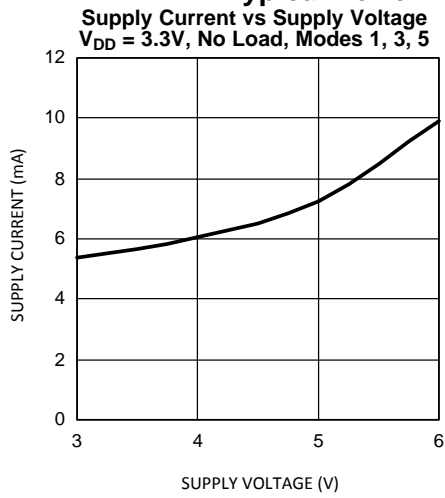

Figure 59.

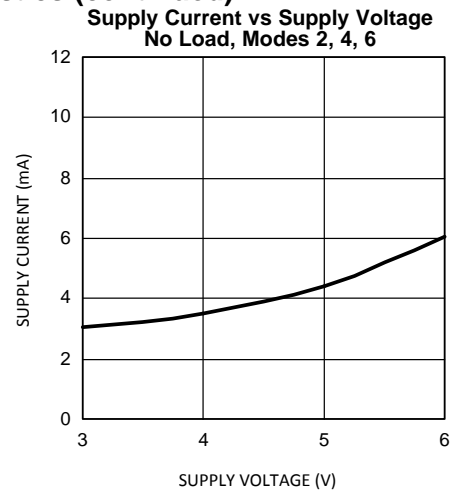

Figure 60.

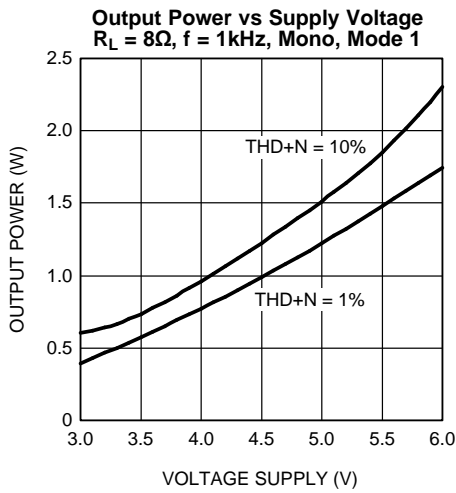

Figure 61.

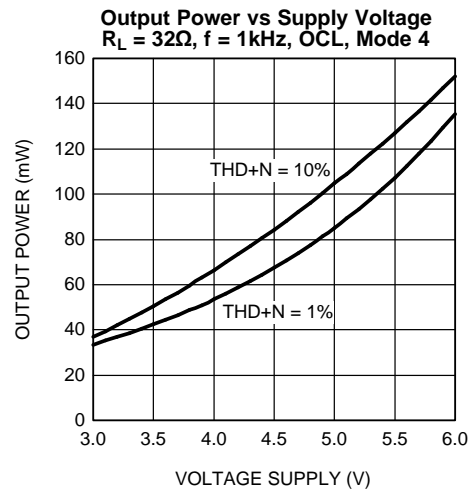

Figure 62.

## APPLICATION INFORMATION

### I<sup>2</sup>C PIN DESCRIPTION

SDA: This is the serial data input pin.

SCL: This is the clock input pin.

ID\_ENB: This is the address select input pin.

I<sup>2</sup>CSPI\_SEL: This is tied LOW for I<sup>2</sup>C mode.

### I<sup>2</sup>C COMPATIBLE INTERFACE

The LM4946 uses a serial bus which conforms to the I<sup>2</sup>C protocol to control the chip's functions with two wires: clock (SCL) and data (SDA). The clock line is uni-directional. The data line is bi-directional (open-collector). The maximum clock frequency specified by the I<sup>2</sup>C standard is 400kHz. In this discussion, the master is the controlling microcontroller and the slave is the LM4946.

The I<sup>2</sup>C address for the LM4946 is determined using the ID\_ENB pin. The LM4946's two possible I<sup>2</sup>C chip addresses are of the form 111110X<sub>1</sub>0 (binary), where X<sub>1</sub> = 0, if ID\_ENB is logic LOW; and X<sub>1</sub> = 1, if ID\_ENB is logic HIGH. If the I<sup>2</sup>C interface is used to address a number of chips in a system, the LM4946's chip address can be changed to avoid any possible address conflicts.

The bus format for the I<sup>2</sup>C interface is shown in [Figure 63](#). The bus format diagram is broken up into six major sections:

1. The "start" signal is generated by lowering the data signal while the clock signal is HIGH. The start signal will alert all devices attached to the I<sup>2</sup>C bus to check the incoming address against their own address.
2. The 8-bit chip address is sent next, most significant bit first. The data is latched in on the rising edge of the clock. Each address bit must be stable while the clock level is HIGH.

For I<sup>2</sup>C interface operation, the I<sup>2</sup>CSPI\_SEL pin needs to be tied LOW (and tied high for SPI operation).

3. After the last bit of the address bit is sent, the master releases the data line HIGH (through a pull-up resistor). Then the master sends an acknowledge clock pulse. If the LM4946 has received the address correctly, then it holds the data line LOW during the clock pulse. If the data line is not held LOW during the acknowledge clock pulse, then the master should abort the rest of the data transfer to the LM4946.
4. The 8 bits of data are sent next, most significant bit first. Each data bit should be valid while the clock level is stable HIGH.
5. After the data byte is sent, the master must check for another acknowledge to see if the LM4946 received the data.

If the master has more data bytes to send to the LM4946, then the master can repeat the previous two steps until all data bytes have been sent.

6. The "stop" signal ends the transfer. To signal "stop", the data signal goes HIGH while the clock signal is HIGH. The data line should be held HIGH when not in use.

### I<sup>2</sup>C INTERFACE POWER SUPPLY PIN (I<sup>2</sup>CSPI\_V<sub>DD</sub>)

The LM4946's I<sup>2</sup>C interface is powered up through the I<sup>2</sup>CSPI\_V<sub>DD</sub> pin. The LM4946's I<sup>2</sup>C interface operates at a voltage level set by the I<sup>2</sup>CV<sub>DD</sub> pin which can be set independent to that of the main power supply pin V<sub>DD</sub>. This is ideal whenever logic levels for the I<sup>2</sup>C interface are dictated by a microcontroller or microprocessor that is operating at a lower supply voltage than the main battery of a portable system.

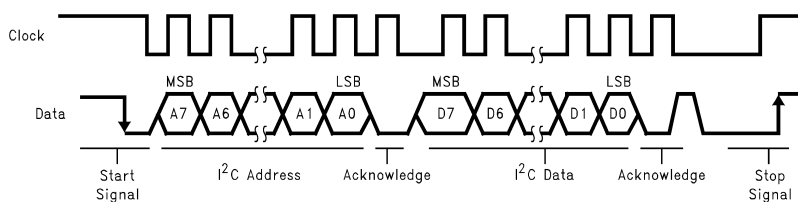
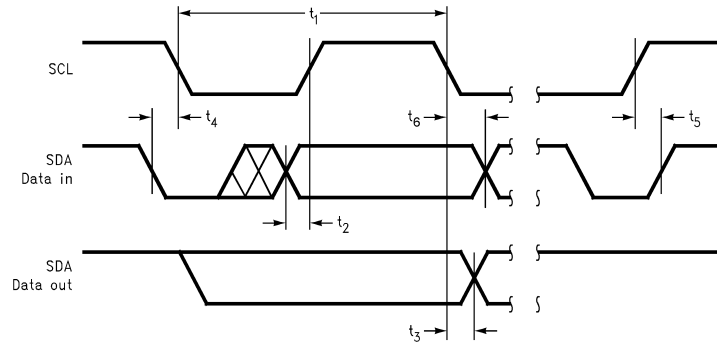

Figure 63. I<sup>2</sup>C Bus Format

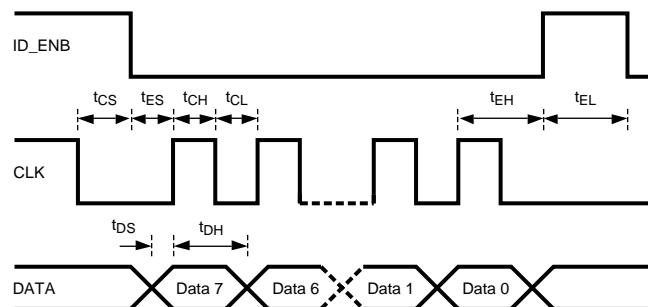

**Figure 64. I<sup>2</sup>C Timing Diagram**

## SPI DESCRIPTION

(For  $2.2V \leq I^2CSPI_{V_{DD}} \leq 5.5V$ , see [I2C/SPI WQFN/DSBGA](#) for more information).

0. I<sup>2</sup>CSPI\_SEL: This pin is tied HIGH for SPI mode.
1. The data bits are transmitted with the MSB first.
2. The maximum clock rate is 1MHz for the CLK pin.
3. CLK must remain HIGH for at least 500ns ( $t_{CH}$ ) after the rising edge of CLK, and CLK must remain LOW for at least 500ns ( $t_{CL}$ ) after the falling edge of CLK.
4. The serial data bits are sampled at the rising edge of CLK. Any transition on DATA must occur at least 100ns ( $t_{DS}$ ) before the rising edge of CLK. Also, any transition on DATA must occur at least 100ns ( $t_{DH}$ ) after the rising edge of CLK and stabilize before the next rising edge of CLK.
5. ID\_ENB should be LOW only during serial data transmission.
6. ID\_ENB must be LOW at least 100ns ( $t_{ES}$ ) before the first rising edge of CLK, and ID\_ENB has to remain LOW at least 100ns ( $t_{EH}$ ) after the eighth rising edge of CLK.
7. If ID\_ENB remains HIGH for more than 100ns before all 8 bits are transmitted then the data latch will be aborted.
8. If ID\_ENB is LOW for more than 8 CLK pulses then only the first 8 data bits will be latched and activated when ID\_ENB transitions to logic-high.
9. ID\_ENB must remain HIGH for at least 100ns ( $t_{EL}$ ) to latch in the data.
10. Coincidental rising or falling edges of CLK and ID\_ENB are not allowed. If CLK is to be held HIGH after the data transmission, the falling edge of CLK must occur at least 100ns ( $t_{CS}$ ) before ID\_ENB transitions to LOW for the next set of data.



**Figure 65. SPI Timing Diagram**

**Table 1. Chip Address**

	A7	A6	A5	A4	A3	A2	A1	A0
Chip Address	1	1	1	1	1	0	EC <sup>(1)</sup>	0
ID_ENB = 0	1	1	1	1	1	0	0	0
ID_ENB = 1	1	1	1	1	1	0	1	0

(1) EC — Externally Controlled

**Table 2. Control Registers<sup>(1)</sup>**

	D7	D6	D5	D4	D3	D2	D1	D0
Mode Control	0	0	0	0	OCL	MC2	MC1	MC0
Programmable 3D	0	1	0	0	N3D3	N3D2	N3D1	N3D0
Mono Volume Control	1	0	0	MVC4	MVC3	MVC2	MVC1	MVC0
Left Volume Control	1	1	0	LVC4	LVC3	LVC2	LVC1	LVC0
Right Volume Control	1	1	1	RVC4	RVC3	RVC2	RVC1	RVC0

- (1) Bits MVC0 — MVC4 control 32 step volume control for MONO input  
 Bits LVC0 — LVC4 control 32 step volume control for LEFT input  
 Bits RVC0 — RVC4 control 32 step volume control for RIGHT input  
 Bits MC0 — MC2 control 8 distinct modes  
 Bits N3D3, N3D2, N3D1, N3D0 control programmable 3D function  
 N3D0 turns the 3D function ON (N3D0 = 1) or OFF (N3D0 = 0), and N3D1 = 0 provides a “wider” aural effect or N3D1 = 1 a “narrower” aural effect  
 Bit OCL selects between SE with output capacitor (OCL = 0) or SE without output capacitors (OCL = 1). **Default is OCL = 0**

**Table 3. Programmable TI 3D Audio**

	N3D3	N3D2
Low	0	0
Medium	0	1
High	1	0
Maximum	1	1

**Table 4. Output Mode Selection<sup>(1)</sup>**

Output Mode Number	MC2	MC1	MC0	Handsfree Speaker Output	Right HP Output	Left HP Output
0	0	0	0	SD	SD	SD
1	0	0	1	$G_P \times P$	MUTE	MUTE
2	0	1	0	SD	$G_P \times P/2$	$G_P \times P/2$
3	0	1	1	$2 \times (G_L \times L + G_R \times R)$	MUTE	MUTE
4	1	0	0	SD	$G_R \times R$	$G_L \times L$
5	1	0	1	$2 \times (G_L \times L + G_R \times R) + G_P \times P$	MUTE	MUTE
6	1	1	0	SD	$G_R \times R + G_P \times P/2$	$G_L \times L + G_P \times P/2$
7	1	1	1	$2 \times (G_R \times R + G_L \times L)$	$G_R \times R$	$G_L \times L$

- (1) On initial POWER ON, the default mode is 000  
 P = Phone-in (Mono)  
 R =  $R_{IN}$   
 L =  $L_{IN}$   
 SD = Shutdown  
 MUTE = Mute Mode  
 $G_P$  = Phone In (Mono) volume control gain  
 $G_R$  = Right stereo volume control gain  
 $G_L$  = Left stereo volume control gain

**Table 5. Volume Control Table<sup>(1)</sup>**

Volume Step	xVC4	xVC3	xVC2	xVC1	xVC0	Gain, dB
1	0	0	0	0	0	-54.00
2	0	0	0	0	1	-46.50
3	0	0	0	1	0	-40.50
4	0	0	0	1	1	-34.50
5	0	0	1	0	0	-30.00
6	0	0	1	0	1	-27.00
7	0	0	1	1	0	-24.00
8	0	0	1	1	1	-21.00
9	0	1	0	0	0	-18.00
10	0	1	0	0	1	-15.00
11	0	1	0	1	0	-13.50
12	0	1	0	1	1	-12.00
13	0	1	1	0	0	-10.50
14	0	1	1	0	1	-9.00
15	0	1	1	1	0	-7.50
16	0	1	1	1	1	-6.00
17	1	0	0	0	0	-4.50
18	1	0	0	0	1	-3.00
19	1	0	0	1	0	-1.50
20	1	0	0	1	1	0.00
21	1	0	1	0	0	1.50
22	1	0	1	0	1	3.00
23	1	0	1	1	0	4.50
24	1	0	1	1	1	6.00
25	1	1	0	0	0	7.50
26	1	1	0	0	1	9.00
27	1	1	0	1	0	10.50
28	1	1	0	1	1	12.00
29	1	1	1	0	0	13.50
30	1	1	1	0	1	15.00
31	1	1	1	1	0	16.50
32	1	1	1	1	1	18.00

(1) x = M, L, or R  
Gain / Attenuation is from input to output

## TI 3D ENHANCEMENT

The LM4946 features a stereo headphone, 3D audio enhancement effect that widens the perceived soundstage from a stereo audio signal. The 3D audio enhancement creates a perceived spatial effect optimized for stereo headphone listening. The LM4946 can be programmed for a “narrow” or “wide” soundstage perception. The narrow soundstage has a more focused approaching sound direction, while the wide soundstage has a spatial, theater-like effect. Within each of these two modes, four discrete levels of 3D effect that can be programmed: low, medium, high, and maximum (Table 2, Table 3), each level with an ever increasing aural effect, respectively. The difference between each level is 3dB.

The external capacitors, shown in Figure 66, are required to enable the 3D effect. The value of the capacitors set the cutoff frequency of the 3D effect, as shown by Equation 1 and Equation 2. Note that the internal 20kΩ resistor is nominal.



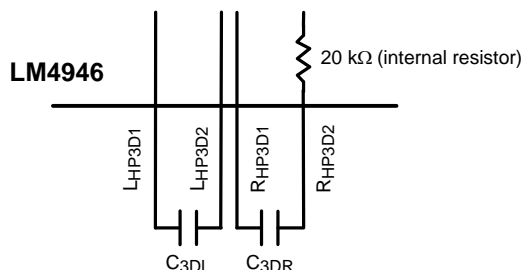

Figure 66. External 3D Effect Capacitors

$$f_{3DL(-3dB)} = 1 / 2\pi * 20k\Omega * C_{3DL} \tag{1}$$

$$f_{3DR(-3dB)} = 1 / 2\pi * 20k\Omega * C_{3DR} \tag{2}$$

Optional resistors  $R_{3DL}$  and  $R_{3DR}$  can also be added (Figure 67) to affect the -3dB frequency and 3D magnitude.

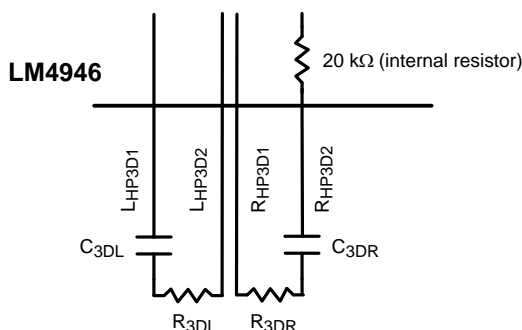

Figure 67. External RC Network with Optional  $R_{3DL}$  and  $R_{3DR}$  Resistors

$$f_{3DL(-3dB)} = 1 / 2\pi * (20k\Omega + R_{3DL}) * C_{3DL} \tag{3}$$

$$f_{3DR(-3dB)} = 1 / 2\pi * (20k\Omega + R_{3DR}) * C_{3DR} \tag{4}$$

$\Delta AV$  (change in AC gain) =  $1 / 1 + M$ , where M represents some ratio of the nominal internal resistor, 20kΩ (see example below).

$$f_{3dB (3D)} = 1 / 2\pi (1 + M)(20k\Omega * C_{3D}) \tag{5}$$

$$C_{Equivalent (new)} = C_{3D} / 1 + M \tag{6}$$

Table 6. Pole Locations

$R_{3D}$ (kΩ) (optional)	$C_{3D}$ (nF)	M	$\Delta AV$ (dB)	f-3dB (3D) (Hz)	Value of $C_{3D}$ to keep same pole location (nF)	new Pole Location (Hz)
0	68	0	0	117		
1	68	0.05	-0.4	111	64.8	117
5	68	0.25	-1.9	94	54.4	117
10	68	0.50	-3.5	78	45.3	117
20	68	1.00	-6.0	59	34.0	117

## PCB LAYOUT AND SUPPLY REGULATION CONSIDERATIONS FOR DRIVING 8Ω LOAD

Power dissipated by a load is a function of the voltage swing across the load and the load's impedance. As load impedance decreases, load dissipation becomes increasingly dependent on the interconnect (PCB trace and wire) resistance between the amplifier output pins and the load's connections. Residual trace resistance causes a voltage drop, which results in power dissipated in the trace and not in the load as desired. For example, 0.1Ω trace resistance reduces the output power dissipated by an 8Ω load from 158.3mW to 156.4mW. The problem of decreased load dissipation is exacerbated as load impedance decreases. Therefore, to maintain the highest load dissipation and widest output voltage swing, PCB traces that connect the output pins to a load must be as wide as possible.

Poor power supply regulation adversely affects maximum output power. A poorly regulated supply's output voltage decreases with increasing load current. Reduced supply voltage causes decreased headroom, output signal clipping, and reduced output power. Even with tightly regulated supplies, trace resistance creates the same effects as poor supply regulation. Therefore, making the power supply traces as wide as possible helps maintain full output voltage swing.

## BRIDGE CONFIGURATION EXPLANATION

The LM4946 drives a load, such as a speaker, connected between outputs, MONO+ and MONO-.

This results in both amplifiers producing signals identical in magnitude, but 180° out of phase. Taking advantage of this phase difference, a load is placed between MONO- and MONO+ and driven differentially (commonly referred to as "bridge mode"). This results in a differential or BTL gain of:

$$A_{VD} = 2(R_f / R_i) = 2 \quad (7)$$

Bridge mode amplifiers are different from single-ended amplifiers that drive loads connected between a single amplifier's output and ground. For a given supply voltage, bridge mode has a distinct advantage over the single-ended configuration: its differential output doubles the voltage swing across the load. Theoretically, this produces four times the output power when compared to a single-ended amplifier under the same conditions. This increase in attainable output power assumes that the amplifier is not current limited and that the output signal is not clipped.

Another advantage of the differential bridge output is no net DC voltage across the load. This is accomplished by biasing MONO- and MONO+ outputs at half-supply. This eliminates the coupling capacitor that single supply, single-ended amplifiers require. Eliminating an output coupling capacitor in a typical single-ended configuration forces a single-supply amplifier's half-supply bias voltage across the load. This increases internal IC power dissipation and may permanently damage loads such as speakers.

## POWER DISSIPATION

Power dissipation is a major concern when designing a successful single-ended or bridged amplifier.

A direct consequence of the increased power delivered to the load by a bridge amplifier is higher internal power dissipation. The LM4946 has a pair of bridged-tied amplifiers driving a handsfree speaker, MONO. The maximum internal power dissipation operating in the bridge mode is twice that of a single-ended amplifier. From [Equation 8](#), assuming a 5V power supply and an 8Ω load, the maximum MONO power dissipation is 634mW.

$$P_{DMAX-SPKROUT} = 4(V_{DD})^2 / (2\pi^2 R_L): \text{ Bridge Mode} \quad (8)$$

The LM4946 also has a pair of single-ended amplifiers driving stereo headphones, R<sub>OUT</sub> and L<sub>OUT</sub>. The maximum internal power dissipation for R<sub>OUT</sub> and L<sub>OUT</sub> is given by [Equation 9](#) and [Equation 10](#). From [Equation 9](#) and [Equation 10](#), assuming a 5V power supply and a 32Ω load, the maximum power dissipation for L<sub>OUT</sub> and R<sub>OUT</sub> is 40mW, or 80mW total.

$$P_{DMAX-LOUT} = (V_{DD})^2 / (2\pi^2 R_L): \text{ Single-ended Mode} \quad (9)$$

$$P_{DMAX-ROUT} = (V_{DD})^2 / (2\pi^2 R_L): \text{ Single-ended Mode} \quad (10)$$

The maximum internal power dissipation of the LM4946 occurs when all three amplifiers pairs are simultaneously on; and is given by [Equation 11](#).

$$P_{DMAX-TOTAL} = P_{DMAX-SPKROUT} + P_{DMAX-LOUT} + P_{DMAX-ROUT} \quad (11)$$

The maximum power dissipation point given by [Equation 11](#) must not exceed the power dissipation given by [Equation 12](#):

$$P_{\text{DMAX}} = (T_{\text{JMAX}} - T_{\text{A}}) / \theta_{\text{JA}} \quad (12)$$

The LM4946's  $T_{\text{JMAX}} = 150^{\circ}\text{C}$ . In the SQ package, the LM4946's  $\theta_{\text{JA}}$  is  $46^{\circ}\text{C/W}$ . At any given ambient temperature  $T_{\text{A}}$ , use [Equation 12](#) to find the maximum internal power dissipation supported by the IC packaging. Rearranging [Equation 12](#) and substituting  $P_{\text{DMAX-TOTAL}}$  for  $P_{\text{DMAX}}$  results in [Equation 13](#). This equation gives the maximum ambient temperature that still allows maximum stereo power dissipation without violating the LM4946's maximum junction temperature.

$$T_{\text{A}} = T_{\text{JMAX}} - P_{\text{DMAX-TOTAL}} \theta_{\text{JA}} \quad (13)$$

For a typical application with a 5V power supply and an  $8\Omega$  load, the maximum ambient temperature that allows maximum mono power dissipation without exceeding the maximum junction temperature is approximately  $121^{\circ}\text{C}$  for the SQ package.

$$T_{\text{JMAX}} = P_{\text{DMAX-TOTAL}} \theta_{\text{JA}} + T_{\text{A}} \quad (14)$$

[Equation 14](#) gives the maximum junction temperature  $T_{\text{JMAX}}$ . If the result violates the LM4946's  $150^{\circ}\text{C}$ , reduce the maximum junction temperature by reducing the power supply voltage or increasing the load resistance. Further allowance should be made for increased ambient temperatures.

The above examples assume that a device is a surface mount part operating around the maximum power dissipation point. Since internal power dissipation is a function of output power, higher ambient temperatures are allowed as output power or duty cycle decreases. If the result of [Equation 11](#) is greater than that of [Equation 12](#), then decrease the supply voltage, increase the load impedance, or reduce the ambient temperature. If these measures are insufficient, a heat sink can be added to reduce  $\theta_{\text{JA}}$ . The heat sink can be created using additional copper area around the package, with connections to the ground pin(s), supply pin and amplifier output pins. External, solder attached SMT heatsinks such as the Thermalloy 7106D can also improve power dissipation. When adding a heat sink, the  $\theta_{\text{JA}}$  is the sum of  $\theta_{\text{JC}}$ ,  $\theta_{\text{CS}}$ , and  $\theta_{\text{SA}}$ . ( $\theta_{\text{JC}}$  is the junction-to-case thermal impedance,  $\theta_{\text{CS}}$  is the case-to-sink thermal impedance, and  $\theta_{\text{SA}}$  is the sink-to-ambient thermal impedance). Refer to the [Typical Performance Characteristics](#) curves for power dissipation information at lower output power levels.

## POWER SUPPLY BYPASSING

As with any power amplifier, proper supply bypassing is critical for low noise performance and high power supply rejection. Applications that employ a 5V regulator typically use a  $1\mu\text{F}$  in parallel with a  $0.1\mu\text{F}$  filter capacitors to stabilize the regulator's output, reduce noise on the supply line, and improve the supply's transient response. However, their presence does not eliminate the need for a local  $1.0\mu\text{F}$  tantalum bypass capacitor and a parallel  $0.1\mu\text{F}$  ceramic capacitor connected between the LM4946's supply pin and ground. Keep the length of leads and traces that connect capacitors between the LM4946's power supply pin and ground as short as possible.

## SELECTING EXTERNAL COMPONENTS

### Input Capacitor Value Selection

Amplifying the lowest audio frequencies requires high value input coupling capacitor ( $C_{\text{i}}$  in [Figure 1](#) & [Figure 2](#)). A high value capacitor can be expensive and may compromise space efficiency in portable designs. In many cases, however, the speakers used in portable systems, whether internal or external, have little ability to reproduce signals below 150Hz. Applications using speakers with this limited frequency response reap little improvement by using large input capacitor.

The internal input resistor ( $R_{\text{i}}$ ), minimum  $10\text{k}\Omega$ , and the input capacitor ( $C_{\text{i}}$ ) produce a high pass filter cutoff frequency that is found using [Equation 15](#).

$$f_{\text{c}} = 1 / (2\pi R_{\text{i}} C_{\text{i}}) \quad (15)$$

As an example when using a speaker with a low frequency limit of 150Hz,  $C_{\text{i}}$ , using [Equation 15](#) is  $0.106\mu\text{F}$ . The  $0.22\mu\text{F}$   $C_{\text{i}}$  shown in [Figure 1](#) allows the LM4946 to drive high efficiency, full range speaker whose response extends below 40Hz.

### Bypass Capacitor Value Selection

Besides minimizing the input capacitor size, careful consideration should be paid to value of  $C_B$ , the capacitor connected to the BYPASS pin. Since  $C_B$  determines how fast the LM4946 settles to quiescent operation, its value is critical when minimizing turn-on pops. The slower the LM4946's outputs ramp to their quiescent DC voltage (nominally  $V_{DD}/2$ ), the smaller the turn-on pop. Choosing  $C_B$  equal to 2.2 $\mu$ F along with a small value of  $C_i$  (in the range of 0.1 $\mu$ F to 0.33 $\mu$ F), produces a click-less and pop-less shutdown function. As discussed above, choosing  $C_i$  no larger than necessary for the desired bandwidth helps minimize clicks and pops.  $C_B$ 's value should be in the range of 7 to 10 times the value of  $C_i$ . This ensures that output transients are eliminated when power is first applied or the LM4946 resumes operation after shutdown.

Demo Board Schematic Diagram

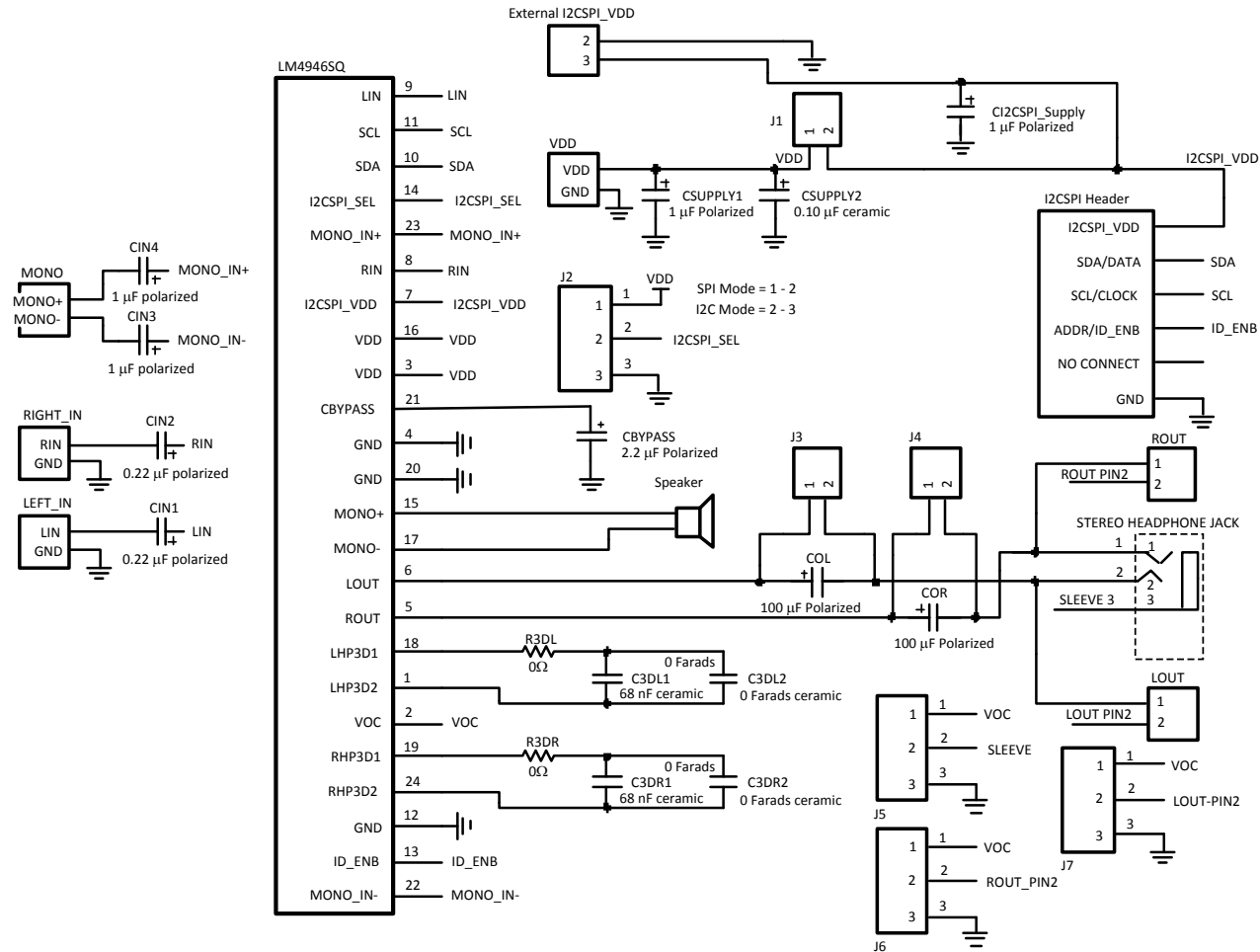

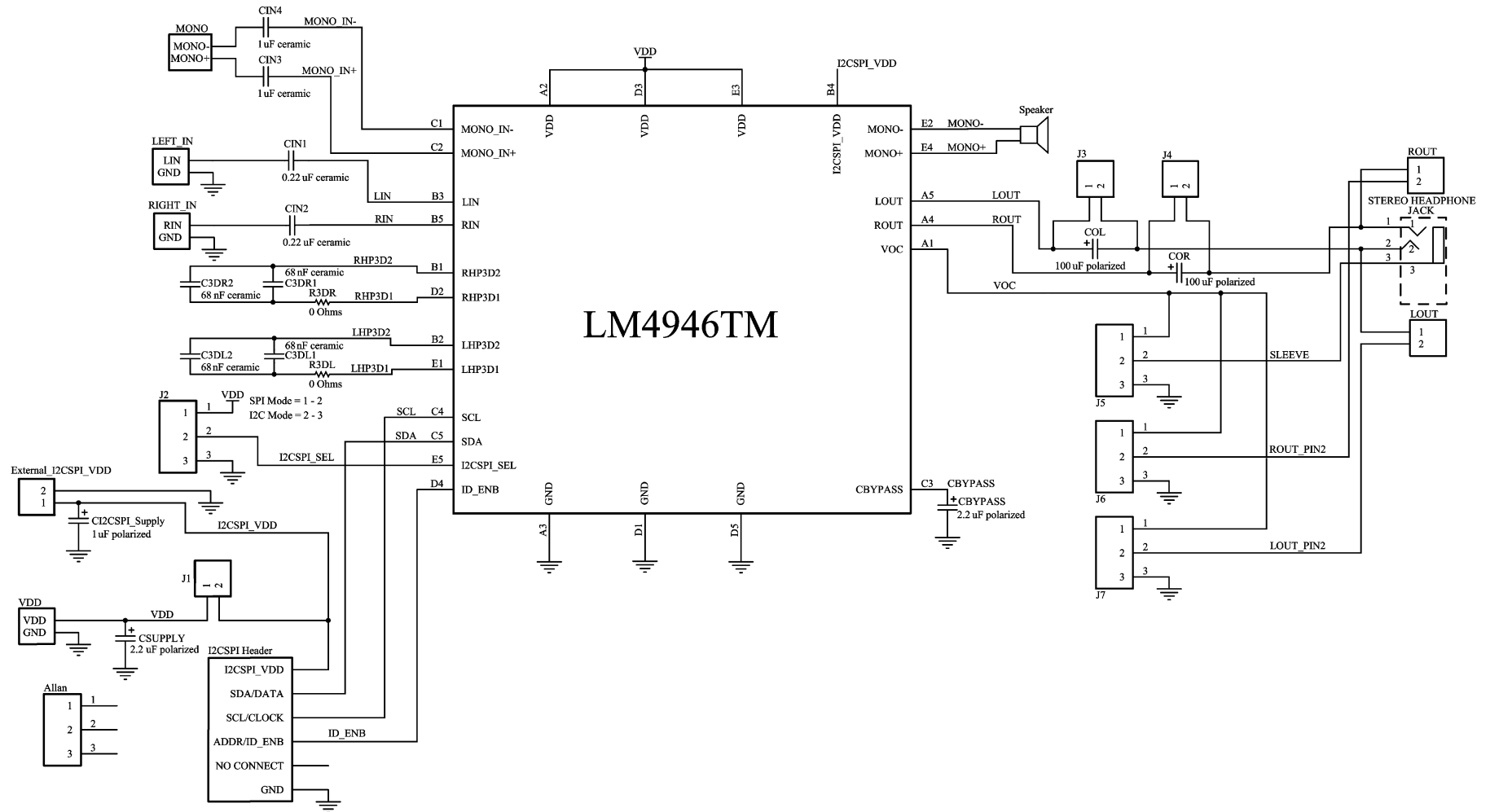

## REVISION HISTORY

Rev	Date	Description
1.0	01/23/06	Initial release.
1.1	03/05/07	Added the YFQ0025XXX package.
1.2	03/13/07	Edited the 25-pin DSBGA connection diagram.
1.3	04/24/07	Added the I2C/SPI (1.7V 2.2V ) table.
1.4	04/26/07	Added the numerical values for the X1, X2, and X3 in the Physical Dimension section.
1.5	05/02/07	Text edits. Added the YFQ package.
1.6	05/15/07	Added the TM board schematic and input some text edits.
1.7	05/16/07	More text edits.
1.8	06/06/07	Added Note 11 and more text edits.
1.9	07/31/07	Edited the 5.0V EC table (MONO_IN Input Impedance and Rin/Lin Input Impedance).

**PACKAGING INFORMATION**

Orderable Device	Status (1)	Package Type	Package Drawing	Pins	Package Qty	Eco Plan (2)	Lead/Ball Finish	MSL Peak Temp (3)	Op Temp (°C)	Top-Side Markings (4)	Samples
LM4946SQ/NOPB	ACTIVE	WQFN	RTW	24	1000	Green (RoHS & no Sb/Br)	CU SN	Level-1-260C-UNLIM	-40 to 85	L4946SQ	<a href="#">Samples</a>
LM4946SQX/NOPB	ACTIVE	WQFN	RTW	24	4500	Green (RoHS & no Sb/Br)	CU SN	Level-1-260C-UNLIM	-40 to 85	L4946SQ	<a href="#">Samples</a>
LM4946TM/NOPB	ACTIVE	DSBGA	YFQ	25	250	Green (RoHS & no Sb/Br)	SNAGCU	Level-1-260C-UNLIM	-40 to 85	GI9	<a href="#">Samples</a>
LM4946TMX/NOPB	ACTIVE	DSBGA	YFQ	25	3000	Green (RoHS & no Sb/Br)	SNAGCU	Level-1-260C-UNLIM	-40 to 85	GI9	<a href="#">Samples</a>

(1) The marketing status values are defined as follows:

**ACTIVE:** Product device recommended for new designs.

**LIFEBUY:** TI has announced that the device will be discontinued, and a lifetime-buy period is in effect.

**NRND:** Not recommended for new designs. Device is in production to support existing customers, but TI does not recommend using this part in a new design.

**PREVIEW:** Device has been announced but is not in production. Samples may or may not be available.

**OBSELETE:** TI has discontinued the production of the device.

(2) Eco Plan - The planned eco-friendly classification: Pb-Free (RoHS), Pb-Free (RoHS Exempt), or Green (RoHS & no Sb/Br) - please check <http://www.ti.com/productcontent> for the latest availability information and additional product content details.

**TBD:** The Pb-Free/Green conversion plan has not been defined.

**Pb-Free (RoHS):** TI's terms "Lead-Free" or "Pb-Free" mean semiconductor products that are compatible with the current RoHS requirements for all 6 substances, including the requirement that lead not exceed 0.1% by weight in homogeneous materials. Where designed to be soldered at high temperatures, TI Pb-Free products are suitable for use in specified lead-free processes.

**Pb-Free (RoHS Exempt):** This component has a RoHS exemption for either 1) lead-based flip-chip solder bumps used between the die and package, or 2) lead-based die adhesive used between the die and leadframe. The component is otherwise considered Pb-Free (RoHS compatible) as defined above.

**Green (RoHS & no Sb/Br):** TI defines "Green" to mean Pb-Free (RoHS compatible), and free of Bromine (Br) and Antimony (Sb) based flame retardants (Br or Sb do not exceed 0.1% by weight in homogeneous material)

(3) MSL, Peak Temp. -- The Moisture Sensitivity Level rating according to the JEDEC industry standard classifications, and peak solder temperature.

(4) Multiple Top-Side Markings will be inside parentheses. Only one Top-Side Marking contained in parentheses and separated by a "~" will appear on a device. If a line is indented then it is a continuation of the previous line and the two combined represent the entire Top-Side Marking for that device.

**Important Information and Disclaimer:** The information provided on this page represents TI's knowledge and belief as of the date that it is provided. TI bases its knowledge and belief on information provided by third parties, and makes no representation or warranty as to the accuracy of such information. Efforts are underway to better integrate information from third parties. TI has taken and continues to take reasonable steps to provide representative and accurate information but may not have conducted destructive testing or chemical analysis on incoming materials and chemicals. TI and TI suppliers consider certain information to be proprietary, and thus CAS numbers and other limited information may not be available for release.

In no event shall TI's liability arising out of such information exceed the total purchase price of the TI part(s) at issue in this document sold by TI to Customer on an annual basis.





**TAPE AND REEL INFORMATION**

**QUADRANT ASSIGNMENTS FOR PIN 1 ORIENTATION IN TAPE**

\*All dimensions are nominal

Device	Package Type	Package Drawing	Pins	SPQ	Reel Diameter (mm)	Reel Width W1 (mm)	A0 (mm)	B0 (mm)	K0 (mm)	P1 (mm)	W (mm)	Pin1 Quadrant
LM4946SQ/NOPB	WQFN	RTW	24	1000	178.0	12.4	4.3	4.3	1.3	8.0	12.0	Q1
LM4946SQX/NOPB	WQFN	RTW	24	4500	330.0	12.4	4.3	4.3	1.3	8.0	12.0	Q1
LM4946TM/NOPB	DSBGA	YFQ	25	250	178.0	8.4	2.18	2.18	0.76	4.0	8.0	Q1
LM4946TMX/NOPB	DSBGA	YFQ	25	3000	178.0	8.4	2.18	2.18	0.76	4.0	8.0	Q1

## TAPE AND REEL BOX DIMENSIONS



\*All dimensions are nominal

Device	Package Type	Package Drawing	Pins	SPQ	Length (mm)	Width (mm)	Height (mm)
LM4946SQ/NOPB	WQFN	RTW	24	1000	203.0	190.0	41.0
LM4946SQX/NOPB	WQFN	RTW	24	4500	367.0	367.0	35.0
LM4946TM/NOPB	DSBGA	YFQ	25	250	210.0	185.0	35.0
LM4946TMX/NOPB	DSBGA	YFQ	25	3000	210.0	185.0	35.0

RTW0024A

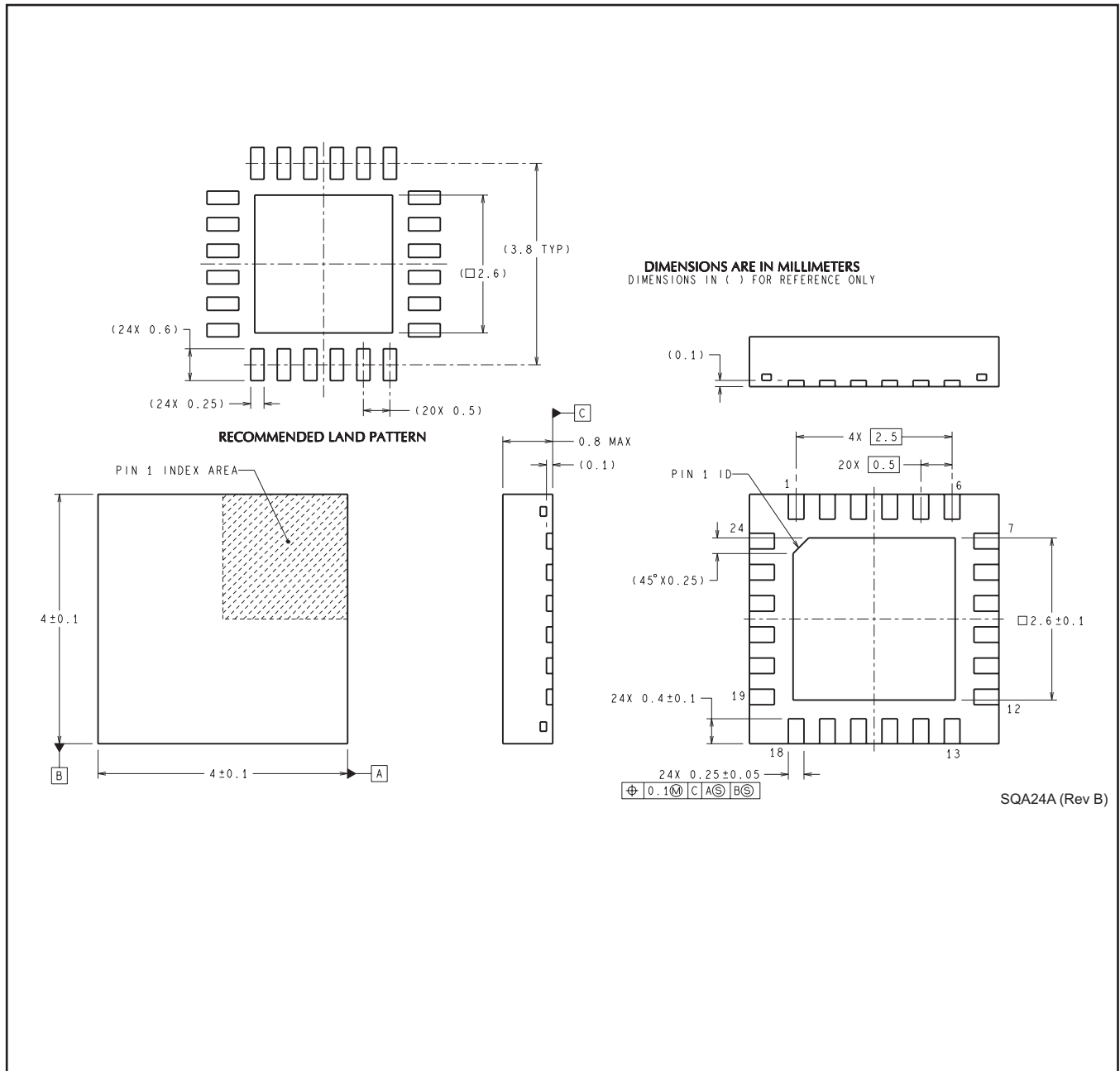

YFQ0025

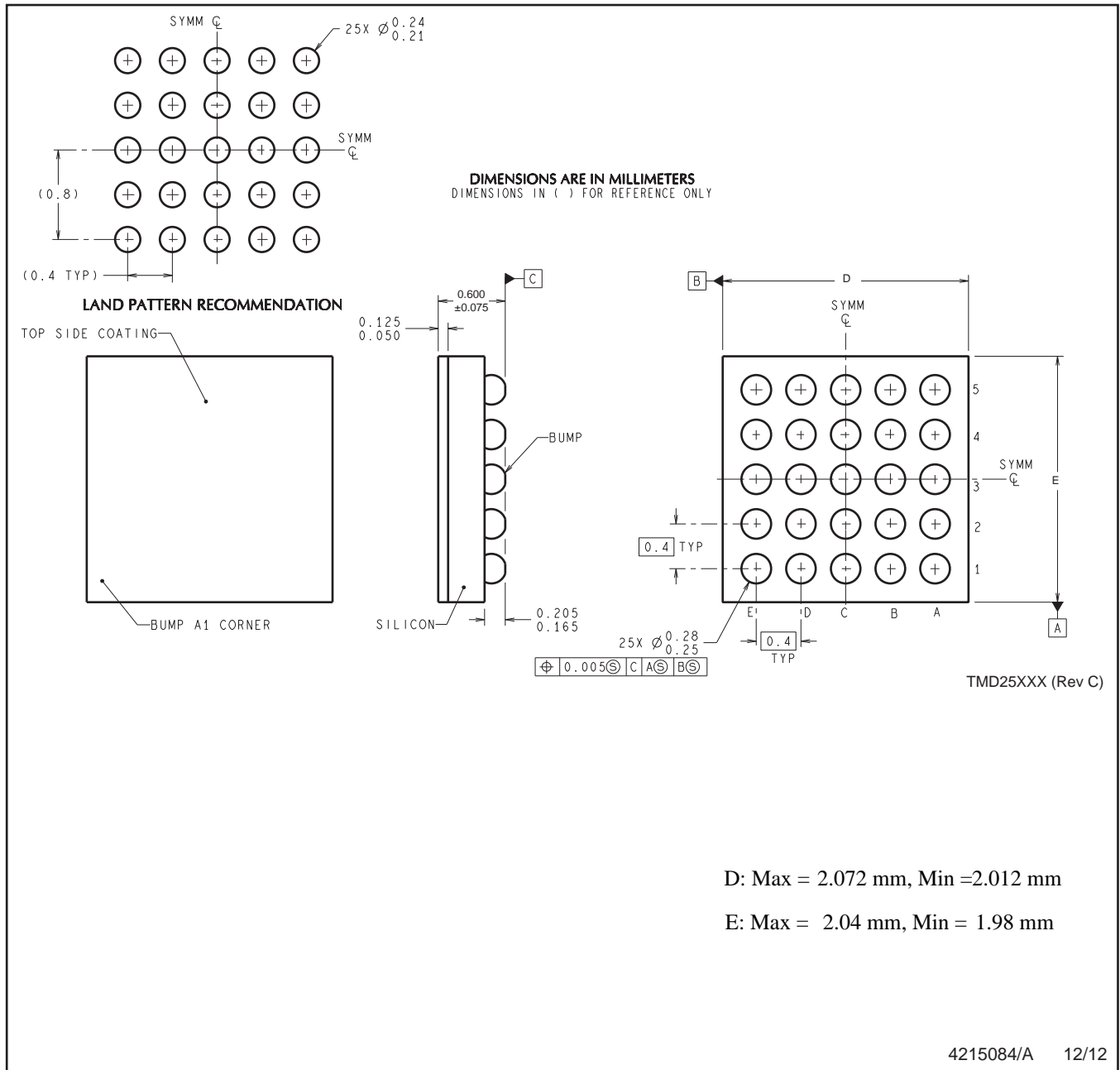

NOTES: A. All linear dimensions are in millimeters. Dimensioning and tolerancing per ASME Y14.5M-1994.  
B. This drawing is subject to change without notice.

## IMPORTANT NOTICE

Texas Instruments Incorporated and its subsidiaries (TI) reserve the right to make corrections, enhancements, improvements and other changes to its semiconductor products and services per JESD46, latest issue, and to discontinue any product or service per JESD48, latest issue. Buyers should obtain the latest relevant information before placing orders and should verify that such information is current and complete. All semiconductor products (also referred to herein as "components") are sold subject to TI's terms and conditions of sale supplied at the time of order acknowledgment.

TI warrants performance of its components to the specifications applicable at the time of sale, in accordance with the warranty in TI's terms and conditions of sale of semiconductor products. Testing and other quality control techniques are used to the extent TI deems necessary to support this warranty. Except where mandated by applicable law, testing of all parameters of each component is not necessarily performed.

TI assumes no liability for applications assistance or the design of Buyers' products. Buyers are responsible for their products and applications using TI components. To minimize the risks associated with Buyers' products and applications, Buyers should provide adequate design and operating safeguards.

TI does not warrant or represent that any license, either express or implied, is granted under any patent right, copyright, mask work right, or other intellectual property right relating to any combination, machine, or process in which TI components or services are used. Information published by TI regarding third-party products or services does not constitute a license to use such products or services or a warranty or endorsement thereof. Use of such information may require a license from a third party under the patents or other intellectual property of the third party, or a license from TI under the patents or other intellectual property of TI.

Reproduction of significant portions of TI information in TI data books or data sheets is permissible only if reproduction is without alteration and is accompanied by all associated warranties, conditions, limitations, and notices. TI is not responsible or liable for such altered documentation. Information of third parties may be subject to additional restrictions.

Resale of TI components or services with statements different from or beyond the parameters stated by TI for that component or service voids all express and any implied warranties for the associated TI component or service and is an unfair and deceptive business practice. TI is not responsible or liable for any such statements.

Buyer acknowledges and agrees that it is solely responsible for compliance with all legal, regulatory and safety-related requirements concerning its products, and any use of TI components in its applications, notwithstanding any applications-related information or support that may be provided by TI. Buyer represents and agrees that it has all the necessary expertise to create and implement safeguards which anticipate dangerous consequences of failures, monitor failures and their consequences, lessen the likelihood of failures that might cause harm and take appropriate remedial actions. Buyer will fully indemnify TI and its representatives against any damages arising out of the use of any TI components in safety-critical applications.

In some cases, TI components may be promoted specifically to facilitate safety-related applications. With such components, TI's goal is to help enable customers to design and create their own end-product solutions that meet applicable functional safety standards and requirements. Nonetheless, such components are subject to these terms.

No TI components are authorized for use in FDA Class III (or similar life-critical medical equipment) unless authorized officers of the parties have executed a special agreement specifically governing such use.

Only those TI components which TI has specifically designated as military grade or "enhanced plastic" are designed and intended for use in military/aerospace applications or environments. Buyer acknowledges and agrees that any military or aerospace use of TI components which have **not** been so designated is solely at the Buyer's risk, and that Buyer is solely responsible for compliance with all legal and regulatory requirements in connection with such use.

TI has specifically designated certain components as meeting ISO/TS16949 requirements, mainly for automotive use. In any case of use of non-designated products, TI will not be responsible for any failure to meet ISO/TS16949.

### Products

Audio	<a href="http://www.ti.com/audio">www.ti.com/audio</a>
Amplifiers	<a href="http://amplifier.ti.com">amplifier.ti.com</a>
Data Converters	<a href="http://dataconverter.ti.com">dataconverter.ti.com</a>
DLP® Products	<a href="http://www.dlp.com">www.dlp.com</a>
DSP	<a href="http://dsp.ti.com">dsp.ti.com</a>
Clocks and Timers	<a href="http://www.ti.com/clocks">www.ti.com/clocks</a>
Interface	<a href="http://interface.ti.com">interface.ti.com</a>
Logic	<a href="http://logic.ti.com">logic.ti.com</a>
Power Mgmt	<a href="http://power.ti.com">power.ti.com</a>
Microcontrollers	<a href="http://microcontroller.ti.com">microcontroller.ti.com</a>
RFID	<a href="http://www.ti-rfid.com">www.ti-rfid.com</a>
OMAP Applications Processors	<a href="http://www.ti.com/omap">www.ti.com/omap</a>
Wireless Connectivity	<a href="http://www.ti.com/wirelessconnectivity">www.ti.com/wirelessconnectivity</a>

### Applications

Automotive and Transportation	<a href="http://www.ti.com/automotive">www.ti.com/automotive</a>
Communications and Telecom	<a href="http://www.ti.com/communications">www.ti.com/communications</a>
Computers and Peripherals	<a href="http://www.ti.com/computers">www.ti.com/computers</a>
Consumer Electronics	<a href="http://www.ti.com/consumer-apps">www.ti.com/consumer-apps</a>
Energy and Lighting	<a href="http://www.ti.com/energy">www.ti.com/energy</a>
Industrial	<a href="http://www.ti.com/industrial">www.ti.com/industrial</a>
Medical	<a href="http://www.ti.com/medical">www.ti.com/medical</a>
Security	<a href="http://www.ti.com/security">www.ti.com/security</a>
Space, Avionics and Defense	<a href="http://www.ti.com/space-avionics-defense">www.ti.com/space-avionics-defense</a>
Video and Imaging	<a href="http://www.ti.com/video">www.ti.com/video</a>

### TI E2E Community

[e2e.ti.com](http://e2e.ti.com)