

LM4920 Boomer[®] Audio Power Amplifier Series **Ground-Referenced, Ultra Low Noise, Fixed Gain, 80mW Stereo Headphone Amplifier**

Check for Samples: [LM4920](#)

FEATURES

- **Fixed Logic Levels**
- **Ground Referenced Outputs**
- **High PSRR**
- **Available in Space-Saving DSBGA Package**
- **Ultra Low Current Shutdown Mode**
- **Improved Pop & Click Circuitry Eliminates Noises During Turn-On and Turn-Off Transitions**
- **No Output Coupling Capacitors, Snubber Networks, Bootstrap Capacitors, or Gain-Setting Resistors Required**
- **Shutdown Either Channel Independently**

APPLICATIONS

- **Mobile Phones**
- **MP3 Players**
- **PDA's**
- **Portable electronic devices**
- **Notebook PCs**

KEY SPECIFICATIONS

- **Improved PSRR at 217Hz: 70dB (typ)**
- **Power Output at VDD = 3V, RL = 16Ω, THD % 1%: 80mW (typ)**
- **Shutdown Current: 0.01μA (typ)**
- **Internal Fixed Gain: 1.5V/V (typ)**
- **Operating Voltage: 1.6V to 4.2V**

DESCRIPTION

The LM4920 is a ground referenced, fixed-gain audio power amplifier capable of delivering 80mW of continuous average power into a 16Ω single-ended load with less than 1% THD+N from a 3V power supply.

The LM4920 features a new circuit technology that utilizes a charge pump to generate a negative reference voltage. This allows the outputs to be biased about ground, thereby eliminating output-coupling capacitors typically used with normal single-ended loads.

Boomer audio power amplifiers were designed specifically to provide high quality output power with a minimal amount of external components. The LM4920 does not require output coupling capacitors or bootstrap capacitors, and therefore is ideally suited for mobile phone and other low voltage applications where minimal power consumption is a primary requirement.

The LM4920 features a low-power consumption shutdown mode selectable for either channel separately. This is accomplished by driving either the SD_RC (Shutdown Right Channel) or SD_LC (Shutdown Left Channel) (or both) pins with logic low, depending on which channel is desired shutdown. Additionally, the LM4920 features an internal thermal shutdown protection mechanism.

The LM4920 contains advanced pop & click circuitry that eliminates noises which would otherwise occur during turn-on and turn-off transitions.

The LM4920 has an internal fixed gain of 1.5V/V.



Please be aware that an important notice concerning availability, standard warranty, and use in critical applications of Texas Instruments semiconductor products and disclaimers thereto appears at the end of this data sheet.

All trademarks are the property of their respective owners.

Typical Application

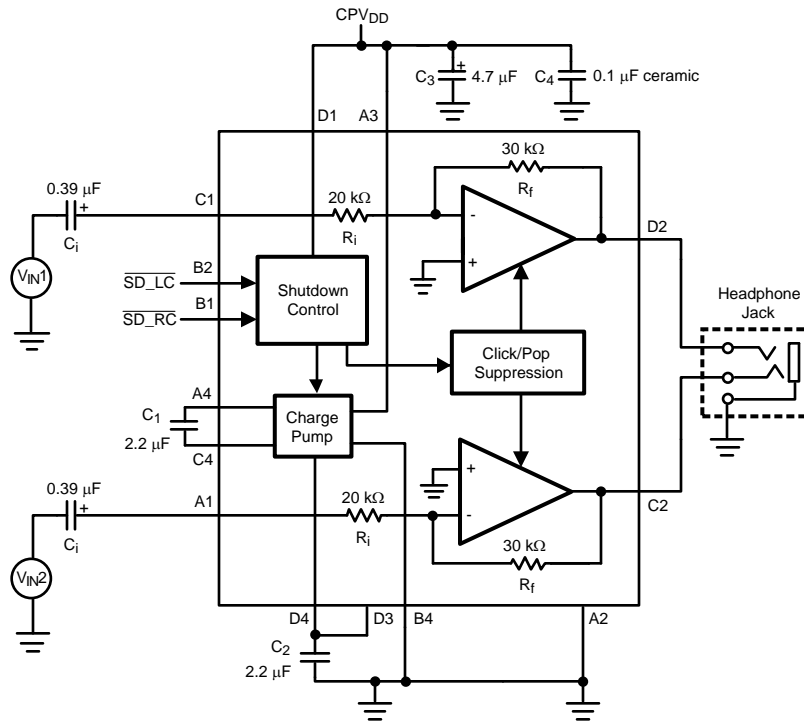

Figure 1. Typical Audio Amplifier Application Circuit

Connection Diagram

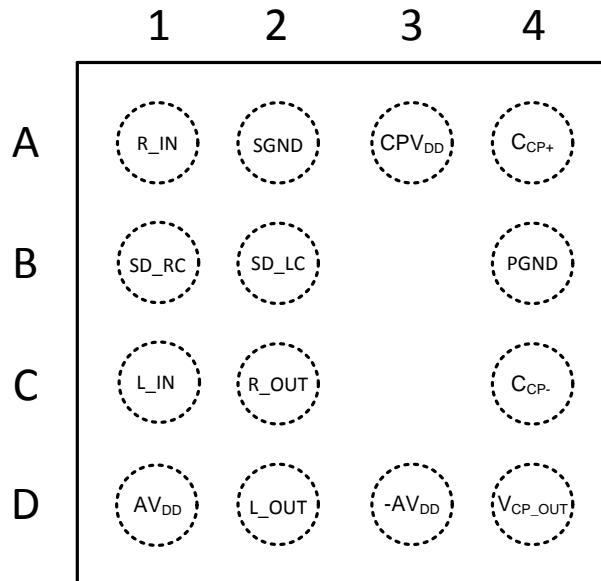

Figure 2. Top View
DSBGA
See YZE0014 Package

PIN DESCRIPTIONS

Pin	Name	Function
A1	R_IN	Right Channel Input
A2	SGND	Signal Ground
A3	CPV _{DD}	Charge Pump Power Supply
A4	C _{CP+}	Positive Terminal - Charge Pump Flying Capacitor
B1	SD_RC	Active-Low Shutdown, Right Channel
B2	SD_LC	Active-Low Shutdown, Left Channel
B4	PGND	Power Ground
C1	L_IN	Left Channel Input
C2	R_OUT	Right Channel Output
C4	C _{CP-}	Negative Terminal - Charge Pump Flying Capacitor
D1	+AV _{DD}	Positive Power Supply - Amplifier
D2	L_OUT	Left Channel Output
D3	-AV _{DD}	Negative Power Supply - Amplifier
D4	V _{CP_OUT}	Charge Pump Power Output



These devices have limited built-in ESD protection. The leads should be shorted together or the device placed in conductive foam during storage or handling to prevent electrostatic damage to the MOS gates.

Absolute Maximum Ratings ⁽¹⁾⁽²⁾

Supply Voltage	4.5V
Storage Temperature	-65°C to +150°C
Input Voltage	-0.3V to V _{DD} + 0.3V
Power Dissipation ⁽³⁾	Internally Limited
ESD Susceptibility ⁽⁴⁾	2000V
ESD Susceptibility ⁽⁵⁾	200V
Junction Temperature	150°C
Thermal Resistance	
θ_{JA} (typ) DSBGA ⁽⁶⁾	86°C/W

- (1) Absolute Maximum Ratings indicate limits beyond which damage to the device may occur. Operating Ratings indicate conditions for which the device is functional but do not ensure specific performance limits. Electrical Characteristics state DC and AC electrical specifications under particular test conditions that ensure specific performance limits. This assumes that the device is within the Operating Ratings. Specifications are not ensured for parameters where no limit is given; however, the typical value is a good indication of device performance.
- (2) If Military/Aerospace specified devices are required, please contact the Texas Instruments Sales Office/ Distributors for availability and specifications.
- (3) The maximum power dissipation must be derated at elevated temperatures and is dictated by T_{JMAX}, θ_{JA} , and the ambient temperature, T_A. The maximum allowable power dissipation is P_{DMAX} = (T_{JMAX} - T_A) / θ_{JA} or the number given in Absolute Maximum Ratings, whichever is lower. For the LM4920, see power de-rating currents for more information.
- (4) Human body model, 100pF discharged through a 1.5k Ω resistor.
- (5) Machine Model, 220pF - 240pF discharged through all pins.
- (6) θ_{JA} value is measured with the device mounted on a PCB with a 3" x 1.5", 1oz copper heatsink.

Operating Ratings

Temperature Range	
T _{MIN} ≤ T _A ≤ T _{MAX}	-40°C ≤ T _A ≤ 85°C
Supply Voltage (V _{DD})	1.6V ≤ V _{DD} ≤ 4.2V

Electrical Characteristics $V_{DD} = 3V$ ⁽¹⁾

The following specifications apply for $V_{DD} = 3V$ and 16Ω load unless otherwise specified. Limits apply to $T_A = 25^\circ C$.

Symbol	Parameter	Conditions	LM4920		Units (Limits)
			Typ ⁽²⁾	Limit ^{(3) (4)}	
I_{DD}	Quiescent Power Supply Current Full Power Mode	$V_{IN} = 0V$, inputs terminated both channels enabled	7	10	mA (max)
		$V_{IN} = 0V$, inputs terminated one channel enabled	5		mA
I_{SD}	Shutdown Current	$V_{SD_LC} = V_{SD_RC} = GND$	0.1	1.8	μA (max)
V_{OS}	Output Offset Voltage	$R_L = 32\Omega$, $V_{IN} = 0V$	0.7	5	mV (max)
A_V	Voltage Gain		-1.5		V/V
ΔA_V	Gain Match		1		%
R_{IN}	Input Resistance		20	15 25	k Ω (min) k Ω (max)
P_O	Output Power	THD+N = 1% (max); f = 1kHz, $R_L = 16\Omega$, one channel	80		mW
		THD+N = 1% (max); f = 1kHz, $R_L = 32\Omega$, one channel	65		mW
		THD+N = 1% (max); f = 1kHz, $R_L = 16\Omega$, (two channels in phase)	43	38	mW (min)
		THD+N = 1% (max); f = 1kHz, $R_L = 32\Omega$, (two channels in phase)	50	45	mW (min)
THD+N	Total Harmonic Distortion + Noise	$P_O = 60mW$, f = 1kHz, $R_L = 16\Omega$ single channel	0.04		%
		$P_O = 50mW$, f = 1kHz, $R_L = 32\Omega$ single channel	0.03		
PSRR	Power Supply Rejection Ratio Full Power Mode	$V_{RIPPLE} = 200mVp-p$, Input Referred			
		f = 217Hz	70		dB
		f = 1kHz	65		
		f = 20kHz	50		
SNR	Signal-to-Noise Ratio	$R_L = 32\Omega$, $P_{OUT} = 20mW$, (A-weighted) f = 1kHz, BW = 20Hz to 22kHz	100		dB
V_{IH}	Shutdown Input Voltage High	$V_{DD} = 1.8V$ to 4.2V		1.2	V (min)
V_{IL}	Shutdown Input Voltage Low	$V_{DD} = 1.8V$ to 4.2V		0.45	V (max)
X_{TALK}	Crosstalk	$R_L = 16\Omega$, $P_O = 1.6mW$, f = 1kHz	60		dB
Z_{OUT}	Output Impedance	$V_{SD-LC} = V_{SD-RC} = GND$ Input Terminated Input not terminated	50 ∞	30	k Ω
Z_{OUT}	Output Impedance	$V_{SD-LC} = V_{SD-RC} = GND$ $-500mV \leq V_{OUT} \leq +500mV$ ⁽⁵⁾	8	2	k Ω (min)
I_L	Input Leakage		± 0.1		nA

- (1) All voltages are measured with respect to the GND pin unless otherwise specified.
- (2) Typicals are measured at $25^\circ C$ and represent the parametric norm.
- (3) Limits are specified to AOQL (Average Outgoing Quality Level).
- (4) Datasheet min/max specification limits are specified by design, test, or statistical analysis.
- (5) V_{OUT} refers to signal applied to the LM4920 outputs.

External Components Description

(Figure 1)

Components		Functional Description
1.	C_i	Input coupling capacitor which blocks the DC voltage at the amplifier's input terminals. Also creates a high-pass filter with R_i at $f_c = 1/(2\pi R_i C_i)$. Refer to the section SELECTING PROPER EXTERNAL COMPONENTS for an explanation of how to determine the value of C_i .
2.	C_1	Flying capacitor. Low ESR ceramic capacitor ($\leq 100\text{m}\Omega$)
3.	C_2	Output capacitor. Low ESR ceramic capacitor ($\leq 100\text{m}\Omega$)
4.	C_3	Tantalum capacitor. Supply bypass capacitor which provides power supply filtering. Refer to the POWER SUPPLY BYPASSING section for information concerning proper placement and selection of the supply bypass capacitor.
5.	C_4	Ceramic capacitor. Supply bypass capacitor which provides power supply filtering. Refer to the POWER SUPPLY BYPASSING section for information concerning proper placement and selection of the supply bypass capacitor.

Typical Performance Characteristics

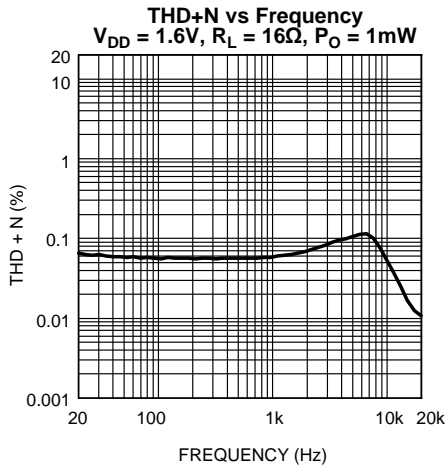

Figure 3.

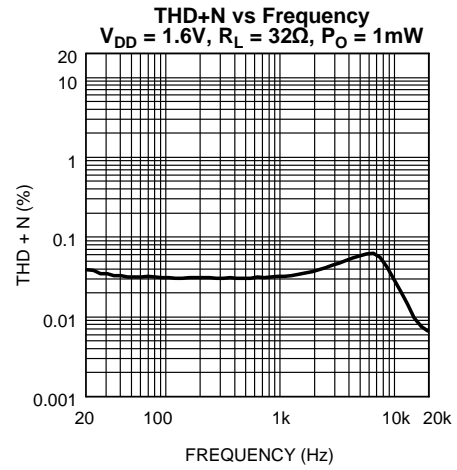

Figure 4.

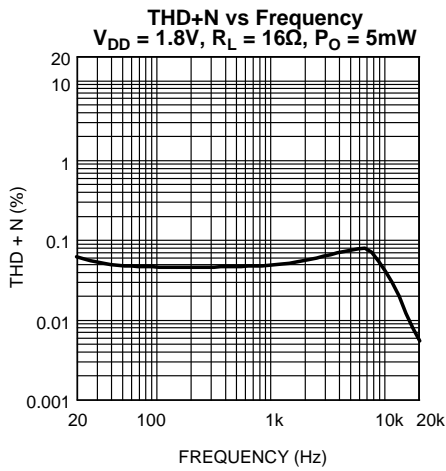

Figure 5.

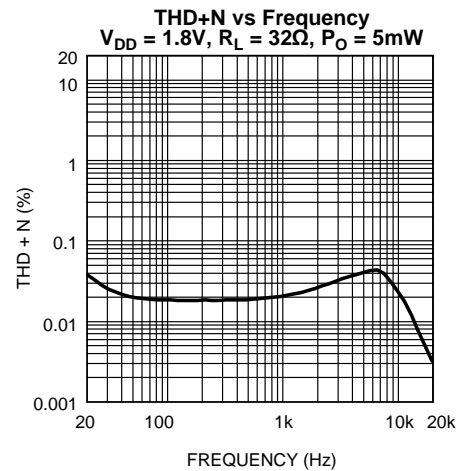

Figure 6.

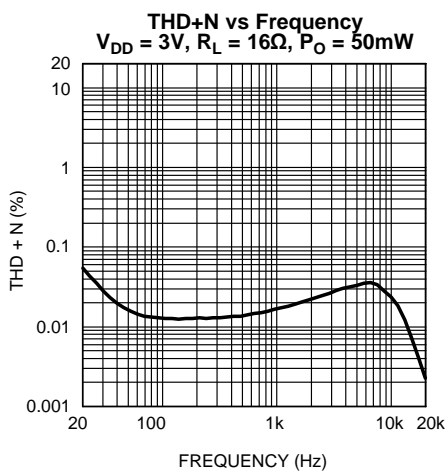

Figure 7.

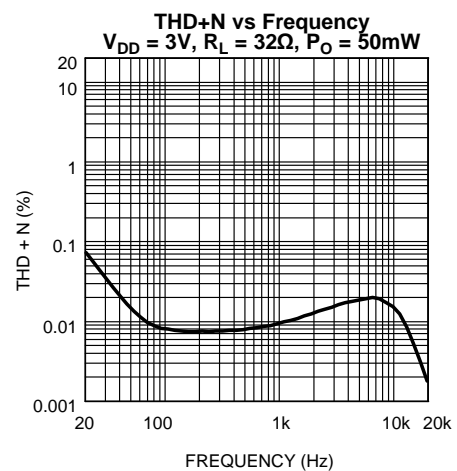

Figure 8.

Typical Performance Characteristics (continued)

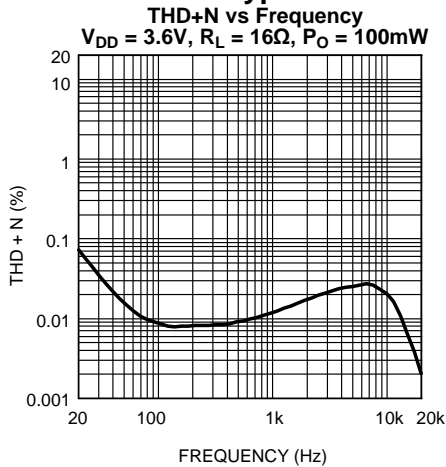

Figure 9.

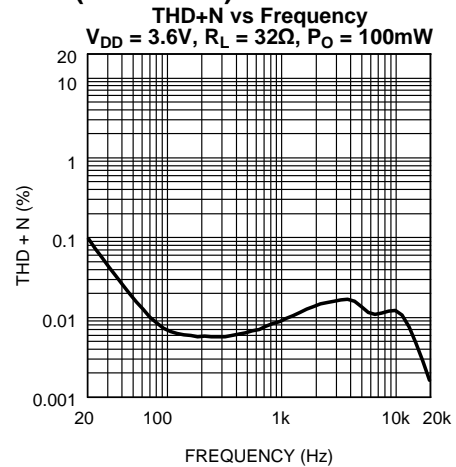

Figure 10.

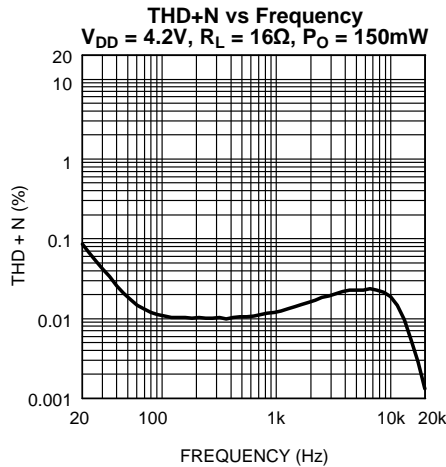

Figure 11.

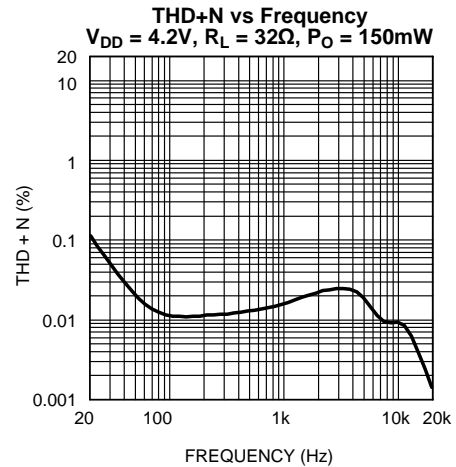

Figure 12.

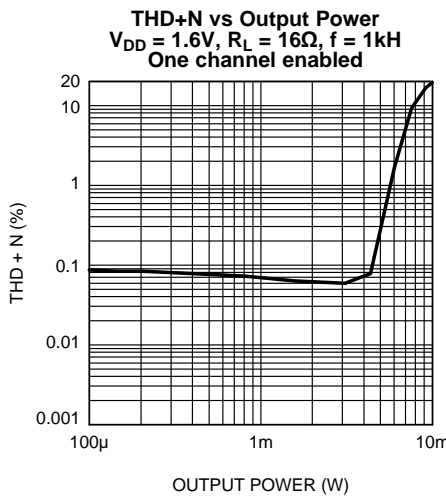

Figure 13.

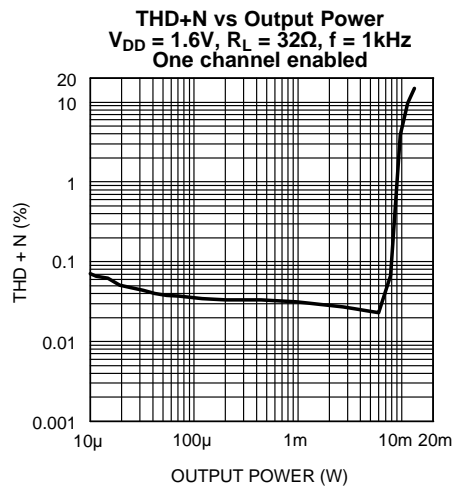

Figure 14.

Typical Performance Characteristics (continued)

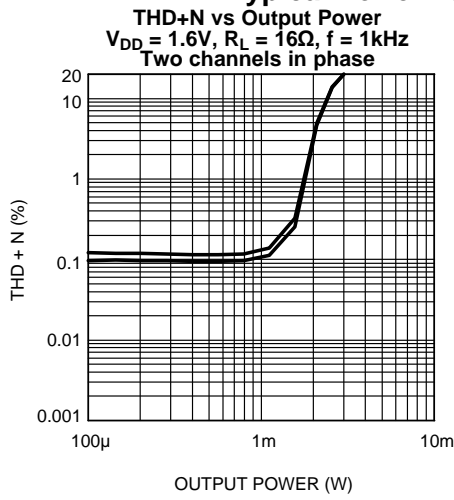

Figure 15.

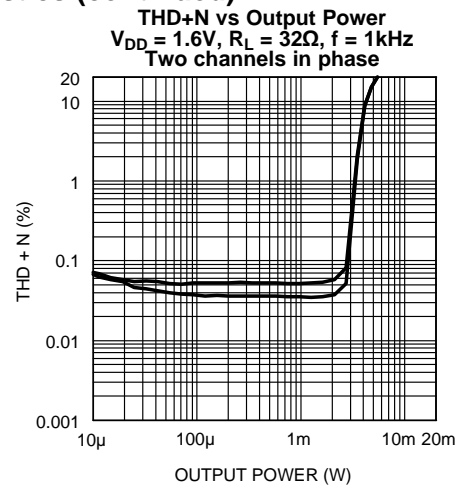

Figure 16.

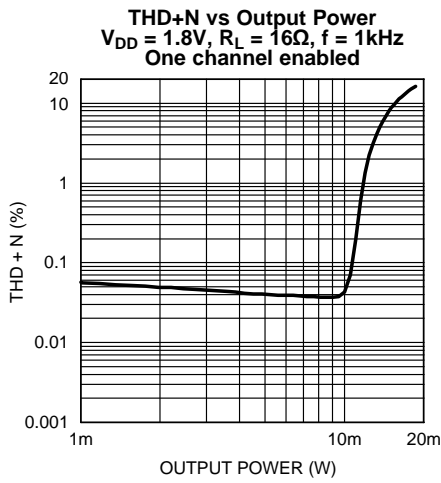

Figure 17.

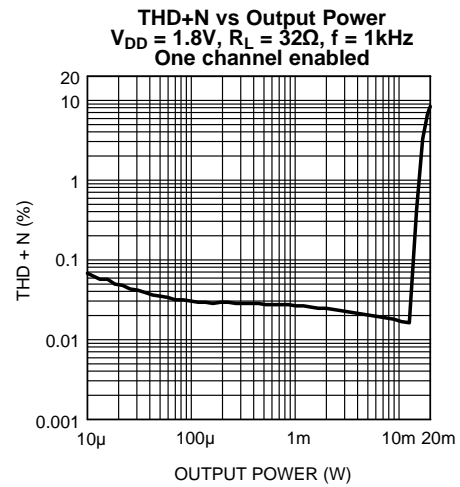

Figure 18.

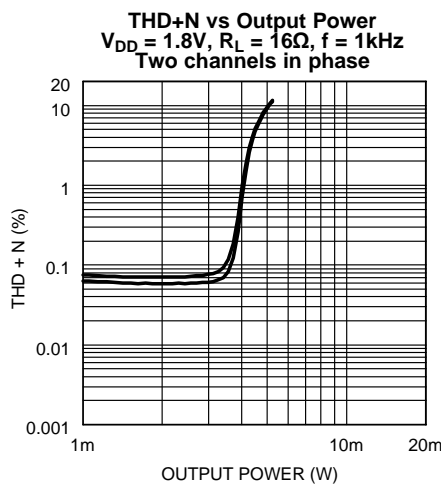

Figure 19.

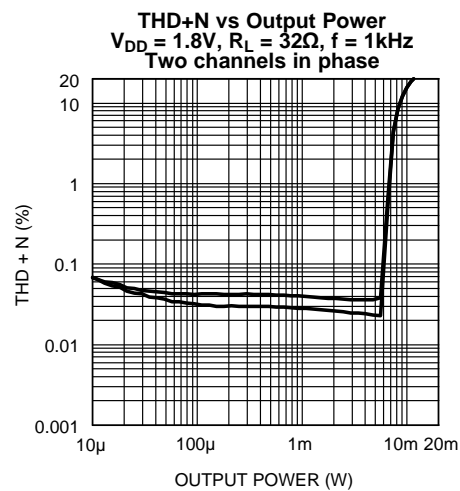

Figure 20.

Typical Performance Characteristics (continued)

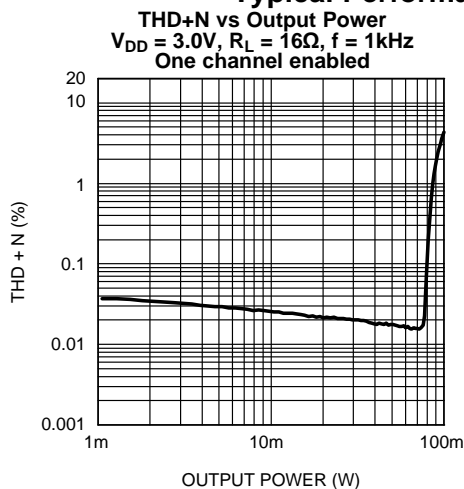

Figure 21.

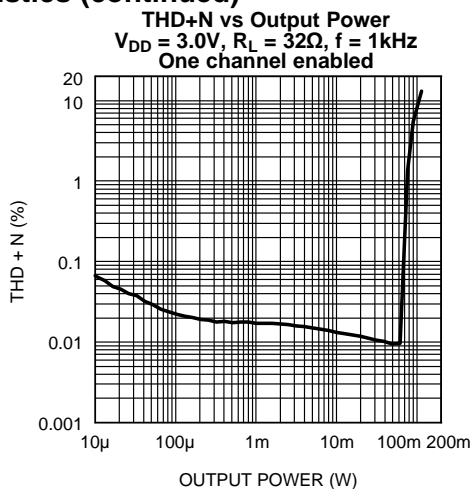

Figure 22.

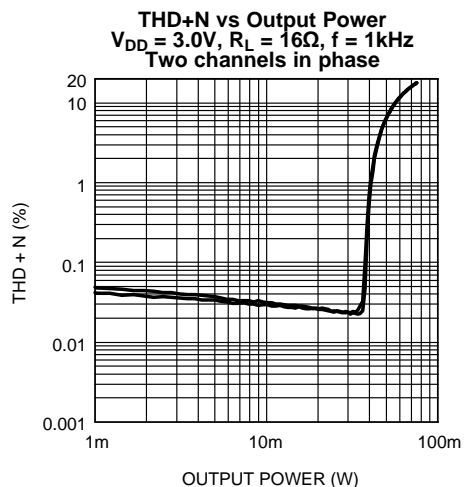

Figure 23.

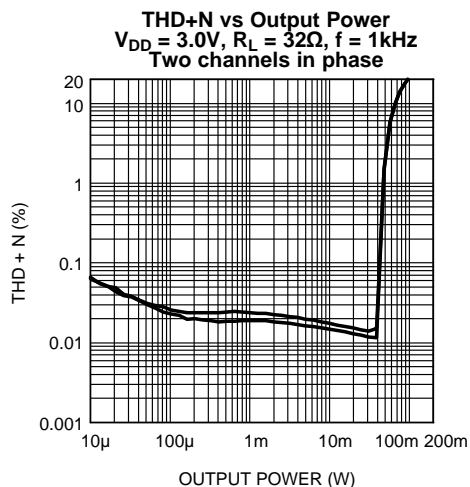

Figure 24.

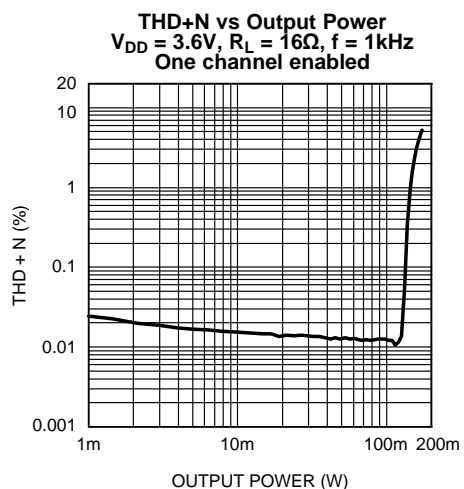

Figure 25.

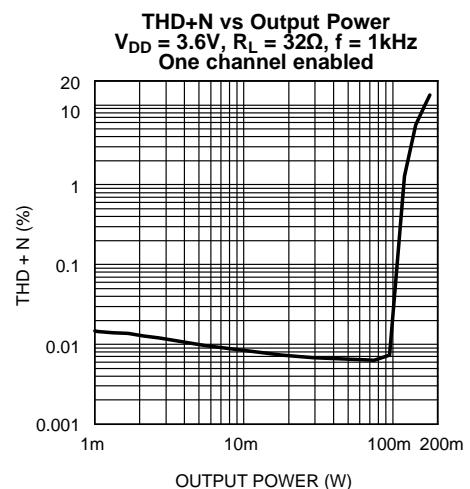

Figure 26.

Typical Performance Characteristics (continued)

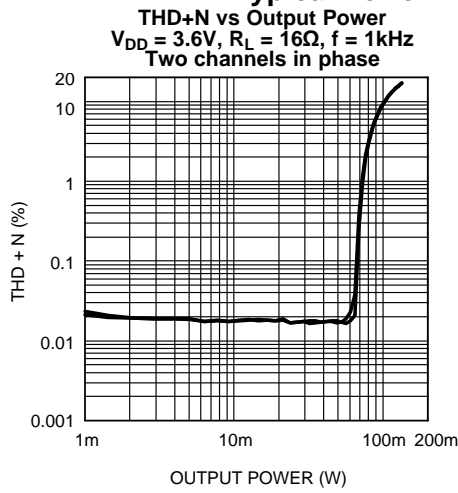

Figure 27.

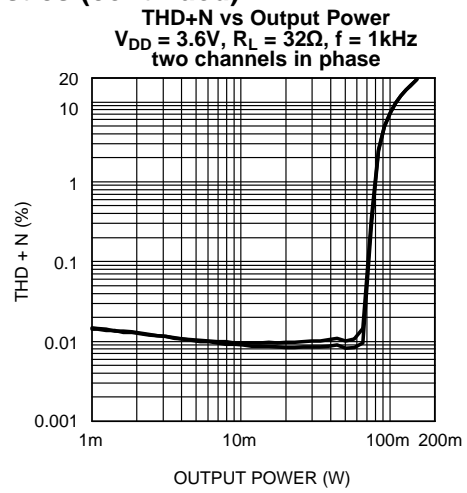

Figure 28.

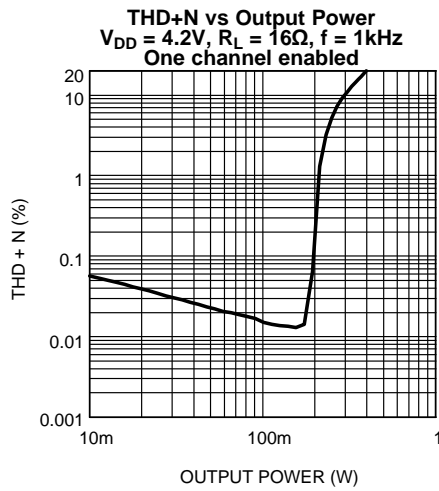

Figure 29.

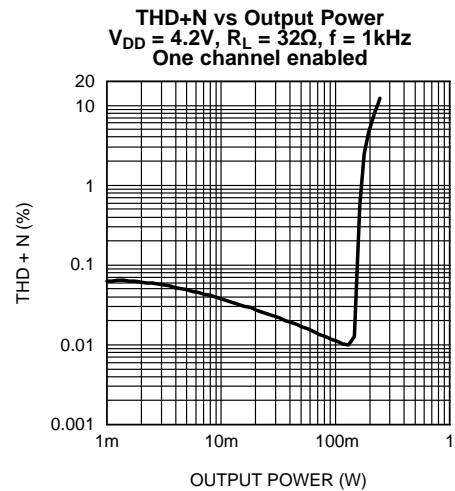

Figure 30.

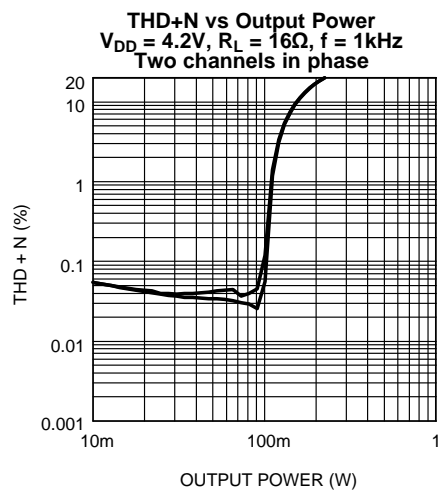

Figure 31.

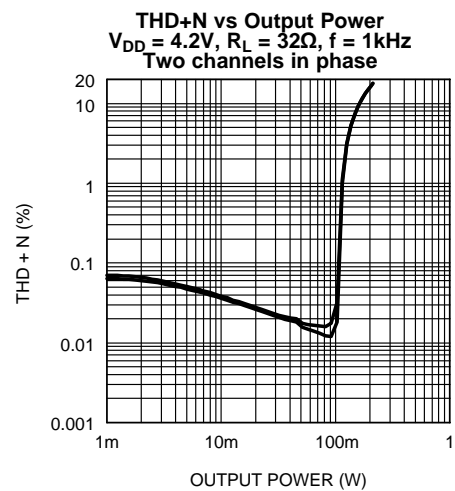

Figure 32.

Typical Performance Characteristics (continued)

PSRR vs Frequency
 $V_{DD} = 1.6V, R_L = 16\Omega$

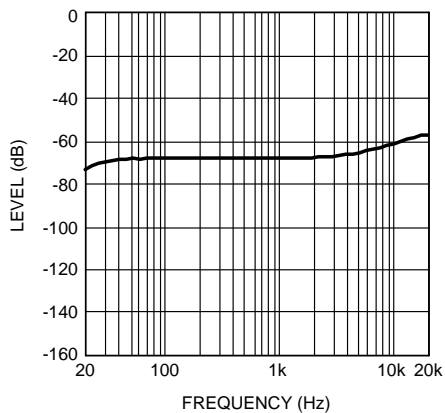

Figure 33.

PSRR vs Frequency
 $V_{DD} = 1.6V, R_L = 32\Omega$

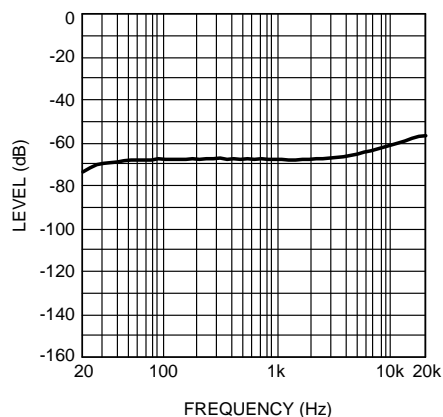

Figure 34.

PSRR vs Frequency
 $V_{DD} = 3V, R_L = 16\Omega$

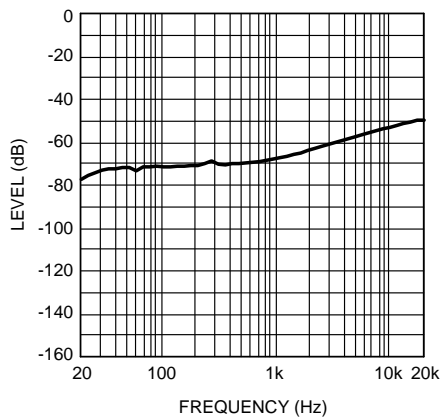

Figure 35.

PSRR vs Frequency
 $V_{DD} = 3V, R_L = 32\Omega$

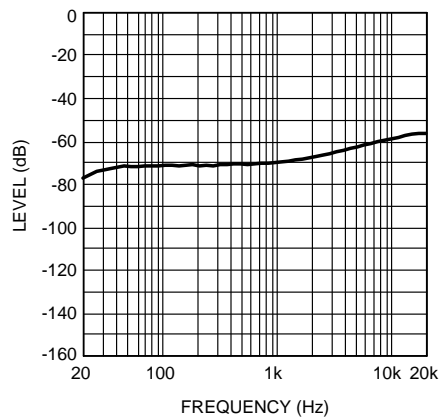

Figure 36.

PSRR vs Frequency
 $V_{DD} = 4.2V, R_L = 16\Omega$

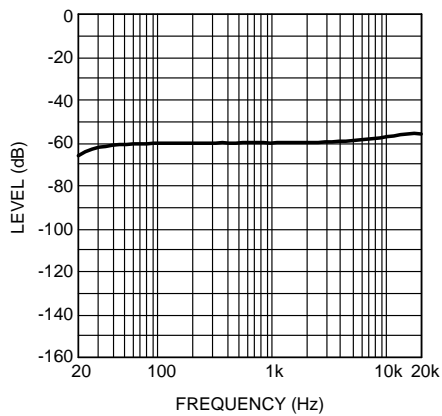

Figure 37.

PSRR vs Frequency
 $V_{DD} = 4.2V, R_L = 32\Omega$

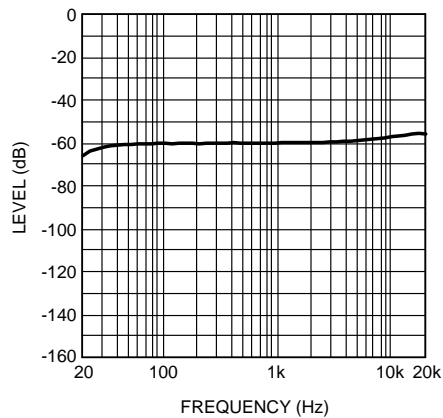

Figure 38.

Typical Performance Characteristics (continued)

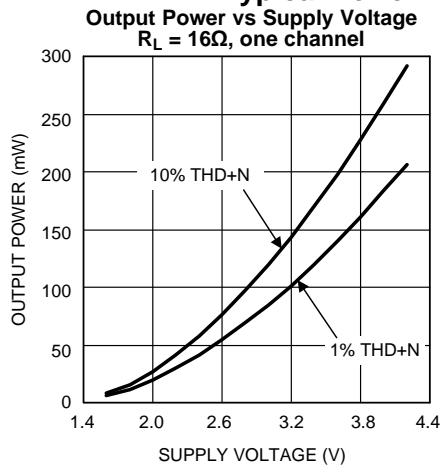

Figure 39.

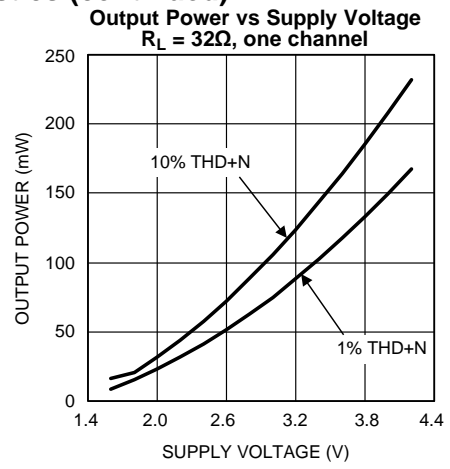

Figure 40.

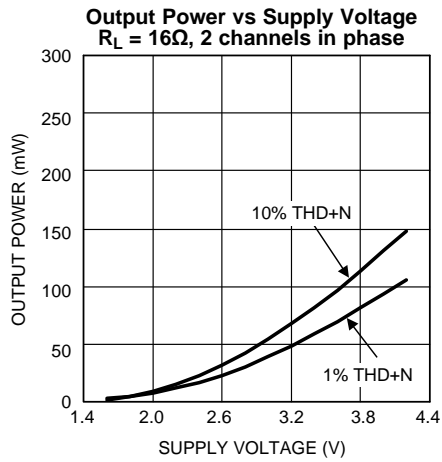

Figure 41.

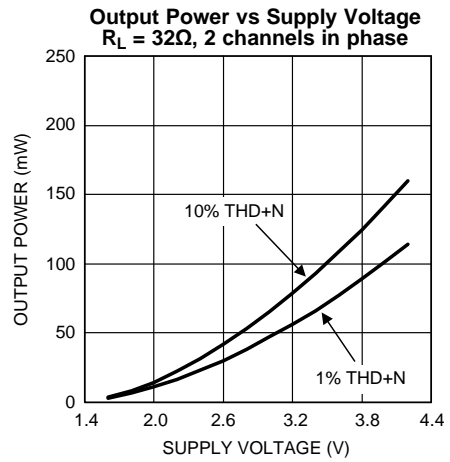

Figure 42.

Supply Current vs Supply Voltage
 $R_L = 16\Omega$

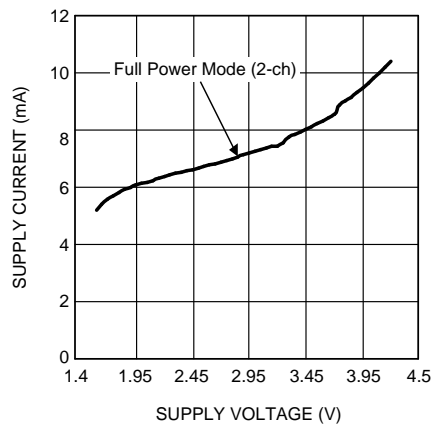

Figure 43.

APPLICATION INFORMATION

SUPPLY VOLTAGE SEQUENCING

It is a good general practice to first apply the supply voltage to a CMOS device before any other signal or supply on other pins. This is also true for the LM4920 audio amplifier which is a CMOS device.

Before applying any signal to the inputs or shutdown pins of the LM4920, it is important to apply a supply voltage to the V_{DD} pins. After the device has been powered, signals may be applied to the shutdown pins (see [MICRO POWER SHUTDOWN](#)) and input pins.

ELIMINATING THE OUTPUT COUPLING CAPACITOR

The LM4920 features a low noise inverting charge pump that generates an internal negative supply voltage. This allows the outputs of the LM4920 to be biased about GND instead of a nominal DC voltage, like traditional headphone amplifiers. Because there is no DC component, the large DC blocking capacitors (typically 220 μ F) are not necessary. The coupling capacitors are replaced by two, small ceramic charge pump capacitors, saving board space and cost.

Eliminating the output coupling capacitors also improves low frequency response. In traditional headphone amplifiers, the headphone impedance and the output capacitor form a high pass filter that not only blocks the DC component of the output, but also attenuates low frequencies, impacting the bass response. Because the LM4920 does not require the output coupling capacitors, the low frequency response of the device is not degraded by external components.

In addition to eliminating the output coupling capacitors, the ground referenced output nearly doubles the available dynamic range of the LM4920 when compared to a traditional headphone amplifier operating from the same supply voltage.

OUTPUT TRANSIENT ('CLICK AND POPS') ELIMINATED

The LM4920 contains advanced circuitry that virtually eliminates output transients ('clicks and pops'). This circuitry prevents all traces of transients when the supply voltage is first applied or when the part resumes operation after coming out of shutdown mode.

AMPLIFIER CONFIGURATION EXPLANATION

As shown in [Figure 1](#), the LM4920 has two internal operational amplifiers. The two amplifiers have internally configured gain, the closed loop gain is set by selecting the ratio of R_f to R_i . Consequently, the gain for each channel of the IC is

$$A_v = -(R_f / R_i) = 1.5 \text{ V/V}$$

where

- $R_f = 30\text{k}\Omega$
 - $R_i = 20\text{k}\Omega$
- (1)

Since this is an output ground-referenced amplifier, by driving the headphone through R_{OUT} (Pin C2) and L_{OUT} (Pin D2), the LM4920 does not require output coupling capacitors. The typical single-ended amplifier configuration requires large, expensive output capacitors.

POWER DISSIPATION

Power dissipation is a major concern when using any power amplifier and must be thoroughly understood to ensure a successful design. [Equation 2](#) states the maximum power dissipation point for a single-ended amplifier operating at a given supply voltage and driving a specified output load.

$$P_{DMAX} = (V_{DD})^2 / (2\pi^2 R_L) \quad (2)$$

Since the LM4920 has two operational amplifiers in one package, the maximum internal power dissipation point is twice that of the number which results from [Equation 2](#). Even with large internal power dissipation, the LM4920 does not require heat sinking over a large range of ambient temperatures. From [Equation 2](#), assuming a 3V power supply and a 16 Ω load, the maximum power dissipation point is 28mW per amplifier. Thus the maximum package dissipation point is 56mW. The maximum power dissipation point obtained must not be greater than the power dissipation that results from [Equation 3](#):

$$P_{DMAX} = (T_{JMAX} - T_A) / (\theta_{JA}) \quad (3)$$

For the DSBGA package, $\theta_{JA} = 105^\circ\text{C/W}$. $T_{JMAX} = 150^\circ\text{C}$ for the LM4920. Depending on the ambient temperature, T_A , of the system surroundings, Equation 3 can be used to find the maximum internal power dissipation supported by the IC packaging. If the result of Equation 2 is greater than that of Equation 3, then either the supply voltage must be decreased, the load impedance increased or T_A reduced. For the typical application of a 3V power supply, with a 16Ω load, the maximum ambient temperature possible without violating the maximum junction temperature is approximately 144°C provided that device operation is around the maximum power dissipation point. Power dissipation is a function of output power and thus, if typical operation is not around the maximum power dissipation point, the ambient temperature may be increased accordingly.

POWER SUPPLY BYPASSING

As with any power amplifier, proper supply bypassing is critical for low noise performance and high power supply rejection. Applications that employ a 3V power supply typically use a $4.7\mu\text{F}$ capacitor in parallel with a $0.1\mu\text{F}$ ceramic filter capacitor to stabilize the power supply's output, reduce noise on the supply line, and improve the supply's transient response. Keep the length of leads and traces that connect capacitors between the LM4920's power supply pin and ground as short as possible.

MICRO POWER SHUTDOWN

The voltage applied to the $\overline{\text{SD_LC}}$ (shutdown left channel) pin and the $\overline{\text{SD_RC}}$ (shutdown right channel) pin controls the LM4920's shutdown function. When active, the LM4920's micropower shutdown feature turns off the amplifiers' bias circuitry, reducing the supply current. The trigger point is 0.45V for a logic-low level, and 1.2V for logic-high level. The low $0.01\mu\text{A}$ (typ) shutdown current is achieved by applying a voltage that is as near as ground as possible to the $\overline{\text{SD_LC}}/\overline{\text{SD_RC}}$ pins. A voltage that is higher than ground may increase the shutdown current.

There are a few ways to control the micro-power shutdown. These include using a single-pole, single-throw switch, a microprocessor, or a microcontroller. When using a switch, connect an external $100\text{k}\Omega$ pull-up resistor between the $\overline{\text{SD_LC}}/\overline{\text{SD_RC}}$ pins and V_{DD} . Connect the switch between the $\overline{\text{SD_LC}}/\overline{\text{SD_RC}}$ pins and ground. Select normal amplifier operation by opening the switch. Closing the switch connects the $\overline{\text{SD_LC}}/\overline{\text{SD_RC}}$ pins to ground, activating micro-power shutdown. The switch and resistor ensure that the $\overline{\text{SD_LC}}/\overline{\text{SD_RC}}$ pins will not float. This prevents unwanted state changes. In a system with a microprocessor or microcontroller, use a digital output to apply the control voltage to the $\overline{\text{SD_LC}}/\overline{\text{SD_RC}}$ pins. Driving the $\overline{\text{SD_LC}}/\overline{\text{SD_RC}}$ pins with active circuitry eliminates the pull-up resistor.

SELECTING PROPER EXTERNAL COMPONENTS

Optimizing the LM4920's performance requires properly selecting external components. Though the LM4920 operates well when using external components with wide tolerances, best performance is achieved by optimizing component values.

Charge Pump Capacitor Selection

Use low ESR (equivalent series resistance) ($<100\text{m}\Omega$) ceramic capacitors with an X7R dielectric for best performance. Low ESR capacitors keep the charge pump output impedance to a minimum, extending the headroom on the negative supply. Higher ESR capacitors result in reduced output power from the audio amplifiers.

Charge pump load regulation and output impedance are affected by the value of the flying capacitor (C1). A larger valued C1 (up to $3.3\mu\text{F}$) improves load regulation and minimizes charge pump output resistance. Beyond $3.3\mu\text{F}$, the switch-on resistance dominates the output impedance for capacitor values above $2.2\mu\text{F}$.

The output ripple is affected by the value and ESR of the output capacitor (C2). Larger capacitors reduce output ripple on the negative power supply. Lower ESR capacitors minimize the output ripple and reduce the output impedance of the charge pump.

The LM4920 charge pump design is optimized for $2.2\mu\text{F}$, low ESR, ceramic, flying, and output capacitors.

Input Capacitor Value Selection

Amplifying the lowest audio frequencies requires high value input coupling capacitors (C_i in Figure 1). A high value capacitor can be expensive and may compromise space efficiency in portable designs. In many cases, however, the speakers used in portable systems, whether internal or external, have little ability to reproduce signals below 150Hz. Applications using speakers with this limited frequency response reap little improvement by using high value input and output capacitors.

Besides affecting system cost and size, C_i has an effect on the LM4920's click and pop performance. The magnitude of the pop is directly proportional to the input capacitor's size. Thus, pops can be minimized by selecting an input capacitor value that is no higher than necessary to meet the desired -3dB frequency.

As shown in Figure 1, the internal input resistor, R_i and the input capacitor, C_i , produce a -3dB high pass filter cutoff frequency that is found using Equation 4. Conventional headphone amplifiers require output capacitors; Equation 4 can be used, along with the value of R_L , to determine towards the value of output capacitor needed to produce a -3dB high pass filter cutoff frequency.

$$f_{i-3\text{dB}} = 1 / 2\pi R_i C_i \quad (4)$$

Also, careful consideration must be taken in selecting a certain type of capacitor to be used in the system. Different types of capacitors (tantalum, electrolytic, ceramic) have unique performance characteristics and may affect overall system performance. (See the section entitled Charge Pump Capacitor Selection.)

LM4920 DSBGA DEMO BOARD ARTWORK

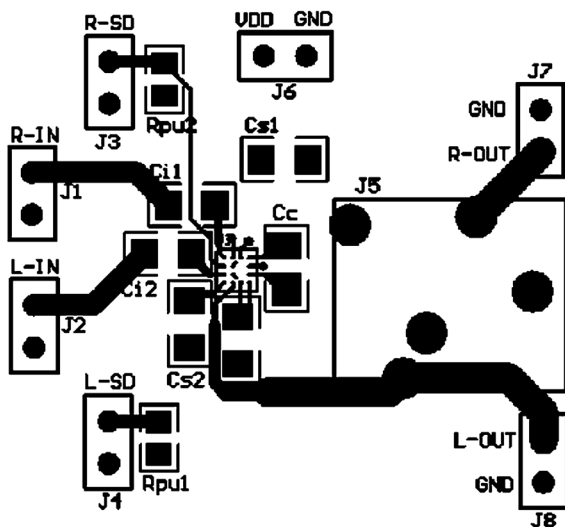

Figure 44. Top Layer

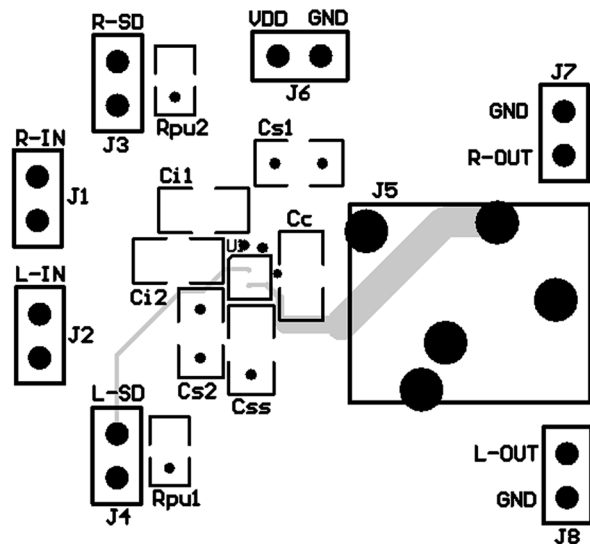

Figure 45. Mid Layer 1

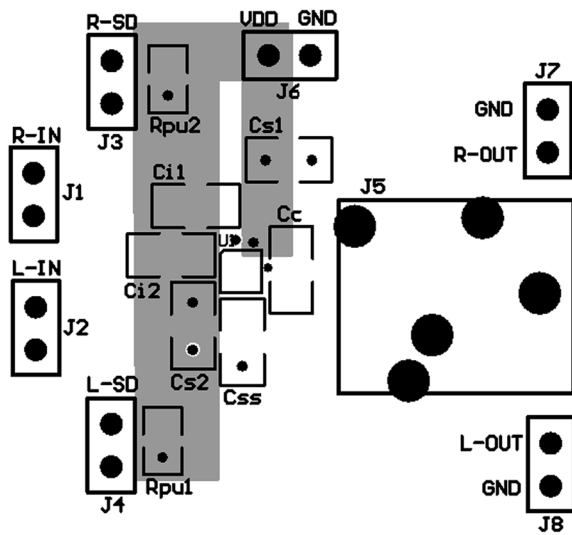

Figure 46. Mid Layer 2

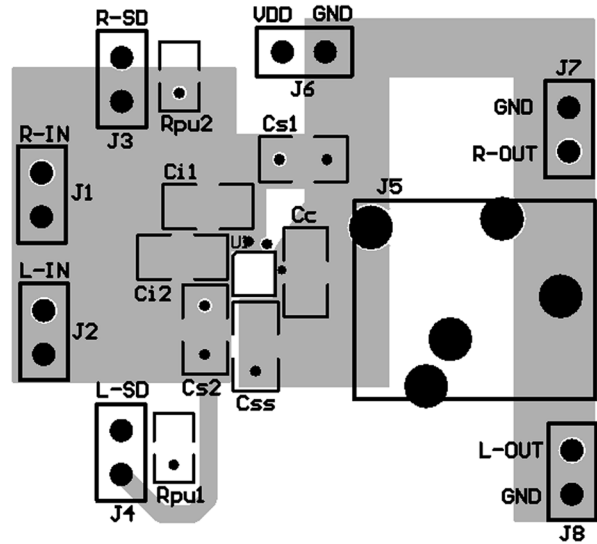

Figure 47. Bottom Layer

Revision History

Rev	Date	Description
1.0	03/27/06	Initial release.
1.1	10/18/06	Text edits.
B	05/03/13	Changed layout of National Data Sheet to TI format.

PACKAGING INFORMATION

Orderable Device	Status (1)	Package Type	Package Drawing	Pins	Package Qty	Eco Plan (2)	Lead/Ball Finish	MSL Peak Temp (3)	Op Temp (°C)	Top-Side Markings (4)	Samples
LM4920TL/NOPB	ACTIVE	DSBGA	YZE	14	250	Green (RoHS & no Sb/Br)	SNAGCU	Level-1-260C-UNLIM	-40 to 85	GH4	Samples
LM4920TLX/NOPB	ACTIVE	DSBGA	YZE	14	3000	Green (RoHS & no Sb/Br)	SNAGCU	Level-1-260C-UNLIM	-40 to 85	GH4	Samples

(1) The marketing status values are defined as follows:

ACTIVE: Product device recommended for new designs.

LIFEBUY: TI has announced that the device will be discontinued, and a lifetime-buy period is in effect.

NRND: Not recommended for new designs. Device is in production to support existing customers, but TI does not recommend using this part in a new design.

PREVIEW: Device has been announced but is not in production. Samples may or may not be available.

OBsolete: TI has discontinued the production of the device.

(2) Eco Plan - The planned eco-friendly classification: Pb-Free (RoHS), Pb-Free (RoHS Exempt), or Green (RoHS & no Sb/Br) - please check <http://www.ti.com/productcontent> for the latest availability information and additional product content details.

TBD: The Pb-Free/Green conversion plan has not been defined.

Pb-Free (RoHS): TI's terms "Lead-Free" or "Pb-Free" mean semiconductor products that are compatible with the current RoHS requirements for all 6 substances, including the requirement that lead not exceed 0.1% by weight in homogeneous materials. Where designed to be soldered at high temperatures, TI Pb-Free products are suitable for use in specified lead-free processes.

Pb-Free (RoHS Exempt): This component has a RoHS exemption for either 1) lead-based flip-chip solder bumps used between the die and package, or 2) lead-based die adhesive used between the die and leadframe. The component is otherwise considered Pb-Free (RoHS compatible) as defined above.

Green (RoHS & no Sb/Br): TI defines "Green" to mean Pb-Free (RoHS compatible), and free of Bromine (Br) and Antimony (Sb) based flame retardants (Br or Sb do not exceed 0.1% by weight in homogeneous material)

(3) MSL, Peak Temp. -- The Moisture Sensitivity Level rating according to the JEDEC industry standard classifications, and peak solder temperature.

(4) Multiple Top-Side Markings will be inside parentheses. Only one Top-Side Marking contained in parentheses and separated by a "~" will appear on a device. If a line is indented then it is a continuation of the previous line and the two combined represent the entire Top-Side Marking for that device.

Important Information and Disclaimer: The information provided on this page represents TI's knowledge and belief as of the date that it is provided. TI bases its knowledge and belief on information provided by third parties, and makes no representation or warranty as to the accuracy of such information. Efforts are underway to better integrate information from third parties. TI has taken and continues to take reasonable steps to provide representative and accurate information but may not have conducted destructive testing or chemical analysis on incoming materials and chemicals. TI and TI suppliers consider certain information to be proprietary, and thus CAS numbers and other limited information may not be available for release.

In no event shall TI's liability arising out of such information exceed the total purchase price of the TI part(s) at issue in this document sold by TI to Customer on an annual basis.

TAPE AND REEL INFORMATION



QUADRANT ASSIGNMENTS FOR PIN 1 ORIENTATION IN TAPE



*All dimensions are nominal

Device	Package Type	Package Drawing	Pins	SPQ	Reel Diameter (mm)	Reel Width W1 (mm)	A0 (mm)	B0 (mm)	K0 (mm)	P1 (mm)	W (mm)	Pin1 Quadrant
LM4920TL/NOPB	DSBGA	YZE	14	250	178.0	8.4	2.18	2.18	0.76	4.0	8.0	Q1
LM4920TLX/NOPB	DSBGA	YZE	14	3000	178.0	8.4	2.18	2.18	0.76	4.0	8.0	Q1

TAPE AND REEL BOX DIMENSIONS

*All dimensions are nominal

Device	Package Type	Package Drawing	Pins	SPQ	Length (mm)	Width (mm)	Height (mm)
LM4920TL/NOPB	DSBGA	YZE	14	250	210.0	185.0	35.0
LM4920TLX/NOPB	DSBGA	YZE	14	3000	210.0	185.0	35.0

YZE0014

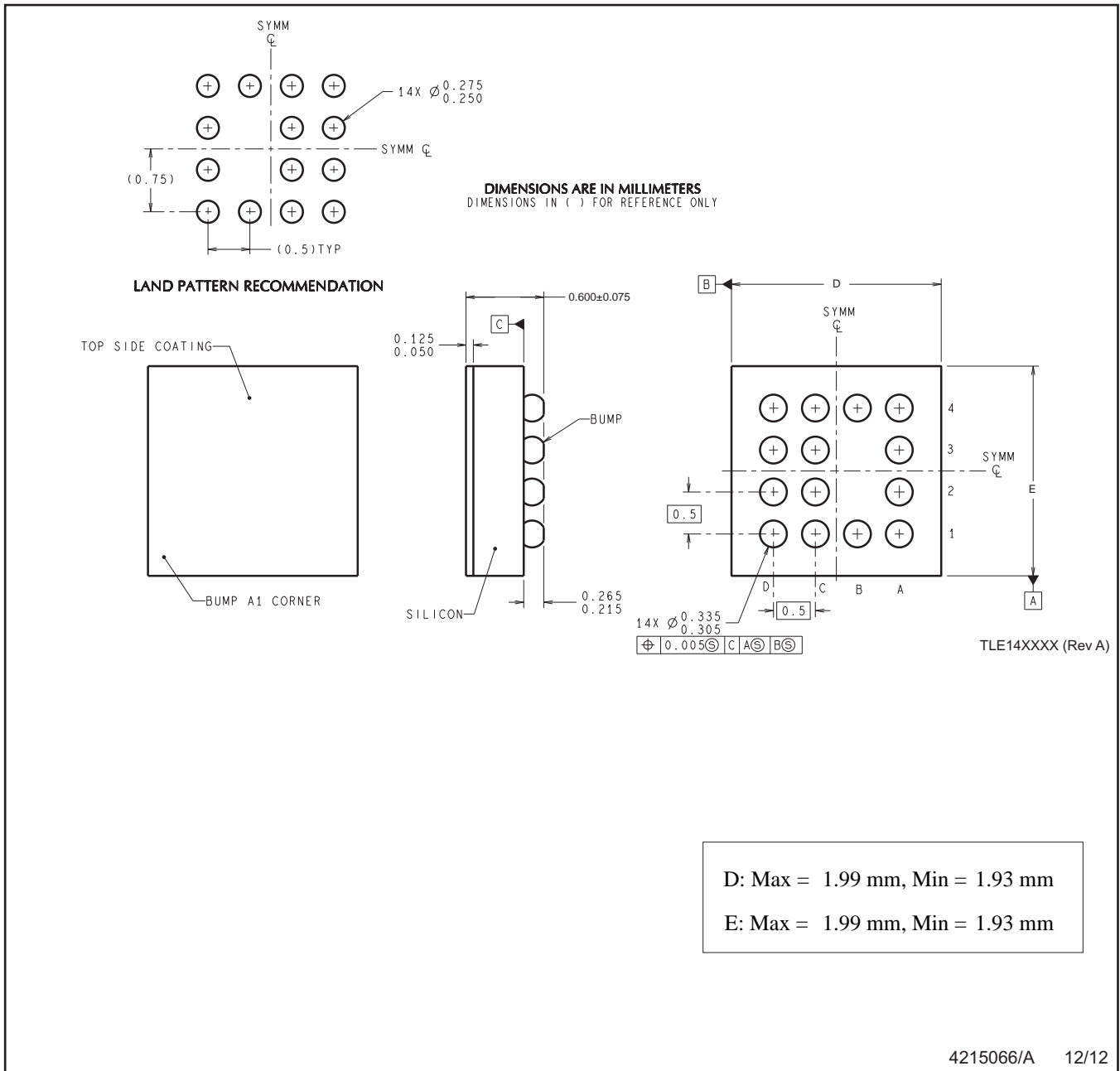

NOTES: A. All linear dimensions are in millimeters. Dimensioning and tolerancing per ASME Y14.5M-1994.
B. This drawing is subject to change without notice.

IMPORTANT NOTICE

Texas Instruments Incorporated and its subsidiaries (TI) reserve the right to make corrections, enhancements, improvements and other changes to its semiconductor products and services per JESD46, latest issue, and to discontinue any product or service per JESD48, latest issue. Buyers should obtain the latest relevant information before placing orders and should verify that such information is current and complete. All semiconductor products (also referred to herein as "components") are sold subject to TI's terms and conditions of sale supplied at the time of order acknowledgment.

TI warrants performance of its components to the specifications applicable at the time of sale, in accordance with the warranty in TI's terms and conditions of sale of semiconductor products. Testing and other quality control techniques are used to the extent TI deems necessary to support this warranty. Except where mandated by applicable law, testing of all parameters of each component is not necessarily performed.

TI assumes no liability for applications assistance or the design of Buyers' products. Buyers are responsible for their products and applications using TI components. To minimize the risks associated with Buyers' products and applications, Buyers should provide adequate design and operating safeguards.

TI does not warrant or represent that any license, either express or implied, is granted under any patent right, copyright, mask work right, or other intellectual property right relating to any combination, machine, or process in which TI components or services are used. Information published by TI regarding third-party products or services does not constitute a license to use such products or services or a warranty or endorsement thereof. Use of such information may require a license from a third party under the patents or other intellectual property of the third party, or a license from TI under the patents or other intellectual property of TI.

Reproduction of significant portions of TI information in TI data books or data sheets is permissible only if reproduction is without alteration and is accompanied by all associated warranties, conditions, limitations, and notices. TI is not responsible or liable for such altered documentation. Information of third parties may be subject to additional restrictions.

Resale of TI components or services with statements different from or beyond the parameters stated by TI for that component or service voids all express and any implied warranties for the associated TI component or service and is an unfair and deceptive business practice. TI is not responsible or liable for any such statements.

Buyer acknowledges and agrees that it is solely responsible for compliance with all legal, regulatory and safety-related requirements concerning its products, and any use of TI components in its applications, notwithstanding any applications-related information or support that may be provided by TI. Buyer represents and agrees that it has all the necessary expertise to create and implement safeguards which anticipate dangerous consequences of failures, monitor failures and their consequences, lessen the likelihood of failures that might cause harm and take appropriate remedial actions. Buyer will fully indemnify TI and its representatives against any damages arising out of the use of any TI components in safety-critical applications.

In some cases, TI components may be promoted specifically to facilitate safety-related applications. With such components, TI's goal is to help enable customers to design and create their own end-product solutions that meet applicable functional safety standards and requirements. Nonetheless, such components are subject to these terms.

No TI components are authorized for use in FDA Class III (or similar life-critical medical equipment) unless authorized officers of the parties have executed a special agreement specifically governing such use.

Only those TI components which TI has specifically designated as military grade or "enhanced plastic" are designed and intended for use in military/aerospace applications or environments. Buyer acknowledges and agrees that any military or aerospace use of TI components which have **not** been so designated is solely at the Buyer's risk, and that Buyer is solely responsible for compliance with all legal and regulatory requirements in connection with such use.

TI has specifically designated certain components as meeting ISO/TS16949 requirements, mainly for automotive use. In any case of use of non-designated products, TI will not be responsible for any failure to meet ISO/TS16949.

Products

Audio	www.ti.com/audio
Amplifiers	amplifier.ti.com
Data Converters	dataconverter.ti.com
DLP® Products	www.dlp.com
DSP	dsp.ti.com
Clocks and Timers	www.ti.com/clocks
Interface	interface.ti.com
Logic	logic.ti.com
Power Mgmt	power.ti.com
Microcontrollers	microcontroller.ti.com
RFID	www.ti-rfid.com
OMAP Applications Processors	www.ti.com/omap
Wireless Connectivity	www.ti.com/wirelessconnectivity

Applications

Automotive and Transportation	www.ti.com/automotive
Communications and Telecom	www.ti.com/communications
Computers and Peripherals	www.ti.com/computers
Consumer Electronics	www.ti.com/consumer-apps
Energy and Lighting	www.ti.com/energy
Industrial	www.ti.com/industrial
Medical	www.ti.com/medical
Security	www.ti.com/security
Space, Avionics and Defense	www.ti.com/space-avionics-defense
Video and Imaging	www.ti.com/video

TI E2E Community

e2e.ti.com