

LM48821 Boomer® Audio Power Amplifier Series Direct Coupled, Ultra Low Noise, 52mW Differential Input Stereo Headphone Amplifier with I²C Volume Control

Check for Samples: [LM48821](#), [LM48821TLEVAL](#)

FEATURES

- Ground Referenced Outputs
- Differential Inputs
- I²C Volume and Mode Controls
- Available in Space-Saving DSBGA Package
- Ultra Low Current Shutdown Mode
- Advanced Output Transient Suppression Circuitry Eliminates Noises During Turn-On and Turn-Off Transitions
- 2.0V to 4.0V Operation (P_{VDD} and S_{VDD})
- 1.8 to 4.0V Operation (I²C_{VDD})
- No Output Coupling Capacitors, Snubber Networks, Bootstrap Capacitors, or Gain-Setting Resistors Required

APPLICATIONS

- Notebook PCs
- Desktop PCs
- Mobile Phones
- PDAs
- Portable Electronic Devices
- MP3 Players

KEY SPECIFICATIONS

- Improved PSRR at 217Hz: 82dB (typ)
- Stereo Output Power at V_{DD} = 3V, R_L = 16Ω, THD+N = 1%: 52mW (typ)
- Mono Output Power at V_{DD} = 3V, R_L = 16Ω, THD+N = 1%: 93mW (typ)
- Shutdown current: 0.1μA (typ)

DESCRIPTION

With its directly-coupled output technology, the LM48821 is a variable gain audio power amplifier capable of delivering 52mW_{RMS} per channel into a 16Ω single-ended load with less than 1% THD+N from a 3V power supply. The I²C volume control has a range of –76dB to 18dB.

The LM48821's Tru-GND technology utilizes advanced charge pump technology to generate the LM48821's negative supply voltage. This eliminates the need for output-coupling capacitors typically used with single-ended loads.

Boomer audio power amplifiers were designed specifically to provide high quality output power with a minimal amount of external components. The LM48821 does not require output coupling capacitors or bootstrap capacitors, and therefore, is ideally suited for mobile phone and other low voltage applications where minimal power consumption is a primary requirement.

The LM48821 incorporates selectable low-power consumption shutdown and channel select modes.

The LM48821 contains advanced output transient suppression circuitry that eliminates noises which would otherwise occur during turn-on and turn-off transitions.



Please be aware that an important notice concerning availability, standard warranty, and use in critical applications of Texas Instruments semiconductor products and disclaimers thereto appears at the end of this data sheet.

All trademarks are the property of their respective owners.

Typical Application

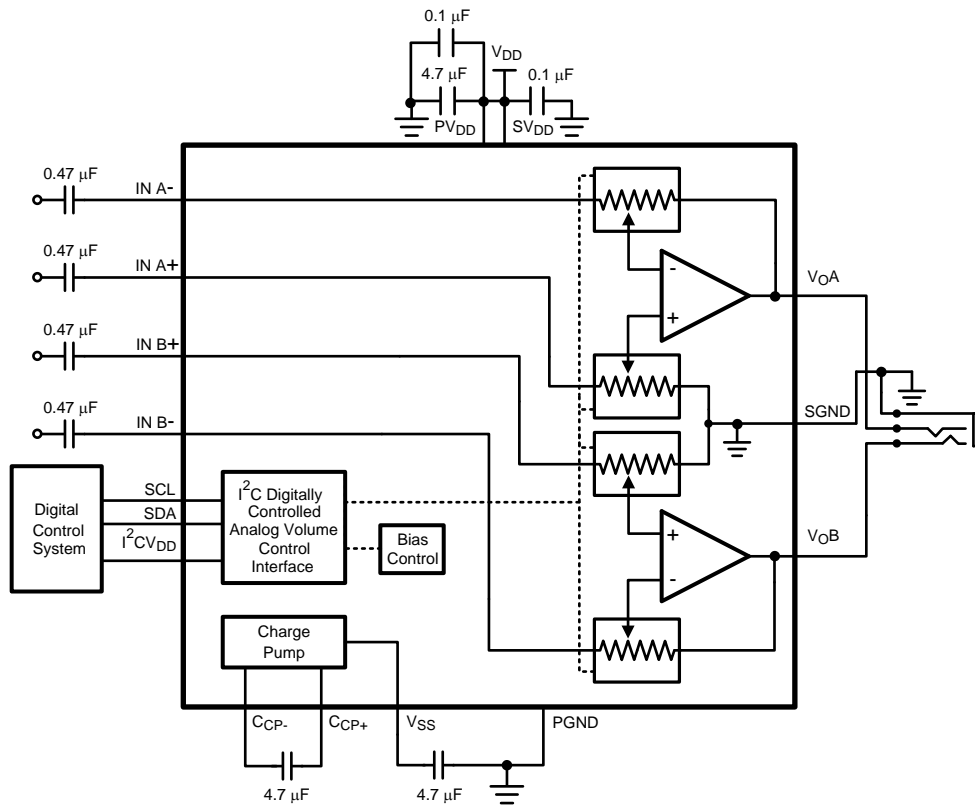

Figure 1. Typical Audio Amplifier Application Circuit

Connection Diagram

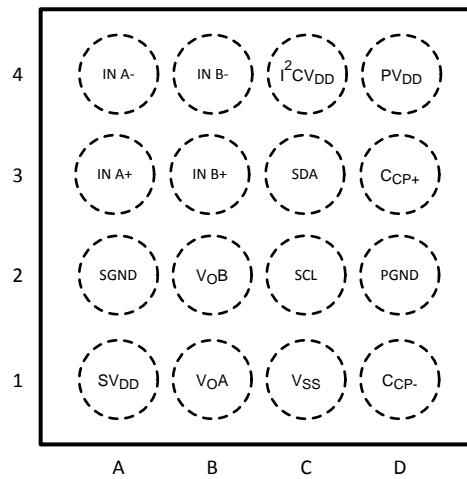

Figure 2. DSBGA - Top View
See YZR0016 Package

PIN DESCRIPTIONS

Pin Designator	Pin Name	Pin Function
A1	SV _{DD}	Signal power supply input
A2	SGND	Signal ground
A3	IN A+	Left non-inverting input
A4	IN A-	Left inverting input
B1	V _O A	Left output
B2	V _O B	Right output
B3	IN B+	Right non-inverting input
B4	IN B-	Right inverting input
C1	V _{SS}	DC to DC converter output
C2	SCL	I ² C serial clock input
C3	SDA	I ² C serial data input
C4	I ² CV _{DD}	I ² C supply voltage input
D1	C _{CP-}	DC to DC converter flying capacitor inverting input
D2	PGND	Power ground
D3	C _{CP+}	DC to DC converter flying capacitor non-inverting input
D4	PV _{DD}	DC to DC converter power supply input



These devices have limited built-in ESD protection. The leads should be shorted together or the device placed in conductive foam during storage or handling to prevent electrostatic damage to the MOS gates.

Absolute Maximum Ratings ⁽¹⁾⁽²⁾⁽³⁾

Supply Voltage	4.5V
Storage Temperature	-65°C to +150°C
Input Voltage	-0.3V to $V_{DD} + 0.3V$
Power Dissipation ⁽⁴⁾	Internally Limited
ESD Susceptibility ⁽⁵⁾	2000V
ESD Susceptibility ⁽⁶⁾	200V
Junction Temperature	150°C
Thermal Resistance	
θ_{JA} (typ) - (DSBGA) ⁽⁴⁾	105°C/W

- (1) All voltages are measured with respect to the GND pin unless otherwise specified.
- (2) Absolute Maximum Ratings indicate limits beyond which damage to the device may occur. Operating Ratings indicate conditions for which the device is functional but do not specify performance limits. Electrical Characteristics state DC and AC electrical specifications under particular test conditions which ensure specific performance limits. This assumes that the device is within the Operating Ratings. Specifications are for parameters where no limit is given, however, the typical value is a good indication of device performance.
- (3) If Military/Aerospace specified devices are required, please contact the Texas Instruments Sales Office/ Distributors for availability and specifications.
- (4) The maximum power dissipation must be derated at elevated temperatures and is dictated by T_{JMAX} , θ_{JA} , and the ambient temperature, T_A . The maximum allowable power dissipation is $P_{DMAX} = (T_{JMAX} - T_A) / \theta_{JA}$ or the number given in Absolute Maximum Ratings, whichever is lower. For the LM48821, see power derating currents for more information.
- (5) Human body model, 100pF discharged through a 1.5k Ω resistor.
- (6) Machine Model, 220pF - 240pF discharged through all pins.

Operating Ratings

Temperature Range	
$T_{MIN} \leq T_A \leq T_{MAX}$	-40°C $\leq T_A \leq$ +85°C
Supply Voltage	
PV_{DD} and SV_{DD}	$2.0V \leq V_{DD} \leq 4.0V$
I^2CV_{DD}	$1.8V \leq I^2CV_{DD} \leq 4.0V$

Audio Amplifier Electrical Characteristics $V_{DD} = 3V$ ⁽¹⁾

The following specifications apply for $V_{DD} = 3V$, $R_L = 16\Omega$, $A_V = 0dB$, unless otherwise specified. Limits apply for $T_A = 25^\circ C$.

Symbol	Parameter	Conditions	LM48821		Units (Limits)
			Typical ⁽²⁾	Limits ^{(3) (4)}	
I_{DD}	Quiescent Power Supply Current	$V_{IN} = 0V$, inputs terminated, both channels enabled	3.0	4.5	mA (max)
		$V_{IN} = 0V$, inputs terminated, one channel enabled	2.0	3.0	mA
I_{SD}	Shutdown Current	Right and Left Enable bits set to 0	0.1	1.2	μA (max)
V_{OS}	Output Offset Voltage	$R_L = 32\Omega$	0.5	2.5	mV (max)
A_V	Volume Control Range	[B0:B4] = 00000	-76		dB
		[B0:B4] = 11111	+18		dB
ΔA_V	Channel-to-Channel Gain Match		± 0.015		dB
A_{V-MUTE}	Mute Gain		-76		dB
R_{IN}	Input Resistance	Gain = 18dB	9	5 15	k Ω (min) k Ω (max)
		Gain = -76dB	81		k Ω

- (1) All voltages are measured with respect to the GND pin unless otherwise specified.
- (2) Typicals are measured at +25°C and represent the parametric norm.
- (3) Limits are specified to AOQL (Average Outgoing Quality Level).
- (4) Data sheet min and /max specification limits are specified by design, test, or statistical analysis.

Audio Amplifier Electrical Characteristics $V_{DD} = 3V$ ⁽¹⁾ (continued)

 The following specifications apply for $V_{DD} = 3V$, $R_L = 16\Omega$, $A_V = 0dB$, unless otherwise specified. Limits apply for $T_A = 25^\circ C$.

Symbol	Parameter	Conditions	LM48821		Units (Limits)
			Typical ⁽²⁾	Limits ^{(3) (4)}	
P _{OUT}	Output Power	THD+N = 1% (max); f _{IN} = 1kHz, R _L = 16Ω, per channel	52	43	mW (min)
		THD+N = 1% (max); f _{IN} = 1kHz, R _L = 32Ω, per channel	53	45	mW (min)
		THD+N = 1% (max); f _{IN} = 1kHz, R _L = 16Ω, single channel driven	93	80	mW (min)
		THD+N = 1% (max); f _{IN} = 1kHz, R _L = 32Ω, single channel driven	79		mW
THD+N	Total Harmonic Distortion + Noise	P _{OUT} = 50mW, f = 1kHz R _L = 16Ω, single channel	0.022		%
		P _{OUT} = 50mW, f = 1kHz R _L = 32Ω, single channel	0.011		%
PSRR	Power Supply Rejection Ratio	V _{RIPPLE} = 200mV _{P-P} , input referred		65	
		f = 217Hz	82		dB (min)
		f = 1kHz	80		dB
		f = 20kHz	55		dB
CMRR	Common Mode Rejection Ratio	V _{RIPPLE} = 200mV _{P-P} , Input referred f = 2kHz	65		dB
SNR	Signal-to-Noise-Ratio	R _L = 32Ω, P _{OUT} = 20mW, f = 1kHz, BW = 20Hz to 22kHz	100		dB
T _{WU}	Charge Pump Wake-Up Time		400		μs
X _{TALK}	Crosstalk	R _L = 16Ω, P _{OUT} = 1.6mW, f = 1kHz, A-weighted filter	82		dB
Z _{OUT}	Output Impedance	Right and Left Enable bits set to 0	41		kΩ

Control Interface Electrical Characteristics ⁽¹⁾

 The following specifications apply for $1.8V \leq I^2CV_{DD} \leq 4.0V$, unless otherwise specified. Limits apply for $T_A = 25^\circ C$. See [Figure 56](#).

Symbol	Parameter	Conditions	LM48821		Units (Limits)
			Typical ⁽²⁾	Limits ^{(3) (4)}	
t ₁	SCL period			2.5	μs (min)
t ₂	SDA Setup Time			100	ns (min)
t ₃	SDA Stable Time			0	ns (min)
t ₄	Start Condition Time			100	ns (min)
t ₅	Stop Condition Time			100	ns (min)
V _{IH}	Logic High Input Threshold			0.7 x I ² CV _{DD}	V (min)
V _{IL}	Logic Low Input Threshold			0.3 x I ² CV _{DD}	V (max)

- (1) All voltages are measured with respect to the GND pin unless otherwise specified.
- (2) Typicals are measured at +25°C and represent the parametric norm.
- (3) Limits are specified to AOQL (Average Outgoing Quality Level).
- (4) Data sheet min and /max specification limits are specified by design, test, or statistical analysis.

Typical Performance Characteristics

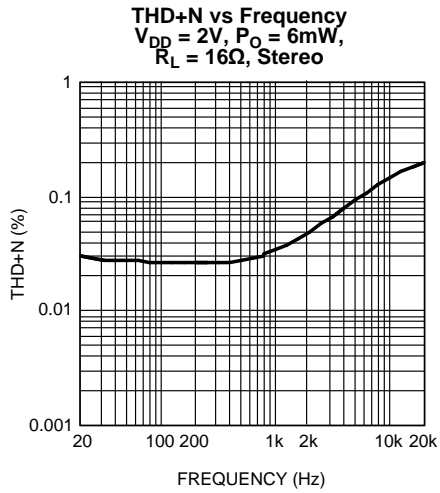

Figure 3.

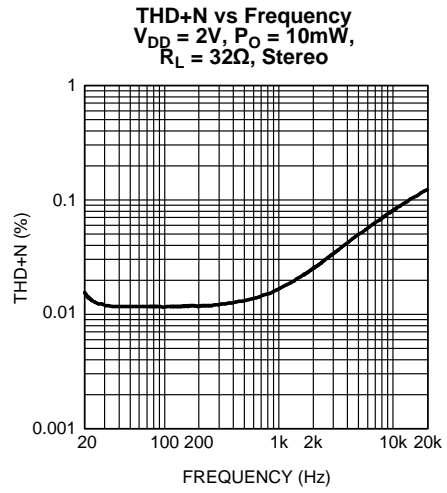

Figure 4.

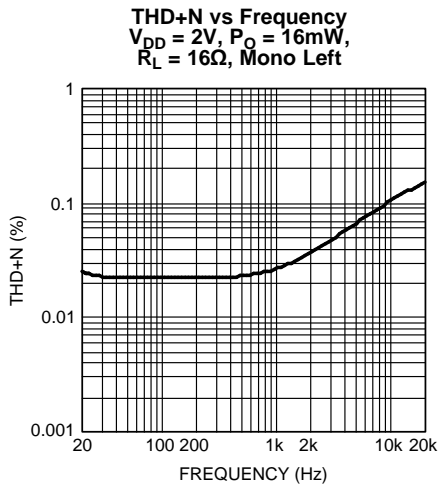

Figure 5.

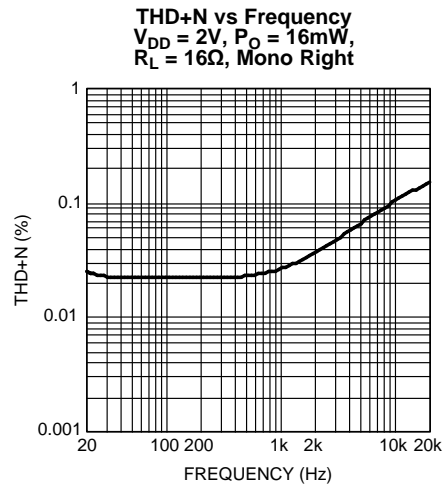

Figure 6.

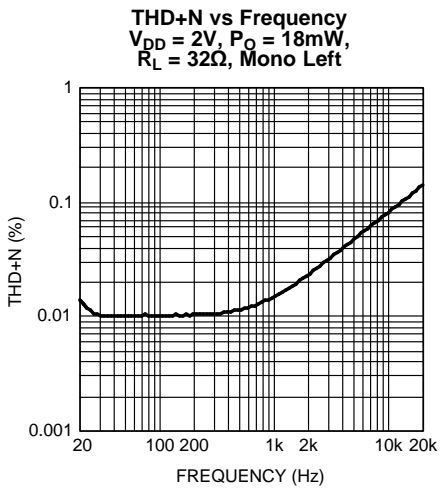

Figure 7.

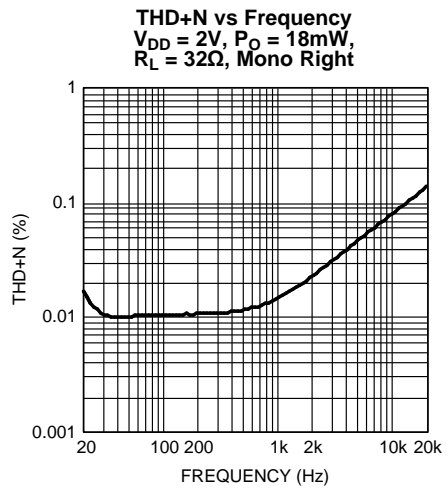

Figure 8.

Typical Performance Characteristics (continued)

THD+N vs Frequency
 $V_{DD} = 3V, P_O = 35mW,$
 $R_L = 16\Omega, \text{Stereo}$

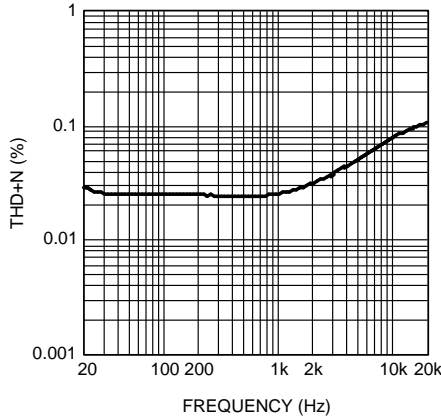

Figure 9.

THD+N vs Frequency
 $V_{DD} = 4V, P_O = 50mW,$
 $R_L = 16\Omega, \text{Stereo}$

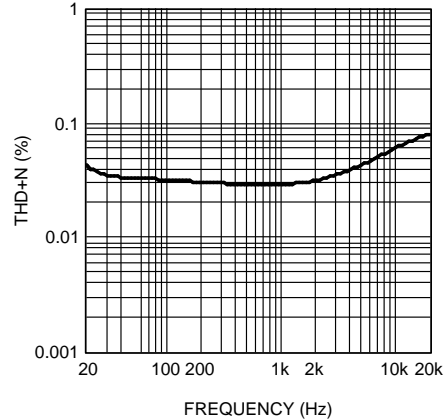

Figure 10.

THD+N vs Frequency
 $V_{DD} = 3V, P_O = 70mW,$
 $R_L = 16\Omega, \text{Mono Left}$

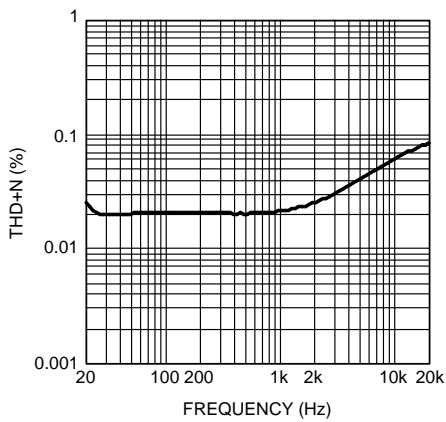

Figure 11.

THD+N vs Frequency
 $V_{DD} = 3V, P_O = 70mW,$
 $R_L = 16\Omega, \text{Mono Right}$

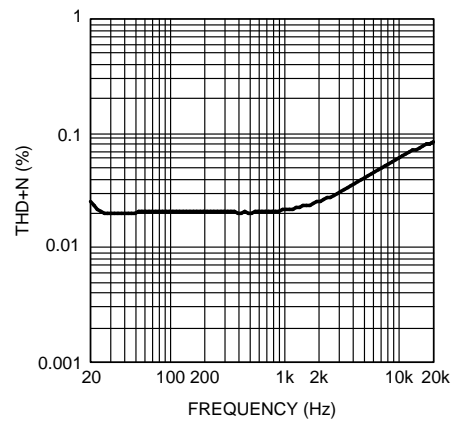

Figure 12.

THD+N vs Frequency
 $V_{DD} = 4V, P_O = 160mW,$
 $R_L = 16\Omega, \text{Mono Left}$

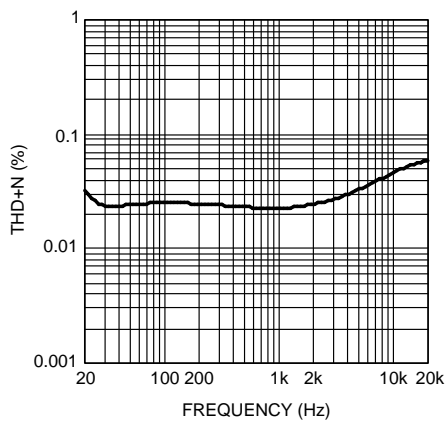

Figure 13.

THD+N vs Frequency
 $V_{DD} = 4V, P_O = 160mW,$
 $R_L = 16\Omega, \text{Mono Right}$

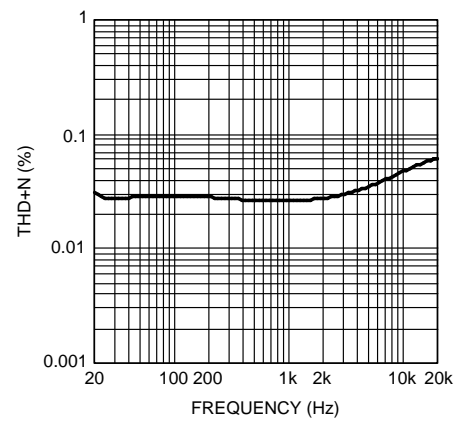

Figure 14.

Typical Performance Characteristics (continued)

THD+N vs Frequency
 $V_{DD} = 3V, P_O = 40mW,$
 $R_L = 32\Omega, \text{Stereo}$

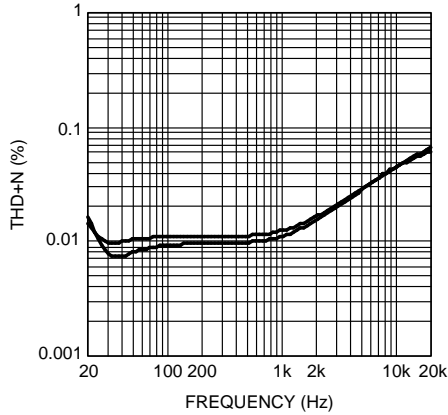

Figure 15.

THD+N vs Frequency
 $V_{DD} = 3V, P_O = 60mW,$
 $R_L = 32\Omega, \text{Mono Left}$

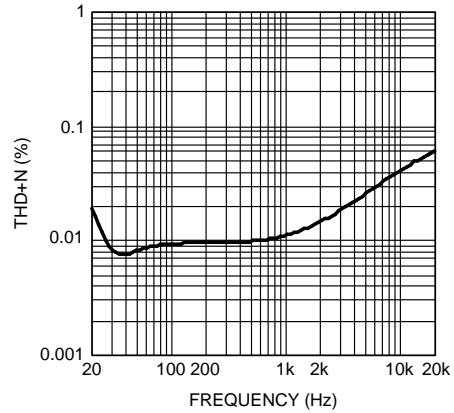

Figure 16.

THD+N vs Frequency
 $V_{DD} = 3V, P_O = 60mW,$
 $R_L = 32\Omega, \text{Mono Right}$

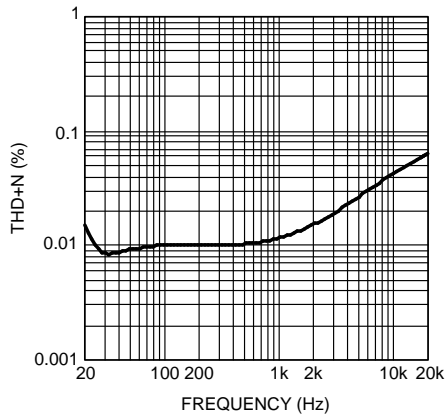

Figure 17.

THD+N vs Frequency
 $V_{DD} = 4V, P_O = 90mW,$
 $R_L = 32\Omega, \text{Stereo}$

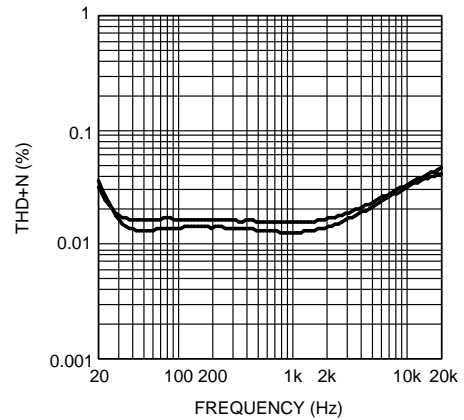

Figure 18.

THD+N vs Frequency
 $V_{DD} = 4V, P_O = 120mW,$
 $R_L = 32\Omega, \text{Mono Left}$

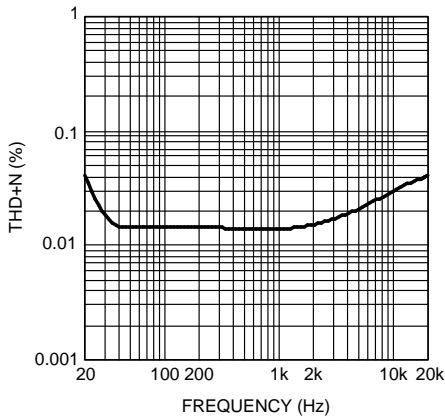

Figure 19.

THD+N vs Frequency
 $V_{DD} = 4V, P_O = 120mW,$
 $R_L = 32\Omega, \text{Mono Right}$

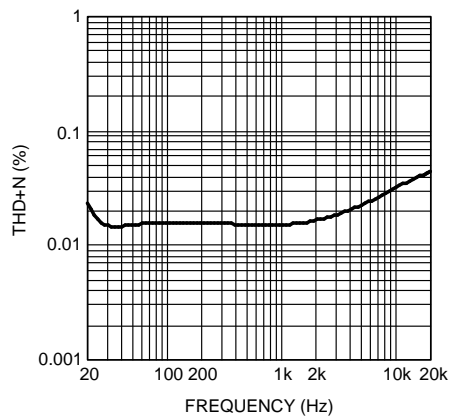

Figure 20.

Typical Performance Characteristics (continued)

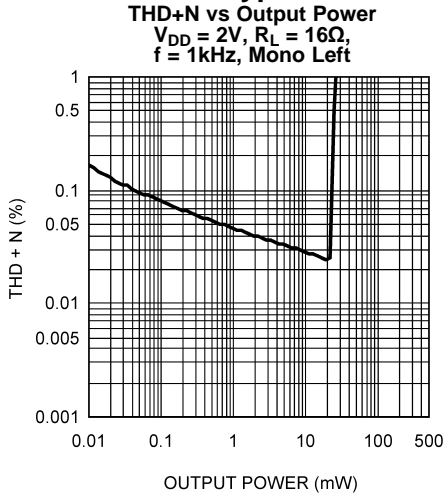

Figure 21.

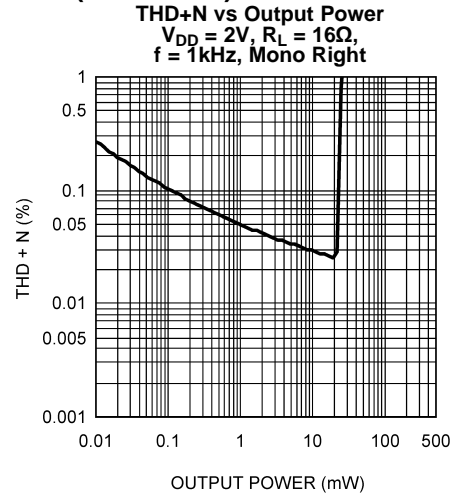

Figure 22.

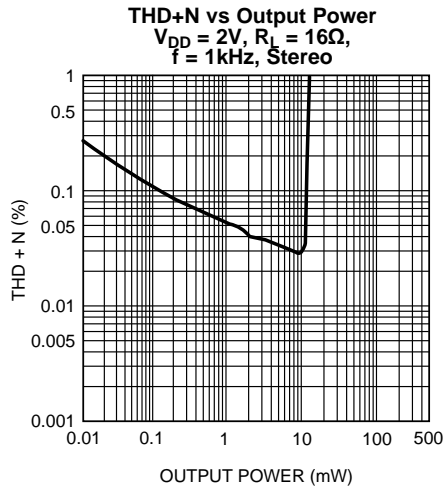

Figure 23.

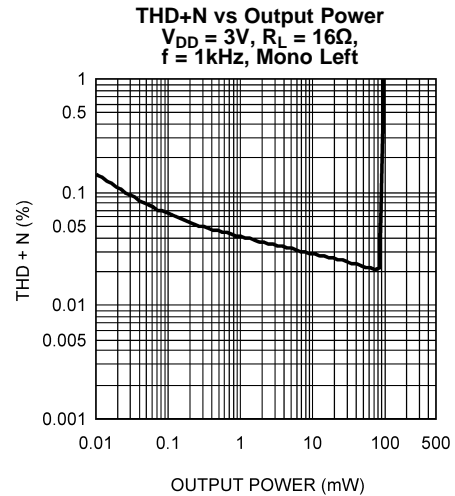

Figure 24.

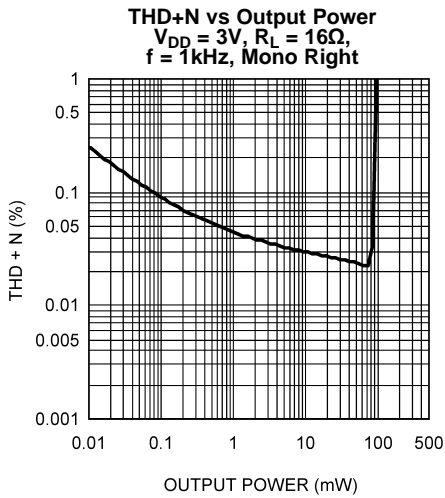

Figure 25.

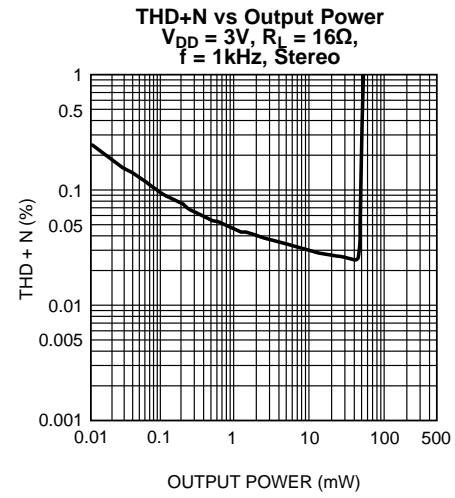

Figure 26.

Typical Performance Characteristics (continued)

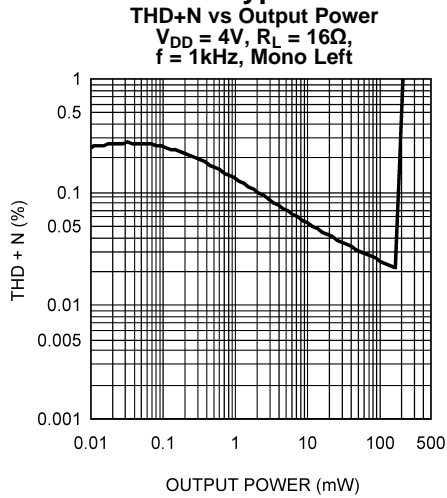

Figure 27.

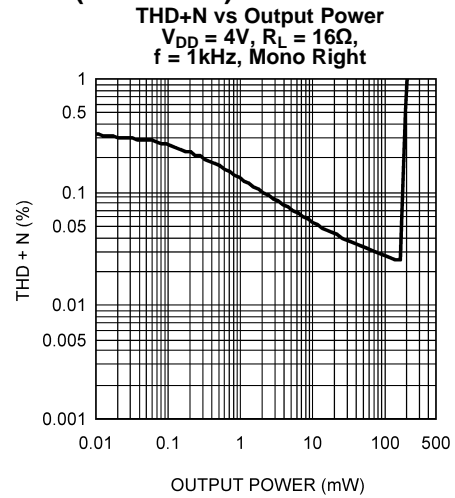

Figure 28.

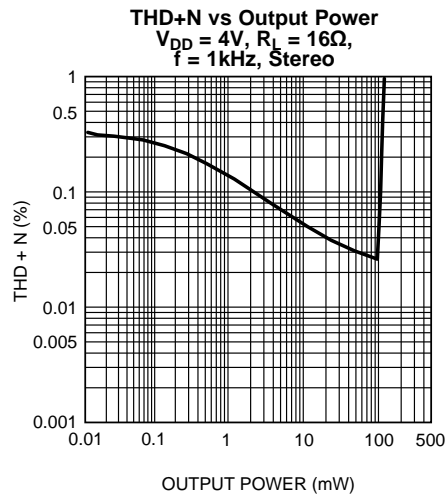

Figure 29.

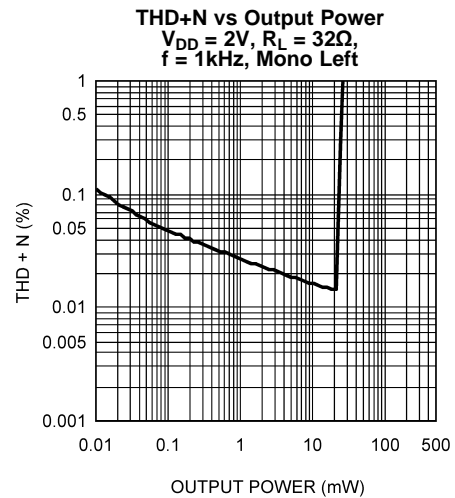

Figure 30.

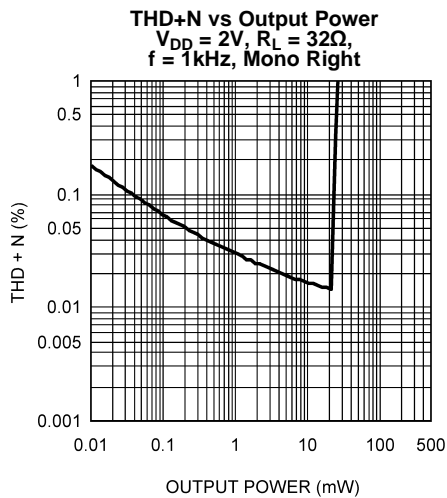

Figure 31.

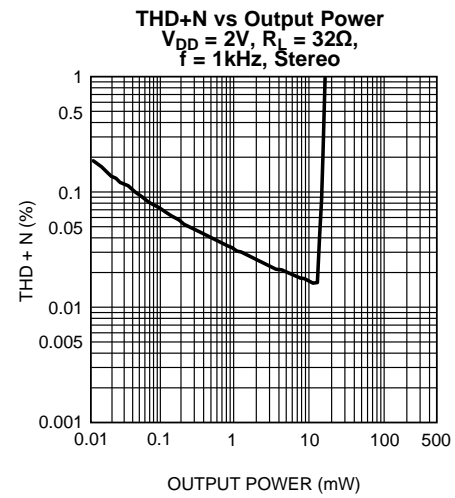

Figure 32.

Typical Performance Characteristics (continued)

THD+N vs Output Power
 $V_{DD} = 3V, R_L = 32\Omega,$
 $f = 1kHz, \text{Mono Left}$

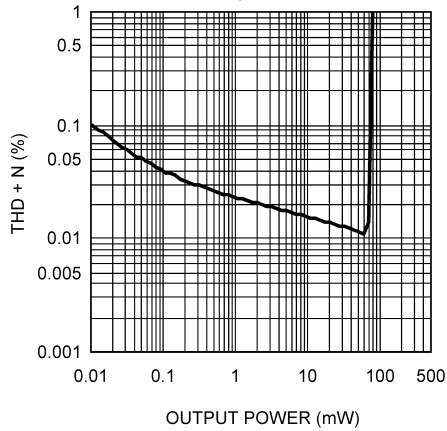

Figure 33.

THD+N vs Output Power
 $V_{DD} = 3V, R_L = 32\Omega,$
 $f = 1kHz, \text{Mono Right}$

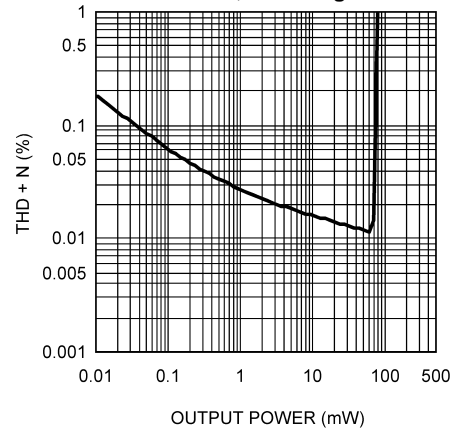

Figure 34.

THD+N vs Output Power
 $V_{DD} = 3V, R_L = 32\Omega,$
 $f = 1kHz, \text{Stereo}$

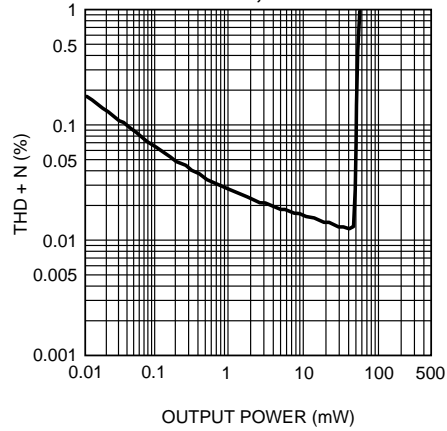

Figure 35.

THD+N vs Output Power
 $V_{DD} = 4V, R_L = 32\Omega,$
 $f = 1kHz, \text{Mono Left}$

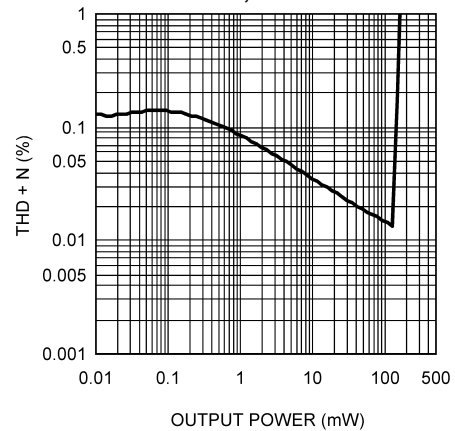

Figure 36.

THD+N vs Output Power
 $V_{DD} = 4V, R_L = 32\Omega,$
 $f = 1kHz, \text{Mono Right}$

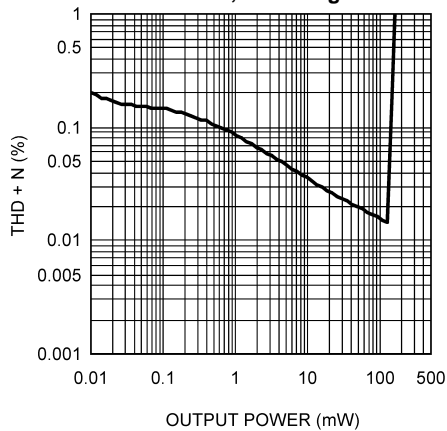

Figure 37.

THD+N vs Output Power
 $V_{DD} = 4V, R_L = 32\Omega,$
 $f = 1kHz, \text{Stereo}$

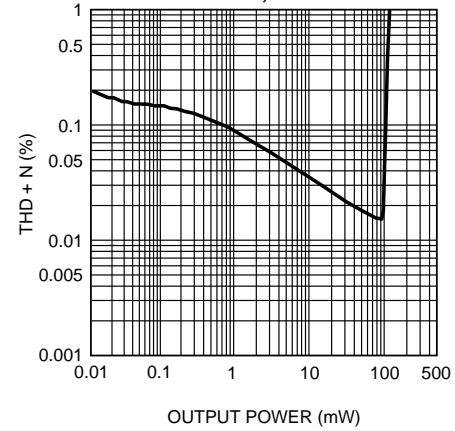

Figure 38.

Typical Performance Characteristics (continued)

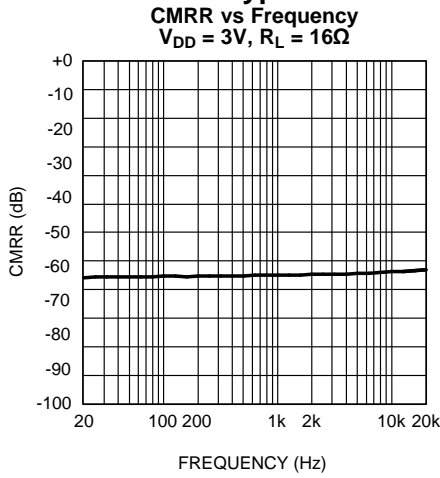

Figure 39.

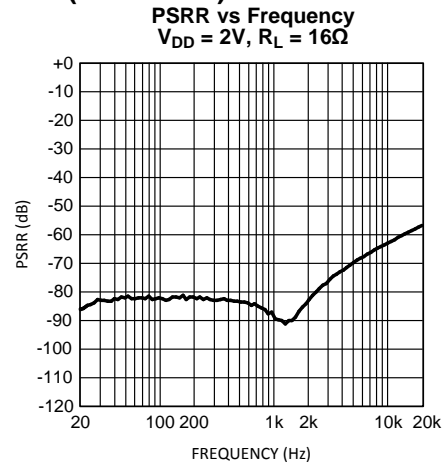

Figure 40.

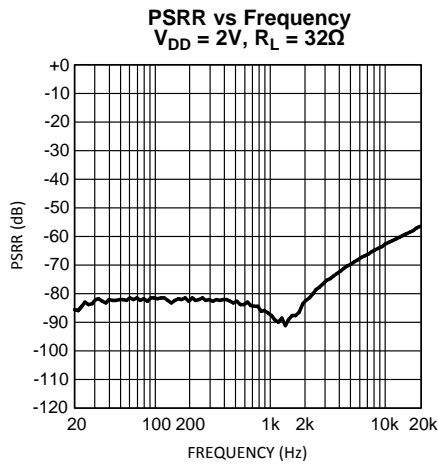

Figure 41.

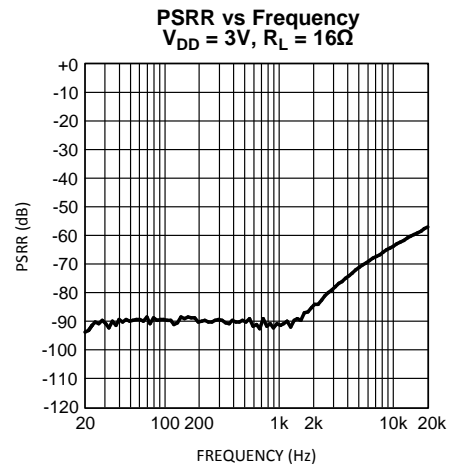

Figure 42.

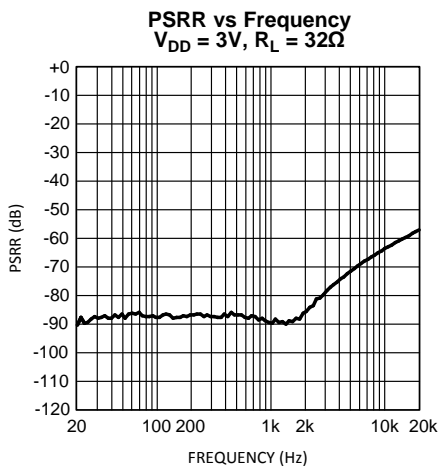

Figure 43.

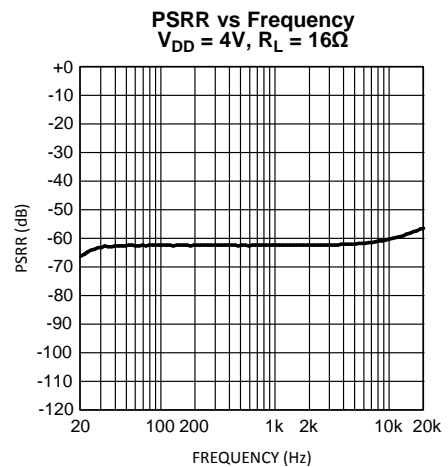

Figure 44.

Typical Performance Characteristics (continued)

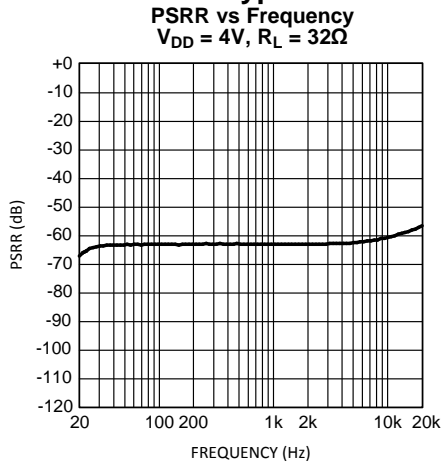

Figure 45.

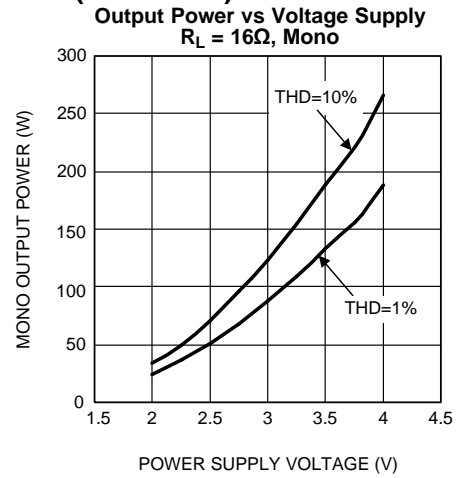

Figure 46.

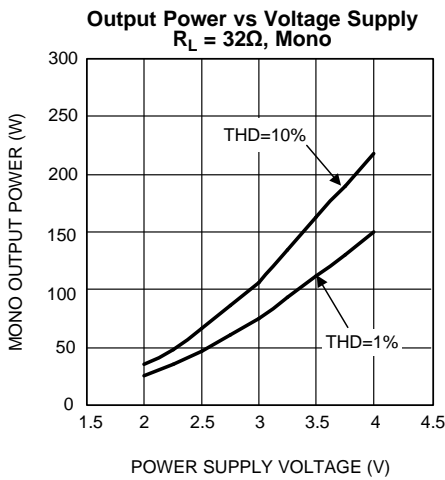

Figure 47.

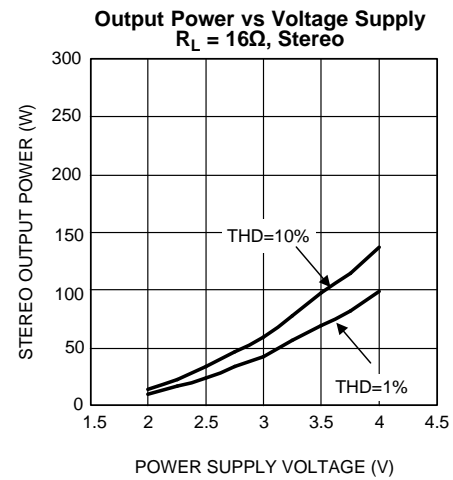

Figure 48.

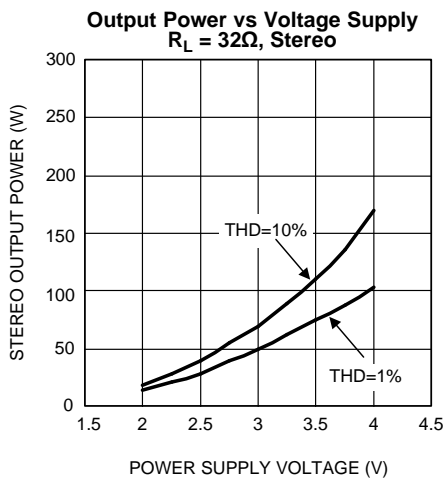

Figure 49.

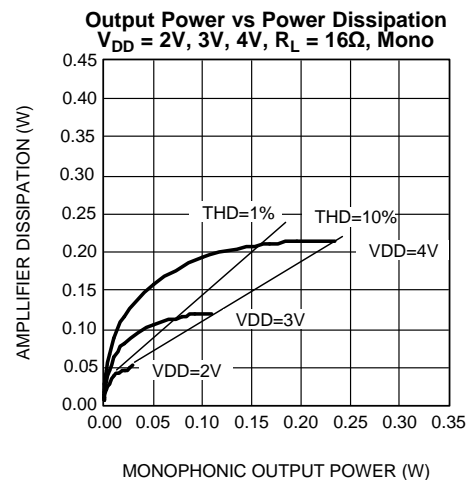

Figure 50.

Typical Performance Characteristics (continued)

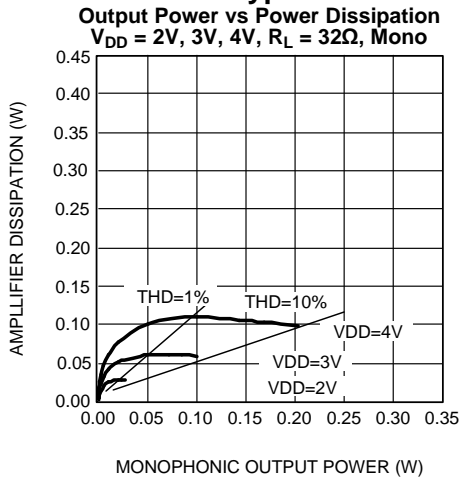

Figure 51.

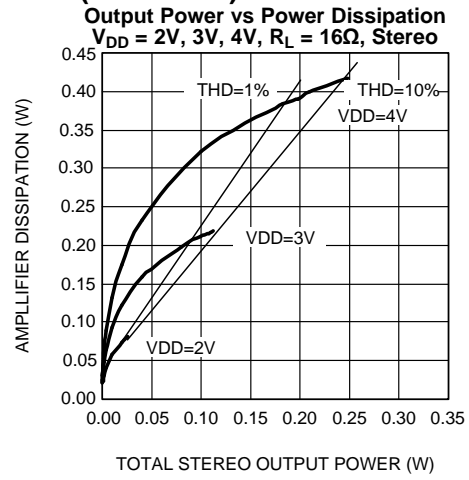

Figure 52.

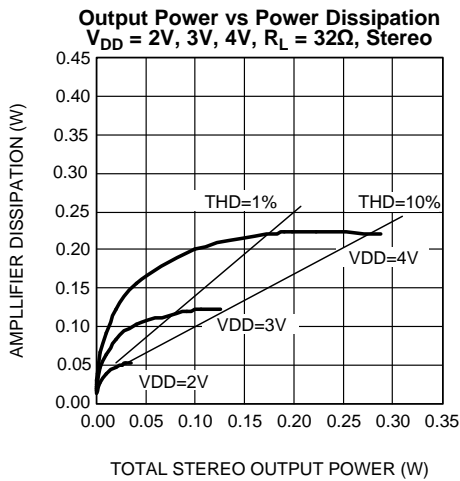

Figure 53.

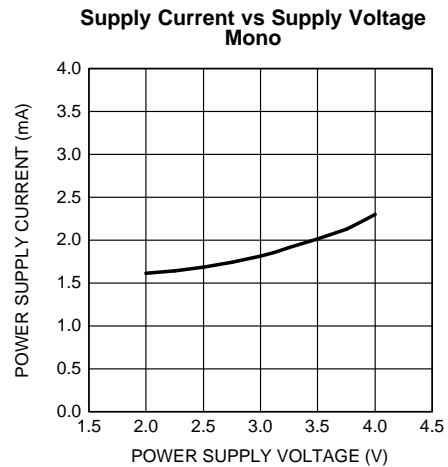

Figure 54.

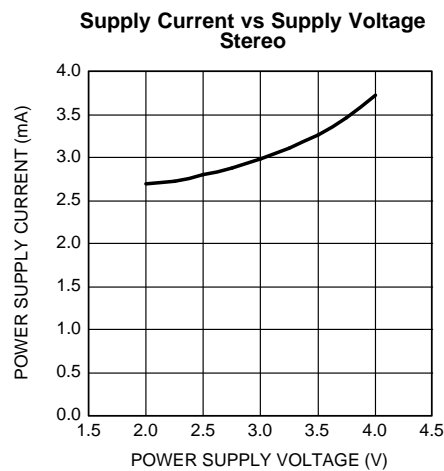

Figure 55.

APPLICATION INFORMATION

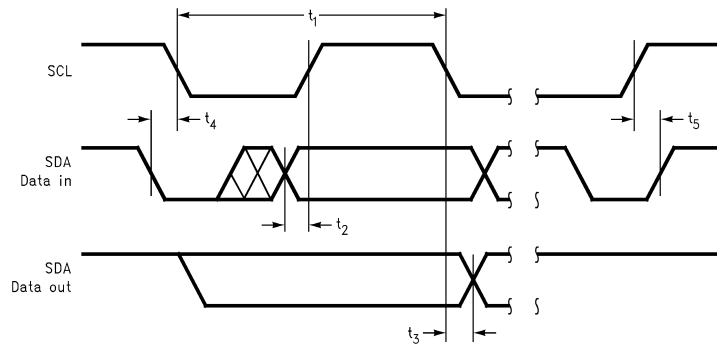

Figure 56. I²C Timing Diagram

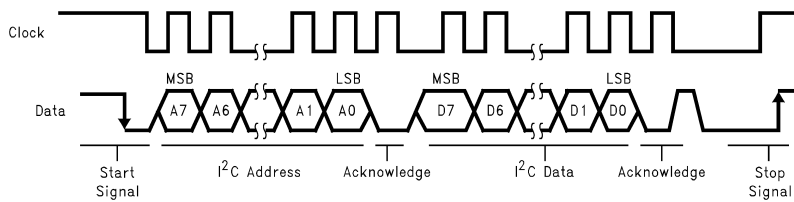

Figure 57. I²C Bus Format

Table 1. Chip Address

	D7	D6	D5	D4	D3	D2	D1	D0
Chip Address	1	1	1	0	1	1	0	0

Table 2. Control Registers

	D7	D6	D5	D4	D3	D2	D1	D0
Volume Control	VD4	VD3	VD2	VD1	VD0	MUTE	LF ENABLE	RT ENABLE

I²C VOLUME CONTROL

The LM48821 can be configured in 32 different gain steps by forcing I²C volume control bits to a desired gain according to [Table 3](#).

Table 3. Volume Control

VD4	VD3	VD2	VD1	VD0	Gain (dB)
0	0	0	0	0	-76
0	0	0	0	1	-62
0	0	0	1	0	-52
0	0	0	1	1	-44
0	0	1	0	0	-38
0	0	1	0	1	-34
0	0	1	1	0	-30
0	0	1	1	1	-27
0	1	0	0	0	-24
0	1	0	0	1	-21
0	1	0	1	0	-18
0	1	0	1	1	-16
0	1	1	0	0	-14
0	1	1	0	1	-12
0	1	1	1	0	-10
0	1	1	1	1	-8
1	0	0	0	0	-6
1	0	0	0	1	-4
1	0	0	1	0	-2
1	0	0	1	1	0
1	0	1	0	0	2
1	0	1	0	1	4
1	0	1	1	0	6
1	0	1	1	1	8
1	1	0	0	0	10
1	1	0	0	1	12
1	1	0	1	0	13
1	1	0	1	1	14
1	1	1	0	0	15
1	1	1	0	1	16
1	1	1	1	0	17
1	1	1	1	1	18

I²C COMPATIBLE INTERFACE

The LM48821 uses a serial data bus that conforms to the I²C protocol. Controlling the chip's functions is accomplished with two wires: serial clock (SCL) and serial data (SDA). The clock line is uni-directional. The data line is bi-directional (open-collector). The maximum clock frequency specified by the I²C standard is 400kHz. In this discussion, the master is the controlling microcontroller and the slave is the LM48821.

The bus format for the I²C interface is shown in [Figure 57](#). The bus format diagram is broken up into six major sections: The Start Signal, the I²C Address, an Acknowledge bit, the I²C data, second Acknowledge bit, and the Stop Signal.

The start signal is generated by lowering the data signal while the clock signal is high. The start signal will alert all devices attached to the I²C bus to check the incoming address against their own address.

The 8-bit chip address is sent next, most significant bit first. The data is latched in on the rising edge of the clock. Each address bit must be stable while the clock level is high.

After the last bit of the address bit is sent, the master releases the data line high (through a pull-up resistor). Then the master sends an acknowledge clock pulse. If the LM48821 has received the address correctly, then it holds the data line low during the clock pulse. If the data line is not held low during the acknowledge clock pulse, then the master should abort the rest of the data transfer to the LM48821. The 8 bits of data are sent next, most significant bit first. Each data bit should be valid while the clock level is stable high.

After the data byte is sent, the master must check for another acknowledge to see if the LM48821 received the data.

If the master has more data bytes to send to the LM48821, then the master can repeat the previous two steps until all data bytes have been sent.

The stop signal ends the transfer. To signal stop, the data signal goes high while the clock signal is high. The data line should be held high when not in use.

The LM48821's I²C address is shown in [Table 1](#). The I²C data register and its control bit names are shown in [Table 2](#). The data values for the volume control are shown in [Table 3](#).

I²C INTERFACE POWER SUPPLY PIN (I²CV_{DD})

The LM48821's I²C interface is powered up through the I²CV_{DD} pin. The LM48821's I²C interface operates at a voltage level set by the I²CV_{DD} pin. This voltage can be independent from the main power supply pin (V_{DD}). This is ideal whenever logic levels for the I²C interface are dictated by a microcontroller or microprocessor that is operating at a lower supply voltage than the main battery of a portable system.

POWER SUPPLY BYPASSING

As with any power amplifier, proper supply bypassing is critical for low noise performance and high power supply rejection. Applications that employ a 3.3V voltage regulator typically use a 10μF in parallel with a 0.1μF filter capacitors to stabilize the regulator's output, reduce noise on the regulated supply lines, and improve the regulator's transient response. However, their presence does not eliminate the need for a local 1.0μF tantalum bypass capacitance connected between the LM48821's supply pins and ground. Keep the length of leads and traces that connect capacitors between the LM48821's power supply pins and ground as short as possible.

ELIMINATING THE OUTPUT COUPLING CAPACITOR

The LM48821 features a low noise inverting charge pump that generates an internal negative supply voltage. This allows the LM48821 to reference its amplifier outputs to ground instead of a half-supply voltage, like traditional capacitivel-coupled headphone amplifiers. Because there is no DC bias voltage associated with either stereo output, the large DC blocking capacitors (typically 220μF) are not necessary. The coupling capacitors are replaced by two, small ceramic charge pump capacitors, saving board space and cost.

Eliminating the output coupling capacitors also improves low frequency response. In traditional headphone amplifiers, the headphone impedance and the output capacitor form a high pass filter that not only blocks the DC component of the output, but also attenuates low frequencies, impacting the bass response. Because the LM48821 does not require the output coupling capacitors, the low frequency response of the device is not degraded.

In addition to eliminating the output coupling capacitors, the ground referenced output nearly doubles the output voltage swing and available dynamic range of the LM48821 when compared to a traditional capacitively-coupled output headphone amplifier operating from the same supply voltage.

OUTPUT TRANSIENT ELIMINATED

The LM48821 contains advanced circuitry that virtually eliminates output transients ('clicks' and 'pops'). This circuitry attenuates output transients when the supply voltage is first applied or when the part resumes operation after using the shutdown mode.

POWER DISSIPATION

Power dissipation is a major concern when using any power amplifier and must be thoroughly understood to ensure a successful design. Equation 1 states the maximum power dissipation point for a single-ended amplifier operating at a given supply voltage and driving a specified output load.

$$P_{\text{DMAX}} = (2V_{\text{DD}})^2 / (2\pi^2 R_L) \quad (1)$$

Since the LM48821 has two power amplifiers in one package, the maximum internal power dissipation point is twice that of the number which results from Equation 1. Even with large internal power dissipation, the LM48821 does not require heat sinking over a large range of ambient temperatures. The maximum power dissipation point obtained must not be greater than the power dissipation that results from Equation 2:

$$P_{DMAX} = (T_{JMAX} - T_A) / (\theta_{JA}) \quad (2)$$

For the DSBGA package, $\theta_{JA} = 105^\circ\text{C/W}$. $T_{JMAX} = 150^\circ\text{C}$ for the LM48821. Depending on the ambient temperature, T_A , of the system surroundings, Equation 2 can be used to find the maximum internal power dissipation supported by the IC packaging. If the result of Equation 1 is greater than that of Equation 2, then either the supply voltage must be decreased, the load impedance increased or T_A reduced. Power dissipation is a function of output power and thus, if typical operation is not around the maximum power dissipation point, the ambient temperature may be increased accordingly.

SELECTING EXTERNAL COMPONENTS

Optimizing the LM48821's performance requires properly selecting external components. Though the LM48821 operates well when using external components with wide tolerances, best performance is achieved by optimizing component values.

Charge Pump Capacitor Selection

Use low ESR (equivalent series resistance) (<100m Ω) ceramic capacitors with an X7R dielectric for best performance. Low ESR capacitors keep the charge pump output impedance to a minimum, extending the headroom on the negative supply. Higher ESR capacitors result in reduced output power from the audio amplifiers.

Charge pump load regulation and output impedance are affected by the value of the flying capacitor (connected between the C_{CP-} and C_{CP+} pins). A larger valued C_1 (up to 4.7 μF) improves load regulation and minimizes charge pump output resistance. Beyond 4.7 μF , the switch-on-resistance dominates the output impedance.

The output ripple is affected by the value and ESR of the output capacitor (connected between the V_{SS} and PGND pins). Larger capacitors reduce output ripple on the negative power supply. Lower ESR capacitors minimize the output ripple and reduce the output impedance of the charge pump.

The LM48821 charge pump design is optimized for 4.7 μF , low ESR, ceramic, flying, and output capacitors.

Power Supply Bypass Capacitor

For good THD+N and low noise performance and to ensure correct power-on behavior at the maximum allowed power supply voltage, a local 4.7 μF power supply bypass capacitor should be connected as physically closed as possible to the PV_{DD} pin.

Input Capacitor Value Selection

Amplifying the lowest audio frequencies requires high value input coupling capacitors (the 0.47 μF capacitors in Figure 1). A high value capacitor can be expensive and may compromise space efficiency in portable designs. In many cases, however, the speakers used in portable systems, whether internal or external, have little ability to reproduce signals below 150Hz. Applications using speakers with this limited frequency response reap little improvement by using high value input and output capacitors.

Besides affecting system cost and size, the input coupling capacitor value has an effect on the LM48821's click and pop performance. The magnitude of the pop is directly proportional to the input capacitor's size. Thus, pops can be minimized by selecting an input capacitor value that is no higher than necessary to meet the desired -3dB frequency.

The LM48821's nominal input resistance at full volume is 10k Ω and a minimum of 5k Ω . This input resistance and the input coupling capacitor value produce a -3dB high pass filter cutoff frequency that is found using Equation 3.

$$f_{-3dB} = 1/2\pi R_i C_i \quad (3)$$

REVISION HISTORY

Rev	Date	Description
1.0	06/06/07	Initial release.
A	05/02/2013	Changed layout of National Data Sheet to TI format.

PACKAGING INFORMATION

Orderable Device	Status (1)	Package Type	Package Drawing	Pins	Package Qty	Eco Plan (2)	Lead/Ball Finish	MSL Peak Temp (3)	Op Temp (°C)	Top-Side Markings (4)	Samples
LM48821TL/NOPB	ACTIVE	DSBGA	YZR	16	250	Green (RoHS & no Sb/Br)	SNAGCU	Level-1-260C-UNLIM	-40 to 85	G16	Samples
LM48821TLX/NOPB	ACTIVE	DSBGA	YZR	16	3000	Green (RoHS & no Sb/Br)	SNAGCU	Level-1-260C-UNLIM	-40 to 85	G16	Samples

(1) The marketing status values are defined as follows:

ACTIVE: Product device recommended for new designs.

LIFEBUY: TI has announced that the device will be discontinued, and a lifetime-buy period is in effect.

NRND: Not recommended for new designs. Device is in production to support existing customers, but TI does not recommend using this part in a new design.

PREVIEW: Device has been announced but is not in production. Samples may or may not be available.

OBSOLETE: TI has discontinued the production of the device.

(2) Eco Plan - The planned eco-friendly classification: Pb-Free (RoHS), Pb-Free (RoHS Exempt), or Green (RoHS & no Sb/Br) - please check <http://www.ti.com/productcontent> for the latest availability information and additional product content details.

TBD: The Pb-Free/Green conversion plan has not been defined.

Pb-Free (RoHS): TI's terms "Lead-Free" or "Pb-Free" mean semiconductor products that are compatible with the current RoHS requirements for all 6 substances, including the requirement that lead not exceed 0.1% by weight in homogeneous materials. Where designed to be soldered at high temperatures, TI Pb-Free products are suitable for use in specified lead-free processes.

Pb-Free (RoHS Exempt): This component has a RoHS exemption for either 1) lead-based flip-chip solder bumps used between the die and package, or 2) lead-based die adhesive used between the die and leadframe. The component is otherwise considered Pb-Free (RoHS compatible) as defined above.

Green (RoHS & no Sb/Br): TI defines "Green" to mean Pb-Free (RoHS compatible), and free of Bromine (Br) and Antimony (Sb) based flame retardants (Br or Sb do not exceed 0.1% by weight in homogeneous material)

(3) MSL, Peak Temp. -- The Moisture Sensitivity Level rating according to the JEDEC industry standard classifications, and peak solder temperature.

(4) Multiple Top-Side Markings will be inside parentheses. Only one Top-Side Marking contained in parentheses and separated by a "~" will appear on a device. If a line is indented then it is a continuation of the previous line and the two combined represent the entire Top-Side Marking for that device.

Important Information and Disclaimer: The information provided on this page represents TI's knowledge and belief as of the date that it is provided. TI bases its knowledge and belief on information provided by third parties, and makes no representation or warranty as to the accuracy of such information. Efforts are underway to better integrate information from third parties. TI has taken and continues to take reasonable steps to provide representative and accurate information but may not have conducted destructive testing or chemical analysis on incoming materials and chemicals. TI and TI suppliers consider certain information to be proprietary, and thus CAS numbers and other limited information may not be available for release.

In no event shall TI's liability arising out of such information exceed the total purchase price of the TI part(s) at issue in this document sold by TI to Customer on an annual basis.

TAPE AND REEL INFORMATION



QUADRANT ASSIGNMENTS FOR PIN 1 ORIENTATION IN TAPE



*All dimensions are nominal

Device	Package Type	Package Drawing	Pins	SPQ	Reel Diameter (mm)	Reel Width W1 (mm)	A0 (mm)	B0 (mm)	K0 (mm)	P1 (mm)	W (mm)	Pin1 Quadrant
LM48821TL/NOPB	DSBGA	YZR	16	250	178.0	8.4	2.08	2.08	0.76	4.0	8.0	Q1
LM48821TLX/NOPB	DSBGA	YZR	16	3000	178.0	8.4	2.08	2.08	0.76	4.0	8.0	Q1

TAPE AND REEL BOX DIMENSIONS



*All dimensions are nominal

Device	Package Type	Package Drawing	Pins	SPQ	Length (mm)	Width (mm)	Height (mm)
LM48821TL/NOPB	DSBGA	YZR	16	250	210.0	185.0	35.0
LM48821TLX/NOPB	DSBGA	YZR	16	3000	210.0	185.0	35.0

YZR0016

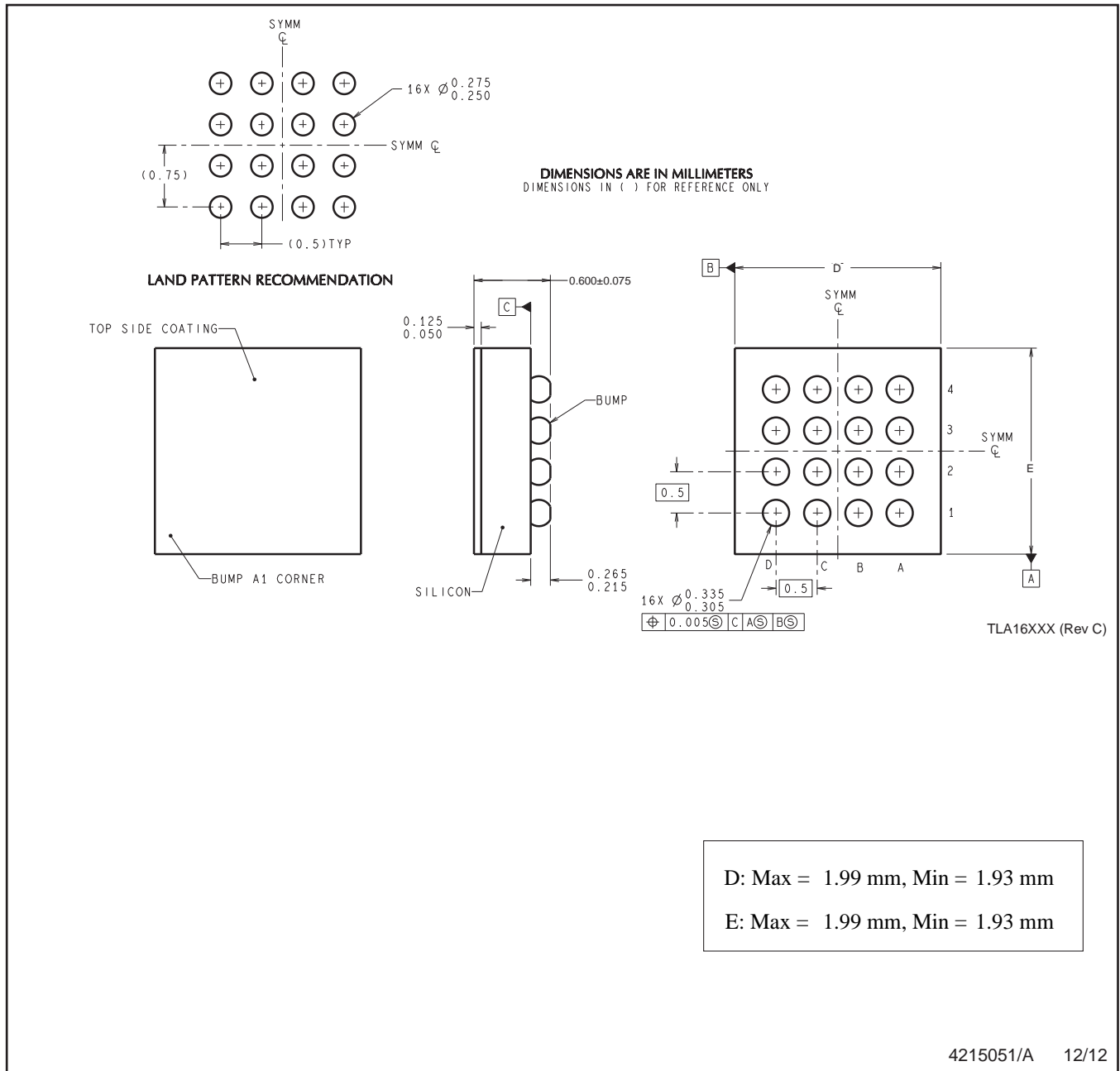

D: Max = 1.99 mm, Min = 1.93 mm
 E: Max = 1.99 mm, Min = 1.93 mm

4215051/A 12/12

NOTES: A. All linear dimensions are in millimeters. Dimensioning and tolerancing per ASME Y14.5M-1994.
 B. This drawing is subject to change without notice.

IMPORTANT NOTICE

Texas Instruments Incorporated and its subsidiaries (TI) reserve the right to make corrections, enhancements, improvements and other changes to its semiconductor products and services per JESD46, latest issue, and to discontinue any product or service per JESD48, latest issue. Buyers should obtain the latest relevant information before placing orders and should verify that such information is current and complete. All semiconductor products (also referred to herein as "components") are sold subject to TI's terms and conditions of sale supplied at the time of order acknowledgment.

TI warrants performance of its components to the specifications applicable at the time of sale, in accordance with the warranty in TI's terms and conditions of sale of semiconductor products. Testing and other quality control techniques are used to the extent TI deems necessary to support this warranty. Except where mandated by applicable law, testing of all parameters of each component is not necessarily performed.

TI assumes no liability for applications assistance or the design of Buyers' products. Buyers are responsible for their products and applications using TI components. To minimize the risks associated with Buyers' products and applications, Buyers should provide adequate design and operating safeguards.

TI does not warrant or represent that any license, either express or implied, is granted under any patent right, copyright, mask work right, or other intellectual property right relating to any combination, machine, or process in which TI components or services are used. Information published by TI regarding third-party products or services does not constitute a license to use such products or services or a warranty or endorsement thereof. Use of such information may require a license from a third party under the patents or other intellectual property of the third party, or a license from TI under the patents or other intellectual property of TI.

Reproduction of significant portions of TI information in TI data books or data sheets is permissible only if reproduction is without alteration and is accompanied by all associated warranties, conditions, limitations, and notices. TI is not responsible or liable for such altered documentation. Information of third parties may be subject to additional restrictions.

Resale of TI components or services with statements different from or beyond the parameters stated by TI for that component or service voids all express and any implied warranties for the associated TI component or service and is an unfair and deceptive business practice. TI is not responsible or liable for any such statements.

Buyer acknowledges and agrees that it is solely responsible for compliance with all legal, regulatory and safety-related requirements concerning its products, and any use of TI components in its applications, notwithstanding any applications-related information or support that may be provided by TI. Buyer represents and agrees that it has all the necessary expertise to create and implement safeguards which anticipate dangerous consequences of failures, monitor failures and their consequences, lessen the likelihood of failures that might cause harm and take appropriate remedial actions. Buyer will fully indemnify TI and its representatives against any damages arising out of the use of any TI components in safety-critical applications.

In some cases, TI components may be promoted specifically to facilitate safety-related applications. With such components, TI's goal is to help enable customers to design and create their own end-product solutions that meet applicable functional safety standards and requirements. Nonetheless, such components are subject to these terms.

No TI components are authorized for use in FDA Class III (or similar life-critical medical equipment) unless authorized officers of the parties have executed a special agreement specifically governing such use.

Only those TI components which TI has specifically designated as military grade or "enhanced plastic" are designed and intended for use in military/aerospace applications or environments. Buyer acknowledges and agrees that any military or aerospace use of TI components which have **not** been so designated is solely at the Buyer's risk, and that Buyer is solely responsible for compliance with all legal and regulatory requirements in connection with such use.

TI has specifically designated certain components as meeting ISO/TS16949 requirements, mainly for automotive use. In any case of use of non-designated products, TI will not be responsible for any failure to meet ISO/TS16949.

Products

Audio	www.ti.com/audio
Amplifiers	amplifier.ti.com
Data Converters	dataconverter.ti.com
DLP® Products	www.dlp.com
DSP	dsp.ti.com
Clocks and Timers	www.ti.com/clocks
Interface	interface.ti.com
Logic	logic.ti.com
Power Mgmt	power.ti.com
Microcontrollers	microcontroller.ti.com
RFID	www.ti-rfid.com
OMAP Applications Processors	www.ti.com/omap
Wireless Connectivity	www.ti.com/wirelessconnectivity

Applications

Automotive and Transportation	www.ti.com/automotive
Communications and Telecom	www.ti.com/communications
Computers and Peripherals	www.ti.com/computers
Consumer Electronics	www.ti.com/consumer-apps
Energy and Lighting	www.ti.com/energy
Industrial	www.ti.com/industrial
Medical	www.ti.com/medical
Security	www.ti.com/security
Space, Avionics and Defense	www.ti.com/space-avionics-defense
Video and Imaging	www.ti.com/video

TI E2E Community

e2e.ti.com