

LME49713 High Performance, High Fidelity Current Feedback Audio Operational Amplifier

Check for Samples: [LME49713](#)

FEATURES

- Easily Drives 150Ω Loads
- Optimized for Superior Audio Signal Fidelity
- Output Short Circuit Protection
- 100dB (Typ) PSRR and 88dB (Typ) CMRR
- SOIC High-Performance and TO-99 Packages

APPLICATIONS

- Ultra High Quality Audio Amplification
- High-Fidelity Preamplifiers
- High-Fidelity Multimedia
- State-of-the-Art Phono Pre Amps
- High-Performance Professional Audio
- High-Fidelity Equalization and Crossover Networks
- High-Performance Line Drivers
- High-Performance Line Receivers
- High-Fidelity Active Filters

KEY SPECIFICATIONS

- Power Supply Voltage Range: $\pm 5V$ to $\pm 18V$
- THD+N, $f = 1\text{kHz}$ ($A_V = 1$, $R_L = 100\Omega$, $V_{OUT} = 3V_{RMS}$): 0.0006% (typ)
- THD+N, $f = 1\text{kHz}$ ($A_V = 1$, $R_L = 600\Omega$, $V_{OUT} = 1.4V_{RMS}$): 0.00036% (typ)
- Input Noise Density: $1.9\text{nV}/\sqrt{\text{Hz}}$ (typ)
- Slew Rate: $\pm 1900\text{V}/\mu\text{s}$ (typ)
- Bandwidth ($A_V = -1$, $R_L = 2\text{k}\Omega$, $R_F = 1.2\text{k}\Omega$): 132 MHz (typ)
- Input Bias Current: $1.8\mu\text{A}$ (typ)
- Input Offset Voltage: 0.05mV (typ)

DESCRIPTION

The LME49713 is an ultra-low distortion, low noise, ultra high slew rate current feedback operational amplifier optimized and fully specified for high performance, high fidelity applications. Combining advanced leading-edge process technology with state-of-the-art circuit design, the LME49713 current feedback operational amplifier delivers superior signal amplification for outstanding performance. Operating on a wide supply range of $\pm 5V$ to $\pm 18V$, the LME49713 combines extremely low voltage noise density ($1.9\text{nV}/\sqrt{\text{Hz}}$) with very low THD+N (0.00036%) to easily satisfy the most demanding applications. To ensure that the most challenging loads are driven without compromise, the LME49713 has a high slew rate of $\pm 1900\text{V}/\mu\text{s}$ and an output current capability of $\pm 100\text{mA}$. Further, dynamic range is maximized by an output stage that drives 150Ω loads to within 2.9V of either power supply voltage.

The LME49713's outstanding CMRR (88dB), PSRR (100dB), and V_{OS} (0.05mV) give the amplifier excellent operational amplifier DC performance.

The LME49713 is available in an 8-lead narrow body SOIC and an 8-lead TO-99. Demonstration boards are available.



Please be aware that an important notice concerning availability, standard warranty, and use in critical applications of Texas Instruments semiconductor products and disclaimers thereto appears at the end of this data sheet.

All trademarks are the property of their respective owners.

CONNECTION DIAGRAMS

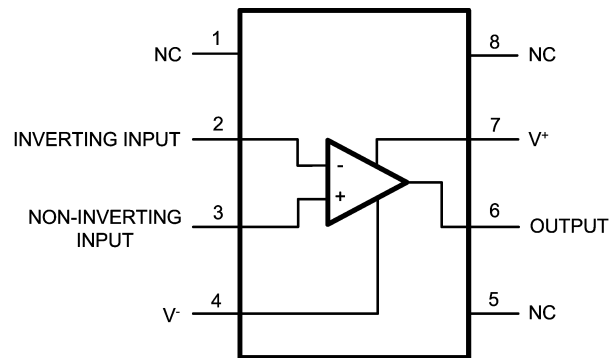

**Figure 1. 8-Lead SOIC
(D Package)**

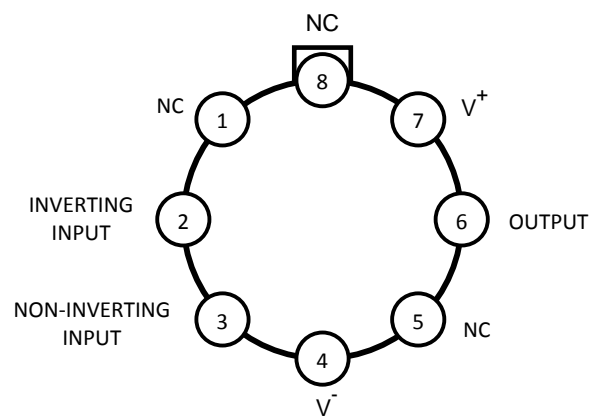

**Figure 2. 8-Lead TO-99
(LMC Package)**



These devices have limited built-in ESD protection. The leads should be shorted together or the device placed in conductive foam during storage or handling to prevent electrostatic damage to the MOS gates.

ABSOLUTE MAXIMUM RATINGS⁽¹⁾⁽²⁾⁽³⁾

Power Supply Voltage ($V_S = V^+ - V^-$)	38V
Storage Temperature	-65°C to 150°C
Input Voltage	(V-) - 0.7V to (V+) + 0.7V
Output Short Circuit ⁽⁴⁾	Continuous
Power Dissipation	Internally Limited
ESD Rating ⁽⁵⁾	2000V
ESD Rating ⁽⁶⁾	200V
Junction Temperature	150°C
Thermal Resistance	
θ_{JA} (MA)	145°C/W
Temperature Range	
$T_{MIN} \leq T_A \leq T_{MAX}$	-40°C \leq T _J \leq 70°C
Supply Voltage Range	$\pm 5.0V \leq V_S \leq \pm 18V$

- (1) *Absolute Maximum Ratings* indicate limits beyond which damage to the device may occur, including inoperability and degradation of device reliability and/or performance. Functional operation of the device and/or non-degradation at the *Absolute Maximum Ratings* or other conditions beyond those indicated in the *Recommended Operating Conditions* is not implied. The *Recommended Operating Conditions* indicate conditions at which the device is functional and the device should not be operated beyond such conditions. All voltages are measured with respect to the ground pin, unless otherwise specified.
- (2) The *Electrical Characteristics* tables list ensured specifications under the listed *Recommended Operating Conditions* except as otherwise modified or specified by the *Electrical Characteristics Conditions* and/or Notes. Typical specifications are estimations only and are not ensured.
- (3) If Military/Aerospace specified devices are required, please contact the Texas Instruments Sales Office/Distributors for availability and specifications.
- (4) Amplifier output connected to GND, any number of amplifiers within a package.
- (5) Human body model, applicable std. JESD22-A114C.
- (6) Machine model, applicable std. JESD22-A115-A.

ELECTRICAL CHARACTERISTICS⁽¹⁾⁽²⁾

The following specifications apply for the $V_S = \pm 15V$, $R_L = 2k\Omega$, $R_{SOURCE} = 10\Omega$, $f_{IN} = 1kHz$, and $T_J = 25^\circ C$, unless otherwise specified.

Symbol	Parameter	Conditions	LME49713		Units (Limits)
			Typical ⁽³⁾	Limit ⁽⁴⁾	
THD+N	Total Harmonic Distortion + Noise	$A_V = 1$, $V_{OUT} = 3V_{RMS}$, $R_F = 1.2k\Omega$ $R_L = 100\Omega$, $V_{OUT} = 3V_{RMS}$ $R_L = 600\Omega$, $V_{OUT} = 1.4V_{RMS}$	0.0006 0.00036	0.00071 0.00045	% (max) % (max)
IMD	Intermodulation Distortion	$A_V = 1$, $V_{IN} = 3V_{RMS}$ Two-tone, 60Hz & 7kHz 4:1	0.00009		%
BW	Bandwidth	$A_V = -1$, $R_F = 1.2k\Omega$	132		MHz
SR	Slew Rate	$V_O = 20V_{P-P}$, $A_V = -1$	± 1900		V/ μs
FPBW	Full Power Bandwidth	$V_{OUT} = 20V_{P-P}$, $A_V = -1$	30		MHz
t_s	Settling time	$A_V = -1$, 10V step, 0.1% error range	50		ns
e_n	Equivalent Input Noise Voltage	$f_{BW} = 20Hz$ to 20kHz	0.26	0.6	μV_{RMS} (max)
	Equivalent Input Noise Density	$f = 1kHz$ $f = 10Hz$	1.9 11.5	4.0	nV/ \sqrt{Hz} (max)
i_n	Current Noise Density	$f = 1kHz$ $f = 10Hz$	16 160		pA/ \sqrt{Hz}
V_{OS}	Input Offset Voltage		± 0.05	± 1.0	mV (max)
$\Delta V_{OS}/\Delta Temp$	Average Input Offset Voltage Drift vs Temperature	$-40^\circ C \leq T_A \leq 85^\circ C$	0.29		$\mu V/^\circ C$
PSRR	Average Input Offset Voltage Shift vs Power Supply Voltage	$V_{SUPPLY} = \pm 5V$ to $\pm 15V$ ⁽⁵⁾	100	95	dB (min)
I_B	Input Bias Current	$V_{CM} = 0V$	1.8	6	μA (max)
$\Delta I_{OS}/\Delta Temp$	Input Bias Current Drift vs Temperature	$-40^\circ C \leq T_A \leq 85^\circ C$ Inverting input Non-inverting input	4.5 4.7		nA/ $^\circ C$ nA/ $^\circ C$
I_{OS}	Input Offset Current	$V_{CM} = 0V$	1.3	5	μA (max)
V_{IN-CM}	Common-Mode Input Voltage Range		± 13.5	(V+) – 2.0 (V-) + 2.0	V (min) V (min)
CMRR	Common-Mode Rejection	$-10V < V_{cm} < 10V$	88	86	dB (min)
Z_{IN}	Non-inverting-input Input Impedance	$-10V < V_{cm} < 10V$	1.2		M Ω
	Inverting-input Input Impedance	$-10V < V_{cm} < 10V$	58		Ω
Z_T	Transimpedance	$V_{OUT} = \pm 10V$			
		$R_L = 200\Omega$	4.2	2.0	M Ω (min)
		$R_L = \infty$	4.7	2.65	M Ω (min)
V_{OUTMAX}	Maximum Output Voltage Swing	$R_L = 150\Omega$	± 11.1	± 10.3	V (min)
		$R_L = 600\Omega$	± 11.6	± 11.4	V (min)
I_{OUT}	Output Current	$R_L = 150\Omega$, $V_S = \pm 18V$	± 100	± 91	mA (min)
I_{OUT-CC}	Instantaneous Short Circuit Current		± 140		mA
R_{OUT}	Output Resistance	$f_{IN} = 5MHz$, Open-Loop	10		Ω
I_S	Total Quiescent Current	$I_{OUT} = 0mA$	8.5	10	mA (max)

- (1) *Absolute Maximum Ratings* indicate limits beyond which damage to the device may occur, including inoperability and degradation of device reliability and/or performance. Functional operation of the device and/or non-degradation at the *Absolute Maximum Ratings* or other conditions beyond those indicated in the *Recommended Operating Conditions* is not implied. The *Recommended Operating Conditions* indicate conditions at which the device is functional and the device should not be operated beyond such conditions. All voltages are measured with respect to the ground pin, unless otherwise specified.
- (2) The *Electrical Characteristics* tables list ensured specifications under the listed *Recommended Operating Conditions* except as otherwise modified or specified by the *Electrical Characteristics Conditions* and/or Notes. Typical specifications are estimations only and are not ensured.
- (3) Typical values represent most likely parametric norms at $T_A = +25^\circ C$, and at the *Recommended Operation Conditions* at the time of product characterization and are not ensured.
- (4) Datasheet min/max specification limits are specified by test or statistical analysis.
- (5) PSRR is measured as follows: V_{OS} is measured at two supply voltages, $\pm 5V$ and $\pm 15V$. $PSRR = |20\log(\Delta V_{OS}/\Delta V_S)|$.

TYPICAL PERFORMANCE CHARACTERISTICS

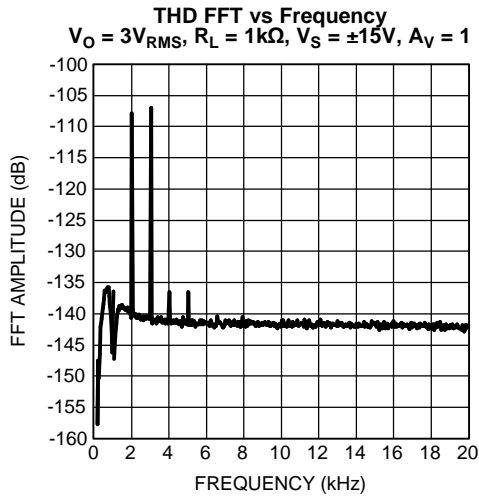

Figure 3.

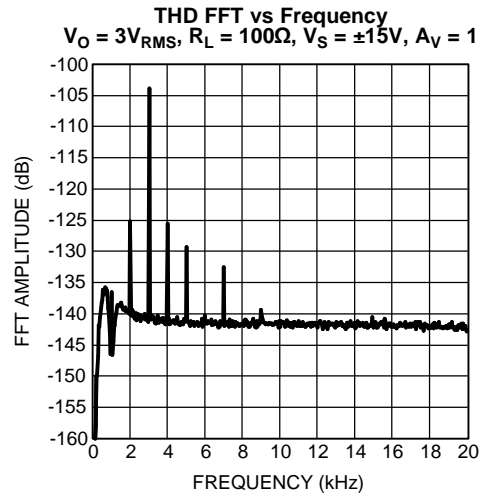

Figure 4.

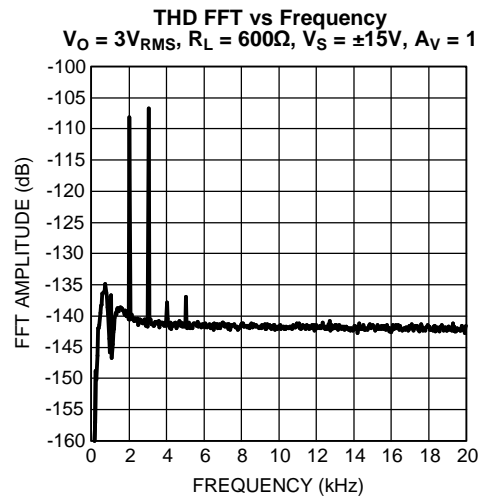

Figure 5.

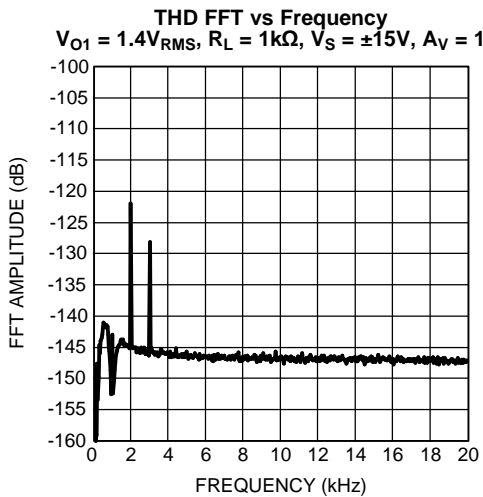

Figure 6.

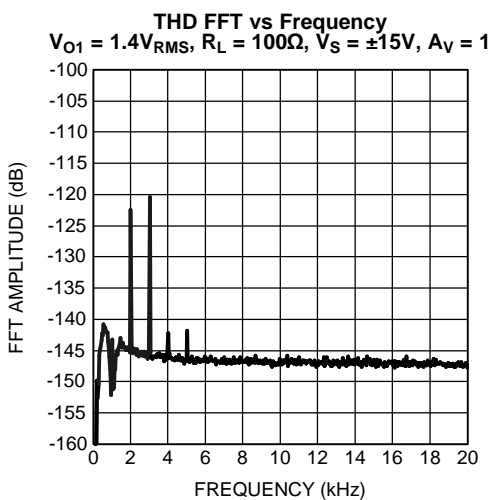

Figure 7.

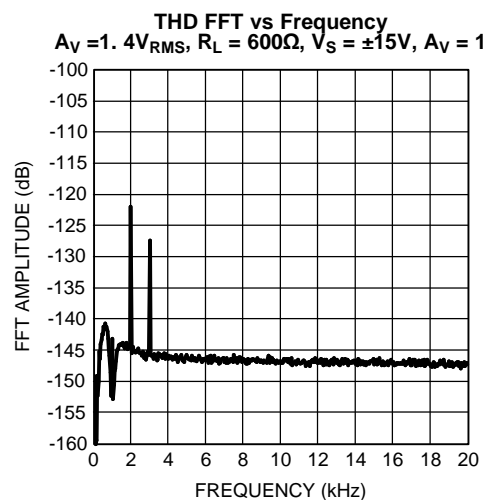

Figure 8.

TYPICAL PERFORMANCE CHARACTERISTICS (continued)

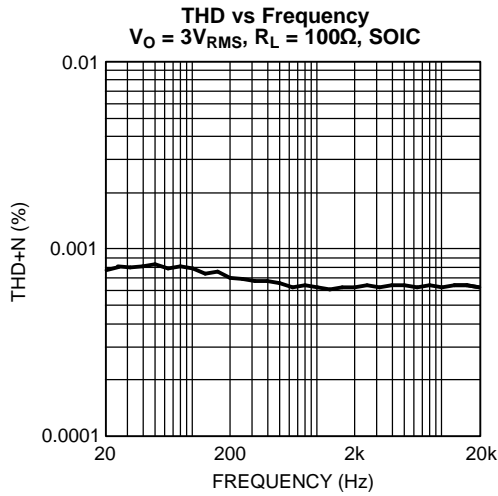

Figure 9.

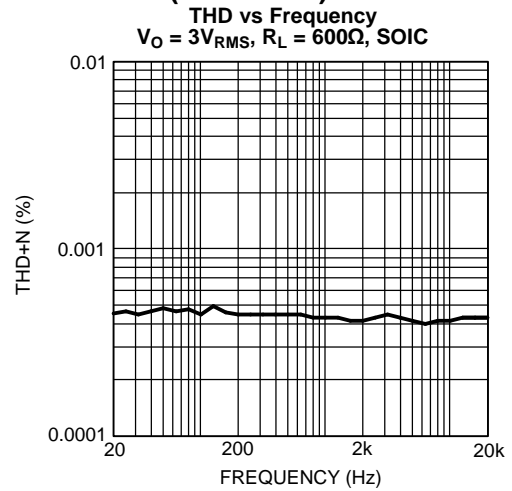

Figure 10.

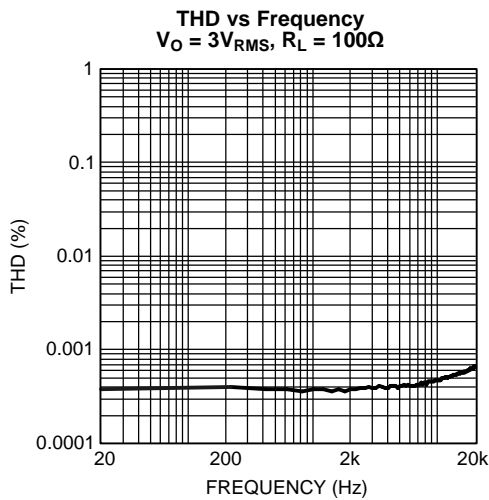

Figure 11.

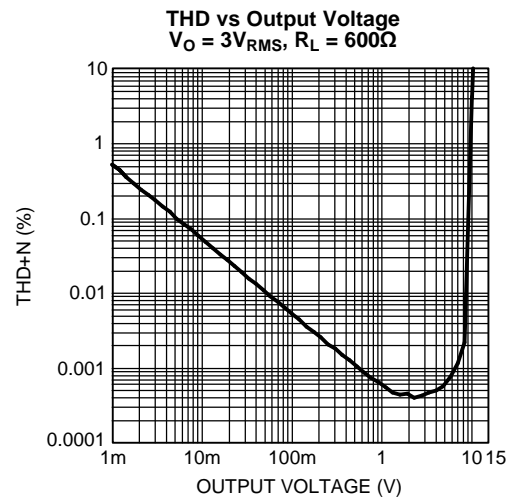

Figure 12.

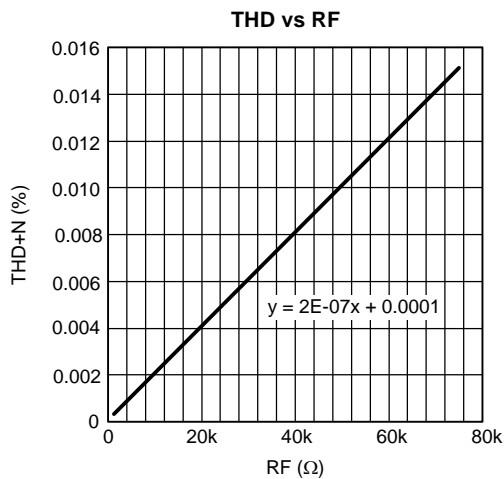

Figure 13.

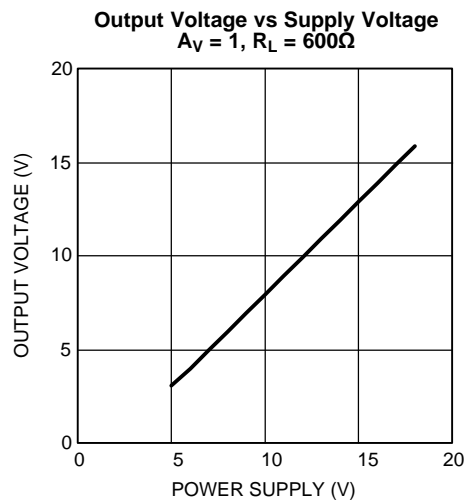

Figure 14.

TYPICAL PERFORMANCE CHARACTERISTICS (continued)

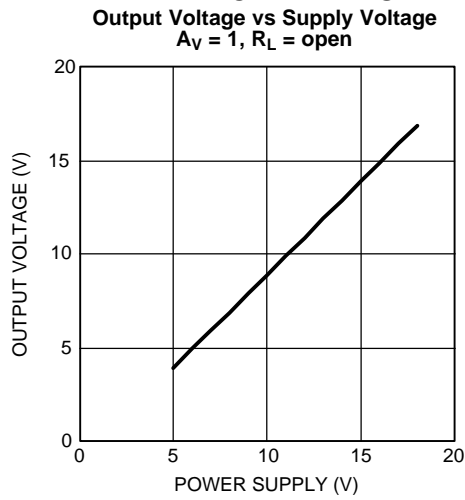

Figure 15.

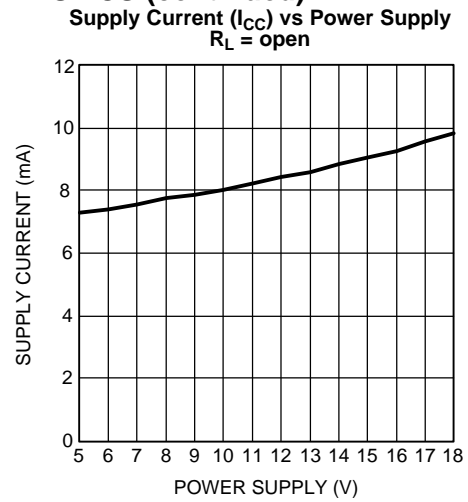

Figure 16.

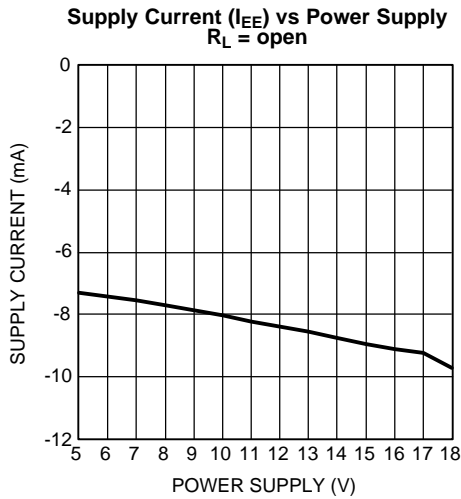

Figure 17.

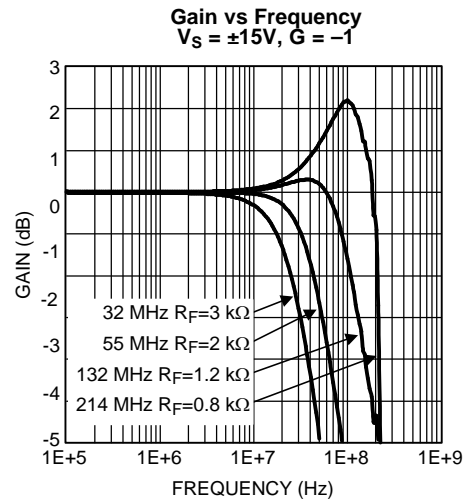

Figure 18.

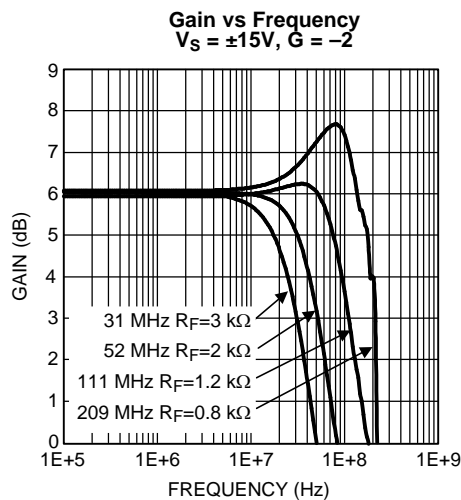

Figure 19.

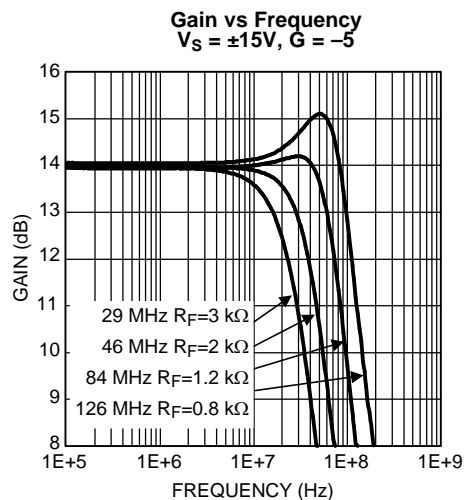

Figure 20.

TYPICAL PERFORMANCE CHARACTERISTICS (continued)

Gain vs Frequency
 $V_S = \pm 15V, G = -10$

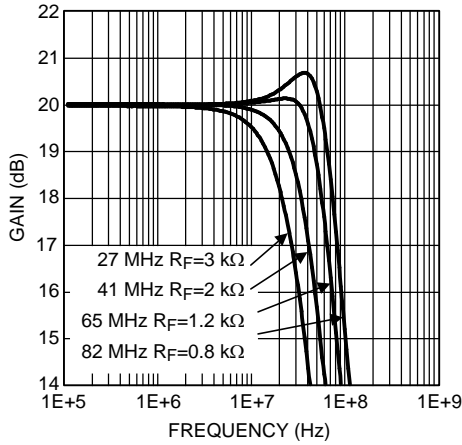

Figure 21.

Gain vs Frequency
 $R_F = 800\Omega, V_S = \pm 15V$

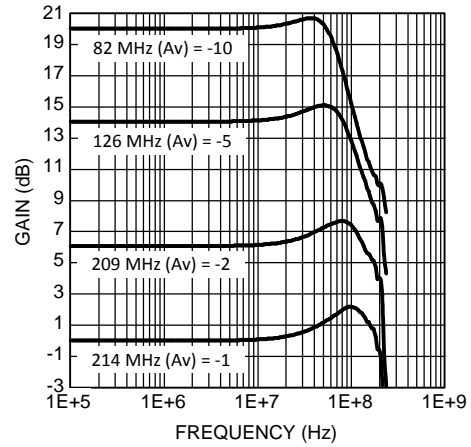

Figure 22.

Gain vs Frequency
 $R_F = 1.2k\Omega, V_S = \pm 15V$

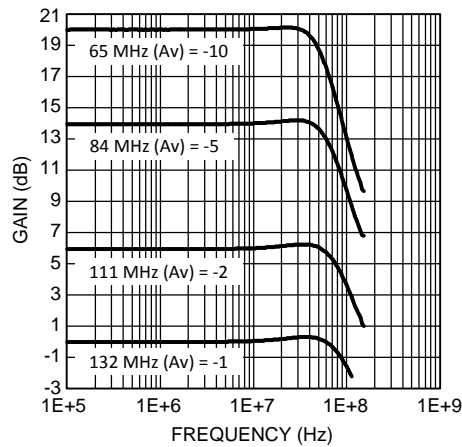

Figure 23.

Gain vs Frequency
 $R_F = 2k\Omega, V_S = \pm 15V$

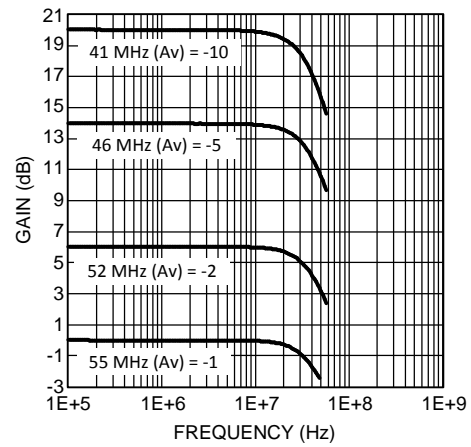

Figure 24.

Gain vs Frequency
 $R_F = 3k\Omega, V_S = \pm 15V$

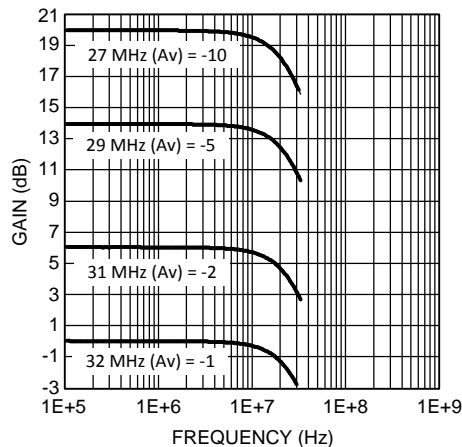

Figure 25.

CMRR vs Frequency
 $V_S = \pm 15V$

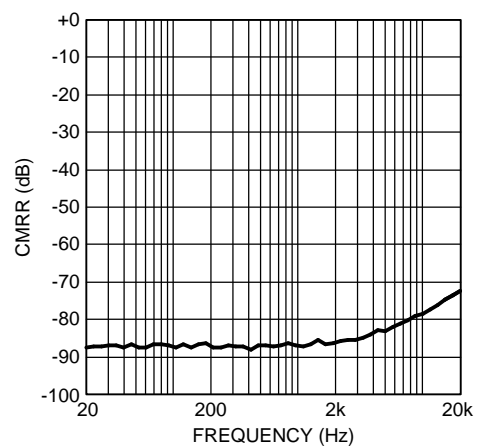

Figure 26.

TYPICAL PERFORMANCE CHARACTERISTICS (continued)

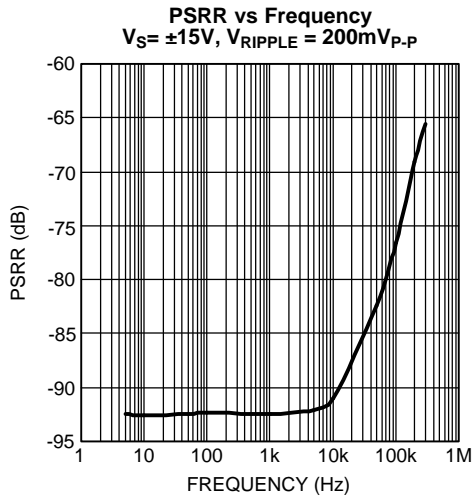

Figure 27.

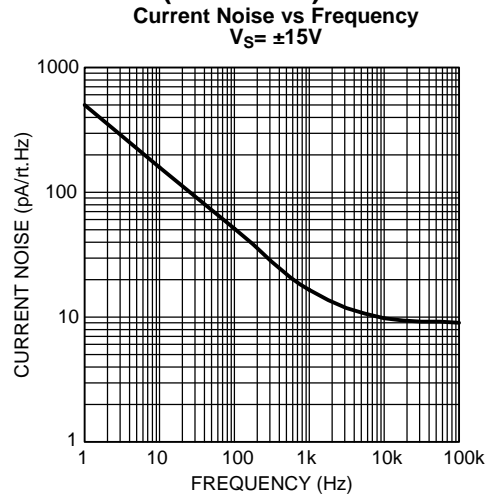

Figure 28.

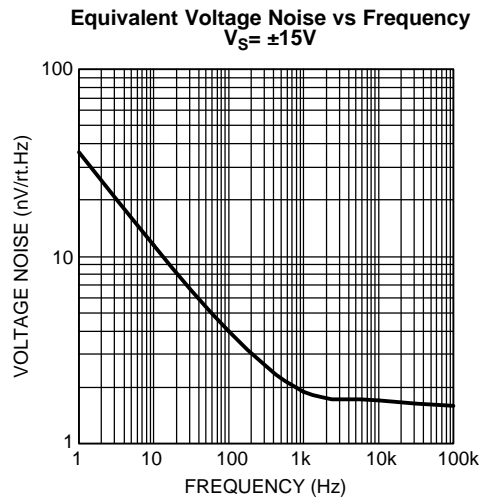

Figure 29.

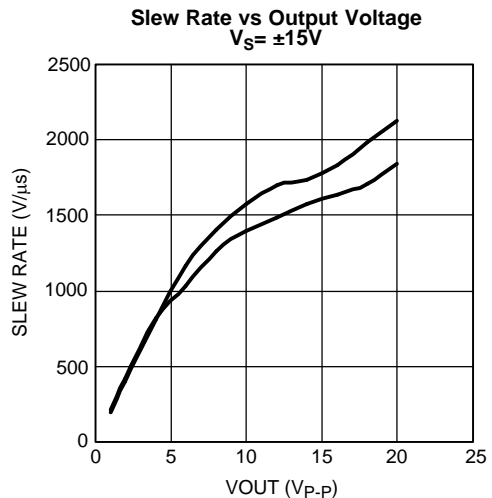

Figure 30.

APPLICATION INFORMATION

GENERAL AMPLIFIER FUNCTION

Voltage feedback amplifiers have a small-signal bandwidth that is a function of the closed-loop gain. Conversely, the LME49713 current feedback amplifier features a small-signal bandwidth that is relatively independent of the closed-loop gain. This is shown in [Figure 31](#) where the LME49713's gain is -1 , -2 , -5 , and -10 . Like all current feedback amplifiers, the LME49713's closed-loop bandwidth is a function of the feedback resistance value. Therefore, R_s must be varied to select the desired closed-loop gain.

POWER SUPPLY BYPASSING AND LAYOUT CONSIDERATIONS

Properly placed and correctly valued supply bypassing is essential for optimized high-speed amplifier operation. The supply bypassing must maintain a wideband, low-impedance capacitive connection between the amplifier's supply pin and ground. This helps preserve high speed signal and fast transient fidelity. The bypassing is easily accomplished using a parallel combination of a $10\mu\text{F}$ tantalum and a $0.1\mu\text{F}$ ceramic capacitors for each power supply pin. The bypass capacitors should be placed as close to the amplifier power supply pins as possible.

FEEDBACK RESISTOR SELECTION (R_f)

The value of the R_f is also a dominant factor in compensating the LME49713. For general applications, the LME49713 will maintain specified performance with an $1.2\text{k}\Omega$ feedback resistor. Although this value will provide good results for most applications, it may be advantageous to adjust this value slightly for best pulse response optimized for the desired bandwidth. In addition to reducing bandwidth, increasing the feedback resistor value also reduces overshoot in the time domain response.

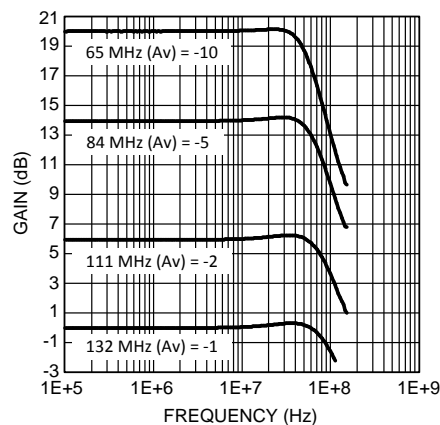

Figure 31. Bandwidth as a Function of Gain

SLEW RATE CONSIDERATIONS

A current feedback amplifier's slew rate characteristics are different than that of voltage feedback amplifiers. A voltage feedback amplifier's slew rate limiting or non-linear amplifier behavior is dominated by the finite availability of the first stage tail current charging the second stage voltage amplifier's compensation capacitor. Conversely, a current feedback amplifier's slew rate is not constant. Transient current at the inverting input determines slew rate for both inverting and non-inverting gains. The non-inverting configuration slew rate is also determined by input stage limitations. Accordingly, variations of slew rates occur for different circuit topologies.

DRIVING CAPACITIVE LOADS

The LME49713 can drive significantly higher capacitive loads than many current feedback amplifiers. Although the LME49713 can directly drive as much as 100pF without oscillating, the resulting response will be a function of the feedback resistor value.

CAPACITIVE FEEDBACK

It is quite common to place a small lead-compensation capacitor in parallel with a voltage feedback amplifier's feedback resistance, R_f . This compensation reduces the amplifier's peaking in the frequency domain and damps the transient response. Whereas this yields the expected results when used with voltage feedback amplifiers, this technique must not be used with current feedback amplifiers. The dynamic impedance of capacitors in the feedback loop reduces the amplifier's stability. Instead, reduced peaking in the frequency response and bandwidth limiting can be accomplished by adding an RC circuit to the amplifier's input.

REVISION HISTORY

Revision	Date	Description
1.0	09/26/07	Initial release.
1.1	09/28/07	Added the Typical Performance curves.
1.2	10/03/07	Input Limit values.
1.3	10/29/07	Edited the Specification table, typical performance curve, and text edits.
1.4	01/29/08	Added more curves in the Typical Performance section.
1.5	07/24/08	Added the Metal Can package.
1.6	08/20/08	Text edits (updated some of the curves' titles).
1.7	08/22/08	Text edits.
1.8	02/08/10	Input changes on typical and limits in the EC table.
1.9	04/23/10	Input Typical and Limit edits on THD+N and I_{OUT} in the EC table.
2.0	06/02/10	Input text edits on the first page.
F	3/28/2013	Changed layout of National Data Sheet to TI format.

PACKAGING INFORMATION

Orderable Device	Status (1)	Package Type	Package Drawing	Pins	Package Qty	Eco Plan (2)	Lead/Ball Finish	MSL Peak Temp (3)	Op Temp (°C)	Top-Side Markings (4)	Samples
LME49713HA/NOPB	ACTIVE	TO-99	LMC	8	20	Green (RoHS & no Sb/Br)	POST-PLATE	Level-1-NA-UNLIM	-40 to 85		Samples
LME49713MA/NOPB	ACTIVE	SOIC	D	8	95	Green (RoHS & no Sb/Br)	CU SN	Level-1-260C-UNLIM	-40 to 85	L49713 MA	Samples
LME49713MAX/NOPB	ACTIVE	SOIC	D	8	2500	Green (RoHS & no Sb/Br)	CU SN	Level-1-260C-UNLIM	-40 to 85	L49713 MA	Samples

(1) The marketing status values are defined as follows:

ACTIVE: Product device recommended for new designs.

LIFEBUY: TI has announced that the device will be discontinued, and a lifetime-buy period is in effect.

NRND: Not recommended for new designs. Device is in production to support existing customers, but TI does not recommend using this part in a new design.

PREVIEW: Device has been announced but is not in production. Samples may or may not be available.

OBSOLETE: TI has discontinued the production of the device.

(2) Eco Plan - The planned eco-friendly classification: Pb-Free (RoHS), Pb-Free (RoHS Exempt), or Green (RoHS & no Sb/Br) - please check <http://www.ti.com/productcontent> for the latest availability information and additional product content details.

TBD: The Pb-Free/Green conversion plan has not been defined.

Pb-Free (RoHS): TI's terms "Lead-Free" or "Pb-Free" mean semiconductor products that are compatible with the current RoHS requirements for all 6 substances, including the requirement that lead not exceed 0.1% by weight in homogeneous materials. Where designed to be soldered at high temperatures, TI Pb-Free products are suitable for use in specified lead-free processes.

Pb-Free (RoHS Exempt): This component has a RoHS exemption for either 1) lead-based flip-chip solder bumps used between the die and package, or 2) lead-based die adhesive used between the die and leadframe. The component is otherwise considered Pb-Free (RoHS compatible) as defined above.

Green (RoHS & no Sb/Br): TI defines "Green" to mean Pb-Free (RoHS compatible), and free of Bromine (Br) and Antimony (Sb) based flame retardants (Br or Sb do not exceed 0.1% by weight in homogeneous material)

(3) MSL, Peak Temp. -- The Moisture Sensitivity Level rating according to the JEDEC industry standard classifications, and peak solder temperature.

(4) Multiple Top-Side Markings will be inside parentheses. Only one Top-Side Marking contained in parentheses and separated by a "~" will appear on a device. If a line is indented then it is a continuation of the previous line and the two combined represent the entire Top-Side Marking for that device.

Important Information and Disclaimer: The information provided on this page represents TI's knowledge and belief as of the date that it is provided. TI bases its knowledge and belief on information provided by third parties, and makes no representation or warranty as to the accuracy of such information. Efforts are underway to better integrate information from third parties. TI has taken and continues to take reasonable steps to provide representative and accurate information but may not have conducted destructive testing or chemical analysis on incoming materials and chemicals. TI and TI suppliers consider certain information to be proprietary, and thus CAS numbers and other limited information may not be available for release.

In no event shall TI's liability arising out of such information exceed the total purchase price of the TI part(s) at issue in this document sold by TI to Customer on an annual basis.

TAPE AND REEL INFORMATION



QUADRANT ASSIGNMENTS FOR PIN 1 ORIENTATION IN TAPE



*All dimensions are nominal

Device	Package Type	Package Drawing	Pins	SPQ	Reel Diameter (mm)	Reel Width W1 (mm)	A0 (mm)	B0 (mm)	K0 (mm)	P1 (mm)	W (mm)	Pin1 Quadrant
LME49713MAX/NOPB	SOIC	D	8	2500	330.0	12.4	6.5	5.4	2.0	8.0	12.0	Q1

TAPE AND REEL BOX DIMENSIONS



*All dimensions are nominal

Device	Package Type	Package Drawing	Pins	SPQ	Length (mm)	Width (mm)	Height (mm)
LME49713MAX/NOPB	SOIC	D	8	2500	349.0	337.0	45.0

LMC (O-MBCY-W8)

METAL CYLINDRICAL PACKAGE

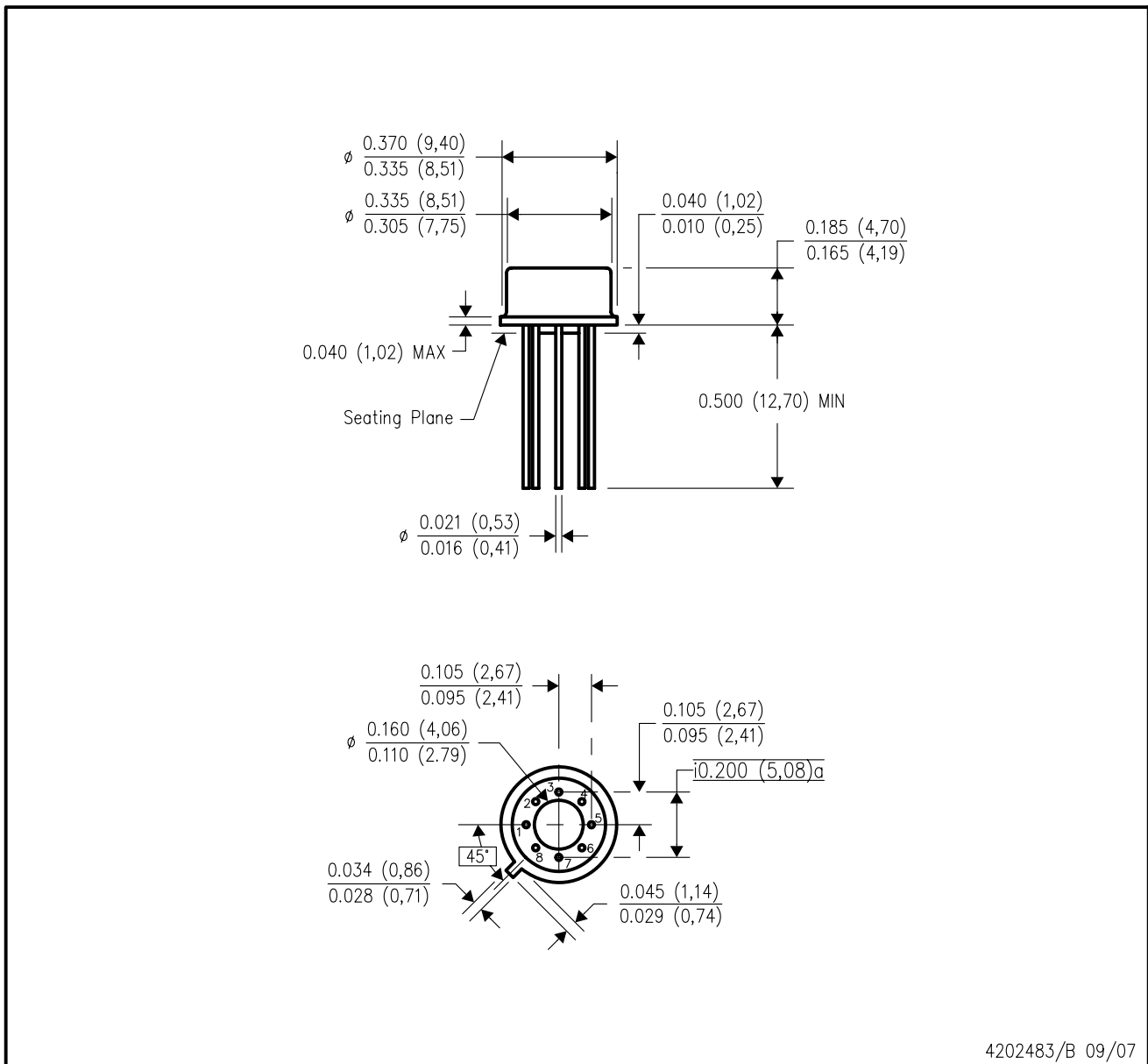

- NOTES:
- A. All linear dimensions are in inches (millimeters).
 - B. This drawing is subject to change without notice.
 - C. Leads in true position within 0.010 (0,25) R @ MMC at seating plane.
 - D. Pin numbers shown for reference only. Numbers may not be marked on package.
 - E. Falls within JEDEC MO-002/TO-99.

D (R-PDSO-G8)

PLASTIC SMALL OUTLINE



- NOTES:
- A. All linear dimensions are in inches (millimeters).
 - B. This drawing is subject to change without notice.
 - Body length does not include mold flash, protrusions, or gate burrs. Mold flash, protrusions, or gate burrs shall not exceed 0.006 (0,15) each side.
 - Body width does not include interlead flash. Interlead flash shall not exceed 0.017 (0,43) each side.
 - E. Reference JEDEC MS-012 variation AA.

IMPORTANT NOTICE

Texas Instruments Incorporated and its subsidiaries (TI) reserve the right to make corrections, enhancements, improvements and other changes to its semiconductor products and services per JESD46, latest issue, and to discontinue any product or service per JESD48, latest issue. Buyers should obtain the latest relevant information before placing orders and should verify that such information is current and complete. All semiconductor products (also referred to herein as "components") are sold subject to TI's terms and conditions of sale supplied at the time of order acknowledgment.

TI warrants performance of its components to the specifications applicable at the time of sale, in accordance with the warranty in TI's terms and conditions of sale of semiconductor products. Testing and other quality control techniques are used to the extent TI deems necessary to support this warranty. Except where mandated by applicable law, testing of all parameters of each component is not necessarily performed.

TI assumes no liability for applications assistance or the design of Buyers' products. Buyers are responsible for their products and applications using TI components. To minimize the risks associated with Buyers' products and applications, Buyers should provide adequate design and operating safeguards.

TI does not warrant or represent that any license, either express or implied, is granted under any patent right, copyright, mask work right, or other intellectual property right relating to any combination, machine, or process in which TI components or services are used. Information published by TI regarding third-party products or services does not constitute a license to use such products or services or a warranty or endorsement thereof. Use of such information may require a license from a third party under the patents or other intellectual property of the third party, or a license from TI under the patents or other intellectual property of TI.

Reproduction of significant portions of TI information in TI data books or data sheets is permissible only if reproduction is without alteration and is accompanied by all associated warranties, conditions, limitations, and notices. TI is not responsible or liable for such altered documentation. Information of third parties may be subject to additional restrictions.

Resale of TI components or services with statements different from or beyond the parameters stated by TI for that component or service voids all express and any implied warranties for the associated TI component or service and is an unfair and deceptive business practice. TI is not responsible or liable for any such statements.

Buyer acknowledges and agrees that it is solely responsible for compliance with all legal, regulatory and safety-related requirements concerning its products, and any use of TI components in its applications, notwithstanding any applications-related information or support that may be provided by TI. Buyer represents and agrees that it has all the necessary expertise to create and implement safeguards which anticipate dangerous consequences of failures, monitor failures and their consequences, lessen the likelihood of failures that might cause harm and take appropriate remedial actions. Buyer will fully indemnify TI and its representatives against any damages arising out of the use of any TI components in safety-critical applications.

In some cases, TI components may be promoted specifically to facilitate safety-related applications. With such components, TI's goal is to help enable customers to design and create their own end-product solutions that meet applicable functional safety standards and requirements. Nonetheless, such components are subject to these terms.

No TI components are authorized for use in FDA Class III (or similar life-critical medical equipment) unless authorized officers of the parties have executed a special agreement specifically governing such use.

Only those TI components which TI has specifically designated as military grade or "enhanced plastic" are designed and intended for use in military/aerospace applications or environments. Buyer acknowledges and agrees that any military or aerospace use of TI components which have **not** been so designated is solely at the Buyer's risk, and that Buyer is solely responsible for compliance with all legal and regulatory requirements in connection with such use.

TI has specifically designated certain components as meeting ISO/TS16949 requirements, mainly for automotive use. In any case of use of non-designated products, TI will not be responsible for any failure to meet ISO/TS16949.

Products

Audio	www.ti.com/audio
Amplifiers	amplifier.ti.com
Data Converters	dataconverter.ti.com
DLP® Products	www.dlp.com
DSP	dsp.ti.com
Clocks and Timers	www.ti.com/clocks
Interface	interface.ti.com
Logic	logic.ti.com
Power Mgmt	power.ti.com
Microcontrollers	microcontroller.ti.com
RFID	www.ti-rfid.com
OMAP Applications Processors	www.ti.com/omap
Wireless Connectivity	www.ti.com/wirelessconnectivity

Applications

Automotive and Transportation	www.ti.com/automotive
Communications and Telecom	www.ti.com/communications
Computers and Peripherals	www.ti.com/computers
Consumer Electronics	www.ti.com/consumer-apps
Energy and Lighting	www.ti.com/energy
Industrial	www.ti.com/industrial
Medical	www.ti.com/medical
Security	www.ti.com/security
Space, Avionics and Defense	www.ti.com/space-avionics-defense
Video and Imaging	www.ti.com/video

TI E2E Community

e2e.ti.com