

# LM48860 Boomer® Audio Power Amplifier Series Ground-Referenced, Ultra Low Noise, Fixed Gain Stereo Headphone Amplifier

Check for Samples: [LM48860](#)

## FEATURES

- Fixed Logic Levels with Supply Voltage
- Ground Referenced Outputs
- High PSRR
- Available in Space-Saving DSBGA Package
- Ultra Low Current Shutdown Mode
- Improved Pop & Click Circuitry Eliminates Noises During Turn-On and Turn-Off Transitions
- No Output Coupling Capacitors, Snubber Networks, Bootstrap Capacitors, or Gain-Setting Resistors Required
- Shutdown Either Channel Independently

## APPLICATIONS

- Mobile Phones
- MP3 Players
- PDAs
- Portable Electronic Devices
- Notebook PCs

## KEY SPECIFICATIONS

- PSRR at 217Hz ( $V_{DD} = 3.0V$ ): 80dB (typ)
- Stereo Power Output at  $V_{DD} = 3V$ ,  $R_L = 16\Omega$ , THD+N = 1%: 40mW (typ)
- Shutdown Current 0.1 $\mu$ A (typ)
- Internal Fixed Gain: 1.5V/V (typ)
- Operating Voltage: 2.0V to 5.5V

## DESCRIPTION

The LM48860 is a ground referenced, fixed-gain audio power amplifier capable of delivering 40mW per channel of continuous average power into a 16 $\Omega$  single-ended load with less than 1% THD+N from a 3V power supply.

The LM48860 features a new circuit technology that utilizes a charge pump to generate a negative reference voltage. This allows the outputs to be biased about ground, thereby eliminating output-coupling capacitors typically used with normal single-ended loads.

Boomer audio power amplifiers were designed specifically to provide high quality output power with a minimal amount of external components. The LM48860 does not require output coupling capacitors or bootstrap capacitors, and therefore is ideally suited for mobile phone and other low voltage applications where minimal power consumption is a primary requirement.

The LM48860 features a low-power consumption shutdown mode selectable for either channel separately. This is accomplished by driving either the  $\overline{SD\_RC}$  (Shutdown Right Channel) or  $\overline{SD\_LC}$  (Shutdown Left Channel) (or both) pins with logic low, depending on which channel is desired shutdown. Additionally, the LM48860 features an internal thermal shutdown protection mechanism.

The LM48860 contains advanced pop & click circuitry that eliminates noises which would otherwise occur during turn-on and turn-off transitions.

The LM48860 has an internal fixed gain of 1.5V/V.



Please be aware that an important notice concerning availability, standard warranty, and use in critical applications of Texas Instruments semiconductor products and disclaimers thereto appears at the end of this data sheet.

All trademarks are the property of their respective owners.

Typical Application

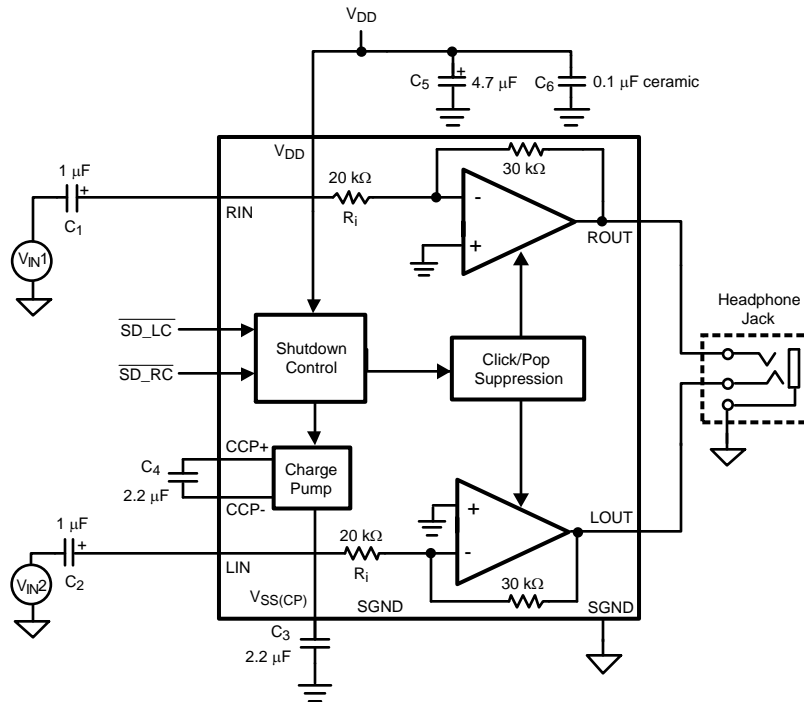

Figure 1. Typical Audio Amplifier Application Circuit

Connection Diagram

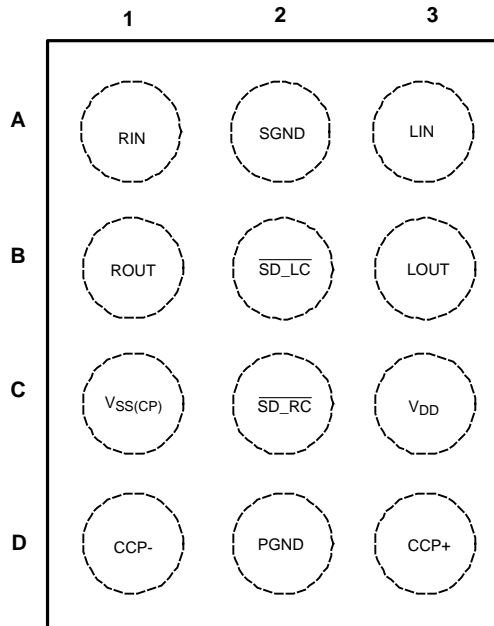

Figure 2. DSBGA - Top View  
See YZR0012 Package

### PIN DESCRIPTIONS

Pin	Name	Function
A1	RIN	Right Channel Input
A2	SGND	Signal Ground
A3	LIN	Left Channel Input
B1	ROUT	Right Channel Output
B2	$\overline{\text{SD\_LC}}$	Active Low Shutdown, Left Channel
B3	LOUT	Left Channel Output
C1	$V_{\text{SS(CP)}}$	Charge Pump Voltage Output
C2	$\overline{\text{SD\_RC}}$	Active-Low Shutdown, Right Channel
C3	$V_{\text{DD}}$	Supply Voltage
D1	CCP-	Negative Terminal - Charge Pump Flying Capacitor
D2	PGND	Power Ground
D3	CCP+	Positive Terminal - Charge Pump Flying Capacitor



These devices have limited built-in ESD protection. The leads should be shorted together or the device placed in conductive foam during storage or handling to prevent electrostatic damage to the MOS gates.

### Absolute Maximum Ratings<sup>(1)(2)</sup>

Supply Voltage	6.0V
Storage Temperature	-65°C to +150°C
Input Voltage	-0.3V to $V_{\text{DD}}$
Power Dissipation <sup>(3)</sup>	Internally Limited
ESD Rating <sup>(4)</sup>	2000V
ESD Rating <sup>(5)</sup>	200V
Junction Temperature	150°C
Thermal Resistance	
$\theta_{\text{JA}}$ (typ) DSBGA	59.3°C/W

- (1) The *Electrical Characteristics* tables list ensure specifications under the listed *Recommended Operating Conditions* except as otherwise modified or specified by the *Electrical Characteristics Conditions* and/or Notes. Typical specifications are estimations only and are not specified.
- (2) If Military/Aerospace specified devices are required, please contact the TI Sales Office/ Distributors for availability and specifications.
- (3) The maximum power dissipation must be derated at elevated temperatures and is dictated by  $T_{\text{JMAX}}$ ,  $\theta_{\text{JA}}$ , and the ambient temperature,  $T_{\text{A}}$ . The maximum allowable power dissipation is  $P_{\text{DMAX}} = (T_{\text{JMAX}} - T_{\text{A}}) / \theta_{\text{JA}}$  or the number given in *Absolute Maximum Ratings*, whichever is lower. For the LM48860, see [power derating](#) curves for additional information.
- (4) Human body model, applicable std. JESD22-A114C.
- (5) Machine model, applicable std. JESD22-A115-A.

### Operating Ratings

Temperature Range	
$T_{\text{MIN}} \leq T_{\text{A}} \leq T_{\text{MAX}}$	$-40^{\circ}\text{C} \leq T_{\text{A}} \leq 85^{\circ}\text{C}$
Supply Voltage ( $V_{\text{DD}}$ )	$2.0\text{V} \leq V_{\text{DD}} \leq 5.5\text{V}$

**Electrical Characteristics  $V_{DD} = 3V$  <sup>(1)(2)</sup>**

The following specifications apply for  $V_{DD} = 3V$  and  $16\Omega$  load unless otherwise specified. Limits apply to  $T_A = 25^\circ C$ .

Symbol	Parameter	Conditions	LM48860		Units (Limits)
			Typical <sup>(3)</sup>	Limit <sup>(4)</sup>	
$I_{DD}$	Quiescent Power Supply Current Full Power Mode	$V_{DD} = 3.0V$ , $V_{IN} = 0V$ , inputs terminated both channels enabled	4	5.5	mA (max)
		$V_{DD} = 5.0V$ , $V_{IN} = 0V$ , inputs terminated both channels enabled	4.2		mA
$I_{SD}$	Shutdown Current	$SD\_LC = SD\_RC = GND$	0.1	1	$\mu A$ (max)
		$SD\_LC = SD\_RC = GND$ , $V_{DD} = 5.0V$	0.1	1	$\mu A$ (max)
$V_{OS}$	Output Offset Voltage	$R_L = 32\Omega$ , $V_{IN} = 0V$	0.7	5.5	mV (max)
$A_V$	Voltage Gain		-1.5		V/V
$\Delta A_V$	Channel-to-channel Gain Matching		1		%
$R_{IN}$	Input Resistance		20	15 25	k $\Omega$ (min) k $\Omega$ (max)
$P_O$	Output Power	THD+N = 1% (max); f = 1kHz, $R_L = 16\Omega$ , (two channels in phase)	40	35	mW (min)
		THD+N = 1% (max); f = 1kHz, $R_L = 32\Omega$ , (two channels in phase)	50	40	mW (min)
THD+N	Total Harmonic Distortion + Noise	$P_O = 20mW$ , f = 1kHz, $R_L = 16\Omega$ (two channels in phase)	0.025		%
		$P_O = 25mW$ , f = 1kHz, $R_L = 32\Omega$ (two channels in phase)	0.014		%
PSRR	Power Supply Rejection Ratio Full Power Mode	$V_{RIPPLE} = 200mV_{PP}$ , Input Referred			
		f = 217Hz	80	73	dB (min)
		f = 1kHz	75		dB
		f = 20kHz	60		dB
SNR	Signal-to-Noise Ratio	$R_L = 32\Omega$ , $P_{OUT} = 50mW$ , f = 1kHz, BW = 20Hz to 22kHz, A-weighted	105		dB
$V_{IH}$	Shutdown Input Voltage High	$V_{DD} = 2.0V$ to $5.5V$		1.2	V (min)
$V_{IL}$	Shutdown Input Voltage Low	$V_{DD} = 2.0V$ to $5.5V$		0.45	V (max)
$X_{TALK}$	Crosstalk	$R_L = 16\Omega$ , $P_O = 1.6mW$ , f = 1kHz	75		dB
$\epsilon_{OS}$	Output Noise	A-weighted filter, $V_{IN} = 0V$	8		$\mu V$
$Z_{OUT}$	Output Impedance	$V_{SD} = GND$ Input Terminated		20	k $\Omega$ (min)
		Input not terminated $SD\_LC = SD\_RC = GND$	30 30		k $\Omega$
$I_L$	Input Leakage		$\pm 0.1$		nA

- (1) "Absolute Maximum Ratings" indicate limits beyond which damage to the device may occur, including inoperability and degradation of device reliability and/or performance. Functional operation of the device and/or non-degradation at the Absolute Maximum Ratings or other conditions beyond those indicated in the Recommended Operating Conditions is not implied. The Recommended Operating Conditions indicate conditions at which the device is functional and the device should not be operated beyond such conditions. All voltages are measured with respect to the ground pin, unless otherwise specified.
- (2) The Electrical Characteristics tables list ensure specifications under the listed Recommended Operating Conditions except as otherwise modified or specified by the Electrical Characteristics Conditions and/or Notes. Typical specifications are estimations only and are not specified.
- (3) Typical values represent most likely parametric norms at  $T_A = +25^\circ C$ , and at the Recommended Operation Conditions at the time of product characterization and are not specified.
- (4) Datasheet min/max specification limits are ensured by test or statistical analysis.

## External Components Description

(Figure 1)

Components		Functional Description
1.	C <sub>1</sub>	Input coupling capacitor which blocks the DC voltage at the amplifier's input terminals. Also creates a high pass-pass filter with R <sub>i</sub> at $f_c = 1/(2R_i C_1)$ . Refer to the section <a href="#">Proper Selection of External Components</a> , for an explanation of how to determine the value of C <sub>1</sub> .
2.	C <sub>2</sub>	Input coupling capacitor which blocks the DC voltage at the amplifier's input terminals. Also creates a high pass-pass filter with R <sub>i</sub> at $f_c = 1/(2R_i C_2)$ . Refer to the <a href="#">Power Supply Bypassing</a> section for an explanation of how to determine the value of C <sub>2</sub> .
3.	C <sub>3</sub>	Output capacitor. Low ESR ceramic capacitor ( $\leq 100\text{m}\Omega$ )
4.	C <sub>4</sub>	Flying capacitor. Low ESR ceramic capacitor ( $\leq 100\text{m}\Omega$ )
5.	C <sub>5</sub>	Tantalum capacitor. Supply bypass capacitor which provides power supply filtering. Refer to the <a href="#">Power Supply Bypassing</a> section for information concerning proper placement and selection of the supply bypass capacitor.
6.	C <sub>6</sub>	Ceramic capacitor. Supply bypass capacitor which provides power supply filtering. Refer to the <a href="#">Power Supply Bypassing</a> section for information concerning proper placement and selection of the supply bypass capacitor.

### Typical Performance Characteristics

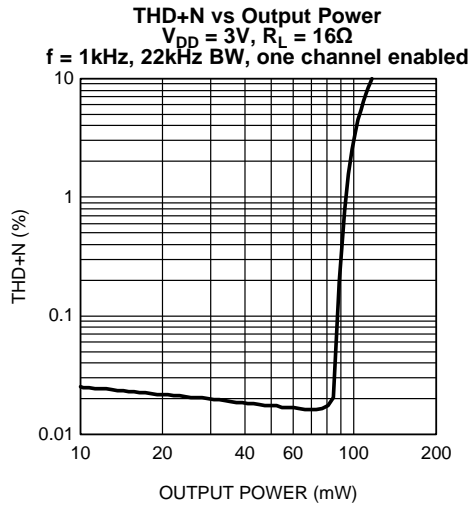

Figure 3.

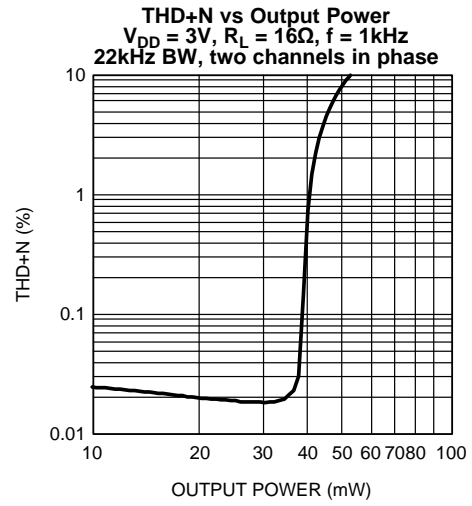

Figure 4.

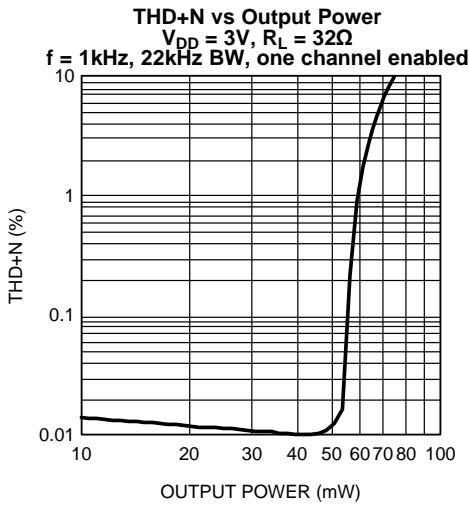

Figure 5.

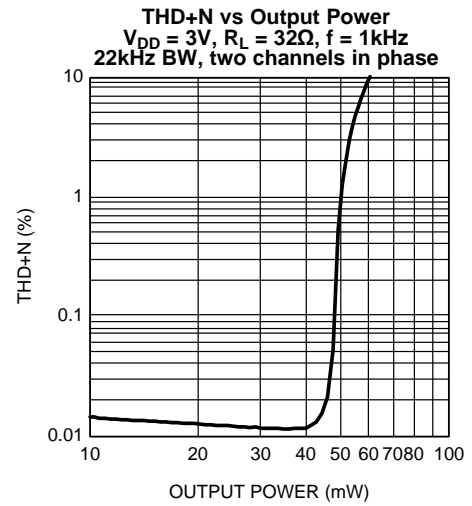

Figure 6.

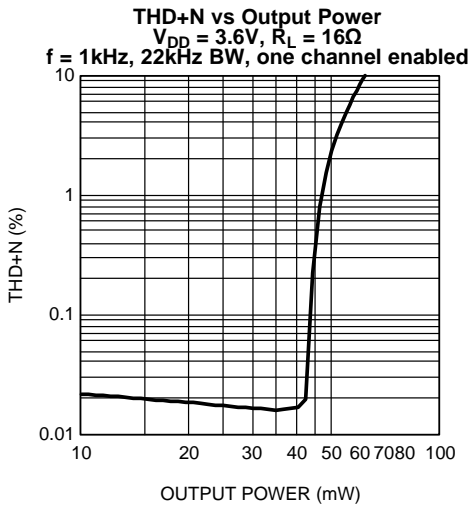

Figure 7.

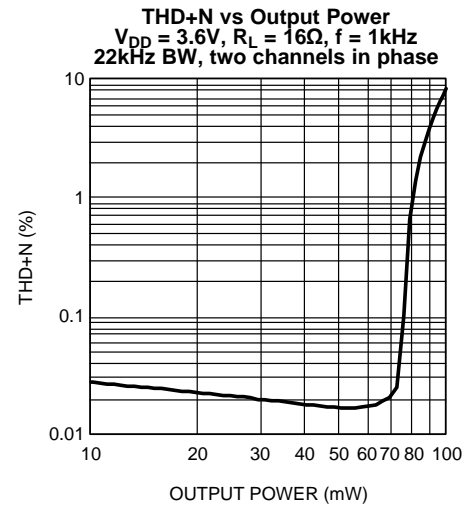
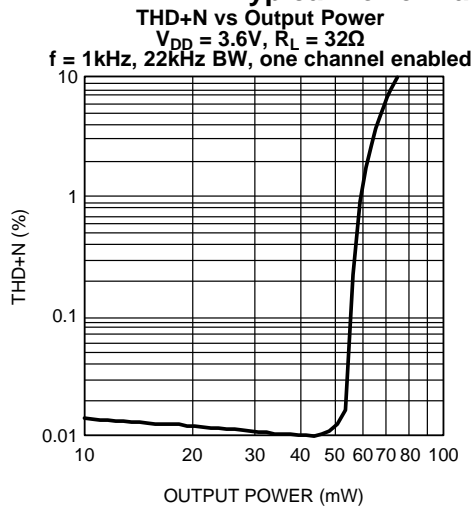
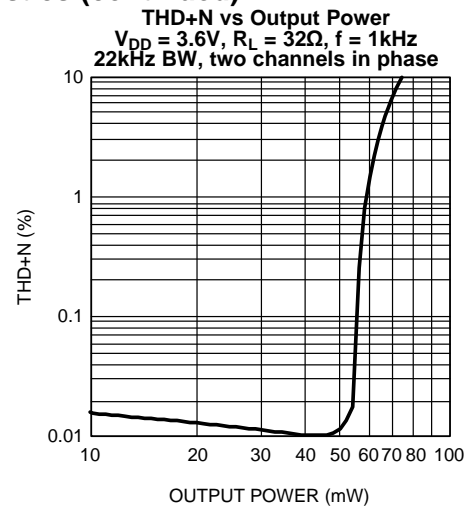

Figure 8.

**Typical Performance Characteristics (continued)**



**Figure 9.**



**Figure 10.**

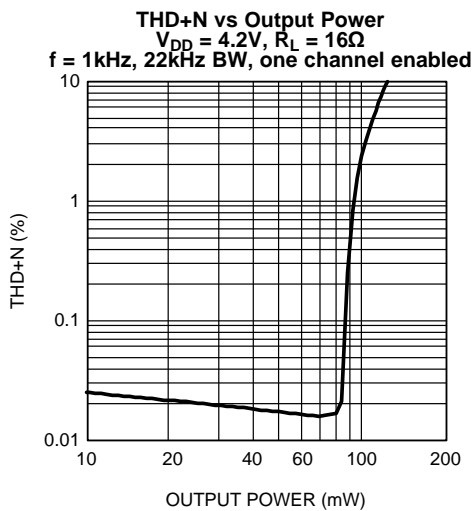

**Figure 11.**

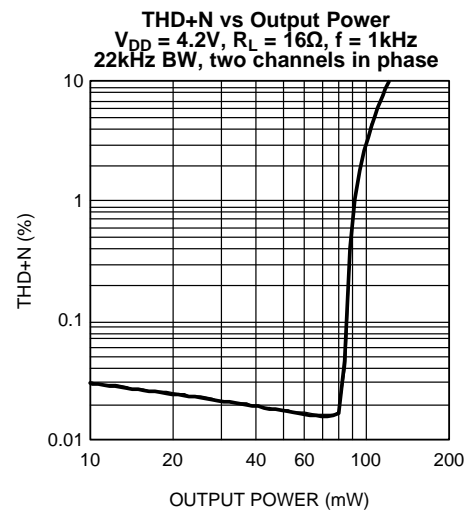

**Figure 12.**

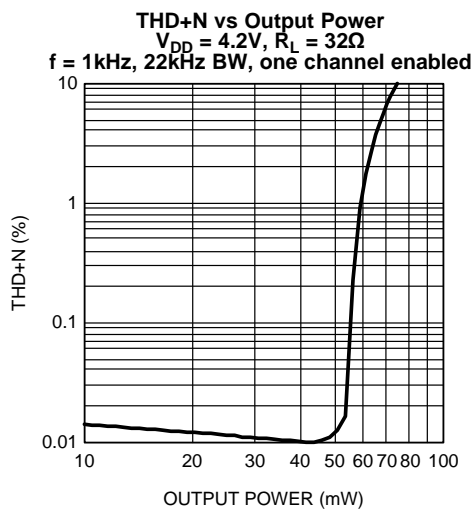

**Figure 13.**

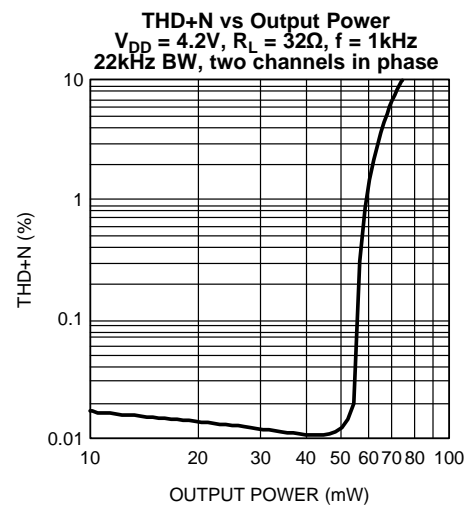

**Figure 14.**

**Typical Performance Characteristics (continued)**

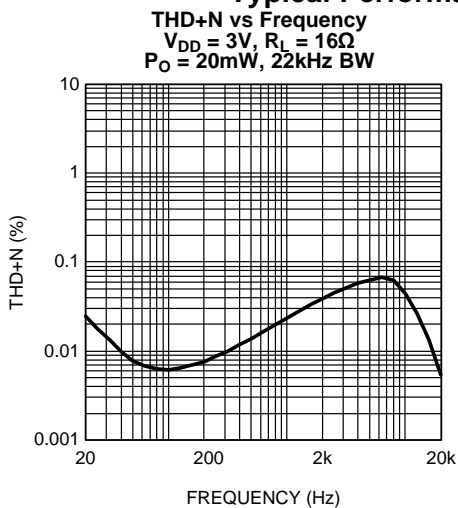

Figure 15.

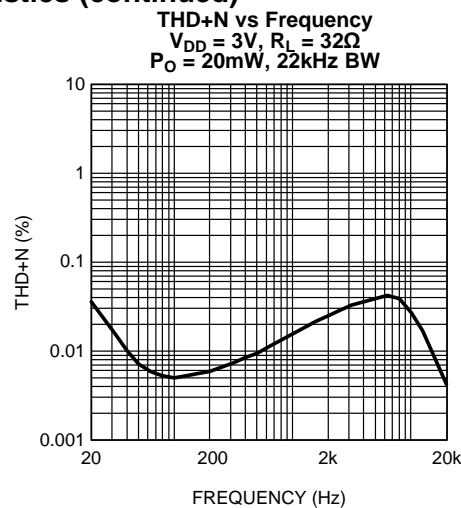

Figure 16.

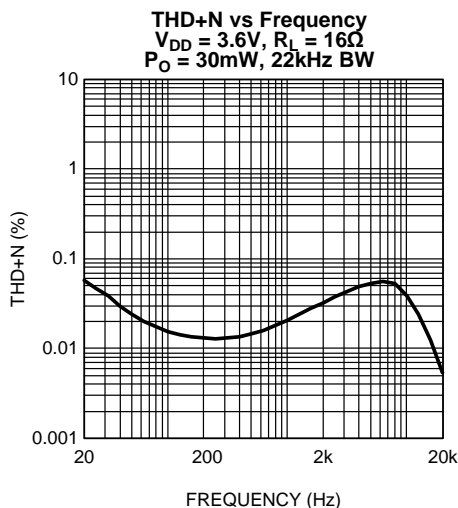

Figure 17.

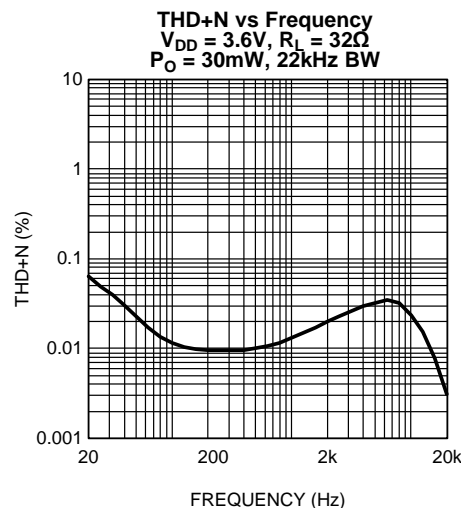

Figure 18.

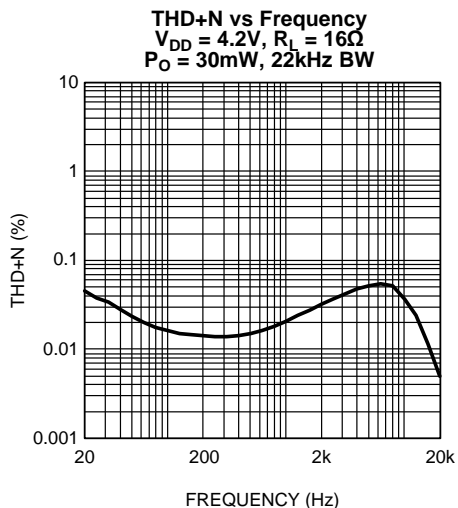

Figure 19.

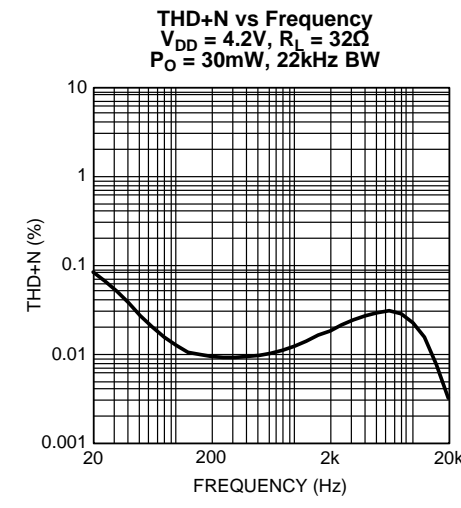

Figure 20.



Typical Performance Characteristics (continued)

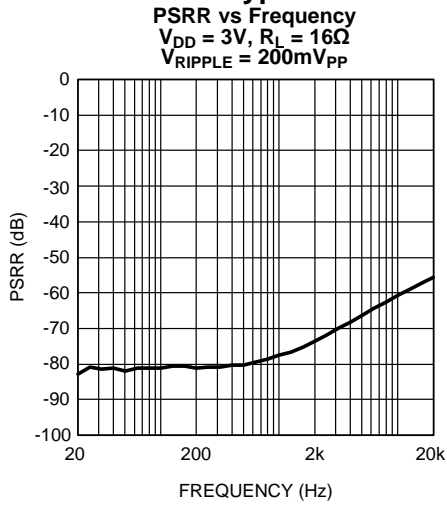

Figure 21.

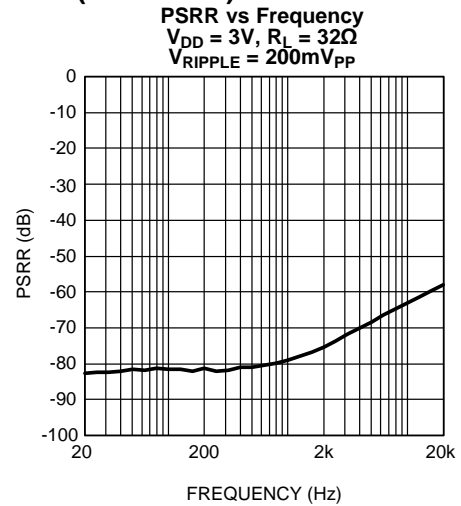

Figure 22.

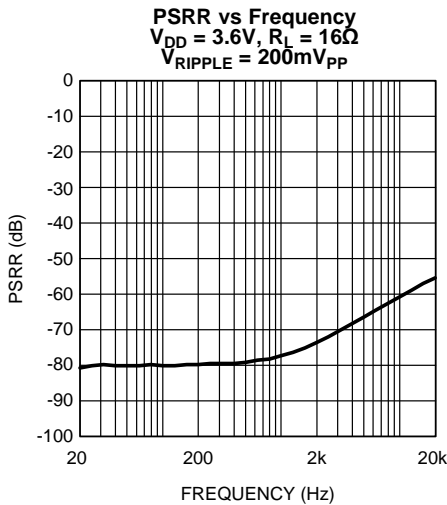

Figure 23.

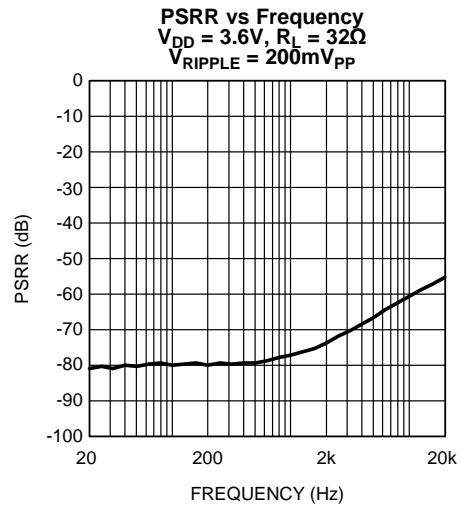

Figure 24.

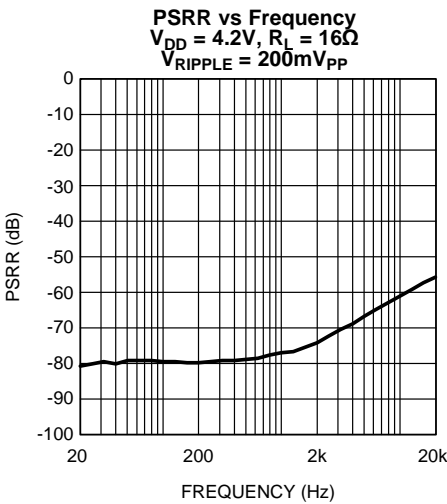

Figure 25.

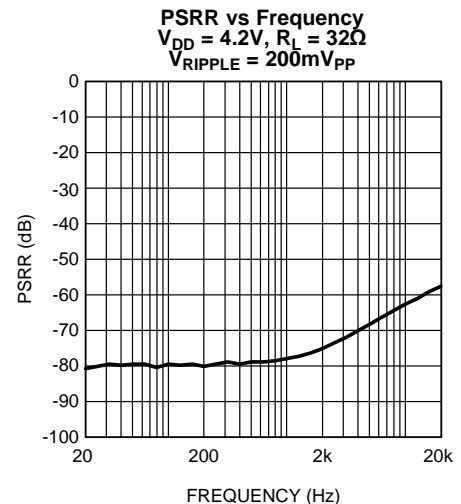

Figure 26.

**Typical Performance Characteristics (continued)**

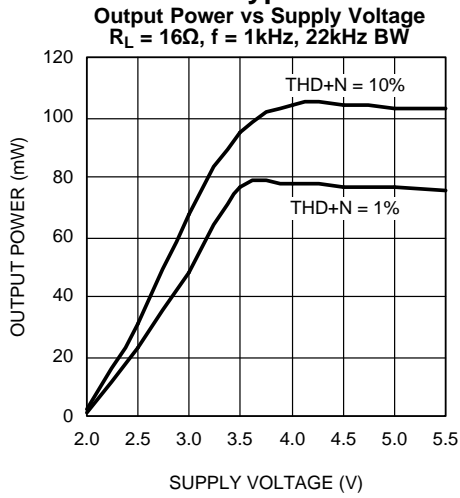

Figure 27.

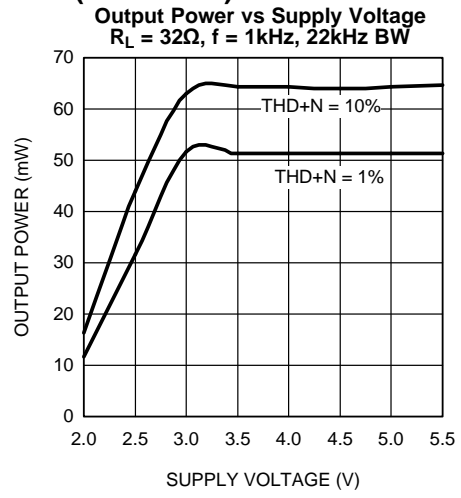

Figure 28.

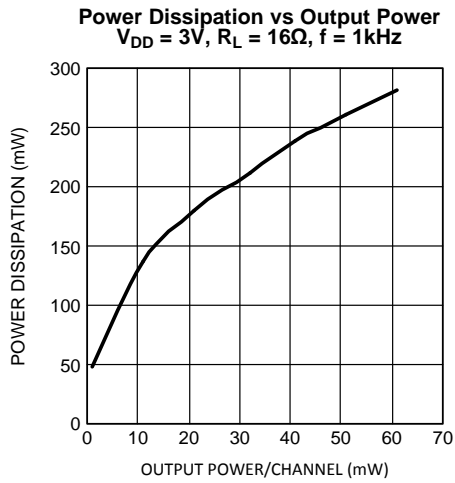

Figure 29.

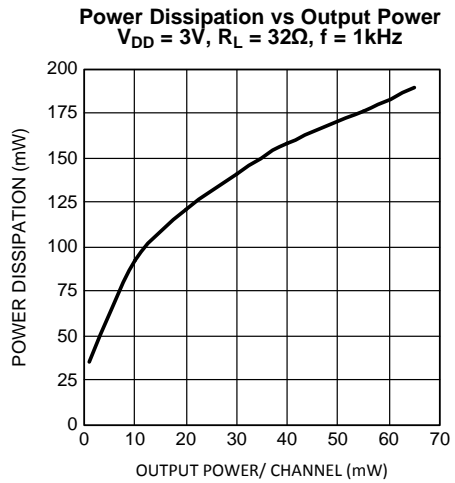

Figure 30.

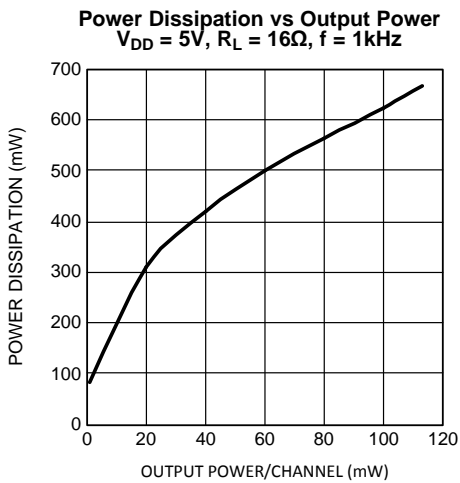

Figure 31.

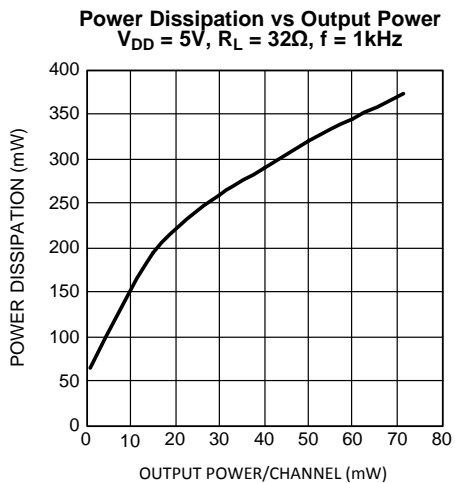

Figure 32.

**Typical Performance Characteristics (continued)**

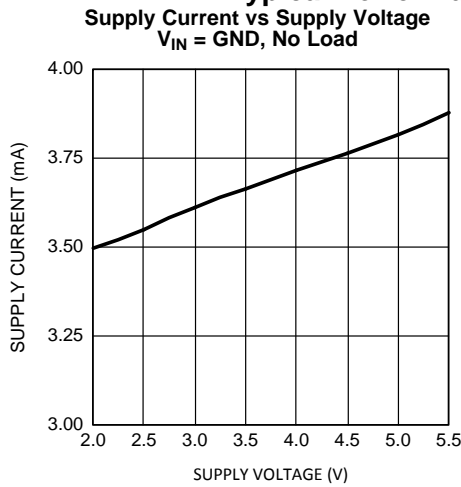

Figure 33.

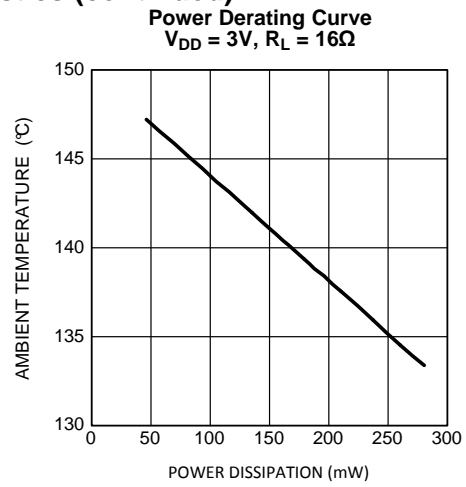

Figure 34.

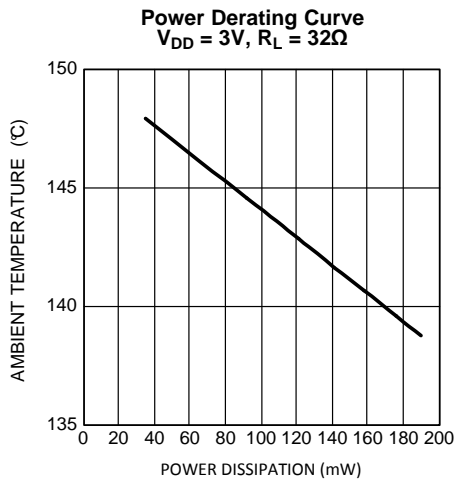

Figure 35.

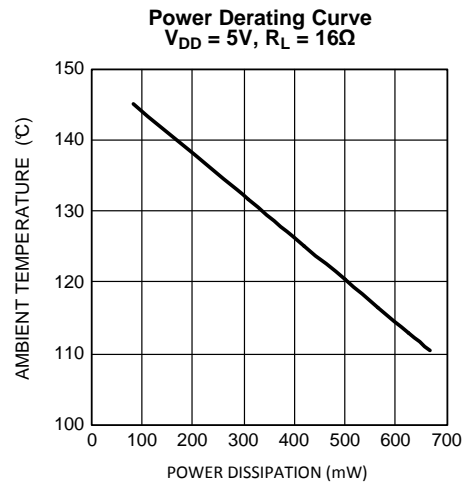

Figure 36.

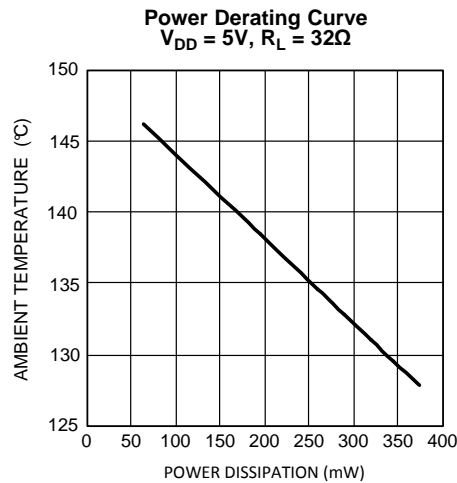

Figure 37.

## APPLICATION INFORMATION

### SUPPLY VOLTAGE SEQUENCING

It is a good general practice to first apply the supply voltage to a CMOS device before any other signal or supply on other pins. This is also true for the LM48860 audio amplifier which is a CMOS device.

Before applying any signal to the inputs or shutdown pins of the LM48860, it is important to apply a supply voltage to the  $V_{DD}$  pins. After the device has been powered, signals may be applied to the shutdown pins (see [MICRO POWER SHUTDOWN](#)) and input pins.

### ELIMINATING THE OUTPUT COUPLING CAPACITOR

The LM48860 features a low noise inverting charge pump that generates an internal negative supply voltage. This allows the outputs of the LM48860 to be biased about GND instead of a nominal DC voltage, like traditional headphone amplifiers. Because there is no DC component, the large DC blocking capacitors (typically 220 $\mu$ F) are not necessary. The coupling capacitors are replaced by two, small ceramic charge pump capacitors, saving board space and cost.

Eliminating the output coupling capacitors also improves low frequency response. In traditional headphone amplifiers, the headphone impedance and the output capacitor form a high pass filter that not only blocks the DC component of the output, but also attenuates low frequencies, impacting the bass response. Because the LM48860 does not require the output coupling capacitors, the low frequency response of the device is not degraded by external components.

In addition to eliminating the output coupling capacitors, the ground referenced output nearly doubles the available dynamic range of the LM48860 when compared to a traditional headphone amplifier operating from the same supply voltage.

### OUTPUT TRANSIENT ('CLICK AND POPS') ELIMINATED

The LM48860 contains advanced circuitry that virtually eliminates output transients ('clicks and pops'). This circuitry prevents all traces of transients when the supply voltage is first applied or when the part resumes operation after coming out of shutdown mode.

### AMPLIFIER CONFIGURATION EXPLANATION

As shown in [Figure 1](#), the LM48860 has two internal operational amplifiers. The two amplifiers have internally configured gain.

Since this is an output ground-referenced amplifier, the LM48860 does not require output coupling capacitors.

### POWER DISSIPATION

From the graph (THD+N vs Output Power ,  $V_{DD} = 3V$ ,  $R_L = 16\Omega$ ,  $f = 1kHz$ , 22kHz BW, two channels in phase, page 6) assuming a 3V power supply and a 16 $\Omega$  load, the maximum power dissipation point and thus the maximum package dissipation point is 281mW. The maximum power dissipation point obtained must not be greater than the power dissipation that results from [Equation 1](#).

$$P_{DMAX} = (T_{JMAX} - T_A) / (\theta_{JA}) \quad (1)$$

For the DSBGA package  $\theta_{JA} = 59.3^{\circ}C/W$ .  $T_{JMAX} = 150^{\circ}C$  for the LM48860. Depending on the ambient temperature,  $T_A$ , of the system surroundings, Equation 1 can be used to find the maximum internal power dissipation supported by the IC packaging. If the maximum power dissipation from the graph is greater than that of [Equation 1](#), then either the supply voltage must be decreased, the load impedance increased or  $T_A$  reduced (see [power derating](#) curves). For the application of a 5V power supply, with a 16 $\Omega$  load, the maximum ambient temperature possible without violating the maximum junction temperature is approximately 110 $^{\circ}C$  provided that device operation is around the maximum power dissipation point. Power dissipation is a function of output power and thus, if typical operation is not around the maximum power dissipation point, the ambient temperature may be increased accordingly.

## POWER SUPPLY BYPASSING

As with any power amplifier, proper supply bypassing is critical for low noise performance and high power supply rejection. Applications that employ a 3V power supply typically use a 4.7μF capacitor in parallel with a 0.1μF ceramic filter capacitor to stabilize the power supply's output, reduce noise on the supply line, and improve the supply's transient response. Keep the length of leads and traces that connect capacitors between the LM48860's power supply pin and ground as short as possible.

## MICRO POWER SHUTDOWN

The voltage applied to the  $\overline{\text{SD\_LC}}$  (shutdown left channel) pin and the  $\overline{\text{SD\_RC}}$  (shutdown right channel) pin controls the LM48860's shutdown function. When active, the LM48860's micropower shutdown feature turns off the amplifiers' bias circuitry, reducing the supply current. The trigger point is 0.45V for a logic-low level, and 1.2V for logic-high level. The low 0.01μA (typ) shutdown current is achieved by applying a voltage that is as near as ground as possible to the  $\overline{\text{SD\_LC}}/\overline{\text{SD\_RC}}$  pins. A voltage that is higher than ground may increase the shutdown current. Do not let  $\overline{\text{SD\_LC}}/\overline{\text{SD\_RC}}$  float, connect either to high or low.

## SELECTING PROPER EXTERNAL COMPONENTS

Optimizing the LM48860's performance requires properly selecting external components. Though the LM48860 operates well when using external components with wide tolerances, best performance is achieved by optimizing component values.

### Charge Pump Capacitor Selection

Use low ESR (equivalent series resistance) (<100mΩ) ceramic capacitors with an X7R dielectric for best performance. Low ESR capacitors keep the charge pump output impedance to a minimum, extending the headroom on the negative supply. Higher ESR capacitors result in reduced output power from the audio amplifiers.

Charge pump load regulation and output impedance are affected by the value of the flying capacitor (C4). A larger valued C4 (up to 3.3μF) improves load regulation and minimizes charge pump output resistance. Beyond 3.3μF, the switch-on resistance dominates the output impedance.

The output ripple is affected by the value and ESR of the output capacitor (C3). Larger capacitors reduce output ripple on the negative power supply. Lower ESR capacitors minimize the output ripple and reduce the output impedance of the charge pump.

The LM48860 charge pump design is optimized for 2.2μF, low ESR, ceramic, flying and output capacitors.

### Input Capacitor Value Selection

Amplifying the lowest audio frequencies requires high value input coupling capacitors (C1 and C2 in [Figure 1](#)). A high value capacitor can be expensive and may compromise space efficiency in portable designs. In many cases, however, the speakers used in portable systems, whether internal or external, have little ability to reproduce signals below 150Hz. Applications using speakers with this limited frequency response reap little improvement by using high value input and output capacitors.

As shown in [Figure 1](#), the internal input resistor,  $R_i$  and the input capacitors, C1 and C2, produce a -3dB high-pass filter cutoff frequency that is found using [Equation 2](#).

$$f_{i-3dB} = 1 / 2\pi R_{iN} C \quad (\text{Hz}) \quad (2)$$

The value of  $R_{iN}$  can be found in the [Electrical Characteristics](#) tables.

Demonstration Board PCB Layout

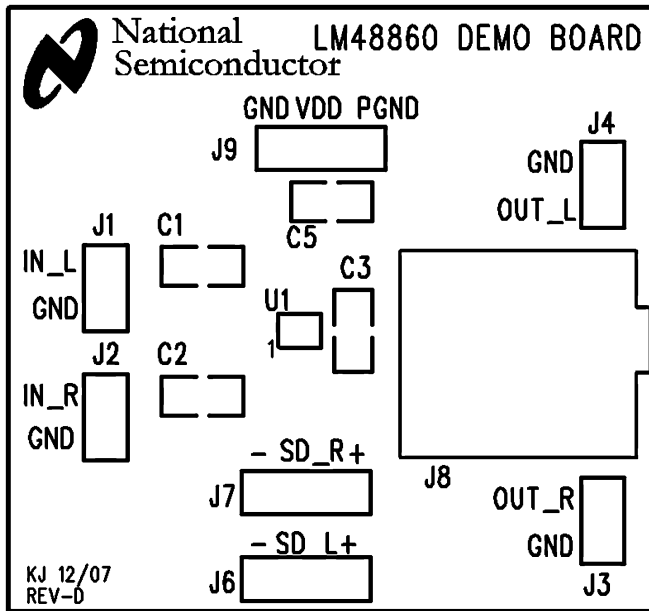

Figure 38. Top Silkscreen

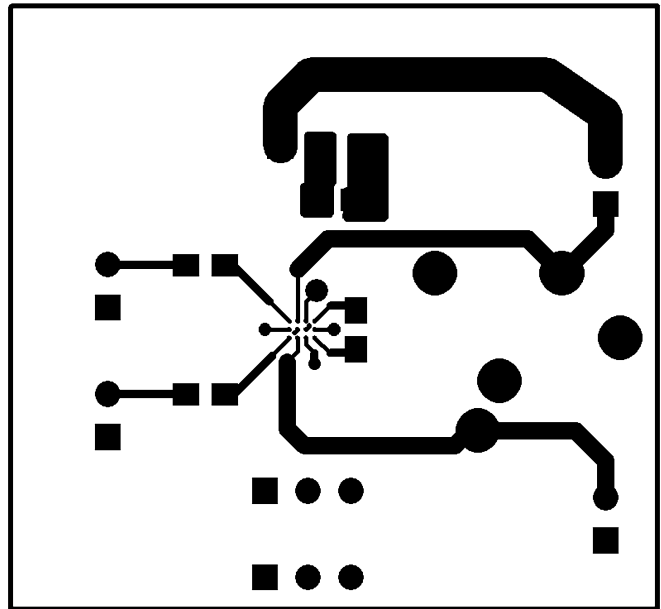

Figure 39. Top Layer

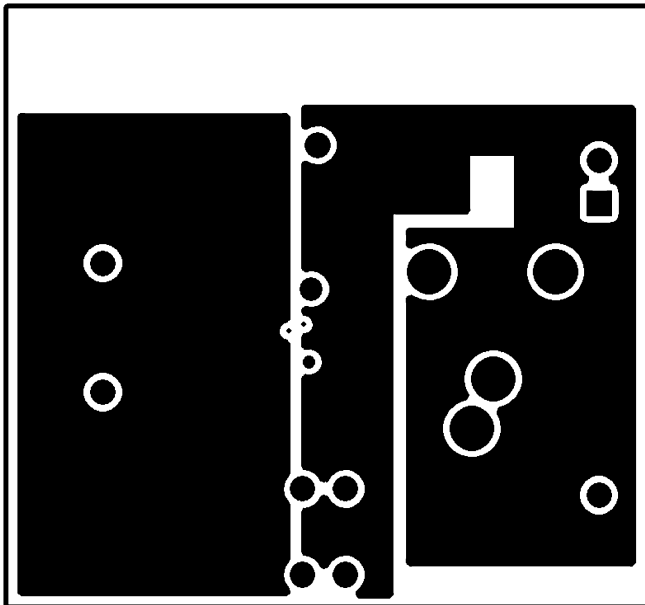

Figure 40. Midlayer 1

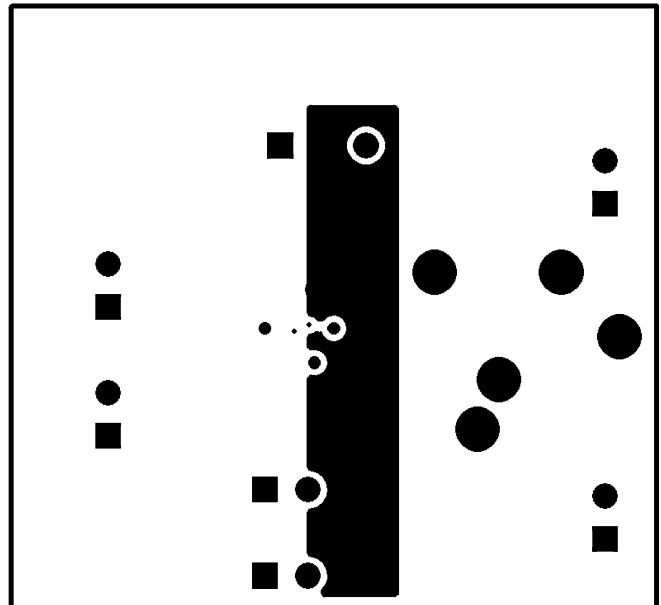

Figure 41. Midlayer 2

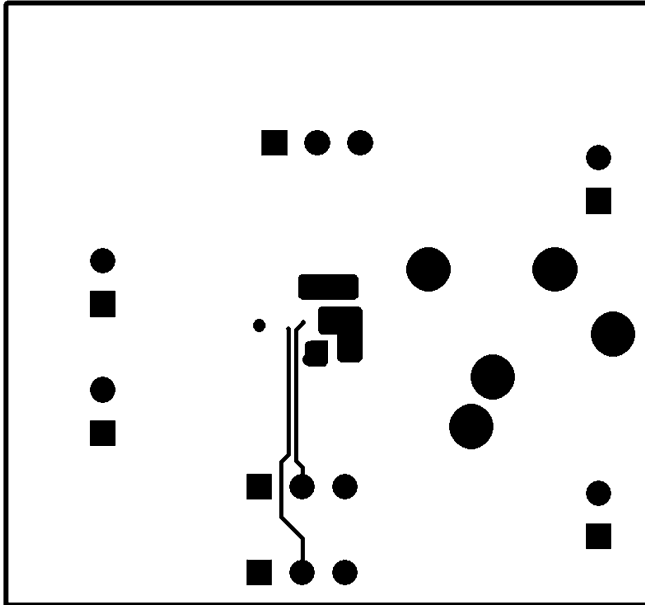

Figure 42. Bottom Layer

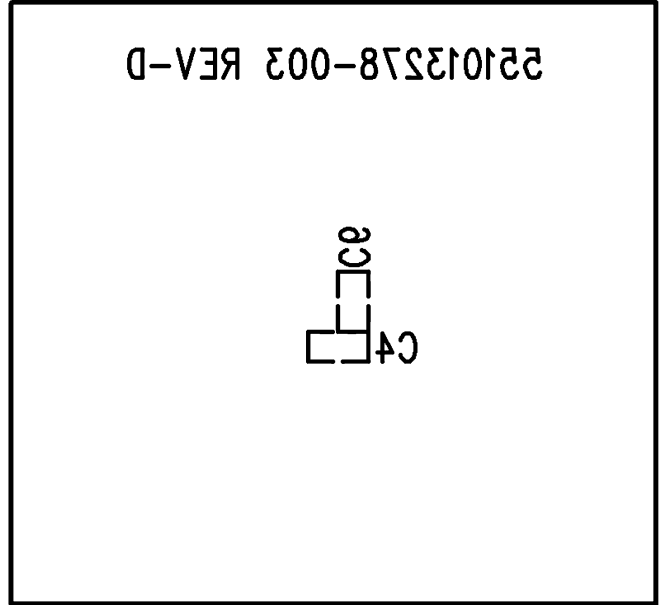

Figure 43. Bottom Silkscreen

**REVISION HISTORY**

<b>Rev</b>	<b>Date</b>	<b>Description</b>
1.0	01/16/08	Initial release.
1.01	01/29/08	Text edits.
1.02	02/14/08	Fixed typos (x-axis) on few curves.
1.03	10/17/08	Edited the X1 and X2 limits under the Physical Dimension section.
D	05/02/2013	Changed layout of National Data Sheet to TI format.



**PACKAGING INFORMATION**

Orderable Device	Status (1)	Package Type	Package Drawing	Pins	Package Qty	Eco Plan (2)	Lead/Ball Finish	MSL Peak Temp (3)	Op Temp (°C)	Top-Side Markings (4)	Samples
LM48860TL/NOPB	ACTIVE	DSBGA	YZR	12	250	Green (RoHS & no Sb/Br)	SNAGCU	Level-1-260C-UNLIM	-40 to 84	GJ7	<a href="#">Samples</a>
LM48860TLX/NOPB	ACTIVE	DSBGA	YZR	12	3000	Green (RoHS & no Sb/Br)	SNAGCU	Level-1-260C-UNLIM	-40 to 84	GJ7	<a href="#">Samples</a>

(1) The marketing status values are defined as follows:

**ACTIVE:** Product device recommended for new designs.

**LIFEBUY:** TI has announced that the device will be discontinued, and a lifetime-buy period is in effect.

**NRND:** Not recommended for new designs. Device is in production to support existing customers, but TI does not recommend using this part in a new design.

**PREVIEW:** Device has been announced but is not in production. Samples may or may not be available.

**OBSOLETE:** TI has discontinued the production of the device.

(2) Eco Plan - The planned eco-friendly classification: Pb-Free (RoHS), Pb-Free (RoHS Exempt), or Green (RoHS & no Sb/Br) - please check <http://www.ti.com/productcontent> for the latest availability information and additional product content details.

**TBD:** The Pb-Free/Green conversion plan has not been defined.

**Pb-Free (RoHS):** TI's terms "Lead-Free" or "Pb-Free" mean semiconductor products that are compatible with the current RoHS requirements for all 6 substances, including the requirement that lead not exceed 0.1% by weight in homogeneous materials. Where designed to be soldered at high temperatures, TI Pb-Free products are suitable for use in specified lead-free processes.

**Pb-Free (RoHS Exempt):** This component has a RoHS exemption for either 1) lead-based flip-chip solder bumps used between the die and package, or 2) lead-based die adhesive used between the die and leadframe. The component is otherwise considered Pb-Free (RoHS compatible) as defined above.

**Green (RoHS & no Sb/Br):** TI defines "Green" to mean Pb-Free (RoHS compatible), and free of Bromine (Br) and Antimony (Sb) based flame retardants (Br or Sb do not exceed 0.1% by weight in homogeneous material)

(3) MSL, Peak Temp. -- The Moisture Sensitivity Level rating according to the JEDEC industry standard classifications, and peak solder temperature.

(4) Multiple Top-Side Markings will be inside parentheses. Only one Top-Side Marking contained in parentheses and separated by a "~" will appear on a device. If a line is indented then it is a continuation of the previous line and the two combined represent the entire Top-Side Marking for that device.

**Important Information and Disclaimer:** The information provided on this page represents TI's knowledge and belief as of the date that it is provided. TI bases its knowledge and belief on information provided by third parties, and makes no representation or warranty as to the accuracy of such information. Efforts are underway to better integrate information from third parties. TI has taken and continues to take reasonable steps to provide representative and accurate information but may not have conducted destructive testing or chemical analysis on incoming materials and chemicals. TI and TI suppliers consider certain information to be proprietary, and thus CAS numbers and other limited information may not be available for release.

In no event shall TI's liability arising out of such information exceed the total purchase price of the TI part(s) at issue in this document sold by TI to Customer on an annual basis.

## TAPE AND REEL INFORMATION



### QUADRANT ASSIGNMENTS FOR PIN 1 ORIENTATION IN TAPE



\*All dimensions are nominal

Device	Package Type	Package Drawing	Pins	SPQ	Reel Diameter (mm)	Reel Width W1 (mm)	A0 (mm)	B0 (mm)	K0 (mm)	P1 (mm)	W (mm)	Pin1 Quadrant
LM48860TL/NOPB	DSBGA	YZR	12	250	178.0	8.4	1.68	2.13	0.76	4.0	8.0	Q1
LM48860TLX/NOPB	DSBGA	YZR	12	3000	178.0	8.4	1.68	2.13	0.76	4.0	8.0	Q1

**TAPE AND REEL BOX DIMENSIONS**



\*All dimensions are nominal

Device	Package Type	Package Drawing	Pins	SPQ	Length (mm)	Width (mm)	Height (mm)
LM48860TL/NOPB	DSBGA	YZR	12	250	210.0	185.0	35.0
LM48860TLX/NOPB	DSBGA	YZR	12	3000	210.0	185.0	35.0

YZR0012

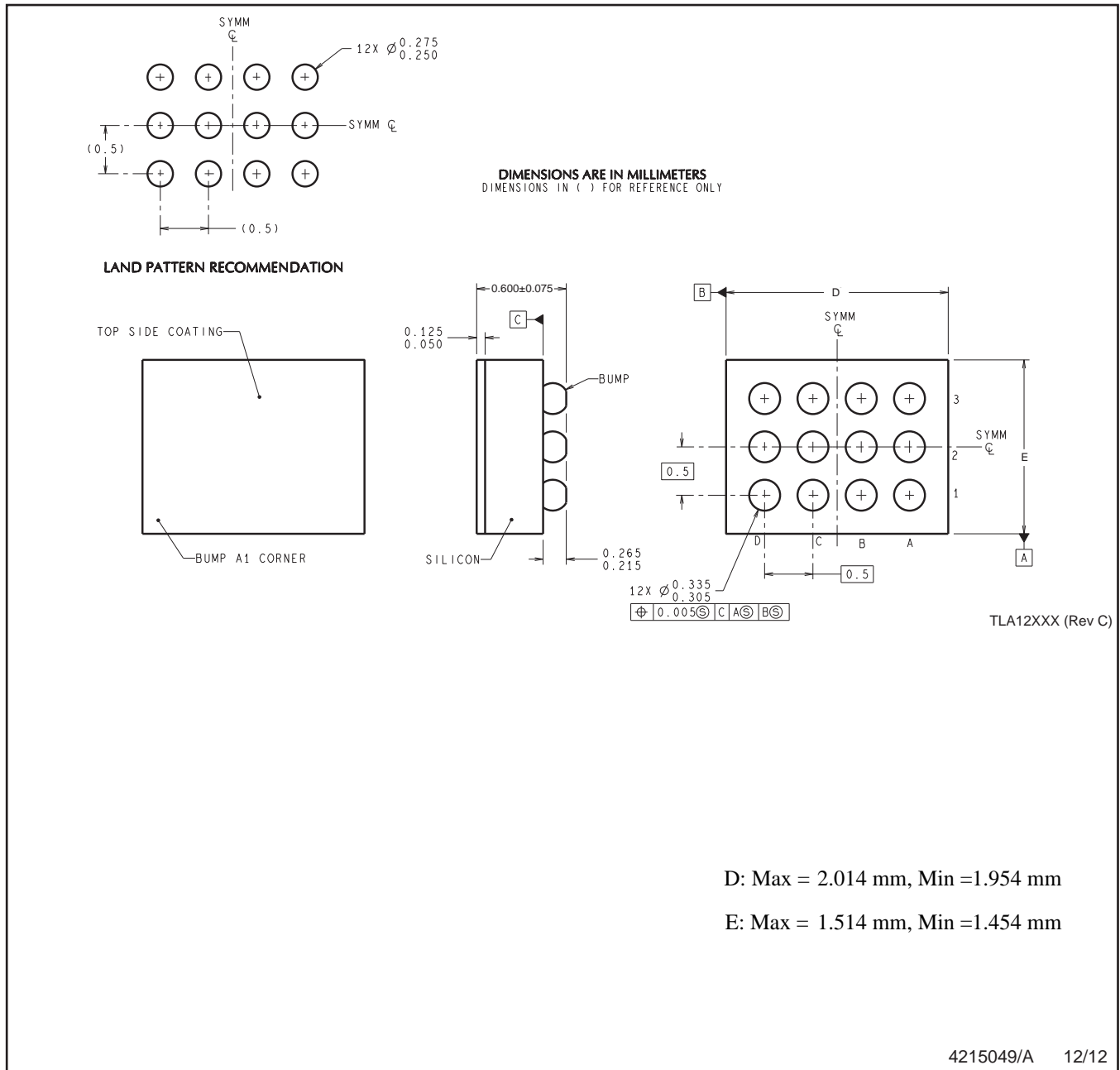

NOTES: A. All linear dimensions are in millimeters. Dimensioning and tolerancing per ASME Y14.5M-1994.  
B. This drawing is subject to change without notice.

## IMPORTANT NOTICE

Texas Instruments Incorporated and its subsidiaries (TI) reserve the right to make corrections, enhancements, improvements and other changes to its semiconductor products and services per JESD46, latest issue, and to discontinue any product or service per JESD48, latest issue. Buyers should obtain the latest relevant information before placing orders and should verify that such information is current and complete. All semiconductor products (also referred to herein as "components") are sold subject to TI's terms and conditions of sale supplied at the time of order acknowledgment.

TI warrants performance of its components to the specifications applicable at the time of sale, in accordance with the warranty in TI's terms and conditions of sale of semiconductor products. Testing and other quality control techniques are used to the extent TI deems necessary to support this warranty. Except where mandated by applicable law, testing of all parameters of each component is not necessarily performed.

TI assumes no liability for applications assistance or the design of Buyers' products. Buyers are responsible for their products and applications using TI components. To minimize the risks associated with Buyers' products and applications, Buyers should provide adequate design and operating safeguards.

TI does not warrant or represent that any license, either express or implied, is granted under any patent right, copyright, mask work right, or other intellectual property right relating to any combination, machine, or process in which TI components or services are used. Information published by TI regarding third-party products or services does not constitute a license to use such products or services or a warranty or endorsement thereof. Use of such information may require a license from a third party under the patents or other intellectual property of the third party, or a license from TI under the patents or other intellectual property of TI.

Reproduction of significant portions of TI information in TI data books or data sheets is permissible only if reproduction is without alteration and is accompanied by all associated warranties, conditions, limitations, and notices. TI is not responsible or liable for such altered documentation. Information of third parties may be subject to additional restrictions.

Resale of TI components or services with statements different from or beyond the parameters stated by TI for that component or service voids all express and any implied warranties for the associated TI component or service and is an unfair and deceptive business practice. TI is not responsible or liable for any such statements.

Buyer acknowledges and agrees that it is solely responsible for compliance with all legal, regulatory and safety-related requirements concerning its products, and any use of TI components in its applications, notwithstanding any applications-related information or support that may be provided by TI. Buyer represents and agrees that it has all the necessary expertise to create and implement safeguards which anticipate dangerous consequences of failures, monitor failures and their consequences, lessen the likelihood of failures that might cause harm and take appropriate remedial actions. Buyer will fully indemnify TI and its representatives against any damages arising out of the use of any TI components in safety-critical applications.

In some cases, TI components may be promoted specifically to facilitate safety-related applications. With such components, TI's goal is to help enable customers to design and create their own end-product solutions that meet applicable functional safety standards and requirements. Nonetheless, such components are subject to these terms.

No TI components are authorized for use in FDA Class III (or similar life-critical medical equipment) unless authorized officers of the parties have executed a special agreement specifically governing such use.

Only those TI components which TI has specifically designated as military grade or "enhanced plastic" are designed and intended for use in military/aerospace applications or environments. Buyer acknowledges and agrees that any military or aerospace use of TI components which have **not** been so designated is solely at the Buyer's risk, and that Buyer is solely responsible for compliance with all legal and regulatory requirements in connection with such use.

TI has specifically designated certain components as meeting ISO/TS16949 requirements, mainly for automotive use. In any case of use of non-designated products, TI will not be responsible for any failure to meet ISO/TS16949.

### Products

Audio	<a href="http://www.ti.com/audio">www.ti.com/audio</a>
Amplifiers	<a href="http://amplifier.ti.com">amplifier.ti.com</a>
Data Converters	<a href="http://dataconverter.ti.com">dataconverter.ti.com</a>
DLP® Products	<a href="http://www.dlp.com">www.dlp.com</a>
DSP	<a href="http://dsp.ti.com">dsp.ti.com</a>
Clocks and Timers	<a href="http://www.ti.com/clocks">www.ti.com/clocks</a>
Interface	<a href="http://interface.ti.com">interface.ti.com</a>
Logic	<a href="http://logic.ti.com">logic.ti.com</a>
Power Mgmt	<a href="http://power.ti.com">power.ti.com</a>
Microcontrollers	<a href="http://microcontroller.ti.com">microcontroller.ti.com</a>
RFID	<a href="http://www.ti-rfid.com">www.ti-rfid.com</a>
OMAP Applications Processors	<a href="http://www.ti.com/omap">www.ti.com/omap</a>
Wireless Connectivity	<a href="http://www.ti.com/wirelessconnectivity">www.ti.com/wirelessconnectivity</a>

### Applications

Automotive and Transportation	<a href="http://www.ti.com/automotive">www.ti.com/automotive</a>
Communications and Telecom	<a href="http://www.ti.com/communications">www.ti.com/communications</a>
Computers and Peripherals	<a href="http://www.ti.com/computers">www.ti.com/computers</a>
Consumer Electronics	<a href="http://www.ti.com/consumer-apps">www.ti.com/consumer-apps</a>
Energy and Lighting	<a href="http://www.ti.com/energy">www.ti.com/energy</a>
Industrial	<a href="http://www.ti.com/industrial">www.ti.com/industrial</a>
Medical	<a href="http://www.ti.com/medical">www.ti.com/medical</a>
Security	<a href="http://www.ti.com/security">www.ti.com/security</a>
Space, Avionics and Defense	<a href="http://www.ti.com/space-avionics-defense">www.ti.com/space-avionics-defense</a>
Video and Imaging	<a href="http://www.ti.com/video">www.ti.com/video</a>

### TI E2E Community

[e2e.ti.com](http://e2e.ti.com)