

LM48410 Boomer® Audio Power Amplifier Series **Low EMI, Filterless, 2.3W Stereo Class D Audio Power Amplifier with 3D Enhancement**

Check for Samples: [LM48410](#)

FEATURES

- **Selectable Spread Spectrum Mode Reduces EMI**
- **Output Short Circuit Protection**
- **Stereo Class D Operation**
- **No Output Filter Required**
- **3D Enhancement**
- **Logic Selectable Gain**
- **Independent Channel Shutdown Controls**
- **Minimum External Components**
- **Click and Pop Suppression**
- **Micro-Power Shutdown**
- **Available in Space-Saving 4mm x 4mm WQFN Package**

APPLICATIONS

- **Mobile Phones**
- **PDA's**
- **Laptops**

KEY SPECIFICATIONS

- **Quiescent Power Supply Current at 3.6V supply 4mA**
- **Power Output at $V_{DD} = 5V$, $R_L = 4\Omega$, THD $\leq 10\%$ 2.3W (typ)**
- **Power Output at $V_{DD} = 5V$, $R_L = 8\Omega$, THD $\leq 10\%$ 1.5W (typ)**
- **Shutdown current 0.03 μ A (typ)**
- **Efficiency at 3.6V, 100mW into 8 Ω 80% (typ)**
- **Efficiency at 3.6V, 500mW into 8 Ω 85% (typ)**
- **Efficiency at 5V, 1W into 8 Ω 86% (typ)**

DESCRIPTION

The LM48410 is a single supply, high efficiency, 2.3W/channel, filterless switching audio amplifier. A low noise PWM architecture eliminates the output filter, reducing external component count, board area consumption, system cost, and simplifying design. A selectable spread spectrum modulation scheme suppresses RF emissions, further reducing the need for output filters.

The LM48410 is designed to meet the demands of mobile phones and other portable communication devices. Operating from a single 5V supply, the device is capable of delivering 2.3W/channel of continuous output power to a 4 Ω load with less than 10% THD+N. Flexible power supply requirements allow operation from 2.4V to 5.5V. The LM48410 offers two logic selectable modulation schemes, fixed frequency mode, and an EMI reducing spread spectrum mode.

The LM48410 features high efficiency compared with conventional Class AB amplifiers. When driving an 8 Ω speaker from a 3.6V supply, the device operates with 85% efficiency at $P_O = 500\text{mW/Ch}$. Four gain options are pin selectable through the G0 and G1 pins. The LM48410 also includes 3D audio enhancement that improves stereo sound quality. In devices where the left and right speakers are in close proximity, 3D enhancement affects channel specialization, widening the perceived soundstage.

Output short circuit protection prevents the device from being damaged during fault conditions. Superior click and pop suppression eliminates audible transients on power-up/down and during shutdown. Independent left/right shutdown controls maximizes power savings in mixed mono/stereo applications.



Please be aware that an important notice concerning availability, standard warranty, and use in critical applications of Texas Instruments semiconductor products and disclaimers thereto appears at the end of this data sheet.

All trademarks are the property of their respective owners.

EMI Plot

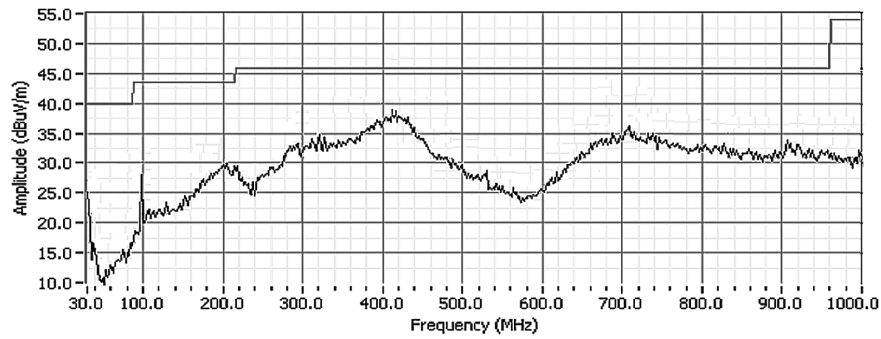

Typical Application

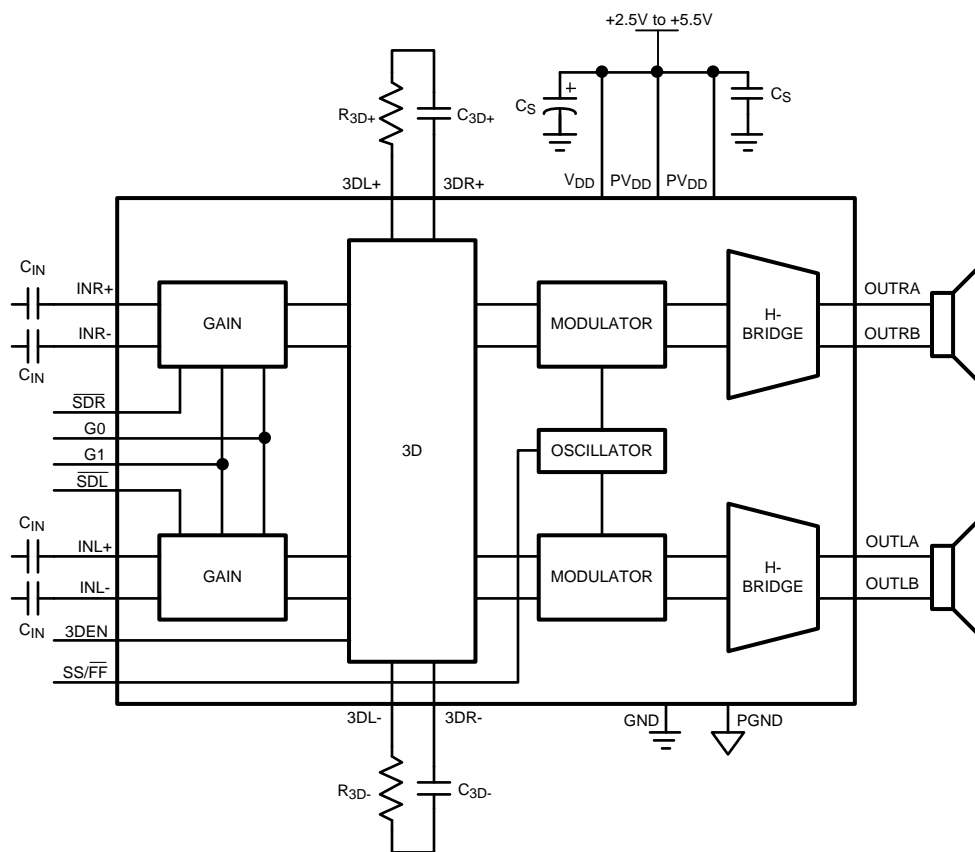
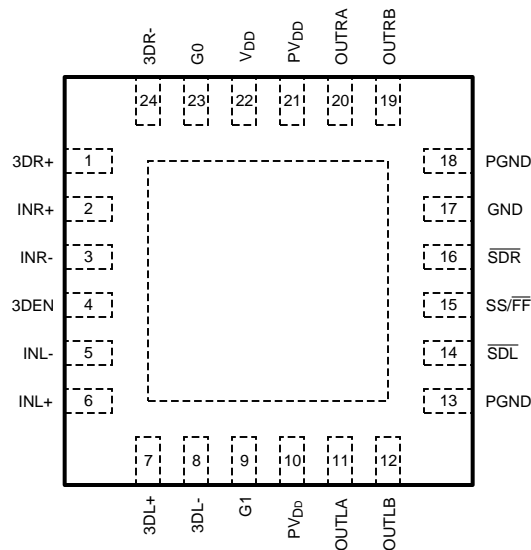

Figure 1. Typical Audio Amplifier Application Circuit

Connection Diagram



**Figure 2. 24-Lead WQFN
4mm x 4mm x 0.8mm - Top View
See RTW0024A Package**

PIN DESCRIPTIONS

Pin	Name	Description
1	3DR+	Right Channel non-inverting 3D connection. Connect to 3DL+ through C _{3D+} and R _{3D+}
2	INR+	Right Channel Non-Inverting Input
3	INR-	Right Channel Inverting Input
4	3DEN	3D Enable Input
5	INL-	Left Channel Inverting Input
6	INL+	Left Channel Non-Inverting Input
7	3DL+	Left Channel non-inverting 3D connection. Connect to 3DR+ through C _{3D+} and R _{3D+}
8	3DL-	Left Channel inverting 3D connection. Connect to 3DR- through C _{3D-} and R _{3D-}
9	G1	Gain Select Input 1
10, 21	PV _{DD}	Speaker Power Supply
11	OUTLA	Left Channel Non-Inverting Output
12	OUTLB	Left Channel Inverting Output
13, 18	PGND	Power Ground
14	$\overline{\text{SDL}}$	Left Channel Active Low Shutdown. Connect to V _{DD} for normal operation. Connect to GND to disable the left channel.
15	SS/ $\overline{\text{FF}}$	Modulation Mode Select. Connect to V _{DD} for spread spectrum mode. Connect to GND for fixed frequency mode
16	$\overline{\text{SDR}}$	Right Channel Active Low Shutdown. Connect to V _{DD} for normal operation. Connect to GND to disable the right channel.
17	GND	Ground
19	OUTRB	Right Channel Inverting Output

PIN DESCRIPTIONS (continued)

Pin	Name	Description
20	OUTRA	Right Channel Non-Inverting Output
22	V _{DD}	Power Supply
23	G0	Gain Select Input 0
24	3DR-	Right Channel inverting 3D connection. Connect to 3DL- through C _{3D} and R _{3D} -.



These devices have limited built-in ESD protection. The leads should be shorted together or the device placed in conductive foam during storage or handling to prevent electrostatic damage to the MOS gates.

Absolute Maximum Ratings⁽¹⁾⁽²⁾⁽³⁾

Supply Voltage ⁽¹⁾		6.0V
Storage Temperature		-65°C to +150°C
Input Voltage		-0.3V to V _{DD} +0.3V
Power Dissipation ⁽⁴⁾		Internally Limited
ESD Susceptibility ⁽⁵⁾		2000V
ESD Susceptibility ⁽⁶⁾		200V
Junction Temperature		150°C
Thermal Resistance	θ_{JC}	5.3°C/W
	θ_{JA}	36.5°C/W

- (1) All voltages are measured with respect to the ground pin, unless otherwise specified.
- (2) *Absolute Maximum Ratings* indicate limits beyond which damage to the device may occur. *Operating Ratings* indicate conditions for which the device is functional, but do not ensure specific performance limits. *Electrical Characteristics* state DC and AC electrical specifications under particular test conditions which ensure specific performance limits. This assumes that the device is within the Operating Ratings. Specifications are not ensured for parameters where no limit is given, however, the typical value is a good indication of device performance.
- (3) \dot{a}
- (4) The maximum power dissipation must be derated at elevated temperatures and is dictated by T_{JMAX}, θ_{JA} , and the ambient temperature, T_A. The maximum allowable power dissipation is P_{DMAX} = (T_{JMAX} - T_A) / θ_{JA} or the number given in Absolute Maximum Ratings, whichever is lower.
- (5) Human body model, 100pF discharged through a 1.5k Ω resistor.
- (6) Machine Model, 220pF–240pF discharged through all pins.

Operating Ratings⁽¹⁾⁽²⁾

Temperature Range T _{MIN} ≤ T _A ≤ T _{MAX}		-40°C ≤ T _A ≤ 85°C
Supply Voltage (V _{DD} , PV _{DD})		2.4V ≤ V _{DD} ≤ 5.5V

- (1) All voltages are measured with respect to the ground pin, unless otherwise specified.
- (2) *Absolute Maximum Ratings* indicate limits beyond which damage to the device may occur. *Operating Ratings* indicate conditions for which the device is functional, but do not ensure specific performance limits. *Electrical Characteristics* state DC and AC electrical specifications under particular test conditions which ensure specific performance limits. This assumes that the device is within the Operating Ratings. Specifications are not ensured for parameters where no limit is given, however, the typical value is a good indication of device performance.

Electrical Characteristics $V_{DD} = PV_{DD} = 3.6V^{(1)(2)}$

The following specifications apply for $A_V = 6dB$, $R_L = 15\mu H + 8\Omega + 15\mu H$, $SS/\overline{FF} = V_{DD}$ (Spread Spectrum mode), $f = 1kHz$, unless otherwise specified. Limits apply for $T_A = 25^\circ C$.

Symbol	Parameter	Conditions	LM48410		Units (Limits)
			Typical ⁽³⁾	Limit ⁽⁴⁾⁽⁵⁾	
V_{OS}	Differential Output Offset Voltage	$V_{IN} = 0$, $V_{DD} = 2.4V$ to $5.0V$	5		mV
I_{DD}	Quiescent Power Supply Current	$V_{IN} = 0$, No Load			
		Both channels active, $V_{DD} = 3.6V$	4	6.5	mA (max)
		$V_{DD} = 5V$	5	8.5	mA (max)
I_{SD}	Shutdown Current	$V_{SDL} = V_{SDR} = GND$	0.03	1	μA (max)
V_{IH}	Logic Input High Voltage			1.4	V (min)
V_{IL}	Logic Input Low Voltage			0.4	V (max)
T_{WU}	Wake Up Time		4		ms
f_{SW}	Switching Frequency	$SS/\overline{FF} = V_{DD}$ (Spread Spectrum)	300	390	kHz (max)
		$SS/\overline{FF} = GND$ (Fixed Frequency)	300		kHz
A_V	Gain	$G0, G1 = GND$, $R_L = \infty$	6	5.5	dB (min)
		6.5		dB (max)	
		$G0 = V_{DD}$, $G1 = GND$	12	11.5	dB (min)
		12.5		dB (max)	
		$G0 = GND$, $G1 = V_{DD}$	18	17.5	dB (min)
18.5	dB (max)				
$G0, G1 = V_{DD}$	24	23.5	dB (min)		
24.5		dB (max)			
R_{IN}	Input Resistance	$A_V = 6dB$	160		k Ω
		$A_V = 12dB$	80		k Ω
		$A_V = 18dB$	40		k Ω
		$A_V = 24dB$	20		k Ω

- (1) All voltages are measured with respect to the ground pin, unless otherwise specified.
- (2) *Absolute Maximum Ratings* indicate limits beyond which damage to the device may occur. *Operating Ratings* indicate conditions for which the device is functional, but do not ensure specific performance limits. *Electrical Characteristics* state DC and AC electrical specifications under particular test conditions which ensure specific performance limits. This assumes that the device is within the Operating Ratings. Specifications are not ensured for parameters where no limit is given, however, the typical value is a good indication of device performance.
- (3) Typicals are measured at $25^\circ C$ and represent the parametric norm.
- (4) Limits are specified to TI's AOQL (Average Outgoing Quality Level).
- (5) Datasheet min/max specification limits are specified by design, test, or statistical analysis.

Electrical Characteristics $V_{DD} = PV_{DD} = 3.6V^{(1)(2)}$ (continued)

The following specifications apply for $A_V = 6dB$, $R_L = 15\mu H + 8\Omega + 15\mu H$, $SS/\overline{FF} = V_{DD}$ = (Spread Spectrum mode), $f = 1kHz$, unless otherwise specified. Limits apply for $T_A = 25^\circ C$.

Symbol	Parameter	Conditions	LM48410		Units (Limits)
			Typical ⁽³⁾	Limit ⁽⁴⁾⁽⁵⁾	
P_O	Output Power (Per Channel)	$R_L = 15\mu H + 4\Omega + 15\mu H$, THD $\leq 10\%$ $f = 1kHz$, 22kHz BW			
		$V_{DD} = 5V$	2.3		W
		$V_{DD} = 3.6V$	1.14		W
		$V_{DD} = 2.5V$	490		mW
		$R_L = 15\mu H + 8\Omega + 15\mu H$, THD $\leq 10\%$ $f = 1kHz$, 22kHz BW			
		$V_{DD} = 5V$	1.5		W
		$V_{DD} = 3.6V$	740	600	mW (min)
		$V_{DD} = 2.5V$	330		mW
		$R_L = 15\mu H + 4\Omega + 15\mu H$, THD $\leq 1\%$ $f = 1kHz$, 22kHz BW			
		$V_{DD} = 5V$	1.85		W
		$V_{DD} = 3.6V$	940		mW
		$V_{DD} = 2.5V$	400		mW
		$R_L = 15\mu H + 8\Omega + 15\mu H$, THD = 1% $f = 1kHz$, 22kHz BW			
		$V_{DD} = 5V$	1.18		W
		$V_{DD} = 3.6V$	580		mW
		$V_{DD} = 2.5V$	270		mW
THD+N	Total Harmonic Distortion	$P_O = 500mW/Ch$, $f = 1kHz$, $R_L = 8\Omega$	0.025		%
		$P_O = 300mW/Ch$, $f = 1kHz$, $R_L = 8\Omega$	0.07		%
PSRR	Power Supply Rejection Ratio	$V_{RIPPLE} = 200mV_{P-P}$ Sine, Inputs AC GND, $C_{IN} = 1\mu F$, input referred $f_{RIPPLE} = 217Hz$ $f_{RIPPLE} = 1kHz$,	70		dB
			68		dB
CMRR	Common Mode Rejection Ratio	$V_{RIPPLE} = 1V_{P-P}$ $f_{RIPPLE} = 217Hz$	65		dB
η	Efficiency	$P_O = 1W/Ch$, $f = 1kHz$, $R_L = 8\Omega$, $V_{DD} = 5V$	86		%
Xtalk	Crosstalk	$P_O = 500mW/Ch$, $f = 1kHz$	82		dB
SNR	Signal to Noise Ratio	$V_{DD} = 5V$, $P_O = 1W$ Fixed Frequency Mode	88		dB
ϵ_{OS}	Output Noise	Input referred, Fixed Frequency Mode A-Weighted Filter	28		μV

Typical Performance Characteristics

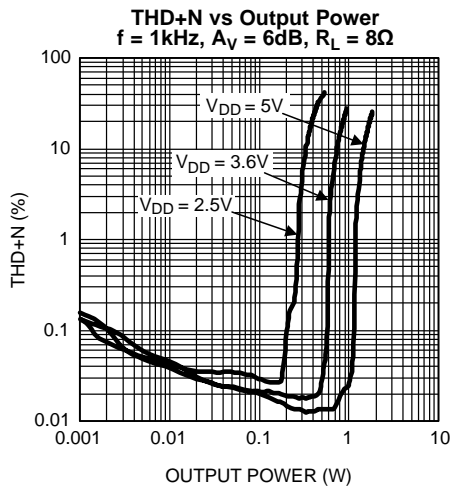

Figure 3.

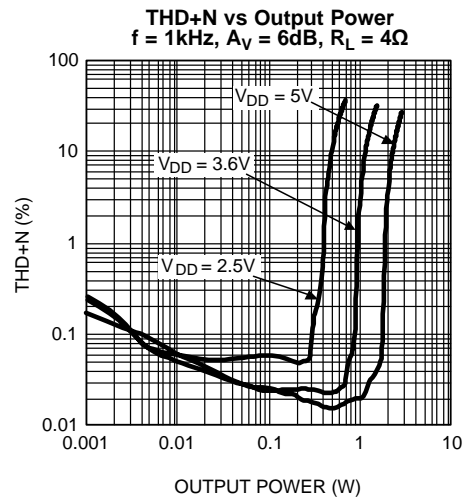

Figure 4.

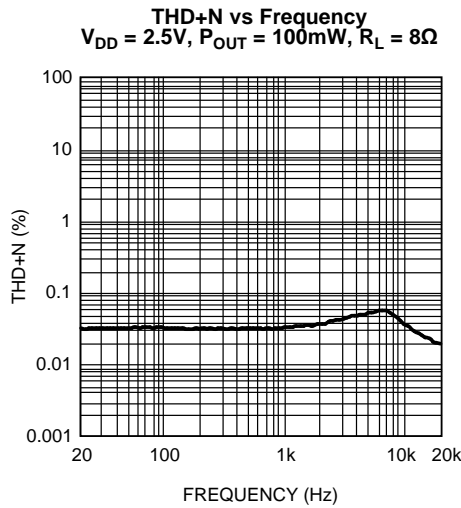

Figure 5.

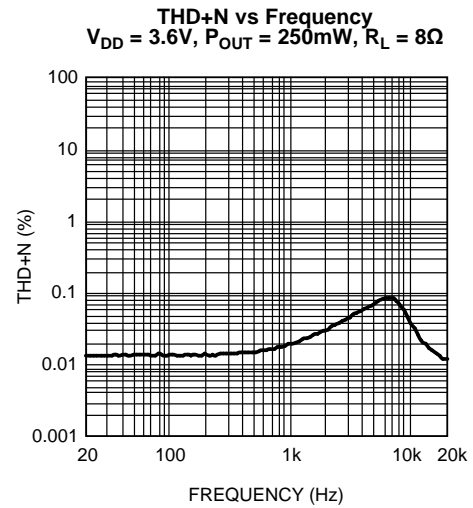

Figure 6.

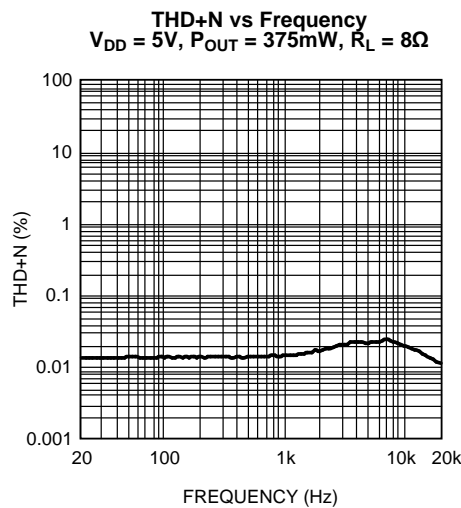

Figure 7.

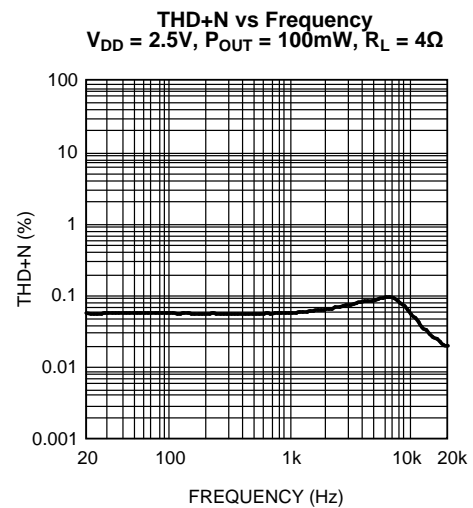

Figure 8.

Typical Performance Characteristics (continued)

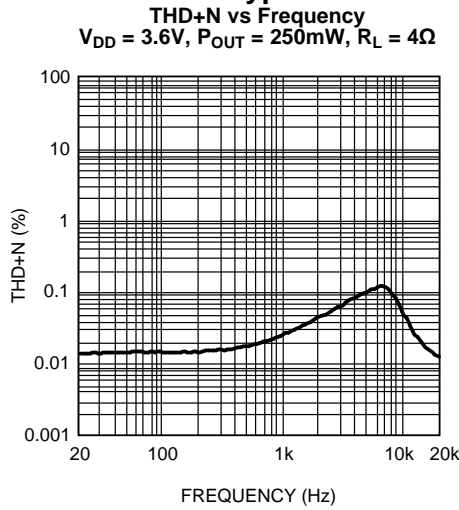

Figure 9.

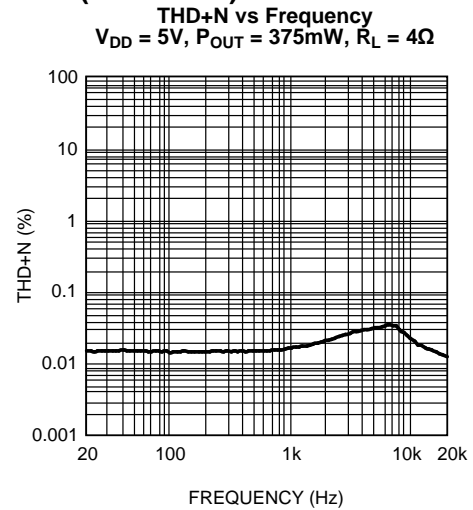

Figure 10.

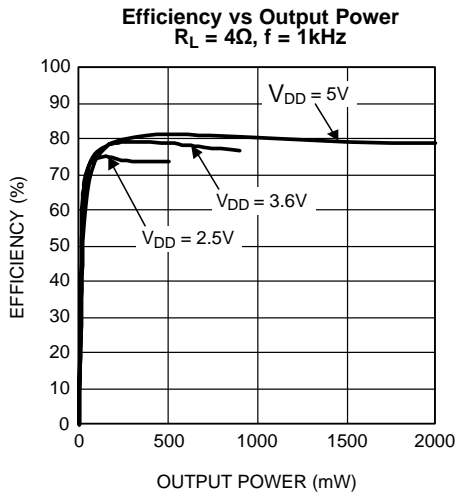

Figure 11.

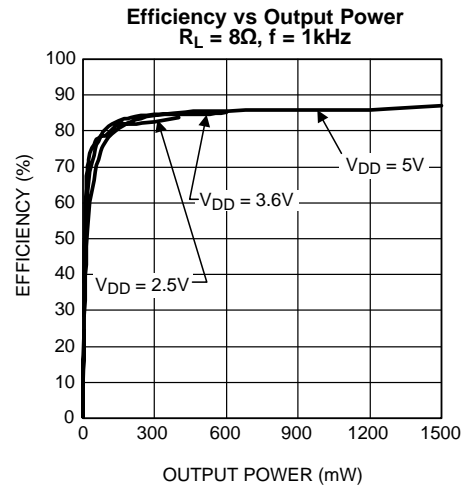

Figure 12.

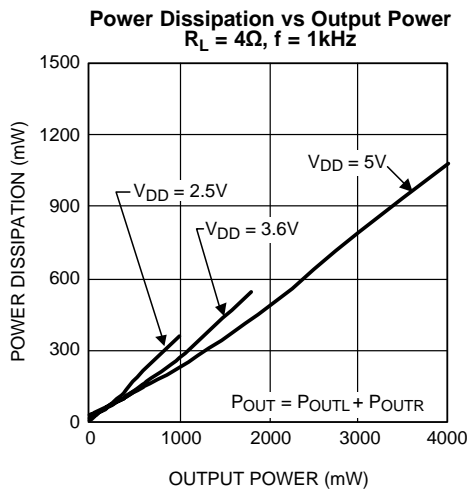

Figure 13.

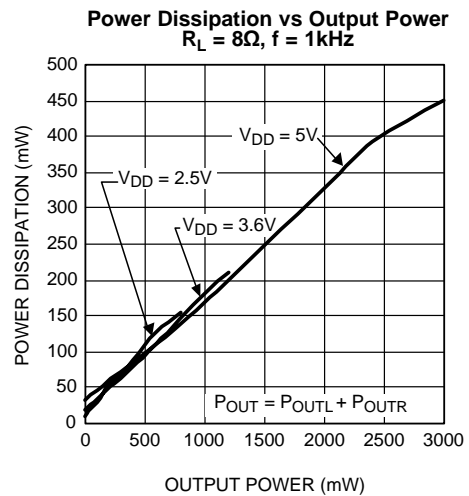

Figure 14.

Typical Performance Characteristics (continued)

Output Power vs Supply Voltage
 $R_L = 4\Omega, f = 1\text{kHz}$

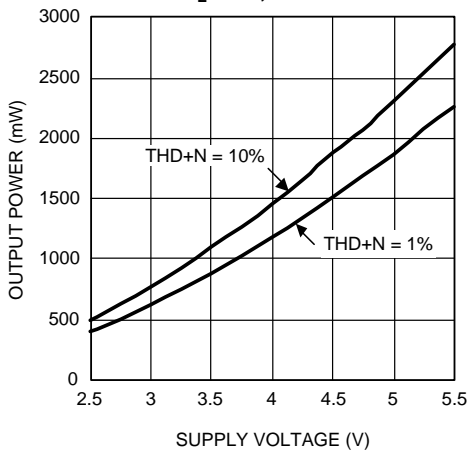

Figure 15.

Output Power vs Supply Voltage
 $R_L = 8\Omega, f = 1\text{kHz}$

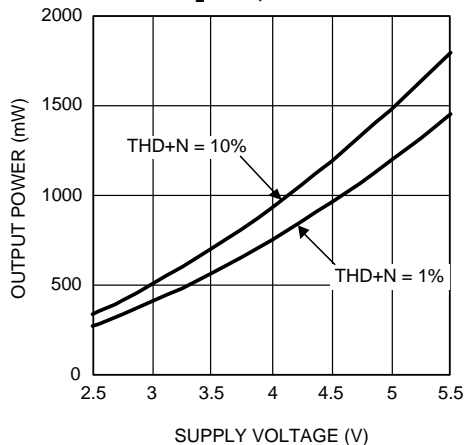

Figure 16.

PSRR vs Frequency
 $V_{DD} = 3.6\text{V}, V_{RIPPLE} = 200\text{mV}_{P-P}, R_L = 8\Omega$

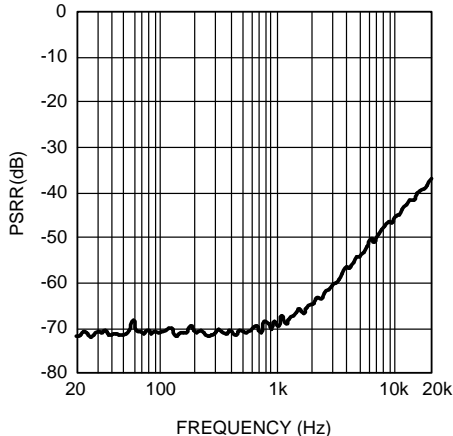

Figure 17.

Crosstalk vs Frequency
 $V_{DD} = 3.6\text{V}, V_{RIPPLE} = 1\text{V}_{P-P}, R_L = 8\Omega$

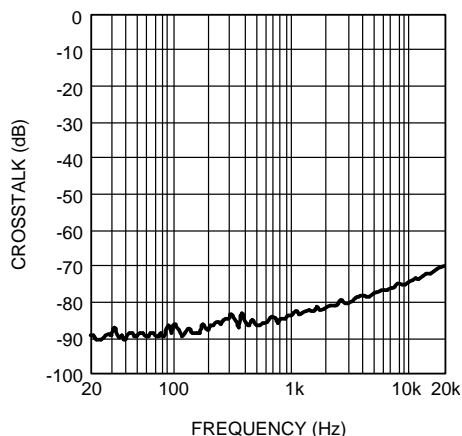

Figure 18.

CMRR vs Frequency
 $V_{DD} = 3.6\text{V}, V_{CM} = 1\text{V}_{P-P}, R_L = 8\Omega$

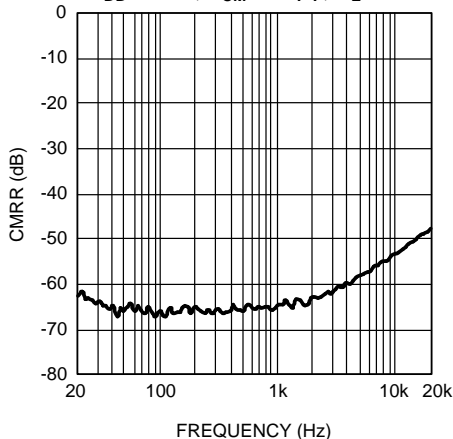

Figure 19.

Supply Current vs Supply Voltage
 No Load

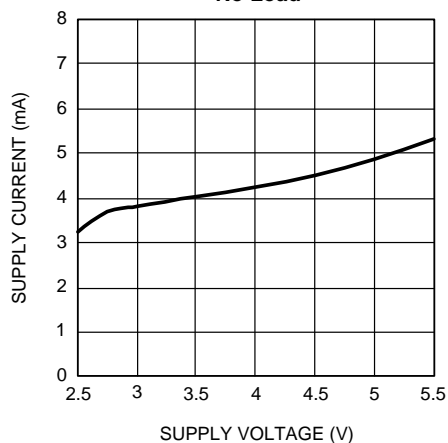

Figure 20.

Typical Performance Characteristics (continued)
 Fixed Frequency FFT Spread Spectrum FFT
 $V_{DD} = 3.6V$ $V_{DD} = 3.6V$

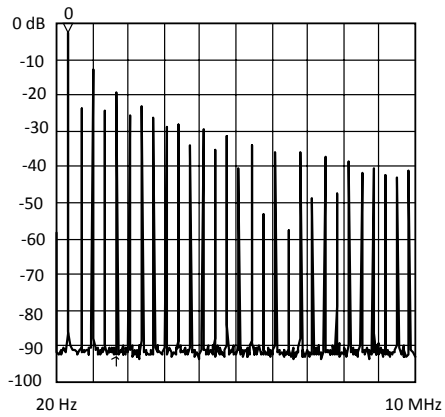

Figure 21.

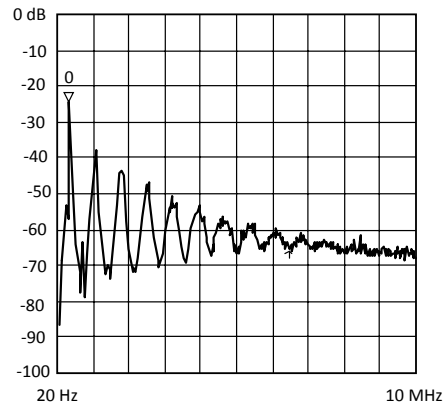

Figure 22.

APPLICATION INFORMATION

GENERAL AMPLIFIER FUNCTION

The LM48410 stereo Class D audio power amplifier features a filterless modulation scheme that reduces external component count, conserving board space and reducing system cost. The outputs of the device transition from V_{DD} to GND with a 300kHz switching frequency. With no signal applied, the outputs switch with a 50% duty cycle, in phase, causing the two outputs to cancel. This cancellation results in no net voltage across the speaker, thus there is no current to the load in the idle state.

When an input signal is applied, the duty cycle (pulse width) of the LM48410 output's change. For increasing output voltage, the duty cycle of one side of each output increases, while the duty cycle of the other side of each output decreases. For decreasing output voltages, the converse occurs. The difference between the two pulse widths yields the differential output voltage.

FIXED FREQUENCY MODE

The LM48410 features two modulations schemes, a fixed frequency mode and a spread spectrum mode. Select the fixed frequency mode by setting $SS/\overline{FF} = \text{GND}$. In fixed frequency mode, the amplifier outputs switch at a constant 300kHz. In fixed frequency mode, the output spectrum consists of the fundamental and its associated harmonics (see [Typical Performance Characteristics](#)).

SPREAD SPECTRUM

The logic selectable spread spectrum mode eliminates the need for output filters, ferrite beads or chokes. In spread spectrum mode, the switching frequency varies randomly by 30% about a 300kHz center frequency, reducing the wideband spectral content and improving EMI emissions radiated by the speaker and associated cables and traces. A fixed frequency class D exhibits large amounts of spectral energy at multiples of the switching frequency. The spread spectrum architecture of the LM48410 spreads the same energy over a larger bandwidth (See [Typical Performance Characteristics](#)). The cycle-to-cycle variation of the switching period does not affect the audio reproduction, efficiency, or PSRR. Set $SS/\overline{FF} = V_{DD}$ for spread spectrum mode.

DIFFERENTIAL AMPLIFIER EXPLANATION

As logic supplies continue to shrink, system designers are increasingly turning to differential analog signal handling to preserve signal to noise ratios with restricted voltage swings. The LM48410 features two fully differential speaker amplifiers. A differential amplifier amplifies the difference between the two input signals. Traditional audio power amplifiers have typically offered only single-ended inputs resulting in a 6dB reduction of SNR relative to differential inputs. The LM48410 also offers the possibility of DC input coupling which eliminates the input coupling capacitors. A major benefit of the fully differential amplifier is the improved common mode rejection ratio (CMRR) over single-ended input amplifiers. The increased CMRR of the differential amplifier reduces sensitivity to ground offset related noise injection, especially important in noisy systems.

POWER DISSIPATION AND EFFICIENCY

The major benefit of a Class D amplifier is increased efficiency versus a Class AB. The efficiency of the LM48410 is attributed to the region of operation of the transistors in the output stage. The Class D output stage acts as current steering switches, consuming negligible amounts of power compared to a Class AB amplifier. Most of the power loss associated with the output stage is due to the IR loss of the MOSFET on-resistance, along with switching losses due to gate charge.

SHUTDOWN FUNCTION

The LM48410 features independent left and right channel shutdown controls, allowing each channel to be disabled independently. \overline{SDR} controls the right channel, while \overline{SDL} controls the left channel. Driving either low disables the corresponding channel, reducing supply current to 0.1 μ A.

It is best to switch between ground and V_{DD} for minimum current consumption while in shutdown. The LM48410 may be disabled with shutdown voltages in between GND and V_{DD} , the idle current will be greater than the typical 0.1 μ A value.

The LM48410 shutdown inputs have internal pulldown resistors. The purpose of these resistors is to eliminate any unwanted state changes when \overline{SD} is floating. To minimize shutdown current, \overline{SD} should be driven to GND or left floating. If \overline{SD} is not driven to GND or floating, an increase in shutdown supply current will be noticed.

PROPER SELECTION OF EXTERNAL COMPONENTS

Power Supply Bypassing/Filtering

Proper power supply bypassing is important for low noise performance and high PSRR. Place the supply bypass capacitor as close to the device as possible. Typical applications employ a voltage regulator with 10 μ F and 0.1 μ F bypass capacitors that increase supply stability. These capacitors do not eliminate the need for bypassing of the LM48410 supply pins. A 1 μ F capacitor is recommended.

Input Capacitor Selection

Input capacitors may be required for some applications, or when the audio source is single-ended. Input capacitors block the DC component of the audio signal, eliminating any conflict between the DC component of the audio source and the bias voltage of the LM48410. The input capacitors create a high-pass filter with the input resistance R_{IN} . The -3dB point of the high-pass filter is found using [Equation 1](#) below.

$$f = 1 / 2\pi R_{IN} C_{IN} \quad (1)$$

The values for R_{IN} can be found in the [Electrical Characteristics](#) table for each gain setting.

The input capacitors can also be used to remove low frequency content from the audio signal. Small speakers cannot reproduce, and may even be damaged by low frequencies. High-pass filtering the audio signal helps protect the speakers. When the LM48410 is using a single-ended source, power supply noise on the ground is seen as an input signal. Setting the high-pass filter point above the power supply noise frequencies, 217 Hz in a GSM phone, for example, filters out the noise such that it is not amplified and heard on the output. Capacitors with a tolerance of 10% or better are recommended for impedance matching and improved CMRR and PSRR.

3D Enhancement

The LM48410 features TI's 3D enhancement effect that widens the perceived soundstage of a stereo audio signal. The 3D enhancement increases the apparent stereo channel separation, improving audio reproduction whenever the left and right speakers are too close to one another.

An external RC network shown in [Figure 1](#) is required to enable the 3D effect. Because the LM48410 is a fully differential amplifier, there are two separate RC networks, one for each stereo input pair (INL+ and INR+, and INL- and INR-). Set 3DEN high to enable the 3D effect. Set 3DEN low to disable the 3D effect.

The 3D RC network acts as a high pass filter. The amount of the 3D effect is set by the R_{3D} resistor. Decreasing the value of R_{3D} increases the 3D effect. The C_{3D} capacitor sets the frequency at which the 3D effect occurs. Increasing the value of C_{3D} decreases the low frequency cutoff point, extending the 3D effect over a wider bandwidth. The low frequency cutoff point is given by:

$$f_{3D(-3dB)} = 1 / 2\pi(R_{3D})(C_{3D}) \quad (2)$$

Enabling the 3D effect increase the gain by a factor of $(1+20k\Omega/R_{3D})$. Setting R_{3D} to 20k Ω results in a gain increase of 6dB whenever the 3D effect is enabled. In fully differential configuration, the component values of the two RC networks must be identical. Any component variations can affect the sound quality of the 3D effect. In single-ended configuration, only the RC network of the input pairs being driven by the audio source needs to be connected. For instance, if audio is applied to INR+ and INL+, then a 3D network must be connected between 3DL+ and 3DR+. 3DL- and 3DR- can be left unconnected.

AUDIO AMPLIFIER GAIN SETTING

The LM48410 features four internally configured gain settings. The device gain is selected through the two logic inputs, G0 and G1. The gain settings are as shown in the following table.

LOGIC INPUT		GAIN	
G1	G0	V/V	dB
0	0	2	6
0	1	4	12
1	0	8	18
1	1	16	24

SINGLE-ENDED AUDIO AMPLIFIER CONFIGURATION

The LM48410 is compatible with single-ended sources. When configured for single-ended inputs, input capacitors must be used to block and DC component at the input of the device. Figure 23 shows the typical single-ended applications circuit.

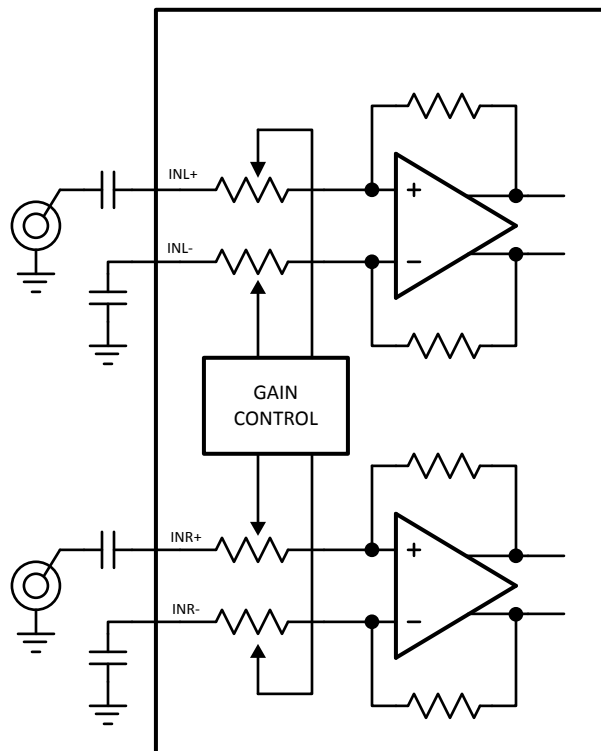

Figure 23. Single-Ended Circuit Diagram

PCB LAYOUT GUIDELINES

As output power increases, interconnect resistance (PCB traces and wires) between the amplifier, load and power supply create a voltage drop. The voltage loss due to the traces between the LM48410 and the load results in lower output power and decreased efficiency. Higher trace resistance between the supply and the LM48410 has the same effect as a poorly regulated supply, increasing ripple on the supply line, and reducing peak output power. The effects of residual trace resistance increases as output current increases due to higher output power, decreased load impedance or both. To maintain the highest output voltage swing and corresponding peak output power, the PCB traces that connect the output pins to the load and the supply pins to the power supply should be as wide as possible to minimize trace resistance.

The use of power and ground planes will give the best THD+N performance. In addition to reducing trace resistance, the use of power planes creates parasitic capacitors that help to filter the power supply line.

The inductive nature of the transducer load can also result in overshoot on one or both edges, clamped by the parasitic diodes to GND and V_{DD} in each case. From an EMI standpoint, this is an aggressive waveform that can radiate or conduct to other components in the system and cause interference. It is essential to keep the power and output traces short and well shielded if possible. Use of ground planes, beads, and micro-strip layout techniques are all useful in preventing unwanted interference.

As the distance from the LM48410 and the speaker increases, the amount of EMI radiation increases due to the output wires or traces acting as antennas. An antenna becomes a more efficient radiator with length. Ferrite chip inductors placed close to the LM48410 outputs may be needed to reduce EMI radiation.

EXPOSED-DAP MOUNTING CONSIDERATIONS

The LM48410 WQFN package features an exposed thermal pad on its underside (DAP, or die attach paddle). The exposed DAP lowers the package's thermal resistance by providing a direct heat conduction path from the die to the printed circuit board. Connect the exposed thermal pad to GND through a large pad and multiple vias to a GND plane on the bottom of the PCB.

Bill of Materials

Table 1. LM48410SQ Demo Board Bill of Materials

Designation	Qty	Description	Recommended Manufacturer	Part Number
C1–C4	4	1 μ F \pm 10%, 16V X7R ceramic capacitors (1206)	Panasonic	ECJ-3YB1C105K
C5–C9	5	1 μ F \pm 10%, 16V X7R ceramic capacitors (603)	Panasonic	ECJ-1VB1C105K
C10	1	1 μ F \pm 10%, 16V X7R tantalum capacitors (B-case)	AVX	TPSB106K016R0800
R1, R2	2	82k Ω \pm 5% resistor (603)		
R3, R4	2	100k Ω potentiometer		ST4B104CT
T1, T2	2	Common mode choke, A1, 800 Ω at 100kHz	TDK	ACM4532–801
JU1–JU6	6	3–pin header		
U1		LM48410SQ (24–pin SQA, 4mm x 4mm x 0.8mm)	Texas Instruments	

LM48410 Demonstration Board Schematic Diagram

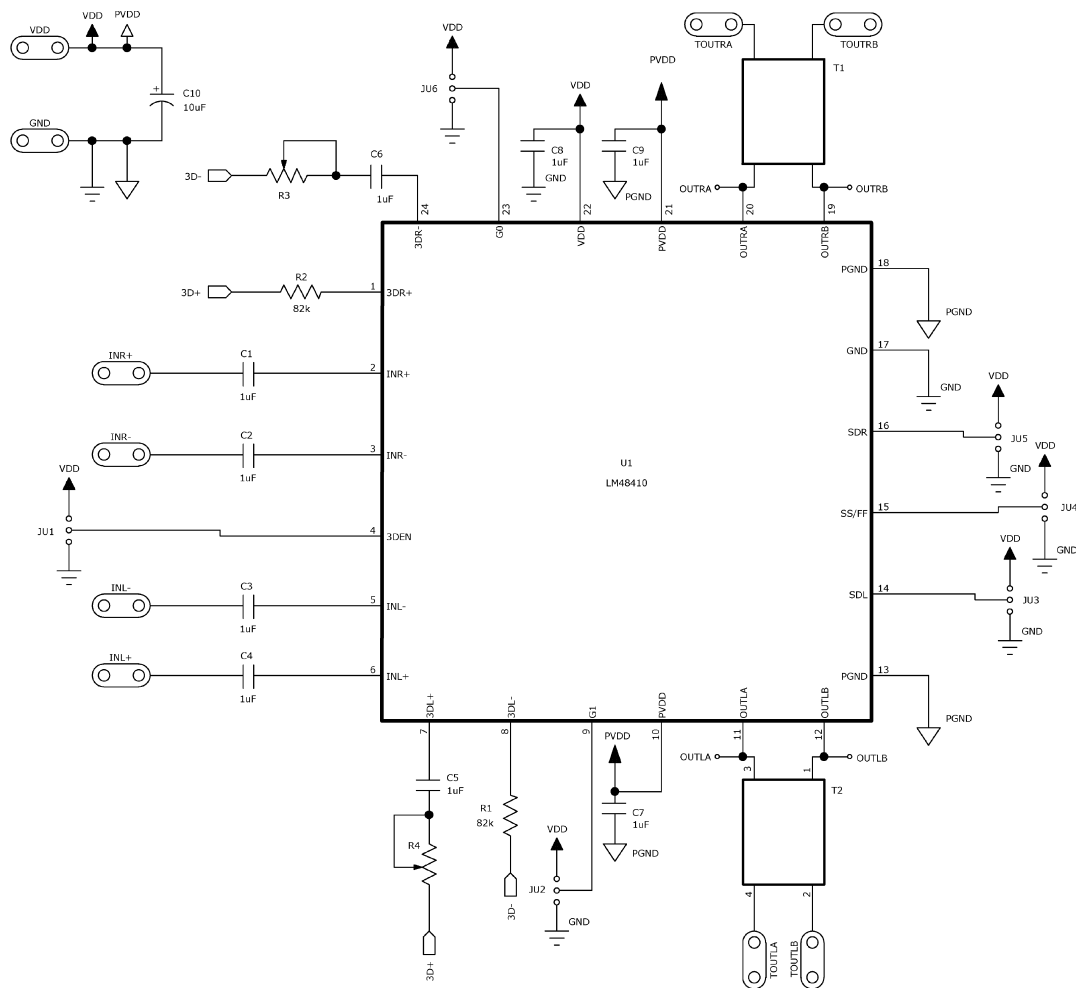

Demoboard PCB Layout

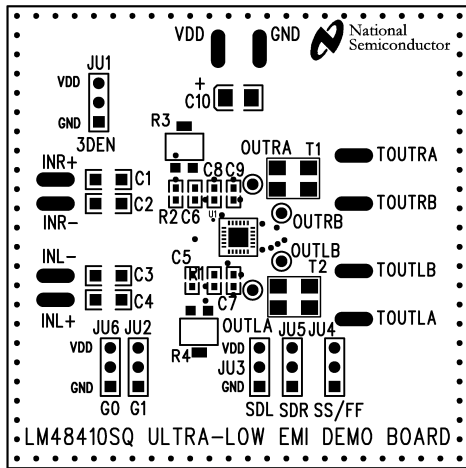

Figure 24. Top Silkscreen

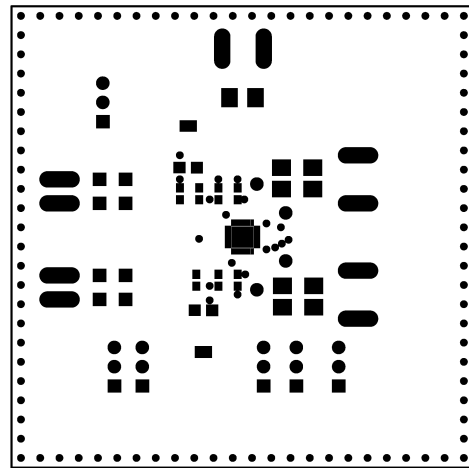

Figure 25. Top Soldermask

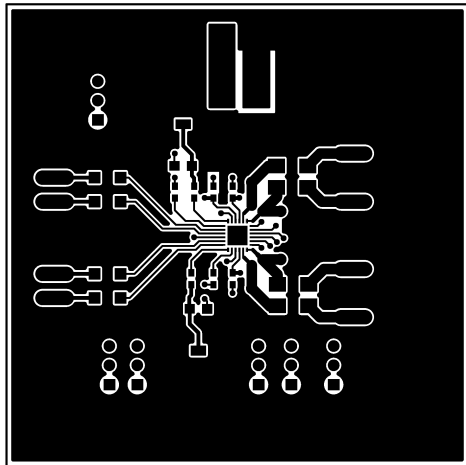

Figure 26. Top Layer

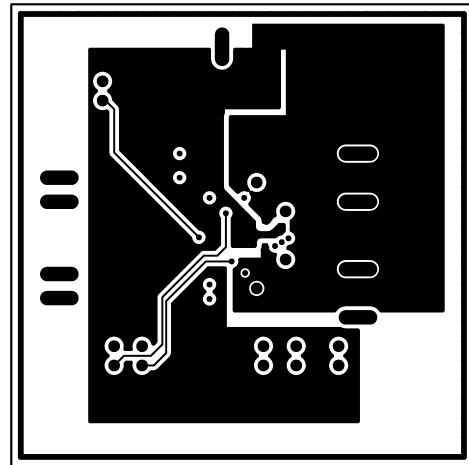

Figure 27. Layer 2

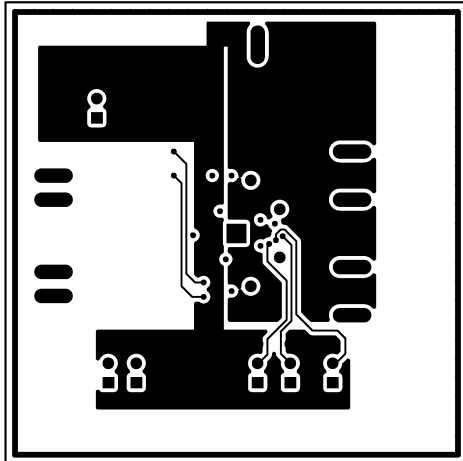

Figure 28. Layer 3

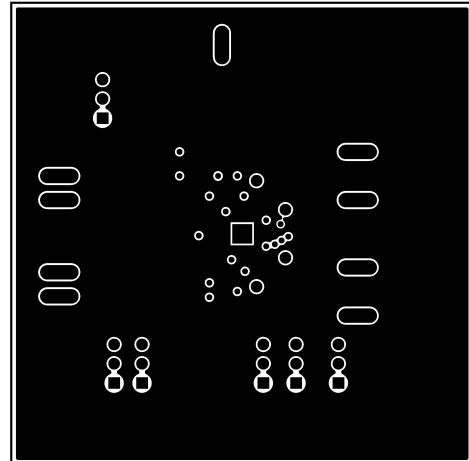

Figure 29. Bottom Layer

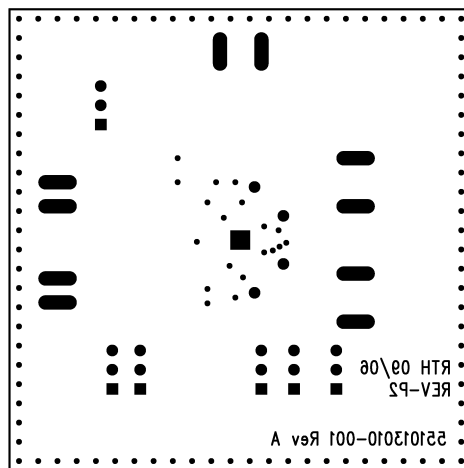

Figure 30. Bottom Silkscreen

REVISION HISTORY

Rev	Date	Description
1.0	02/21/07	Initial release.
1.1	03/19/07	Text edits.
1.2	07/11/07	Added the demo boards and schematic diagram.
1.3	02/22/08	Fixed the PID (product folder).
1.4	04/29/08	Text edits.
1.5	07/03/08	Text edits (under SHUTDOWN FUNCTION).

Changes from Revision D (May 2013) to Revision E

Page

- Changed layout of National Data Sheet to TI format [17](#)

PACKAGING INFORMATION

Orderable Device	Status (1)	Package Type	Package Drawing	Pins	Package Qty	Eco Plan (2)	Lead/Ball Finish	MSL Peak Temp (3)	Op Temp (°C)	Top-Side Markings (4)	Samples
LM48410SQ/NOPB	ACTIVE	WQFN	RTW	24	1000	Green (RoHS & no Sb/Br)	CU SN	Level-1-260C-UNLIM	-40 to 85	L48410	Samples
LM48410SQE/NOPB	ACTIVE	WQFN	RTW	24	250	Green (RoHS & no Sb/Br)	CU SN	Level-1-260C-UNLIM	-40 to 85	L48410	Samples
LM48410SQX/NOPB	ACTIVE	WQFN	RTW	24	4500	Green (RoHS & no Sb/Br)	CU SN	Level-1-260C-UNLIM	-40 to 85	L48410	Samples

(1) The marketing status values are defined as follows:

ACTIVE: Product device recommended for new designs.

LIFEBUY: TI has announced that the device will be discontinued, and a lifetime-buy period is in effect.

NRND: Not recommended for new designs. Device is in production to support existing customers, but TI does not recommend using this part in a new design.

PREVIEW: Device has been announced but is not in production. Samples may or may not be available.

OBsolete: TI has discontinued the production of the device.

(2) Eco Plan - The planned eco-friendly classification: Pb-Free (RoHS), Pb-Free (RoHS Exempt), or Green (RoHS & no Sb/Br) - please check <http://www.ti.com/productcontent> for the latest availability information and additional product content details.

TBD: The Pb-Free/Green conversion plan has not been defined.

Pb-Free (RoHS): TI's terms "Lead-Free" or "Pb-Free" mean semiconductor products that are compatible with the current RoHS requirements for all 6 substances, including the requirement that lead not exceed 0.1% by weight in homogeneous materials. Where designed to be soldered at high temperatures, TI Pb-Free products are suitable for use in specified lead-free processes.

Pb-Free (RoHS Exempt): This component has a RoHS exemption for either 1) lead-based flip-chip solder bumps used between the die and package, or 2) lead-based die adhesive used between the die and leadframe. The component is otherwise considered Pb-Free (RoHS compatible) as defined above.

Green (RoHS & no Sb/Br): TI defines "Green" to mean Pb-Free (RoHS compatible), and free of Bromine (Br) and Antimony (Sb) based flame retardants (Br or Sb do not exceed 0.1% by weight in homogeneous material)

(3) MSL, Peak Temp. -- The Moisture Sensitivity Level rating according to the JEDEC industry standard classifications, and peak solder temperature.

(4) Multiple Top-Side Markings will be inside parentheses. Only one Top-Side Marking contained in parentheses and separated by a "~" will appear on a device. If a line is indented then it is a continuation of the previous line and the two combined represent the entire Top-Side Marking for that device.

Important Information and Disclaimer: The information provided on this page represents TI's knowledge and belief as of the date that it is provided. TI bases its knowledge and belief on information provided by third parties, and makes no representation or warranty as to the accuracy of such information. Efforts are underway to better integrate information from third parties. TI has taken and continues to take reasonable steps to provide representative and accurate information but may not have conducted destructive testing or chemical analysis on incoming materials and chemicals. TI and TI suppliers consider certain information to be proprietary, and thus CAS numbers and other limited information may not be available for release.

In no event shall TI's liability arising out of such information exceed the total purchase price of the TI part(s) at issue in this document sold by TI to Customer on an annual basis.

TAPE AND REEL INFORMATION

QUADRANT ASSIGNMENTS FOR PIN 1 ORIENTATION IN TAPE

*All dimensions are nominal

Device	Package Type	Package Drawing	Pins	SPQ	Reel Diameter (mm)	Reel Width W1 (mm)	A0 (mm)	B0 (mm)	K0 (mm)	P1 (mm)	W (mm)	Pin1 Quadrant
LM48410SQ/NOPB	WQFN	RTW	24	1000	178.0	12.4	4.3	4.3	1.3	8.0	12.0	Q1
LM48410SQE/NOPB	WQFN	RTW	24	250	178.0	12.4	4.3	4.3	1.3	8.0	12.0	Q1
LM48410SQX/NOPB	WQFN	RTW	24	4500	330.0	12.4	4.3	4.3	1.3	8.0	12.0	Q1

TAPE AND REEL BOX DIMENSIONS

*All dimensions are nominal

Device	Package Type	Package Drawing	Pins	SPQ	Length (mm)	Width (mm)	Height (mm)
LM48410SQ/NOPB	WQFN	RTW	24	1000	210.0	185.0	35.0
LM48410SQE/NOPB	WQFN	RTW	24	250	210.0	185.0	35.0
LM48410SQX/NOPB	WQFN	RTW	24	4500	367.0	367.0	35.0

RTW0024A

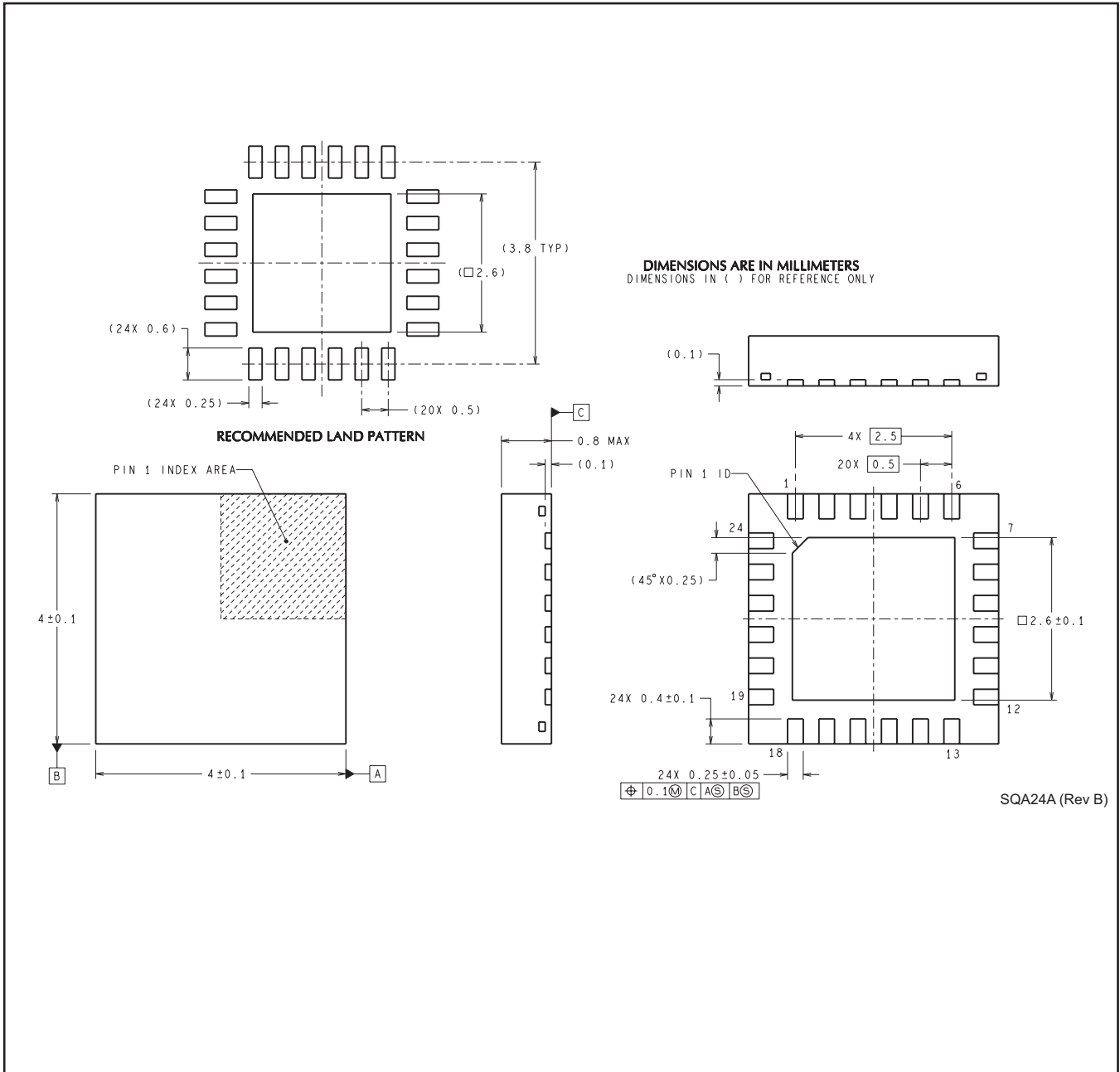

IMPORTANT NOTICE

Texas Instruments Incorporated and its subsidiaries (TI) reserve the right to make corrections, enhancements, improvements and other changes to its semiconductor products and services per JESD46, latest issue, and to discontinue any product or service per JESD48, latest issue. Buyers should obtain the latest relevant information before placing orders and should verify that such information is current and complete. All semiconductor products (also referred to herein as "components") are sold subject to TI's terms and conditions of sale supplied at the time of order acknowledgment.

TI warrants performance of its components to the specifications applicable at the time of sale, in accordance with the warranty in TI's terms and conditions of sale of semiconductor products. Testing and other quality control techniques are used to the extent TI deems necessary to support this warranty. Except where mandated by applicable law, testing of all parameters of each component is not necessarily performed.

TI assumes no liability for applications assistance or the design of Buyers' products. Buyers are responsible for their products and applications using TI components. To minimize the risks associated with Buyers' products and applications, Buyers should provide adequate design and operating safeguards.

TI does not warrant or represent that any license, either express or implied, is granted under any patent right, copyright, mask work right, or other intellectual property right relating to any combination, machine, or process in which TI components or services are used. Information published by TI regarding third-party products or services does not constitute a license to use such products or services or a warranty or endorsement thereof. Use of such information may require a license from a third party under the patents or other intellectual property of the third party, or a license from TI under the patents or other intellectual property of TI.

Reproduction of significant portions of TI information in TI data books or data sheets is permissible only if reproduction is without alteration and is accompanied by all associated warranties, conditions, limitations, and notices. TI is not responsible or liable for such altered documentation. Information of third parties may be subject to additional restrictions.

Resale of TI components or services with statements different from or beyond the parameters stated by TI for that component or service voids all express and any implied warranties for the associated TI component or service and is an unfair and deceptive business practice. TI is not responsible or liable for any such statements.

Buyer acknowledges and agrees that it is solely responsible for compliance with all legal, regulatory and safety-related requirements concerning its products, and any use of TI components in its applications, notwithstanding any applications-related information or support that may be provided by TI. Buyer represents and agrees that it has all the necessary expertise to create and implement safeguards which anticipate dangerous consequences of failures, monitor failures and their consequences, lessen the likelihood of failures that might cause harm and take appropriate remedial actions. Buyer will fully indemnify TI and its representatives against any damages arising out of the use of any TI components in safety-critical applications.

In some cases, TI components may be promoted specifically to facilitate safety-related applications. With such components, TI's goal is to help enable customers to design and create their own end-product solutions that meet applicable functional safety standards and requirements. Nonetheless, such components are subject to these terms.

No TI components are authorized for use in FDA Class III (or similar life-critical medical equipment) unless authorized officers of the parties have executed a special agreement specifically governing such use.

Only those TI components which TI has specifically designated as military grade or "enhanced plastic" are designed and intended for use in military/aerospace applications or environments. Buyer acknowledges and agrees that any military or aerospace use of TI components which have **not** been so designated is solely at the Buyer's risk, and that Buyer is solely responsible for compliance with all legal and regulatory requirements in connection with such use.

TI has specifically designated certain components as meeting ISO/TS16949 requirements, mainly for automotive use. In any case of use of non-designated products, TI will not be responsible for any failure to meet ISO/TS16949.

Products

Audio	www.ti.com/audio
Amplifiers	amplifier.ti.com
Data Converters	dataconverter.ti.com
DLP® Products	www.dlp.com
DSP	dsp.ti.com
Clocks and Timers	www.ti.com/clocks
Interface	interface.ti.com
Logic	logic.ti.com
Power Mgmt	power.ti.com
Microcontrollers	microcontroller.ti.com
RFID	www.ti-rfid.com
OMAP Applications Processors	www.ti.com/omap
Wireless Connectivity	www.ti.com/wirelessconnectivity

Applications

Automotive and Transportation	www.ti.com/automotive
Communications and Telecom	www.ti.com/communications
Computers and Peripherals	www.ti.com/computers
Consumer Electronics	www.ti.com/consumer-apps
Energy and Lighting	www.ti.com/energy
Industrial	www.ti.com/industrial
Medical	www.ti.com/medical
Security	www.ti.com/security
Space, Avionics and Defense	www.ti.com/space-avionics-defense
Video and Imaging	www.ti.com/video

TI E2E Community

e2e.ti.com